

Review

Use of Analog Computers in Anesthetic Research

J. Weldon Bellville, M.D.,* and Hiroshi H. Hara, M.S.†

COMPUTERS today are well-recognized tools of medical research. They can free the researcher's mind and hands to undertake tasks which only a few years ago were overwhelming or impossible. As the physician in the operating room desires more precise information about patient status it is likely that computers will aid in his decisions by providing information otherwise unobtainable. This review is concerned with a description of the theory of one of several computing devices, the analog computer, which is particularly applicable to problems of physiologic data processing encountered by the anesthesiologist.

The analog computer has several advantages over the digital computer. Chief among these are its relatively low cost and the ready availability of essential building blocks so that a small computer designed to solve a specific problem can be fabricated easily by the investigator. Furthermore, with the advent of solid state amplifiers, the space and power requirements are minimal.

History

The analog computer was developed during and shortly after World War II. Because of wartime security measures the credit for its early development is not easily assigned. If any individuals can be credited with the first published use of operational amplifiers as computer elements, they are C. A. Lovall and D. B. Parkinson of the Bell Telephone Laboratories, who used operational amplifiers in the computer of the M-IX anti-aircraft gun director, built by Western Electric Company. J. B. Russell of Columbia University noticed these circuits and brought them to the attention of

Ragazzini, Randall, and Russell, who proceeded to build the first general purpose electronic analog computer.¹ George A. Philbrick also pioneered in the use of high-gain dc amplifiers as computer elements prior to and during World War II.² It should be recalled that in England D. J. Mynall independently developed similar ideas for the use of an operational amplifier as a computing device, and described basic operations such as addition, multiplication, differentiation, and integration.³

Classification

Computing devices may be classified in a variety of ways. They can be thought of mainly as digital or analog devices; in addition a group that has characteristics of both the digital and analog device and are referred to as hybrid (table 1).

TABLE 1

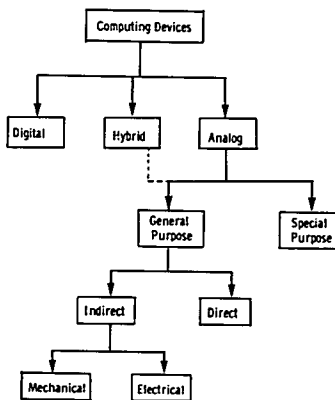

* Professor of Anesthesia, Stanford University School of Medicine, Stanford, California.

† Senior Engineer, Beckman Instruments, Computer Operations, Santa Monica, California.

The analog computer represents the variables of a problem by easily generated or controlled physical quantities, usually electrical voltages. A digital computer, on the other hand, deals with discrete quantities such as notches on a toothed wheel (e.g., desk calculator) or electrical pulses (e.g., electronic digital computer).

The methods of analog computation and digital computation also differ in that with few exceptions the former employs parallel operation (i.e., variety of computing elements are connected simultaneously), while the latter resorts to serial operation (i.e., a variety of computations are carried out sequentially). A hybrid computer on the other hand may be a combination of the two (as in the case of the two types of machines linked via analog to digital (A/D) and digital to analog (D/A) converters, and various data input and control lines).

The analog computer has two distinct advantages over the digital computer. These are an ability to integrate, i.e., determine the area under a curve, and a capacity for rapid problem solution resulting from its parallel structure. Although the present day large scale digital computer can perform such simple arithmetic operations as addition and subtraction in a few micro-seconds, owing to its serial mode of operation, the solution speed will largely depend on the size of the problem. It also can integrate but often serious problems are encountered with the approximate integration of differential equations using numerical techniques.

One drawback of the analog computer is its precision limitation which is at best four significant figures. On the other hand, the precision of the digital computer is in the order of at least eight significant figures; if necessary this can be extended to sixteen significant figures or more.

Analog computers have as a rule been classified as general-purpose or special-purpose machines. A general-purpose machine can be programmed for any number of problems while a special-purpose machine is programmed for a specific problem. Special-purpose or general-purpose analog computers have been used in medical research to define the alveolar ventilation-alveolar P_{CO_2} response curve,^{4,5} for com-

putation of cardiac output from dye dilution curves,^{6,7,8} and to compute compliance work and power of breathing.^{9,10}

General-purpose analog machines are more flexible and have been classified either as direct or indirect. The indirect device may employ mechanical or electrical means to represent variables. Under the direct analog computing classification one finds the equivalent circuit (R-C network), and network analyzers.

Applications

It seems that, in spite of the quick acceptance and widespread use of computers, the greater benefits remain to be realized. Only recently has the analog computer found a place in medical research. Particularly important applications of analog computing machines in medicine lie in three areas: (1) the solution of data processing problems while the data are being generated—"on-line data processing," (2) the simulation of pharmacologic and physiologic phenomena, and (3) the control of bodily processes.

In the solution of on-line data, analog computer results are normally presented graphically as a continuous plot of variable quantities. Thus, it is relatively easy to visualize the results as the actual dynamic response of the physical system under investigation. Since the computations are carried out practically instantaneously and continuously, data processing can be accomplished as fast as they are received. A major portion of this review will be devoted to the application of analog computers to on-line processing.

The simulation problem can be viewed as a problem in which a computer is used to solve mathematical equations which describe the physical process under study. One type of simulation study might be termed "model building," wherein a model is constructed and the parameters adjusted until a known set of data are matched. This is useful in gaining more insight toward the original physical system as well as being an excellent instructional device. By constructing a reasonable model the importance of various parameters can be ascertained; moreover, synthesis of all existing data must be accomplished to test the model. Often it is found that some parameters will

not be anticipated; thus further experiments will be suggested by the model.

When a computer is used as one element in the control of a bodily process, it is subject to a requirement not usually found in solving specific mathematical equations. The rate of operation must correspond to the rate of operation of the system. In solving the specific equations, changes of variable may be made which may alter the time scale of the solution to agree with the limitations of the machine. For instance, in simulating the uptake and distribution of intravenously given thiopental, one second may represent one minute in actual time. In the control of the physical process, data must enter and leave the computer at a specified, generally uniform rate. Thus in this application we are working in actual time. Consequently, computers which are suitable for simulation may be useless for on-line data processing or control processes.

Precision Versus Cost

A problem to consider is the importance of the precision required to obtain a solution to the problem. The machine precision required depends largely on the mathematical aspects of the computation. It is often stated that a digital computer can be as precise as desired, while an analog computer is at best precise to four places. The first remark ignores the fact that any practical digital computer is limited to a finite amount of apparatus and a finite computing time; it also ignores the additional computational cost associated with double-precision or triple-precision routines. The second remark neglects the possibility of applying iterative procedures with an analog computer.¹¹ In most investigations in medicine three or four significant figures are sufficient. Finally, it should be noted that the relative cost of various possible computing models should be considered. There is likely to be quite a spread in cost from one type of machine to another. When cost is considered it may happen that the most expensive machine provides the greatest computational value in forms of results per dollar.

Analog computers, if compared to digital computers in terms of relative cost, are much more inexpensive if precision only to 0.1 per cent is desired. However, when higher pre-

cision is desired, that is—above 0.01 per cent—the cost of an analog device will approach the cost of digital device. It may be reasoned that the cost of a digital device increases linearly with precision, while that of the analog device increases almost exponentially with increase in precision.

Description of Components

LINEAR COMPONENTS

The Operational Amplifier. The operational amplifier is the basic building block of an analog computer. A schematic diagram of an amplifying circuit employing an operational amplifier is shown in figure 1: e_z and e_0 represent the input and output voltages, respectively, and A is the gain (amplification) of the amplifier. The characteristics of this amplifier are that it has a high gain (about 10^5), a high input impedance (draws essentially zero input (grid) current), and has low drift. In figure 2, four equal resistors are placed about an operational amplifier as shown in figure 2, the operational amplifier can be used for summation, so that $e_0 = -(e_1 + e_2 + e_3)$.*

It should be noted that instead of using a fixed input resistor (R_1 , R_2 , or R_3) as shown

* We may apply Ohm's law and derive the equation relating inputs e_1 , e_2 , and e_3 to the output e_0 . The amplifier draws essentially zero input (grid) current; therefore, we may write the expression:

$$i_1 + i_2 + i_3 = i_f$$

$$\text{Or: } \frac{e_1 - e_0}{R_1} + \frac{e_2 - e_0}{R_2} + \frac{e_3 - e_0}{R_3} = \frac{e_0 - e_0}{R_f}$$

$$\text{But: } e_0 = \frac{-e_0}{A}$$

$$\text{And: } A \cong 10^5$$

$$\text{or } e_0 \cong 0$$

$$\text{Therefore: } \frac{e_1}{R_1} + \frac{e_2}{R_2} + \frac{e_3}{R_3} = \frac{-e_0}{R_f}$$

$$\text{Or: } -e_0 = \frac{R_f}{R_1} e_1 + \frac{R_f}{R_2} e_2 + \frac{R_f}{R_3} e_3$$

Thus the gain of the operational amplifier is dependent upon the ratio of the feedback resistor, R_f , to the input resistors, R_1 , R_2 , and R_3 .

$$\text{If: } R_f = R_1 = R_2 = R_3$$

$$\text{Then: } e_0 = -(e_1 + e_2 + e_3)$$

A more rigorous derivation can be found in Johnson, C. L.: Analog Computer Techniques, McGraw-Hill Book Company, Inc., New York, 1956.

in figure 2, a potentiometer may be added to perform multiplication by a constant less than 1 (fig. 3). These potentiometers are usually ten-turn, helical, wire-wound types of high resolution and excellent linearity. By means of a vernier or dial, parameters of the problems may be accurately and conveniently set so that the output is a function of the input, potentiometer setting, input resistor R_2 , and feedback resistor R_f . Thus, in practice, a fraction of the input between 0 and 1 may be selected. If, however, R_f is 10 times R_2 , a constant between 0 and 10 times the input can be obtained.

If a condenser, C , is substituted for the feedback resistor R_f , the operational amplifier can be used as an integrator to define the area under a curve (fig. 4). Thus, the output voltage

$$e_o = \frac{-1}{T} \int_0^t e_i dt + k$$

where $T =$ the product of the input resistor and feedback condenser (RC). This represents the integral of the input voltage plus a constant.

From this it follows that an integrator is the one component that is mode sensitive. By this it is meant that the output characteristics are determined by the mode or state of operation of the computer. The usual modes are *initial condition*, *hold*, and *compute*. The schematic of figure 5 can be used to explain the operation of the integrator in these modes. In the *initial condition* mode the signal impressed on the IC terminal is also sent across the condenser C . If the integrator is then placed in the *compute* mode the condenser, C , bears this initial charge and this is represented by " k " in the equation above. In the *compute* mode the

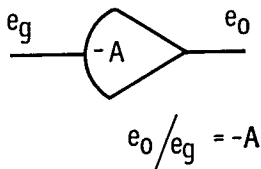

FIG. 1. Schematic of amplifier showing input or grid (e_g) voltage and output voltage (e_o) and amplifier gain (A).

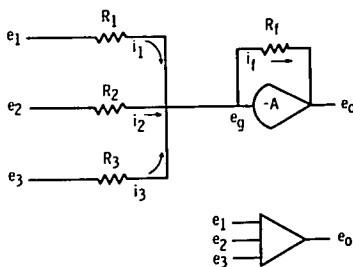

FIG. 2. Schematic of amplifier used as a summer where $e_o = -(e_1 + e_2 + e_3)$. Shorthand notation for this circuit is shown in lower right corner.

integrator will integrate the input and add it to the initial condition value. If the input voltage e_i is constant, the output voltage will increase linearly with time—another way of saying that the area of a rectangle of constant height is linearly related to the length of the base. At any time during the solution of a problem the integrator may be put into the *hold* mode. The value across the condenser at that time is held (it can not discharge through the amplifier), or remembered, and can be read out on a voltmeter. Thus, by utilizing the *hold* mode, an integrator can be used to "remember" a voltage. In figure 5 we have also drawn the common schematic notation for an integrator, a combined rectangle

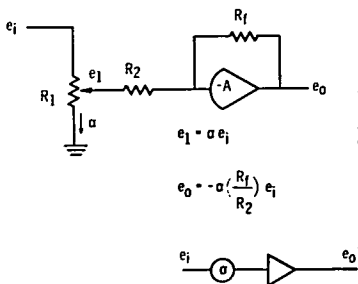

FIG. 3. Schematic of amplifier using a potentiometer input so that multiplication by a constant can be achieved. Shorthand notation is shown in lower right corner.

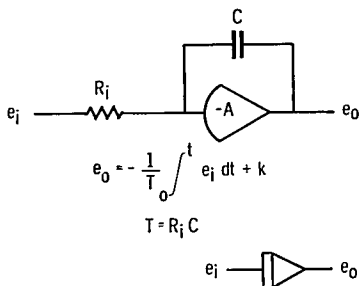

FIG. 4. Schematic of amplifier used as an integrator. Shorthand notation shown in lower right corner.

and triangle. The inputs and initial condition (IC) terminal are shown.

Often it is desirable to measure time between two events; for instance, two successive R waves on an ECG. A voltage proportional to time can be generated by integrating a constant voltage. Thus, when the computer is placed in the *compute* mode, linearly increasing voltage will be generated with time. When the time to be measured is known to fall within certain limits, it is desirable then to have these limits set by the scale factors so that the upper limit is as large as possible but does not exceed the 100 volts upper limit of the operational amplifier. In other words, it is desirable to choose the scale factors to keep the voltage small enough so that the equipment does not overload, but large enough so that sufficient accuracy in measurement is obtained.

An operational amplifier may also be used to construct a differentiator to find the slope of an input curve. This is accomplished by putting a condenser, C, on the input in place of the input resistor, R_1 , and retaining the feedback resistor, R_f (Fig. 6). In this situation,

$$e_o = -T \frac{de_i}{dt}$$

again where $T = RC$. This circuit produces the inverse time derivative of the input signal, e_i , so that if e_i is constant, $e_o = 0$, and if e_i is

increasing, e_o is negative, while if e_i is decreasing, e_o is positive. Since differentiation will decrease signal-to-noise ratio while integration produces the opposite effect, complex systems are best handled making minimum use of the differentiation operation. However, because such a circuit produces, for example, a pulse (blip) from a step, it has many instrumental applications not normally termed computing.

NONLINEAR COMPONENTS

Often it is necessary to multiply one variable, x , by another, y , to obtain the product xy . If x and y are both changing with time then it is necessary to use a multiplier for this operation rather than a potentiometer which will multiply a variable by a constant. For instance, one may have available a voltage representing differential airway pressure and a voltage representing air flow and desire

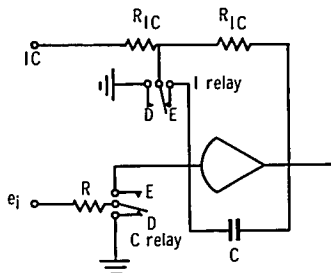

Int. mode / Relay	IC	Comp	Hold
I	E	D	D
C	D	E	D

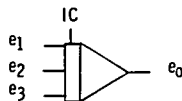

FIG. 5. Integrator circuit showing initial condition (IC) terminal and IC Relay (I) and Compute Relay (C). Table in lower right corner indicates relay position (Energized = E, Deenergized = D) in each integrator mode. (See text.)

obtain their product, the power of breathing. Since both signals vary with time (neither is constant) a multiplier must be employed to obtain this product.

Servo Multipliers. Many types of multipliers have been proposed and built in the past few years, but all until recently presented major disadvantages. In fact, as recently as 1953 the first stabilized, high-speed function multipliers became commercially available. The new all-electronic multipliers offer accuracies of 0.1 per cent or better, and frequency characteristics compatible with the linear components. The two types of multipliers available are the servo multiplier which is most commonly used and the older type of multiplying device, and the newer electronic multiplier. The servo multiplier is a device which operates by positioning of identical potentiometers proportional to a voltage applied to the input of the servo. The accuracy of the device in terms of dc. is limited only by the linearity of the potentiometer. The present limitation due to manufacturing tolerances is approximately 0.025 per cent of full scale, for ten-turn potentiometers. The frequency response characteristics of high precision servo multipliers are poor and, in most instances, provide an upper limit of a few cycles per second to the speed of solution of problems. The operation of a servo multiplier in performing the function of multiplication is easily understood by consulting figure 7. When a constant voltage is applied to the servo input, voltage W , the servo motor will drive the followup potentiometer by a system of gearing by such position that, W volts are picked up by the wiper

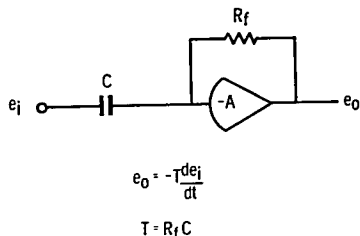

FIG. 6. Schematic of an amplifier used as a differentiator.

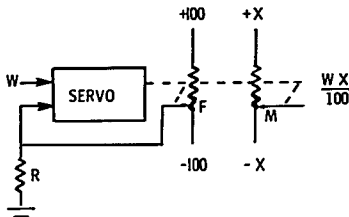

FIG. 7. Block diagram of servo multiplier with inputs X and W .

of the followup potentiometer, F . At that time the servo motor will come to a halt because the error signal generated by a null detecting network at the input of the servo amplifier is zero. Consider now the followup potentiometer, F . Since the followup potentiometer is linear, $+100$ and -100 volts are applied to the ends of the potentiometer, and no current is drawn from the potentiometer wiper at the null position. The only position at which the potentiometer wiper can have or "pick up" W volts is $W/100$ of the distance from the center to the positive end of the potentiometer. This is easily visualized if one keeps in mind that the voltage of the geometrical center of the potentiometer is zero, because of the equal but opposite sign ± 100 volts placed at the ends of the followup potentiometer. The multiplier potentiometer is connected by means of a common shaft or by gears to the followup potentiometer. Thus the wiper of the multiplier potentiometer is positioned to a position $W/100$ of the voltage X , so that the output from the followup is a product of the two variables, W and X , divided by 100. This description of the servo multiplier given for a constant input voltage, W , can be extended, if W is a continuous varying function. The major requirement placed on the input function W is that it must vary sufficiently slowly so that the servo may at all times remain accurately positioned proportional to voltage, representing the function W . A typical upper frequency limit is, therefore, a few cycles per second.

The Quarter-Square Multiplier. In addition to the servo multipliers, there are several electronic multipliers available. One type is the

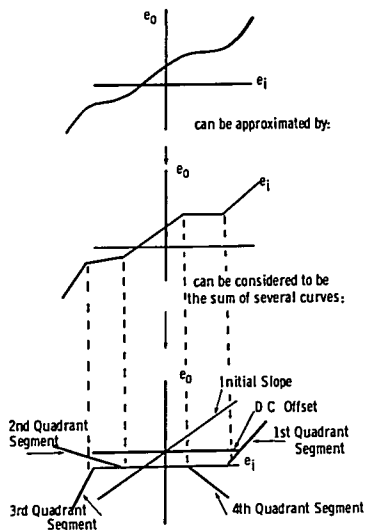

FIG. 8. Illustration of synthesis of an arbitrary function by a series of straight line segments.

quarter-square multiplier. The name comes from the equation that is mechanized in performing the multiplication. The equation is the identity,

$$XY = 1/4 [(X + Y)^2 - (X - Y)^2]$$

It is apparent from this equation that if X and Y can be summed and squared and their difference squared, then the product of XY is easily obtained. Electronic squaring of a number is fairly straight forward so that this identity is made use of to obtain the product XY .

Time-Division Multiplier. Another type multiplier is the time-division multiplier. To create the XY product, the time-division multiplier incorporates a time-division system. A rectangular wave carrier is so generated that applying the X term varies the carrier height or amplitude; applying the Y term varies the width or time of the positive half cycle. The carrier is then filtered and the resultant aver-

age voltage level is proportional to the height-width relationships of the on-time half cycle or to its area.

Function Generators. Frequently it becomes necessary to introduce arbitrary functions into a problem. The requirement may arise from the need to represent nonlinear effects or to introduce a particular function into a problem. The latter may be useful in medical work in taking a nonlinear function such as the output of an infra-red carbon dioxide analyzer and, with the appropriate function establishing a linear relation between voltage and carbon dioxide concentration. Also, if a strain gauge or a pneumotachograph is operated over a nonlinear range, it can be made to appear linear. While there are several types of function generators, only one will be discussed here.

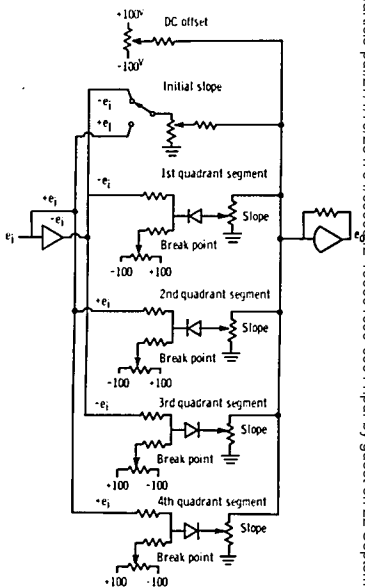

FIG. 9. Schematic illustrating how first four segments of the curve in figure 8 can be generated. Note slope and breakpoint setting for each segment.

Diode-Type Arbitrary Function Generating Equipment. Diode-type arbitrary function generating equipment has become increasingly popular. Increased popularity of diode-function generators can be attributed to several desirable features: first, the ease with which they can be set up to generate a function; second, good frequency response; third, relatively low cost; fourth, good fidelity of reproduction. The diode-function generator generates the desired arbitrary function by a series of straight-line segment approximations. The number of straight-line segments usable and the representation of breakpoints vary from 5 to 21, depending on the type of manufacture. The function generators are supplied in two forms with variable voltage breakpoints and with fixed voltage breakpoints. A breakpoint is the point of intersection between two straight-line segments comprising a portion of the curve. Variable break-point generators have the advantage of greater flexibility and, in general, closer representation of functions having a large curvature. The circuitry of the variable break-point function generators is slightly more complex; correspondingly the function generator is more expensive. Reference to figures 8 and 9 will help explain the operation of the diode function generator.

Special Purpose Circuits. Circuits have been developed to perform many mathematical manipulations of a voltage. Circuits to generate exponential decays, power laws (root laws), absolute values, peak followers, time delays and many others have been described.

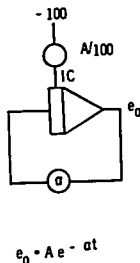

FIG. 10. Circuit employing an integrator and two potentiometers for generating an exponential decay.

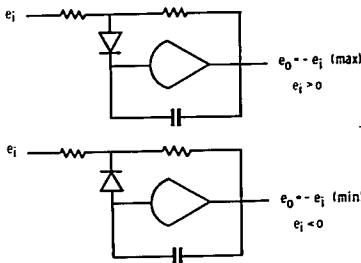

FIG. 11. Circuits employing a diode for detecting and holding the maximum or minimum value of a function.

An exponential decay may be generated by placing a potentiometer about an integrator (fig. 5), as shown in figure 10. The initial value is impressed on the initial condition (IC) terminal. When the integrator goes into the compute mode, the voltage on the condenser will decrease in an exponential manner, and the rate of decrease (slope) will be governed by the value of the potentiometer.

Diodes are usefully employed in designing special circuits. The ideal diode has zero resistance to current in one direction and infinite resistance in the opposite direction. A diode may be placed about an operational amplifier to make peak voltage followers, as shown in figure 11. In this case the condenser about the operational amplifier may charge to a peak positive value (or negative) but remembers the peak value impressed upon it (since its discharge path is blocked by the infinite resistance of the diode). Similarly, if one desires the absolute value of a voltage the circuit employing two diodes and two amplifiers shown in figure 12 may be employed.

Switching Devices: Operational Relays. An operational relay (fig. 13), which is sometimes referred to as a comparator, is often used as a decision making element in analog computation. Its function is to note the sign of the sum of the input voltages and to determine the state of the output relay; that is, when the sum of the inputs is zero or positive, the relay is de-energized, and when the sum becomes negative it is energized. By use of relay con-

Downloaded from http://asa2.silverchair.com/anesthesiology/article-pdf/27/1/70/284764/0000542-19660100-00011.pdf by guest on 22 September 2023

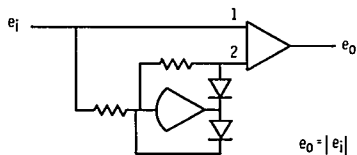

FIG. 12. Circuit employing a summer (note one input has a gain of $\times 2$) and amplifier (plus diodes and resistors) for determining the absolute value of a function.

tacts, so called branching operations are implemented. Operational relays are also useful for the control of the integrator modes in on-line applications. For example, controlling the onset and end of a computation is often essential—the operational relay can do this. Thus we desired to integrate flow as soon as exhalation started, *i.e.*, as soon as flow (e_1) became greater than zero.⁴ This was accomplished with an operational relay type circuit, whereby, as soon as exhalation began, flow was measured by a negative going signal. As the signal became negative by more than 1 mv., the relay energized and its contacts placed the integrator in the integrate or compute mode. In operation it was necessary to set the reference voltage, e_r , to one millivolt. In this way pulsations from the heart (less than 1 mv. peak) transmitted to the pneumotachograph through the air column in the trachea would not trigger the operational relay. Thus, when the flow signal exceeded 1

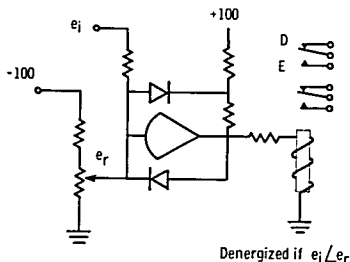

FIG. 13. Schematic of an amplifier and associated circuitry necessary to make an operational relay. Note: the relay is deenergized if $e_i < e_r$.

millivolt the relay closed and integration started.

Analog Readout Devices. One of the most important problems is to enter the input and to read the output of the analog computer accurately. For the case of static input and output (*e.g.*, entering coefficient potentiometer settings and reading out the final output voltage), a precision digital voltmeter can be utilized. However, another method which is used frequently is the use of a deflection type null meter to compare the voltage read against an adjustable reference voltage (this can be a reference potentiometer or more commonly a Kelvin-Varley-type voltage divider).

Dynamic output (varying voltages as functions of time) are recorded via an XY plotter or a strip chart recorder. Often the results are observed on an oscilloscopic cathode ray tube; such a device with a memory type tube or camera attachment is most useful.

Simulation

Although this review is concerned for the most part with the components and application of analog computers to on-line data processing, it is appropriate to discuss the use of the analog computer for the simulation of physiologic processes.

A technique which is commonly used is to describe first the process to be simulated by means of a set of mathematical equations (usually ordinary differential equations), then to program the analog computer to solve these equations. Thus the method consists of two phases: the construction of a mathematical model and computer mechanization of the equations developed in the mathematical model.

Although the end results are essentially identical to that of the latter method, there is another technique by which the simulation problem can be studied. This may be called "computer modeling." As the name implies, the computer model of the physical process under study is built directly, without explicitly formulating a set of mathematical equations. The concept is identical to that upon which the "analog approach"¹² is based. By far the most popular method employed in the "analog approach" is the study of a physical system by

TABLE 2

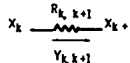
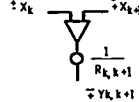
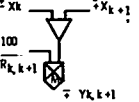
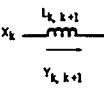
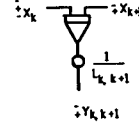
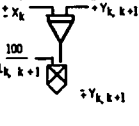
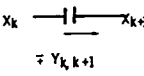
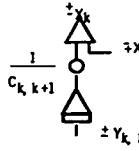
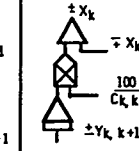
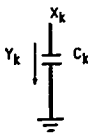
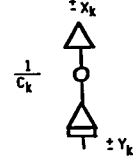
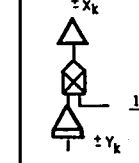
Module	Equations	Computer simulation module	
<p>Resistance module</p> 	$Y_{k,k+1} = \frac{X_k - X_{k+1}}{R_{k,k+1}}$	<p>$R_{k,k+1}$: Constant</p> 	<p>$R_{k,k+1}$: Variable</p> 
<p>Inductance module</p> 	$Y_{k,k+1} = L_{k,k+1} \frac{d(X_k - X_{k+1})}{dt}$	<p>$L_{k,k+1}$: Constant</p> 	<p>$L_{k,k+1}$: Variable</p> 
Module	Equations	Computer simulation module	
<p>Capacitance module</p> 	$X_k - X_{k+1} = \frac{1}{C_{k,k+1}} \int Y_{k,k+1} dt$	<p>$C_{k,k+1}$: Constant</p> 	<p>$C_{k,k+1}$: Variable</p> 
<p>Special case of $X_{k+1} = 0$</p> 	$X_k = \frac{1}{C_k} \int Y_k dt$		

constructing an electrical analog of the original system. In recent years numerous articles have been published in which electrical analogs or models have been used to describe various physiologic phenomena. For instance, in the study of circulation of blood an electric analog of the circulation can be built by permitting electrical voltage, current, charge, resistance, and capacitance, to represent blood pressure, blood flow, blood volume, resistance

to blood flow, and compliance of the ventricles and blood vessels, respectively.¹³ In addition, attempts at simulation of uptake and distribution of anesthetic agents have been made.

Because electric resistors, capacitors, and the like are used to represent physical elements, it is also possible to construct computer circuits to represent physical elements. When the electric resistors and capacitors are interconnected to construct an electrical analog

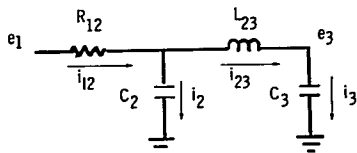

FIG. 14. Typical R-C-L circuit that might be used to simulate a physical system.

model of the physical process, these computer circuits or "computer simulation modules" † can be interconnected to make up a computer model of the process under study. Each module, therefore, can be thought of as a replacement for an electrical element in the electrical analog.

Three types of "computer simulation modules" are most useful: the "resistance module," the "inductance module," and the "capacitance module." These names are derived from the passive electrical elements in electrical analogs. The schema of these modules are depicted in table 2. Although familiar electrical elements are employed in the first column to suggest the various elements, it might be more appropriate to consider them as symbolic representations of any physical element whose

† To the author's knowledge, this idea was originated by Dr. M. C. Gilliland of Beckman/Computer Operations when he applied the method to the simulation of lumped electrical, mechanical, and thermal systems.

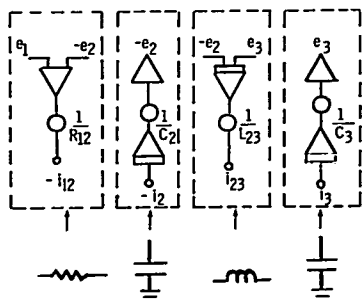

FIG. 15. Analog simulation modules that correspond to the analogous components in figure 14.

behavior is governed by the corresponding equation in the second column. For example, the inductance module may represent a mechanical spring, in which case, X corresponds to velocity, Y to force, and L to the spring constant. The X is used to represent *node* quantities while Y is used to represent *through* variables. For example, in the case of an electrical system, X represents electrical potential or voltage while Y represents electrical current or charge flow; in the case of a thermal system, X represents temperature while Y represents thermal current. In the case of a pharmacologic system, X represents concentration of drug while Y represents distribution of drug. Note that in the last column, two separate circuits are shown for each module. The only difference is that potentiometers are replaced by electronic multipliers. The use of a multiplier enables simulation of a variable physical parameter—not easy to accomplish were some other model (like passive electrical model) to be used.

The rule to follow in order to establish interconnection of computer simulation modules is to satisfy the law that—all the *through* variables must add up to zero at a given node (In the case of an electrical system, this law is known as Kirchhoff's law of current); or other words, what comes into a node must go out. This can best be illustrated by the following example.

Consider an electrical circuit as shown in figure 14. In reference to table 2 computer simulation modules are laid out as shown in figure 15. Note that the layout of the com

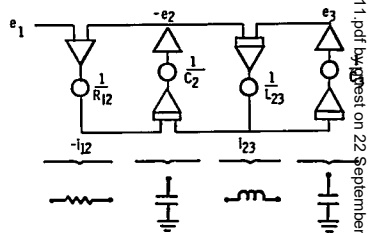

FIG. 16. Intermediate and final analog simulation diagram of schematic shown in figure 14. (See also table 2.)

Downloaded from ascelibrary.org by Seattle University on 09/22/14. Copyright ASCE, For All Rights Reserved, No part of this document may be reproduced, stored in a retrieval system, or transmitted, in any form or by any means, electronic, mechanical, photocopying, recording, or by any information storage and retrieval system, without permission in writing from the American Society of Civil Engineers.

puter simulation modules have a one-to-one correspondence to the original system. Also note that signs are chosen such that adjacent nodes have opposite polarities; this is done merely to conserve on equipment (since most operational amplifiers invert the sign). There are instances where this may not be possible, in which case insertion of an operational amplifier in the appropriate location will provide the necessary inversion of sign. What follows is obvious in figure 16; that is, $-e_2$ appears as the output of C_2 circuit, and since $-e_2$ must be the same, the two points are connected. In order to complete the interconnection, the aforementioned rule must be followed. At the second node, what comes in (i_{12}) must equal what goes out ($i_2 + i_{23}$). That is:

$$i_{12} = i_2 + i_{23}$$

or:

$$-i_2 = -i_{12} + i_{23}.$$

Therefore, all that is to be done is to sum $-i_{12}$ and i_{23} into the input of the integrator, in the C_2 circuit. Fortunately, these two quantities are available as outputs of R_{12} and L_{23} circuits, respectively, and at the third node, $i_3 = i_{23}$. Hence, the final diagram was that shown in figure 16. Again, note that the original system can be visualized by merely looking at the final computer circuit.

Now let us take another example which might be more closely related to anesthesia. Suppose one is interested in building a compartmental model to study the uptake and distribution of drugs.† In this case, the model quantity, X , is the drug concentration (in mg./ml.) and the through variable, Y , is the drug distribution (in mg./sec.). Let w denote the concentration of the drug and W , the amount of drug in a compartment with volume, V . Then,

$$w = \frac{W}{V}$$

Now, if we allow the drug flow between compartments to be f , then between the k th and

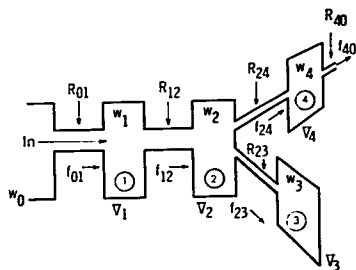

FIG. 17. Block diagram of organization of possible compartment model to study uptake and distribution of a drug.

$(k + 1)$ compartments,

$$f_{k,k+1} = \frac{W_k - W_{k+1}}{R_{k,k+1}}$$

where $R_{k,k+1}$ is the diffusion constant.

Also,

$$W_k = \int (\sum_i f_{i,k} - \sum_j f_{k,j}) dt$$

or

$$w_k = \frac{W_k}{V_k} = \frac{1}{V_k} \int (\sum_i f_{i,k} - \sum_j f_{k,j}) dt$$

It can be seen that the equations for f and w are identical to those for the resistance and capacitance modules. Therefore, if we are interested in simulating the compartmental

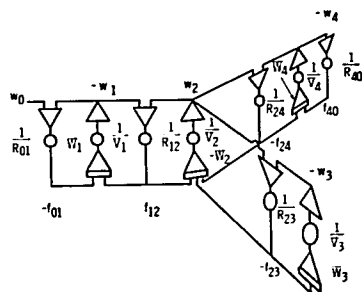

FIG. 18. Analog computer simulation of compartment model shown in figure 17.

† See also paper by Gerald Fleischli and Ellis N. Cohen on page 64.

model shown in figure 17, the computer diagram shown in figure 18 would follow: again the pictorial one-to-one correspondence is retained.

It should be pointed out at this point that the method presented here is only one way to approach the problem of computer simulation of physiologic systems. Although analog computers are classified as indirect computing devices because of the manner in which they are utilized (*i.e.*, solution of differential equations), the method discussed brings the analog computer a little closer to the original physical system, in the same fashion that one can draw a passive electrical analog of the original system without writing all the necessary equations. We by no means discourage anyone from taking the conventional approach to passive circuit simulation, but hope that this brief discussion has illustrated how relatively easy it is to use an analog computer for physiologic simulation. At the same time we wish to emphasize two advantages the analog computer affords over the passive circuit simulation. First, voltages can be measured at any point without loading or otherwise disturbing the function of the model, or the problem can be stopped at any moment (by going into the Hold mode) and all voltages measured. Second, the analog computer is extremely flexible and nonlinear properties can easily be introduced into the problem. An example of this would be to simulate the varying volume of the ventricles during their contraction, as mentioned above.¹³

Summary

The computer has been widely accepted in the world of today. It is extensively used in business, engineering, government, and space flight applications. The role of the computer in medical research, although recognized as potentially important, remains, for many disciplines, virtually unexplored. The present review is directed specifically to computation by analog techniques, which afford many advantages over digital computers in on-line data processing, simulation, and in control process. The use of the analog computer for the solution of these three types of problems is exemplified in work currently in progress in the Anesthesia Laboratories at Stanford Univer-

sity. These studies include the on-line data processing: of cardiac output from dye dilution curves;⁸ measurement of stroke volume from the ballistocardiogram based on the Starr,¹³ Klensch,¹⁶ and Nickerson¹⁷ formulas; analysis of work and power of breathing;¹⁴ and power spectral analysis of Korotkoff sounds. The use of the analog computer in simulation studies has found ready application to studies on drug uptake and distribution,¹⁸ one example of which has been described in this issue.¹⁹ (Another example will appear in a future article.²¹) In addition, the analog computer has been used in studies wherein the analog controlled the experiment and analyzed the data, on-line;²⁰ that is, it controlled the sinusoidal infusion of norepinephrine and performed a Fourier analysis on the blood pressure response.

It is recognized that computers are powerful research tools, but, unless investigators are aware of the attributes of analog, hybrid, and digital computing devices, optimal use of these devices will not be made. For instance, pre-processing of analog data may be desirable even before recording on a strip chart recorder, rather than computing data from the strip chart records. With the advent of solid state operational amplifiers some pre-processing may be built into recorder pre-amplifiers so that the planimeter found in many laboratories is now obsolete. Even more important is the necessity for pre-processing of analog data before going into a digital computer, to avoid saturation of computer core memory and waste of digital computer time. This is effectively done by hybrid computers which combine the advantages of the analog and digital computers. The reader is referred to Macy's article for a discussion of hybrid computers.¹⁴

Major advances in computer science and technology will be made during the next few years. The trend now is toward solid state analog components with increased reliability and lower power and space requirements. This, coupled with the advent of monolithic (or integrated) circuits and time sharing in digital computers, means that on-line data processing and control of anesthesia, thought economically impractical ten years ago, are now only a little bit over the horizon. Thus, the

methods being developed for research today will be applicable to patient care tomorrow.

References

1. Ragazzini, J. R., Randall, R. H., and Russell, F. A.: Analysis of problems in dynamics by electronic circuits, Proc. IRE 35: 444, 1947.
2. Philbrick, G. A.: Designing industrial controllers by analog. Electronics, 21: 108, 1948.
3. Mynall, D. J.: Electrical analog computing, Elect. Engin. 19: 178, 1947.
4. Bellville, J. W., and Seed, J. C.: Respiratory carbon dioxide response curve computer, Science 130: 1079, 1959.
5. Bellville, J. W., Gilliland, M. C., Hara, H. H., and Mower, W. E.: Respiratory carbon dioxide response curve computer, Med. Electron. Biol. Engin. 1: 217, 1963.
6. Skinner, R. L., and Gehnilick, D. K.: Analog computer aids heart diagnosis, Electronics 32: 56, 1959.
7. Moody, N. F., Barber, H. D., Holmlund, B. A., and Merriman, J. E.: A cardiac output computer for the rapid analysis of indicator dilution curves, Med. Electron. Biol. Engin. 1: 203, 1963.
8. Hara, H. H., and Bellville, J. W.: On-line computation of cardiac output from dye dilution curves, Circ. Res. 12: 379, 1963.
9. Engstrom, C. G., and Norlander, O. P.: A method for analysis of the actual power of gas flow, pressure and time, Acta Anaesth. Scand. 6: 49, 1962.
10. Fletcher, G., and Bellville, J. W.: On-line computation of the mechanics of breathing, J. App. Physiol.
11. Wadel, L. D.: Automatic iteration on an electronic analog computer, Proc. Wescon, p. 13, 1954.
12. Karplus, W. J.: Analog Simulation. New York, McGraw-Hill, 1958, pp. 7-16.
13. Defares, J. G., Hara, H. H., Osborn, J. J., and McLeod, J.: Theoretical analysis and computer simulation of the circulation with special reference to the Starling properties of the ventricles. Circulatory Analog Computers, Edited by A. Noordergraaf, G. N. Jager, N. Westerhof. Amsterdam, North-Holland Publishing Company, 1963, pp. 91-122.
14. Macy, J., Jr.: Hybrid computer techniques for physiology, Ann. N. Y. Acad. Sci. 115: 569, 1964.
15. Smith, N. Ty, and Corbascio, A. N.: Estimation of stroke volume by analog computer solution of the Starr ballistic formula, Proc. First World Congress Ballistocardiography and Cardiovascular Dynamics, In Press.
16. Hugin, W.: Ballistocardiographic experiments into some problems of anaesthesia, Brit. J. Anaesth. 34: 696, 1962.
17. Nickerson, J. L.: Estimation of stroke volume by means of the ballistocardiograph, Amer. J. Cardiol. 2: 642, 1958.
18. Hart, H. E. (ed.): Multi-compartment analysis of tracer experiments, Ann. N. Y. Acad. Sci. 108: 1, 1963.
19. Fleischli, G., and Cohen, E. N.: An analog computer simulation for the distribution of d-tubocurarine, ANESTHESIOLOGY 27: 64, 1966.
20. Fleischli, G., and Bellville, J. W.: Servo-analytic studies of cardiovascular control using sinusoidal nor-epinephrine infusions, Proc. San Diego Sympos. Biol. Engin. 4: 78, 1964.
21. Saidman, L. J., and Eger, E. I., II: The effect of thiopental metabolism on duration of anesthesia, ANESTHESIOLOGY, In press.

ELECTRONARCOSIS Blood 17-oxycorticosteroids and urinary adrenaline and noradrenaline levels were studied in the course of various operations performed under electronarcosis induced by means of interferential currents. The results were compared with data obtained in analogous operations carried out under ether-oxygen anesthesia. Whereas blood 17-oxycorticosteroid levels are higher in ether-oxygen anesthesia, the urinary concentration of catecholamines is higher in electronarcosis. This is attributed to more intense stimulation of the sympathetic-adrenal system by the electric current. The noradrenaline level after an operation performed under ether-oxygen anesthesia does not differ from the preoperative level. After termination of electronarcosis, however, it falls below normal, which seems to explain the occurrence of collapse in the immediate postoperative period associated with this form of anesthesia. Slow progressive reduction of current intensity may prevent this complication. (Zhukovskii, V. D., and others: Variations of Suprarenal Function During and After Electronarcosis (Russian), Eksper. Khir. Anesteziol. 1: 77 (1965.))