

The Relationship of Age to the Pharmacokinetics of Early Drug Distribution: The Concurrent Disposition of Thiopental and Indocyanine Green

Michael J. Avram, Ph.D.,* Tom C. Krejcie, M.D.,† Thomas K. Henthorn, M.D.‡

The optimal dose of thiopental depends both on its initial distribution kinetics, which determine its concentrations at sites of action after iv administration, and on its pharmacodynamics. The disposition of concomitantly administered thiopental and indocyanine green (ICG), a marker of intravascular space, was determined in 21 patients, aged 20-80 yr, to determine the pharmacokinetic basis of increased reactivity of the elderly to thiopental. Data obtained from frequent early arterial blood samples and the simultaneous modelling of thiopental disposition with that of ICG allow a rigorous description of early drug distribution. Their disposition is described by a two-compartment ICG model and a four-compartment thiopental model that have a common central volume, V_1 , the central blood pool. ICG distributes, by intravascular mixing, from V_1 to a peripheral blood volume that is a subset of a rapidly equilibrating (fast) peripheral thiopental compartment; elimination clearance of both drugs is modelled from these peripheral compartments. In contrast to the results of others, the results of this study demonstrate that V_1 does not decrease with increasing age. The only pharmacokinetic variable that changed with age is the intercompartmental clearance (Cl_{21}) from V_1 to the rapidly equilibrating peripheral volume, V_2 , which decreased 35% between the ages of 20-80 yr. The authors suggest that V_1 and the intercompartmental clearances may be used together to explain smaller dose requirements in individuals with increased reactivity to thiopental; such an analysis does not predict that dose adjustments should be made on the basis of age alone. (Key words: Anesthetics: intravenous; thiopental. Pharmacokinetics. Thiopental: age factors.)

OLDER PATIENTS may require lower doses of thiopental for induction of anesthesia than do younger adult patients.¹⁻⁴ Increased reactivity of the elderly to thiopental

This article is accompanied by an editorial. Please see: Hull 72:399-402, 1990.

* Associate Professor of Anesthesia.

† Assistant Professor of Clinical Anesthesia.

‡ Assistant Professor of Anesthesia.

Received from the Northwestern University Medical School, Department of Anesthesia, 303 E. Chicago Avenue, Chicago, Illinois 60611. Accepted for publication September 26, 1989. Supported in part by an American Society of Anesthesiologists Research Starter Grant and the Puritan-Bennett Foundation. Presented in part at the Annual Meeting of the American Society of Anesthesiologists, Atlanta, Georgia, October 10-14, 1987, and the 9th World Congress of Anesthesiologists, Washington, D.C., May 22-27, 1988.

Address reprint requests to Dr. Avram.

must be due to age-related changes in either the pharmacodynamics or the pharmacokinetics of thiopental. Christensen and associates found no differences in plasma thiopental concentrations associated with the onset of hypnosis in young and elderly patients despite lower induction doses in the elderly.⁵ Homer and Stanski found no difference between young and old patients in the relationship between estimated steady-state plasma thiopental concentrations and the frequency below which 95% of the EEG power lies.⁴ Studies seeking to explain increased reactivity of the elderly to thiopental on the basis of pharmacokinetic changes have looked for altered early drug distribution⁴⁻⁶ since sites of thiopental action are exposed to high early drug concentrations.⁷ Nonetheless, these studies have produced conflicting reports on the existence and nature of age-related changes in early thiopental disposition,⁴⁻⁶ perhaps because of the difficulties inherent in describing early drug disposition.⁸⁻¹⁰

The initial volume of distribution or central volume (V_C or V_1) is that volume in which a drug appears to be instantaneously mixed before mixing, flow, and diffusion distribute it throughout the remainder of its distribution volume.¹¹ The V_C of an intravenously administered drug such as thiopental should be related to intravascular space and tissues mathematically indistinguishable from it.^{10,11} Because the peak effect of a standard intravenously administered dose of thiopental wanes before intravascular mixing is complete,^{12,13} the rate and extent of drug distribution during intravascular mixing should affect the intensity and duration of its effect. An assessment of kinetic factors affecting individual reactivity to thiopental should resolve intravascular mixing from early drug distribution. This can be done by characterizing the dispositions of concomitantly administered indocyanine green (ICG) and thiopental with a combined two-compartment ICG/four-compartment thiopental model.¹⁴

The purpose of the present study was to test the hypothesis that prolonged intravascular mixing in the elderly alters the early disposition of intravenously administered thiopental. Alterations in the extent and rate of early tissue distribution as a result of prolonged intravascular mixing could explain the apparent age-related decrease in both

V_C ⁴ and the rate of drug transfer from V_C to a second, rapidly equilibrating volume.⁵ To isolate age as a factor in altered thiopental pharmacokinetics in the elderly, only healthy (ASA physical status 1 or 2) patients were studied.

Methods

SUBJECTS

Twenty-one ASA physical status 1 or 2 male patients participated in this institutionally approved study after providing written informed consent. All patients were scheduled for peripheral, nonvascular operations in the supine position. In order to assure a reasonable distribution of patients over the age range of 20–80 yr, seven patients were included from each of the following age ranges: 20–45, 46–65, and 66–80 yr.

CONDUCT OF THE STUDY

After an overnight fast, patients received an opioid administered intramuscularly alone or in combination with an antisialagogue. Preinduction sedation included fentanyl, 50–250 μ g, or sufentanil, 5–50 μ g, injected through the administration port of an iv administration set through which a crystalloid solution was flowing freely. Anesthesia was induced by manually injecting thiopental, 3 mg/kg, at a constant rate over 15 s through this peripheral venous catheter while ICG, 0.5 mg/kg, was being administered in the same manner into a proximal (cephalic) vein. Vecuronium was administered after induction of anesthesia to facilitate tracheal intubation, which was attempted no earlier than 4.5 min after administration of thiopental. Supplemental vecuronium was administered, as required, for surgical relaxation. Anesthesia was maintained with enflurane, as clinically indicated, in N_2O/O_2 ($F_{I}O_2 = 0.5$). The average \pm SD duration of anesthesia was 3.4 \pm 1.7 h.

A radial artery was cannulated in all patients to facilitate frequent blood sampling during the first hours after drug administration; later blood samples were obtained through the catheter placed in the proximal (cephalic) arm vein. Arterial blood samples were obtained every 30 s from 1–5 min, every minute from 6–16 min, and at 18, 20, 25, 30, 45, 60, 90, and 120 min after the start of thiopental and ICG administration. Subsequent arterial or venous blood samples were obtained hourly until 10 h, and, finally, at 12 h.

LABORATORY METHODS

Plasma ICG concentrations in all samples collected up to 16 min after injection were measured by the spectrophotometric technique of Svensson *et al.*¹⁵ on the day of collection. This method has been shown to produce results

identical to those obtained by high performance liquid chromatography (HPLC) even after multiple doses of ICG.^{15,16} The sensitivity of this assay is 0.5–8.3 μ g/ml with coefficients of variation of 5% or less at all concentrations. Because ICG does not partition into erythrocytes, plasma ICG concentrations were converted to blood concentrations by multiplying them by 1 minus the hematocrit.

Plasma thiopental concentrations in all samples were measured by an HPLC technique designed to minimize thiopental breakdown.¹⁷ The samples were extracted in duplicate with disposable solid phase extraction columns on the day of collection and analyzed within 36 h. The sensitivity of this assay is 0.25–100 μ g/ml with coefficients of variation of 5% or less at concentrations of 0.50 μ g/ml and above. Whole blood thiopental concentrations were taken to be the same as plasma concentrations because the thiopental plasma to red cell partition ratio is one.¹⁸

DATA ANALYSIS

Each patient's blood drug concentration *versus* time data were analyzed separately with the CONSAM/SAAM29 digital computer program^{19,20} that was implemented on a VAX 11/780 computer (Digital Equipment

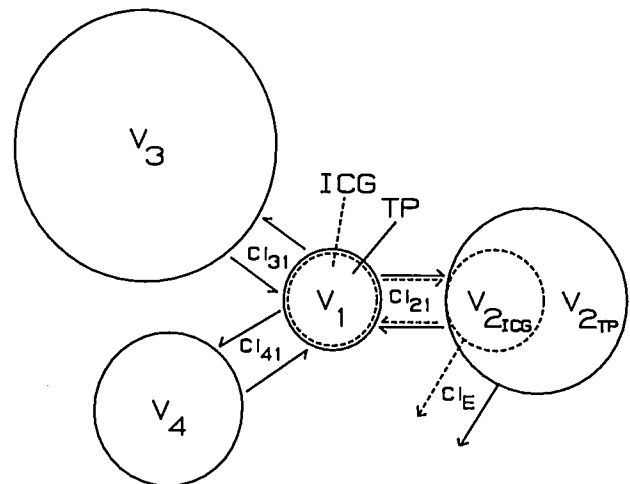

FIG. 1. The concomitant disposition of thiopental (TP, solid lines) and indocyanine green (ICG, dashed lines) was modelled with this compartmental system¹⁴ (see Appendix). The drugs were injected simultaneously into the central, intravascular compartment (V_1) from which they distribute to a peripheral intravascular compartment (V_{2-ICG}) at a rate determined by the intercompartmental clearance (Cl_{21}). From this peripheral intravascular space thiopental freely diffuses to the associated tissues so V_{2-ICG} is treated as a subvolume of V_{2-TP} . The elimination clearance (Cl_E) of ICG and thiopental are modelled from V_{2-ICG} and V_{2-TP} , respectively. Thiopental distributes from blood to other tissue compartments (V_3 and V_4) at rates determined by the respective intercompartmental clearances (Cl_{31} and Cl_{41}). (Reproduced from Henthorn, Avram, and Krejcie¹⁴ with permission).

TABLE 1. Patient Characteristics ($\bar{x} \pm SD$)*

Age Range (yr)	Age (yr)	Mass (kg)	Height (cm)
20-45	31 ± 7	95 ± 25	181 ± 14
46-65	56 ± 7	93 ± 19	176 ± 6
66-80	72 ± 5	88 ± 10	176 ± 6
20-80	53 ± 18	92 ± 18	178 ± 9

* N = 7 in each age range except N = 21 in the 20-80 yr range.

Corporation, Maynard, MA). Drug input into V_1 was modelled as a 15-s zero-order infusion; arterial blood samples were obtained from V_1 . The simultaneous disposition of thiopental and ICG was analyzed with a combined open mammillary model as previously described (fig. 1).¹⁴ Thiopental disposition was described by a four-compartment model and ICG disposition was described by a two-compartment model (see Appendix). The initial intravascular disposition of thiopental was assumed to be the same as that of ICG, which distributes only intravascularly.¹⁴ Potential indices of individual variability in early drug distribution, the sum of the intercompartmental clearances ($\sum Cl_i$)²¹ of thiopental, the mean residence time (MRT) of thiopental in each compartment,²² and the turnover time for V_1 ²² were also calculated for each patient.

The disposition of thiopental alone in each patient was also described using the standard three-compartment open mammillary model.^{4,5,14,23,24} This model was constructed in two ways, using all data and excluding data collected before 3 min in order to ensure that the assumption of complete mixing within the central (intravascular) volume is satisfied.^{11,14,24}

The relationships between body mass and the pharmacokinetic variables and between age and the pharmacokinetic variables as well as other patient characteristics were sought using a standard least squares linear regression technique.²⁵ The criterion for rejection of the null hypothesis was $P < 0.05$.

Results

Demographic data for the patients participating in this study are summarized in table 1. Data in this and subse-

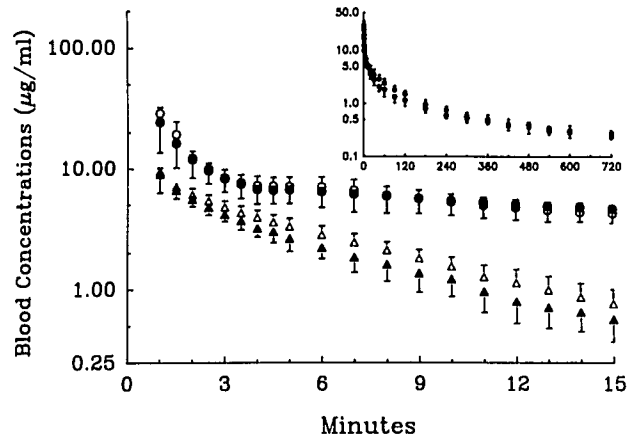

FIG. 2. Mean (and SD) blood thiopental (circles) and ICG (triangles) concentration *versus* time relationships for the 20-45-yr age group (closed figures) and the 66-80 yr age group (open figures). A second ICG compartment and a fourth thiopental compartment could be modelled (fig. 1) as a result of the additional exponential phase revealed by the frequent early arterial blood sampling. The insert represents the thiopental kinetics for the full 12 h of data collection although some of the early data points are not included for the sake of clarity.

quent tables are summarized not only for all 21 patients participating in this study but also for each of the three arbitrarily chosen age groups, each of which contained seven patients. There was no relationship between age and either body mass or height.

The average blood drug concentration *versus* time relationships for both ICG and thiopental are presented for both the 20-45 and 66-80 yr age groups in figure 2. There was very little difference between groups in the thiopental blood concentration *versus* time relationship.

All simultaneously analyzed blood ICG and thiopental concentration *versus* time relationships were well described by the combined two- and four-compartment models, respectively (fig. 1). Over three-fourths of the kinetic variable estimates had fractional SD that were less than 0.2, nearly 90% were less than 0.3, 95% were less than 0.4, and none approached unity.²⁶

The pharmacokinetic variables describing ICG disposition are presented in table 2 and equations describing

TABLE 2. Indocyanine Green Two-Compartment Pharmacokinetic Variables ($\bar{x} \pm SD$)*

Age range (yr)	Volumes (ml/kg)			Clearances (ml · min ⁻¹ · kg ⁻¹)		$t_{1/2\beta}$ (min)
	V_1	V_{2-ICG}	V_{SS}	$Cl_{21} \ddagger \ddagger$	$Cl_E \ddagger$	
20-45	33 ± 5	41 ± 8	74 ± 8	26 ± 9	11 ± 2	4.0 ± 0.8
46-65	37 ± 10	36 ± 10	73 ± 15	22 ± 8	12 ± 3	3.7 ± 0.4
66-80	37 ± 6	38 ± 6	75 ± 7	19 ± 4	9 ± 1	4.8 ± 0.6
20-80	36 ± 7	38 ± 8	74 ± 10	23 ± 7	11 ± 2	4.2 ± 0.8

* N = 7 in each age range except N = 21 in the 20-80-yr range.
† This variable was not related to body mass and is presented in

table 5 not normalized by body mass.
‡ Correlated with age.

TABLE 3. Relationships of Indocyanine Green and Thiopental Pharmacokinetic Variables to Body Mass*

Variable	Slope	Intercept	r
V_1	0.02	1.24	0.58
$V_{2 \cdot ICG}$	0.04	0.14	0.67
$V_{SS \cdot ICG}$	0.06	1.37	0.77
$Cl_{E \cdot ICG}$	0.006	0.37	0.58
$Cl_{E \cdot TP}$	0.003	0.04	0.69

* $P < 0.05$ for all correlations between pharmacokinetic variables and body mass. All other such correlations failed to meet the criterion for rejection of the null hypothesis.

significant correlations with mass and age are presented in tables 3 and 4, respectively. There was a correlation with mass for all of the volume variables describing intravascular space, V_1 , $V_{2 \cdot ICG}$, and $V_{SS \cdot ICG}$, as well as for ICG elimination clearance, but there was no such correlation for intercompartmental clearance, Cl_{21} . However, the intercompartmental clearance of ICG was correlated with age (fig. 3) as was ICG elimination clearance.

The four-compartment description of thiopental disposition (table 5) has two variables in common with the two-compartment description of ICG disposition (table 2), V_1 and Cl_{21} (fig. 1), which were related to mass (table 3) and age (table 4, fig. 3), respectively, as described above. In addition, the elimination clearance of thiopental was related to mass (table 3). V_3 and V_{SS} , of which V_3 is the major component, were related to age (table 4). Neither V_1 of the four-compartment model of thiopental disposition nor V_C of either three-compartment model of the same was related to age (fig. 4 A-C).

The mean residence time (MRT, the average time a molecule of drug spends in a given compartment) of thiopental in the four compartments and the turnover time for V_1 (i.e., the reciprocal of the sum of the exiting rate constants) of the thiopental pharmacokinetic model illustrated in figure 1 are presented in table 6. None of these variables was correlated with either mass or age for the patients in the present study. The MRT (table 6) can be used as an index of the rate of equilibration of the peripheral compartments with the central compartment (V_1) as very fast (V_4), fast ($V_{2 \cdot TP}$), and slow (V_3).

TABLE 4. Relationships of Indocyanine Green and Thiopental Pharmacokinetic Variables to Age*

Variable	Slope	Intercept	r
Cl_{21}	-0.02	2.83	-0.44
$Cl_{E \cdot ICG}$	-0.005	1.24	-0.45
$V_{3 \cdot TP}$	1.06	40.20	0.54
$V_{SS \cdot TP}$	1.19	78.28	0.47

* $P < 0.05$ for all correlations between pharmacokinetic variables and age. All other such correlations failed to meet the criterion for rejection of the null hypothesis.

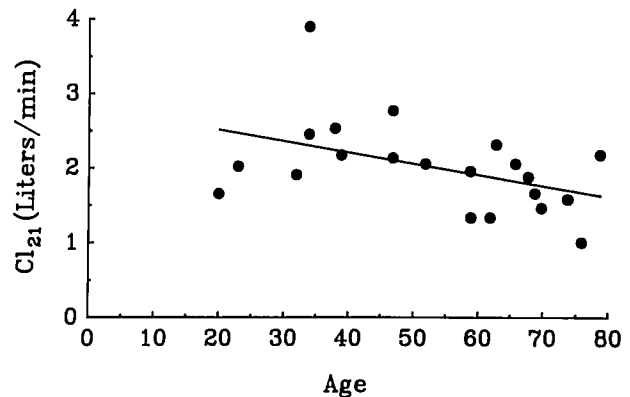

FIG. 3. The relationship of the intercompartmental clearance of ICG and thiopental from V_1 to $V_{2 \cdot ICG}$ and $V_{2 \cdot TP}$, respectively, ($Cl_{21 \cdot ICG} = Cl_{21 \cdot TP}$) to age. The line is the least-squares linear regression line fit to the data: $Cl_{21} = -0.02 \text{ age} + 2.83$, $r = -0.44$.

Discussion

Because thiopental equilibration between blood and brain is very rapid,²⁷ increased reactivity of the elderly to thiopental¹⁻⁴ may be due to pharmacokinetic changes that result in higher-than-normal initial plasma drug concentrations. An age-dependent decrease in central distribution volume would result in higher initial plasma drug concentrations, due to a lesser initial dilution of the dose. A decreased rate of drug transfer from the central volume to other rapidly equilibrating volumes could also result in prolonged high early plasma drug concentrations due to slowed drug distribution from its initial distribution volume, thus prolonging thiopental redistribution from the brain. Age-related changes in the total volume of dis-

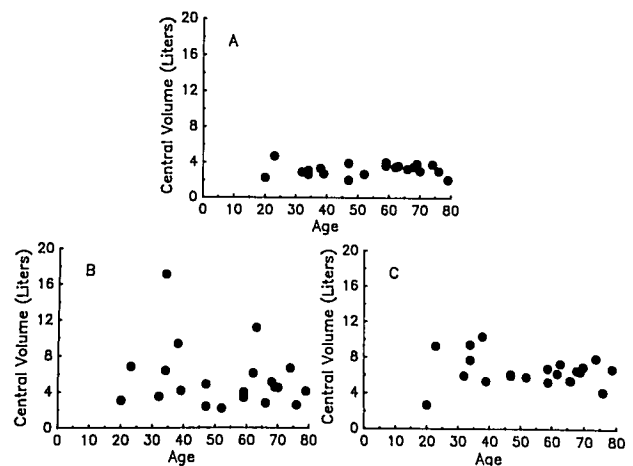

FIG. 4. The lack of relationship of the central compartment of both the four-compartment model of thiopental disposition (V_1 , A) and the three-compartment models of thiopental disposition (V_C , B based on all data and C based on data collected after the assumption of complete mixing with the central, intravascular, volume is satisfied) to age.

TABLE 5. Thiopental Four-Compartment Pharmacokinetic Variables ($\bar{x} \pm SD$)*

Age Range (yr)	Volumes (l)					Clearance (l/min)					Cl _z (ml·min ⁻¹ ·kg ⁻¹)	t _{1/2α} (h)
	V ₁ †	V ₂	V ₃ ‡	V ₄	V _{ss} ‡	Cl _h ‡	Cl ₁	Cl ₂	Cl ₃ ‡	Cl _z §		
20-45	3.1 ± 0.8	31.1 ± 10.3	66.2 ± 18.1	8.0 ± 4.5	108.4 ± 27.1	2.39 ± 0.74	0.30 ± 0.08	2.86 ± 1.83	5.55 ± 1.92	0.34 ± 0.10	3.60 ± 0.71	5.8 ± 1.8
46-65	3.4 ± 0.7	30.0 ± 12.2	108.9 ± 30.1	11.4 ± 5.7	153.7 ± 37.4	2.00 ± 0.52	0.46 ± 0.09	2.59 ± 1.66	5.05 ± 1.55	0.33 ± 0.09	3.62 ± 0.73	7.5 ± 1.8
66-80	3.2 ± 0.6	34.2 ± 21.7	113.1 ± 37.5	10.5 ± 3.8	161.1 ± 53.4	1.70 ± 0.40	0.46 ± 0.21	2.38 ± 0.86	4.54 ± 0.68	0.36 ± 0.09	4.02 ± 0.71	6.6 ± 2.2
20-80	3.2 ± 0.7	31.8 ± 14.9	96.1 ± 35.5	10.0 ± 4.7	141.1 ± 45.4	2.03 ± 0.62	0.41 ± 0.15	2.61 ± 1.45	5.05 ± 1.46	0.34 ± 0.09	3.75 ± 0.71	6.6 ± 2.0

* N = 7 in each age range except N = 21 in the 20-80-yr range.

† This variable was related to body mass and is presented in table 2 normalized by body mass.

‡ Correlated with age.

§ This variable was related to body mass.

tribution or the elimination clearance of a drug can affect its half-life but cannot explain exaggerated initial responses of the elderly to standard doses of such a drug.

Homer and Stanski have attributed decreased dose requirement in the elderly to a marked decrease in the initial distribution volume of thiopental with advancing age.⁴ Using an experimental protocol and a pharmacokinetic analysis designed to describe early drug distribution as precisely as possible,¹⁴ the present study was unable to confirm the age-related decrease in thiopental initial distribution volume reported by Homer and Stanski.⁴ Not only was there no change in thiopental central volume with age in the four-compartment model (V₁, table 5, fig. 4 A), but when the data were analyzed using three-compartment open mammillary models like that of Homer and Stanski,⁴ there was also no change in thiopental central volume with age (V_C, fig. 4 B and C). The lack of agreement between the present study and that of Homer and Stanski⁴ is a result of differences in experimental design and the difficulties inherent in describing early drug distribution accurately.⁸⁻¹⁰ In the study by Homer and Stanski,⁴ smaller estimates of the initial distribution volume would be expected in the older patients because early blood samples were obtained during the infusion from an arterial site between the site of drug administration and peripheral capillary beds.²⁸ Thus, because of the way the drug was administered to the elderly, and the site at which blood was sampled, the drug would be mixed within a smaller distribution volume in the elderly than it would be after bolus administration to the young patients with arterial blood sampling beginning 1 min after drug administration.^{8,9,28} Other investigators^{5,6} were unable to describe accurately early thiopental distribution after rapid iv administration because they failed to obtain frequent early arterial blood samples.

Like the studies of Christensen *et al.*⁵ and Jung *et al.*,⁶ the present four-compartment model of thiopental disposition described an increase in the total volume of distribution, V_{SS}, with age due primarily to an increase in the volume of the slowly equilibrating compartment (V₃, tables 4 and 5). In addition, the four-compartment model allowed description of an age-related decrease in the clearance of drug from the central to the rapidly equilibrating (fast) compartment (Cl₂₁, tables 4 and 5, fig. 3) that is similar to the results of Christensen *et al.*⁵ It is possible that the 35% decrease in this clearance between the ages of 20-80 yr accounts for the similar reported decrease in thiopental dose requirement over this age range.¹⁻⁴ Intercompartmental clearance to the slowly equilibrating compartment, Cl₃₁, has remarkably little interindividual variability (table 5). Clearance to the rapidly equilibrating compartment, Cl₄₁, has considerable interindividual variation (table 5) but there is no significant correlation of this variable with age.

The concomitant modelling of thiopental and ICG disposition allows interpretation of Cl_{21} as representing intravascular mixing between a central blood pool, V_1 , and the slowly equilibrating blood pool, V_{2-ICG} , from which thiopental distributes by diffusion to the tissues with which V_{2-ICG} is associated. Thus, intravascular mixing of thiopental and ICG is prolonged in the elderly to the same extent the dose of thiopental has been shown to be reduced.¹⁻⁴

Intercompartmental clearance is a volume-independent estimate of drug transfer between compartments that is directly determined by tissue blood flow and transcapillary permeability.²⁹ Early drug distribution can be described in terms of an expanding volume of distribution;³³ the initial rate of change in distribution volume is the sum of intercompartmental clearances ($\sum Cl_i$).²¹ Intercompartmental clearance of highly permeable substances, such as small ions,³⁰ theophylline,³¹ and alfentanil,³² may represent tissue blood flow with the sum of the intercompartmental clearances approximating cardiac output. We have suggested the same is true for thiopental.¹⁴

The apparent rapid expansion of the volume of distribution by intercompartmental clearance (*i.e.*, drug distribution) determines the extent of the dilution of the dose and, therefore, the concentrations in the effect compartment. It is possible to estimate thiopental's apparent volume of distribution at the time its maximum effect is observed (*i.e.*, when the effect compartment is in equilibrium with the decreasing concentrations in V_1).³³ For thiopental, one would expect this time to be 1–2 min.^{4,34} The volume at this time, although not determined simply by the initial rate of change in V_1 (*i.e.*, $\sum Cl_i$),^{21,33} is clearly related to both $\sum Cl_i$ and V_1 .

There is essentially no difference between the 20–45 yr age group and the 66–80 yr age group in the thiopental distribution volume *versus* time relationship until the volumes approach the final distribution volumes (fig. 5), when they are known to be different (tables 4 and 5).^{5,6} Because of the lack of difference between the two age groups in distribution volume at 1 min, we conclude that the average age-related change in Cl_{21} may not provide a sufficient pharmacokinetic rationale for decreasing the thiopental induction dose in the elderly. This is consistent with the lack of correlation of either the turnover time in V_1 or

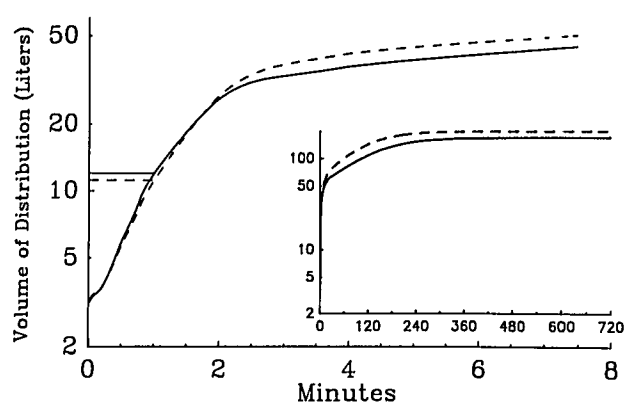

FIG. 5. Plots of the blood equivalent volume of distribution of thiopental (V) as a function of time for the time of greatest interest (first 8 min); the insert shows the relationship for the entire 12 h of data collection. V is calculated from average fitted pharmacokinetic variables at each time, t , by dividing the amount of thiopental remaining in the body at t by the concentration in V_1 at t during and following a 15 s infusion.³³ The volumes at 1 min are shown by horizontal lines connected to the ordinate for the 20–45-yr age group (solid line) and the 66–80-yr age group (broken line).

the mean residence times in any compartment with age (table 6).

Increased reactivity of the elderly to thiopental may be more apparent than real. Several investigators have found a poor correlation between induction dose requirement and body mass,^{35,36} the dose requirement being more closely related to lean body mass.³⁵ Wulfsohn and Joshi have suggested the decreased thiopental dose requirement in the elderly may be due to a decrease in lean body mass with age³⁵ although this hypothesis has not been tested.³⁷ Adjusting the thiopental dose on the basis of lean body mass may provide the rational basis for dose adjustment in the elderly because the proportion of body mass represented by lean body mass decreases with age.³⁸ The increase in V_3 (distribution to which minimally affects early plasma thiopental concentrations) and, as a result, V_{ss} of the four-compartment model with age (tables 4 and 5) is consistent with the observed age-related change in body composition.³⁸ In addition, the lack of relationship of any pharmacokinetic variable other than V_1 and Cl_E with body mass despite the wide range of masses (61–134

TABLE 6. Turnover Time in Compartment V_1 (TT 1) (min) and Mean Residence Times (MRT) (min) in Compartments 1–4 of the Four-Compartment Thiopental Pharmacokinetic Model ($\bar{x} \pm SD$)*

Age Range (yr)	TT 1	MRT 1	MRT 2	MRT 3	MRT 4
20–45	0.64 ± 0.23	10 ± 2	102 ± 54	465 ± 187	28 ± 9
46–65	0.66 ± 0.15	11 ± 3	101 ± 42	615 ± 196	48 ± 28
66–80	0.71 ± 0.08	9 ± 2	101 ± 63	664 ± 447	35 ± 14
20–80	0.67 ± 0.16	10 ± 3	101 ± 51	581 ± 299	37 ± 20

* N = 7 in each age range except N = 21 in the 20–80-yr range.

kg) in the present study (tables 3 and 5), suggests that estimating dose from total body mass is inappropriate.

How then are rational adjustments of thiopental doses to be made in the elderly? As appealing as the rationale of dosage adjustment on the basis of a decrease in V_C with age is,^{4,37} the present study clearly demonstrated such a decrease in V_C does not occur (fig. 4). The present pharmacokinetic results suggest the appropriate dose of a drug with a rapid onset of effect, such as thiopental, is determined by the intercompartmental clearances, either individually (*e.g.*, Cl_{21}) or as a sum (*i.e.*, $\sum Cl_i$), and may serve as a guide to adjusting thiopental doses. Until this relationship is evaluated prospectively, dosing adjustments may be made on the basis of the lean body mass of the patient;^{35,36} this recommendation is reasonable because cardiac output appears to predict $\sum Cl_i$ ^{14,30-32} and lean body mass is more closely related to cardiac output than is either total body mass or body surface area.³⁹ Appropriate doses of thiopental in the elderly should be selected, as they should be in any patient, on the basis of physiologic or pathophysiologic factors that may affect the pharmacokinetics or pharmacodynamics of the drug and not on the basis of age alone.⁴⁰

The authors wish to thank Colin A. Shanks, M.D. for his knowledgeable discussions, as well as Diane L. Morton for her technical assistance and Diane Lewis and Adriana Contreras for typing this manuscript.

References

- Dundee JW: The influences of body weight, sex and age on the dosage of thiopentone. *Br J Anaesth* 26:164-173, 1954
- Christensen JH, Andreasen F: Individual variation in response to thiopental. *Acta Anaesthesiol Scand* 22:303-313, 1978
- Dundee JW, Hassard TH, McGowan WAW, Henshaw J: The 'induction' dose of thiopentone: A method of study and preliminary illustrative results. *Anaesthesia* 37:1176-1184, 1982
- Homer TD, Stanski DR: The effect of increasing age on thiopental disposition and anesthetic requirement. *ANESTHESIOLOGY* 62:714-724, 1985
- Christensen JH, Andreasen F, Jansen JA: Pharmacokinetics and pharmacodynamics of thiopentone: A comparison between young and elderly patients. *Anaesthesia* 37:398-404, 1982
- Jung D, Mayersohn M, Perrier D, Calkins J, Saunders R: Thiopental disposition as a function of age in female patients undergoing surgery. *ANESTHESIOLOGY* 56:263-268, 1982
- Sheiner LB, Benet LZ, Pagliaro LA: A standard approach to compiling clinical pharmacokinetic data. *J Pharmacokinet Biopharm* 9:59-127, 1981
- Chiou WL: Potential pitfalls in the conventional pharmacokinetic studies: Effects of the initial mixing of drug in blood and the pulmonary first pass elimination. *J Pharmacokinet Biopharm* 7:527-536, 1979
- Chiou WL: Potential effect of early blood sampling schedule on calculated pharmacokinetics of drugs after intravenous administration. *J Pharm Sci* 69:867-869, 1980
- DiStefano JJ III, Landaw EM: Multiexponential, multicompartmental, and noncompartmental modeling. I. Methodological limitations and physiological interpretations. *Am J Physiol* 246:R651-R664, 1984
- Riggs DS: *The Mathematical Approach to Physiological Problems: A Critical Primer*. Cambridge, MIT Press, 1963, pp 168-220
- Fragen RJ, Avram MJ: Comparative pharmacology of drugs used for the induction of anesthesia, *Advances in Anesthesia*, Volume 3. Edited by Stoelting RK, Barash PG, Gallagher TJ. Chicago, Yearbook Medical Publishers, Inc., 1986, pp 103-132
- Lawson HC: The volume of blood—A critical examination of methods for its measurement, *Handbook of Physiology*, Section 2: Circulation, Volume 1. Edited by Hamilton WF. Washington, American Physiological Society, 1962, pp 23-49
- Henthorn TK, Avram MJ, Krejcie TC: Intravascular mixing and drug distribution: The concurrent disposition of thiopental and indocyanine green. *Clin Pharmacol Ther* 45:56-65, 1989
- Svensson CK, Edwards DJ, Lalka D, Mauriello PM, Middleton E, Jr: Comparison of chromatographic and spectrophotometric analysis of indocyanine green in plasma following administration of multiple doses to humans. *J Pharm Sci* 71:1305-1306, 1982
- Heintz R, Svensson CK, Stoeckel K, Powers GJ, Lalka D: Indocyanine green: Pharmacokinetics in the rabbit and relevant studies of its stability and purity. *J Pharm Sci* 75:398-402, 1986
- Avram MJ, Krejcie TC: Determination of sodium pentobarbital and either sodium methohexital or sodium thiopental in plasma by high performance liquid chromatography with ultraviolet detection. *J Chromatogr* 414:484-491, 1987
- Morgan DJ, Blackman GL, Paull JD, Wolf LJ: Pharmacokinetics and plasma binding of thiopental. I: Studies in surgical patients. *ANESTHESIOLOGY* 54:467-473, 1981
- Berman M, Weiss M: *SAAM Users Manual*. Bethesda, DHEW Publication (NIH), 1978
- Boston RC, Greif PC, Berman M: Conversational SAAM—An interactive program for kinetic analysis of biological systems. *Comput Programs Biomed* 13:111-119, 1981
- Avram MJ, Henthorn TK, Shanks CA, Krejcie TC: The initial rate of change in distribution volume is the sum of intercompartment clearances. *J Pharm Sci* 75:919-920, 1986
- Covell DG, Berman M, Delisi C: Mean-residence time—Theoretical development, experimental determination, and practical use in tracer analysis. *Math Biosci* 72:213-244, 1984
- Ghoneim MM, Van Hamme MJ: Pharmacokinetics of thiopentone: Effects of enflurane and nitrous oxide anaesthesia and surgery. *Br J Anaesth* 50:1237-1242, 1978
- Hudson RJ, Stanski DR, Burch PG: Pharmacokinetics of methohexital and thiopental in surgical patients. *ANESTHESIOLOGY* 59:215-219, 1983
- Glantz SA: *Primer of Biostatistics*. New York, McGraw-Hill Book Company, 1981, pp 180-228
- Metzler CM: Estimation of pharmacokinetic parameters: Statistical considerations, *International Encyclopedia of Pharmacology and Therapeutics*, Section 122, Pharmacokinetics: Theory and Methodology. Edited by Rowland M, Tucker GT. New York, Pergamon, 1986, pp 407-420
- Price HL, Kovnat PJ, Safer JN, Conner EH, Price ML: The uptake of thiopental by body tissues and its relation to the duration of narcosis. *Clin Pharmacol Ther* 1:16-22, 1960
- Atkinson AJ Jr., Henthorn TK: Thiopental anesthesia in the elderly (editorial). *ANESTHESIOLOGY* 62:706-707, 1985
- Stec GP, Atkinson AJ Jr.: Analysis of the contributions of permeability and flow to intercompartmental clearance. *J Pharmacokinet Biopharm* 9:167-180, 1981
- Charkes ND: Mathematical basis for the measurement of absolute and fractional cardiac output with diffusible tracers by compartmental analysis methods. *J Pharmacokinet Biopharm* 12:517-524, 1984
- Belknap SM, Nelson JE, Ruo TI, Fredericksen MC, Worwag EM, Shin S-G, Atkinson AJ Jr: Theophylline distribution kinetics

- analyzed by reference to simultaneously injected urea and inulin. *J Pharmacol Exp Ther* 243:963-969, 1987
32. Krejcie TC, Henthorn TK, Avram MJ: Alfentanil pharmacokinetics: Intravascular space and cardiac output (abstract). *ANESTHESIOLOGY* 69:A466, 1988
 33. Niazi S: Volume of distribution as a function of time. *J Pharm Sci* 65:452-454, 1976
 34. Stanski DR, Hudson RJ, Homer TD, Saidman LJ, Meathe L: Pharmacodynamic modeling of thiopental anesthesia. *J Pharmacokinet Biopharm* 12:223-240, 1984
 35. Wulfsohn NL, Joshi CW: Thiopentone dosage based on lean body mass. *Br J Anaesth* 41:516-521, 1969
 36. Crankshaw DP, Allt-Graham J: ED₅₀ values for thiopentone, methohexital, propanidid, and alfathesin: A clinical experiment. *Anaesth Intensive Care* 6:36-43, 1978
 37. Stanski DR, Hermans J: Integrating pharmacokinetics and dynamics: Variability in thiopental's dose requirement, pharmacokinetics, and pharmacodynamics. *Variability in Drug Therapy: Description, Estimation, and Control*. Edited by Rowland M, Sheiner LB, Steimer J-L. New York, Raven Press, 1985, pp 153-165
 38. Bruce A, Andersson M, Arvidsson B, Isaksson B: Body composition. Prediction of normal body potassium, body water, and body fat in adults on the basis of body height, body weight, and age. *Scand J Clin Lab Invest* 40:461-473, 1980
 39. Taylor HL, Brozek J, Keys A: Basal cardiac function and body composition with special reference to obesity. *J Clin Invest* 31: 976-983, 1952
 40. Williams TF: Aging or disease? *Clin Pharmacol Ther* 42:663-665, 1987
 41. Caldini P, Permutt S, Waddell JA, Riley RL: Effect of epinephrine on pressure, flow, and volume relationships in the systemic circulation of dogs. *Circ Res* 34:606-623, 1974
 42. Green JF: Determinants of systemic blood flow. *International Review of Physiology, Volume 18, Cardiovascular Physiology III*. Edited by Guyton AC, Young DB, Baltimore, University Park Press, 1979, pp 33-65
 43. Bishoff KB, Dedrick RL: Thiopental pharmacokinetics. *J Pharm Sci* 57:1346-1351, 1968
 44. Benowitz N, Forsyth RP, Melman KL, Rowland M: Lidocaine disposition kinetics in monkey and man I. Prediction by a perfusion model. *Clin Pharmacol Ther* 16:87-98, 1977

Appendix

The Two-Compartment Indocyanine Green Model

Indocyanine green (ICG) is a useful physiological marker because its early distribution is within the intravascular space and it is cleared by the liver with a high extraction ratio.¹⁴ The traditional methods of estimating blood volume and hepatic blood flow by fitting a monoexponential equation to blood ICG concentration *versus* time data ignore very early blood ICG concentrations because ICG is incompletely mixed within the intravascular space in that time. That portion of the curve contains useful information that allows us to describe an important component of intravascular mixing.

Following an intravascular mixing period of 2-6 min, a monoexponential decline in our blood ICG concentrations was observed (fig. 6 A); postequilibration data were fitted to a one-compartment model. To characterize the pre-equilibration data, a second exponential was necessary. The resulting biexponential curves (fig. 6 B) could be represented by a two-compartment model with elimination clearance from either the central compartment or the peripheral compartment. The V_{SS} of the central elimination model, 53 ± 8 ml/kg, systematically underestimated both expected blood volume and that determined by the traditional one-compartment model, 72 ± 12 ml/kg. The V_{SS} of the peripheral elimination model, 72 ± 11 ml/kg, not only accurately estimated blood volume but also correlated with the one-compartment volume. The two-compartment models gave identical values for elimination clearance, which are slight improvements over the one-compartment clearance since the one-compartment model overestimates clearance because of unaccounted drug loss during intravascular mixing. Thus, the model providing the most accurate physiologic assessment of ICG pharmacokinetics is the two-compartment model with peripheral elimination clearance; V_1 of this model appears to correspond to the central compartment and fast circuit of physiologic descriptions of the circulation by Caldini *et al.*⁴¹ and Green,⁴² while V_2 corresponds to the slower, larger circuit described by them which includes the splanchnic circulation (fig. 7).

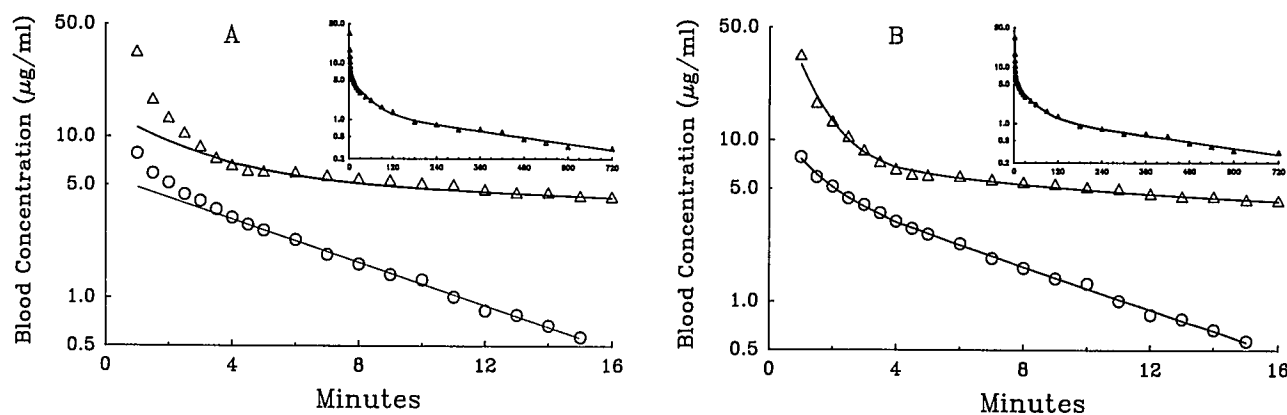

FIG. 6. Blood ICG concentration (open circles) and blood thiopental concentration (open triangles) *versus* time relationship in a representative patient. The lines are computer-derived nonlinear least-square regressions for the one-compartment ICG model and the three-compartment model (both ignoring data prior to intravascular equilibration) in panel A and for the two-compartment ICG model and the four-compartment thiopental model in panel B.

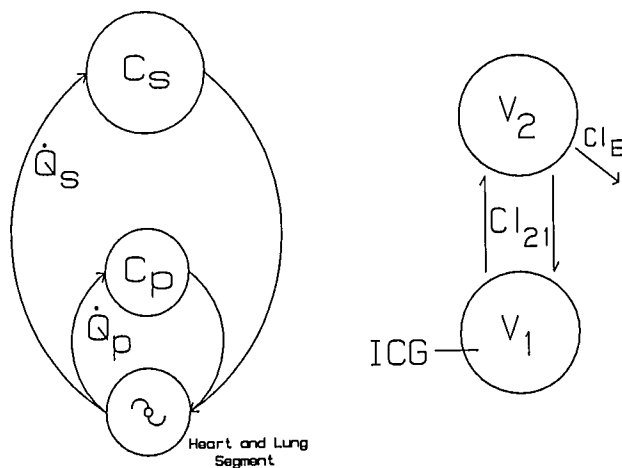

FIG. 7. On the left is a physiologic model of the intravascular space from Caldini *et al.*⁴¹ and Green.⁴² The heart and lung segment includes the great vessels and distributes blood to capacitance compartments (capillaries and venules). The larger compartment (C_S) is thought to be primarily the splanchnic circulation while the smaller compartment (C_P) represents the circulation within other peripheral tissues (*e.g.*, skeletal muscle). Transfer from the heart and lung segment to C_S and C_P is by blood flow (Q_S and Q_P , respectively). The right panel represents the kinetic model for ICG. The central compartment (V_1) of this model consists of both the heart and lung segment and C_P of the physiological model. The peripheral compartment (V_2), with hepatic elimination clearance (Cl_E), corresponds to C_S of the physiological model.

The Four-Compartment Thiopental Model

Like the one-compartment postequilibration ICG model, the three-compartment thiopental model, based on data collected after the assumption of complete mixing within the central (intravascular) compartment is satisfied,^{11,14,24} failed to describe the pre-equilibration thiopental data (fig. 6 A). To describe the pre-equilibration thiopental data, a fourth exponential analogous

to the second ICG exponential was necessary. The resulting quadriexponential curves (fig. 6 B) could be represented by a four-compartment model (fig. 1); elimination clearance of thiopental could be modelled from either V_1 or V_2 .^{TP} without affecting the model because Cl_E is significantly smaller than Cl_{21} .

The Combined Thiopental-Indocyanine Green Model

To enable physiological interpretation of the factors affecting the initial distribution of thiopental, a combined open mammillary model was used to describe the simultaneous disposition of concomitantly administered thiopental and ICG (fig. 1). The initial intravascular distribution of thiopental was assumed to be the same as that of ICG; the model variables for V_1 and Cl_{21} (fig. 1) were fitted simultaneously for both data sets and constrained to be the same. Thus, the peripheral blood volume (V_{2-ICG}), is a subset of a tissue compartment (V_{2-TP}), which is consistent with the physiologic modelling assumption that blood in a tissue is in equilibrium with the tissue.^{14,27,43,44} The elimination clearance of thiopental was assumed to occur from the tissue compartment, V_{2-TP} , associated with the obligatory site of ICG clearance, V_{2-ICG} . As reported in the first description of this combined model,¹⁴ modelling thiopental and ICG disposition simultaneously had little effect on estimates of the pharmacokinetic variables obtained by modelling them independently.

The additional (first) exponential phase described by the four-compartment combined ICG-thiopental model apparently resolves the V_C of thiopental described by three-compartment models^{4,5,14,23} into a smaller V_1 , which corresponds to a central blood volume plus a very rapidly mixing blood volume (heart and lung segment and C_P , respectively, fig. 7), and an additional, very rapidly equilibrating tissue compartment, V_4 . The sum of intercompartmental clearances, $\sum Cl_i$,²¹ of our four-compartment model is much larger than that of three-compartment models^{4,5,14} because of the additional intercompartmental clearance from our very small V_1 to the fourth compartment of this model, Cl_{41} ; the intercompartmental clearances of this model predict cardiac output and its distribution as used in physiologic models.^{14,27,44}