

A Method to Measure Elicited Contraction of Laryngeal Adductor Muscles during Anesthesia

François Donati, Ph.D., M.D., F.R.C.P.C.,* Benoît Plaud, M.D.,† Claude Meistelman, M.D.‡

The recurrent laryngeal nerve was stimulated with surface electrodes to produce vocal cord adduction, and the response was measured as pressure changes in the inflatable cuff of a tracheal tube positioned between the vocal cords. To test the linearity of the system, a model of the larynx consisting of a syringe barrel was constructed, and weights were applied to two bands of tissue simulating the vocal cords. Tests on Mallinckrodt size-7.5 tubes showed that the pressure increase produced by a given force was independent of baseline pressure in the range 10–30 mmHg. In addition, the pressure inside the inflatable cuff was linear with increasing weight (or force) for a baseline pressure of 10 mmHg. Thirty ASA physical status 1 or 2 adults were anesthetized with propofol and fentanyl. Tracheal intubation was performed in the absence of muscle relaxants, and the inflatable cuff of the tracheal tube was positioned between the vocal cords. Pressure inside the cuff was measured with an air-filled transducer. Stimulation was produced at different sites along the course of the recurrent laryngeal nerve. A surface electrode placed over the notch of the thyroid cartilage produced consistent adduction of the cords, measured as an increase of 8.9 ± 5.1 mmHg (mean \pm standard deviation [SD]) in the cuff pressure. Neuromuscular blocking drugs produced train-of-four fade, and large doses abolished the response completely, ruling out direct muscle stimulation. It is concluded that this assembly can provide useful information on intrinsic laryngeal muscle function. (Key words: Larynx, vocal cords; pressure measurements. Monitoring: neuromuscular junction; vocal cords.)

VOCAL CORD MUSCLES are important in anesthesia, because they play a role in the maintenance of a patent airway and protect the tracheobronchial tree from foreign substances. These mechanisms are affected by anesthesia and muscle relaxation. In particular, laryngeal adductor muscles are important for several reasons: adequate relaxation is required to obtain good intubating conditions; immobility of these muscles is desirable during endoscopic procedures; and airway protection depends on the return

of complete function of these muscles at the end of the anesthetic.

Stimulation of the recurrent laryngeal nerve produces contraction of the posterior cricoarytenoid muscle, which abducts the cords, and contraction of the adductor muscles.^{1,2} In animals, single-twitch stimulation of the recurrent laryngeal nerve results predominantly in abduction of the cords, as measured with a force transducer inserted in the glottic area.^{3,4}

The function of the larynx is species-dependent,² and in humans the organ has evolved to meet the requirements of erect posture and speech. Thus, the effect of recurrent nerve stimulation in humans may not be necessarily the same as in animals. Furthermore, the recurrent laryngeal nerve branches when it pierces the cricothyroid membrane, with an anterior branch supplying the adductor muscles and a posterior branch supplying the abductors.⁵ Thus, theoretically, selective stimulation of the adductors appears possible.

To study upper airway muscles, electromyography (EMG) has been used.^{6,7} Unfortunately, EMG activity is not always related to function.⁸ Acoustic reflection methods⁹ and visual inspection^{3,4} do not give information about forces involved. Pressure measurements have been performed in dogs and cats using manometers in the glottis.^{10,11} The purpose of this study was to develop a similar pressure-measuring system in humans to measure vocal cord adduction. The tracheal tube that is inserted in anesthetized patients was used, and the effect of recurrent laryngeal nerve stimulation on this system was assessed.

Materials and Methods

The protocol was approved by the Hospital Ethics Committee. Informed consent was obtained for the procedures performed in patients. This study involved three parts: simulation using a model of the larynx; stimulation of the recurrent laryngeal nerve; and measurement of response in patients. The measurement system was tested in both a laryngeal model and in patients.

MODEL OF THE LARYNX

Preliminary tests indicated that the largest increase in cuff pressure for a given force was observed in tubes with

* Associate Professor of Anaesthesia, McGill University; Visiting Professor, Institut Gustave-Roussy.

† Resident in Anesthesia, Institut Gustave-Roussy.

‡ Staff Anesthesiologist, Institut Gustave-Roussy.

Received from the Service d'anesthésie, Institut Gustave-Roussy, Villejuif, France, and the Departments of Anaesthesia, Royal Victoria Hospital and McGill University, Montreal, Québec, Canada. Accepted for publication January 3, 1991. Supported in part by the Association pour la Recherche sur le Cancer (ARC) and the Institut National de la Santé et la Recherche Médicale (INSERM).

Address reprint requests to Dr. Donati: Department of Anaesthesia, Royal Victoria Hospital, 687 Pine Avenue West, Montreal, Québec, Canada H3A 1A1.

compliant cuffs. For a given kind of tube, larger sizes had more compliant cuffs. Mallinckrodt (Athlone, Ireland) tubes were available and met the compliance criteria. A tube size of 7.5 mm ID was chosen because it was expected to fit all patients. Five such tubes from different lots were tested.

The tests consisted first of obtaining compliance curves to estimate the change in volume associated with a given change in pressure. This was done by inflating the cuff with known volumes of air. Pressure inside the cuff was measured with a Hewlett-Packard air-filled transducer normally used for invasive blood pressure measurements. The response was displayed on a video screen and recorded on paper.

Then, the same test was performed with the tube inserted into a model of the larynx. This model was constructed with the barrel of a 10-ml syringe, the piston of which had been removed. Two bands of tissue, 2 cm in width, were attached together to the inside wall of the barrel near its open end and were arranged to come out through a slit in the wall on the opposite side of the barrel (fig. 1). Both the tissue bands and the slit were parallel to the axis of the syringe barrel. The endotracheal tube was inserted so that the inflatable cuff was positioned between the bands of tissue. Compliance curves were repeated with the tube in this position. Then, known weights were attached to the bands of tissue to simulate vocal cord adduction. First, the effect of changing baseline pressure was tested. The pressure increase produced by a saline bag weighing 270 g was recorded, with the cuff previously inflated to pressures of 0, 5, 10, 15, 20, 25, and 30 mmHg. Then, the 270-g weight was removed and the linearity of the system was tested at a baseline pressure of 10 mmHg by measuring the pressure change produced by successively adding 5 bags weighing 70 g each.

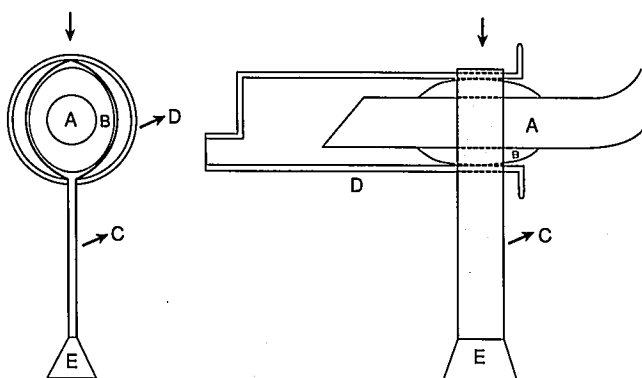

FIG. 1. Cross section (left) and side view (right) of laryngeal model. The arrow indicates the level of the section of the opposite panel. A: Tracheal tube; B: cuff; C: bands of tissue surrounding cuff; D: syringe barrel; E: weight applied to the bands of tissue. Pressure in the cuff is measured with different weights applied.

STIMULATION

Cutaneous ECG electrodes were applied along the course of the recurrent laryngeal nerve in 30 anesthetized physical status 1 or 2 adults who had received no neuromuscular relaxants. Subjects with cardiovascular, respiratory, hepatic, renal, or neuromuscular disease were excluded. Other exclusion criteria were laryngeal abnormalities, anticipated difficulty in managing the airway, or age greater than 65 yr. Anesthesia was induced with fentanyl 3–5 $\mu\text{g}/\text{kg}$ and propofol 2–4 mg/kg and was maintained with a propofol infusion at a rate of 10–20 $\text{mg} \cdot \text{kg}^{-1} \cdot \text{h}^{-1}$, with intermittent doses of fentanyl.

To determine the electrode position associated with the most reliable adduction, the negative electrode was placed on the skin in the following areas: 1) over the tracheoesophageal groove on either side, where the trachea emerges from the thorax, at the base of the neck; 2) over the cricothyroid membrane, at the posterior border of both cartilages; 3) laterally, over the cricothyroid membrane; and 4) along the midline, in many locations from the hyoid bone to the cricoid cartilage. The positive electrode was placed either on the skin overlying the sternum or on the forehead. Single-twitch stimulation, 0.2 ms in duration, was applied every 10 s with a Curametre (Bioindustry, Boulogne-sur-Mer, France) stimulator. The response was first assessed visually during direct laryngoscopy before tracheal intubation, and then by pressure measurement from the cuff of the tracheal tube. The best site of stimulation was defined as that which was associated with adduction in most, if not all, cases, and which required the lowest supramaximal stimulation.

Train-of-four stimulation (2 Hz for 2 s) was applied at intervals of 10 s or greater in patients who had not received muscle relaxants, and the current applied was varied to determine the level of supramaximal stimulation. Large doses of neuromuscular blockers (succinylcholine 0.5–1 mg/kg or vecuronium in incremental doses) were given. If the response was abolished, and/or if the fourth response in the train-of-four was absent while the first response was present, it was assumed that no direct muscle stimulation was present. These tests required 10–60 min before administration of the relaxant and were continued until recovery from the relaxant was complete and stable.

MEASUREMENT OF RESPONSE

The response was measured with a size-7.5 Mallinckrodt endotracheal tube, which was positioned, under direct vision, in such a way that the cords were in the mid-portion of the inflatable cuff. This direct laryngoscopy was performed without neuromuscular blocking drugs. No local anesthetic drug was given intratracheally. The connector designed to fit a syringe to inflate the cuff was connected to an air-filled Hewlett-Packard transducer, the

response of which was displayed on a video screen and recorded on paper. A volume of air sufficient to prevent leaks and to produce a pressure of at least 10 mmHg was injected into the cuff. Then, mechanical ventilation with 100% oxygen was instituted. Nitrous oxide and volatile agents were avoided.

The response was measured with the stimulation electrodes placed at the various sites described above. The current for supramaximal stimulation was determined and read on the display of the stimulator. Train-of-four stimulation (2 Hz for 2 s) was applied at intervals of greater than 10 s. The sizes of the first response and of the train-of-four ratio (the fourth response divided by the first) were measured in the absence of neuromuscular blocking drugs. In most patients, the endotracheal tube was moved slightly up and down the trachea to test whether the position adopted initially was optimal. Numerical results are presented as means \pm standard deviations (SD).

Results

MODEL OF THE LARYNX

The compliance of the tube cuffs decreased with increasing volume both without and with the model of the larynx (fig. 2). However, the presence of the laryngeal model decreased compliance markedly. For example, to reach a pressure of 40 mmHg, 10–12 ml were required, but this volume was reduced to only 2–2.5 ml with the addition of a laryngeal model. When a 270-g weight was applied to tissue bands of the laryngeal model, the ob-

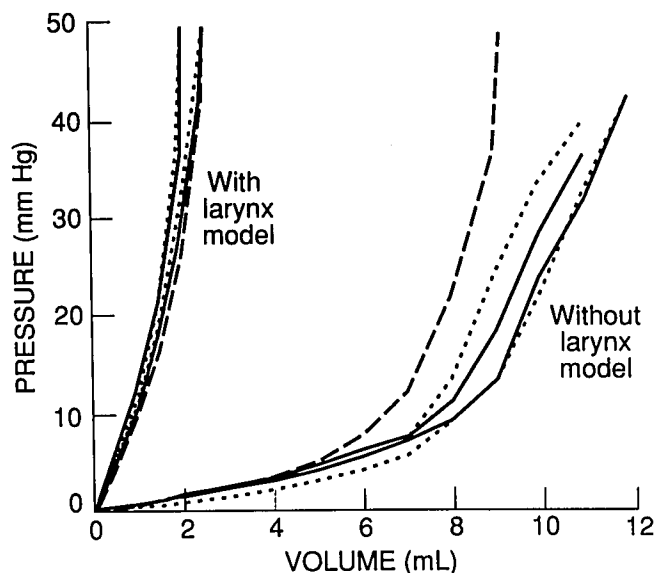

FIG. 2. Cuff compliance: pressure versus volume of air in the cuff of five Mallinckrodt 7.5-mm tubes with and without larynx model. Compliance is reduced markedly with larynx model. Each line represents one tube.

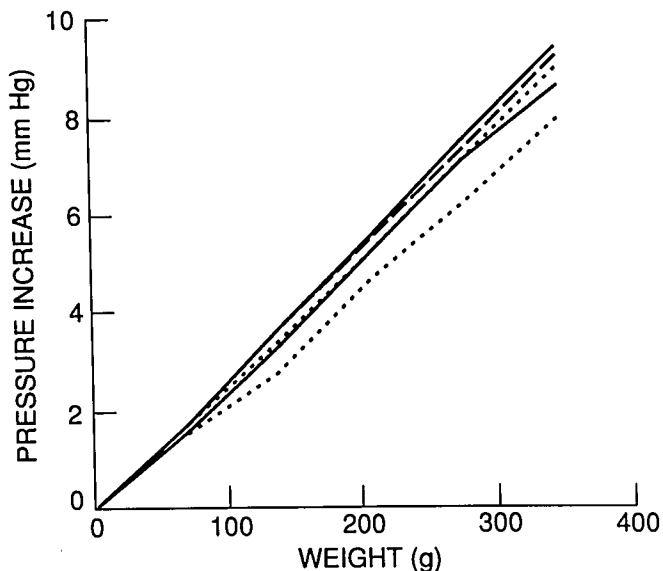

FIG. 3. Relationship between pressure change and weight applied for five Mallinckrodt 7.5-mm tubes in larynx model, for a baseline pressure of 10 mmHg. Each line represents one tube.

served pressure change increased with baseline pressure in the 0–10 mmHg range. For larger baseline pressures (10–30 mmHg), the pressure increase due to a 270-g weight was 6.5 ± 0.2 mmHg and was independent of baseline pressure. For a baseline pressure of 10 mmHg, the change in pressure was linearly related to the weight applied (fig. 3).

STIMULATION IN PATIENTS

Under direct vision, stimulation of the recurrent laryngeal nerve at the base of the neck produced abduction of the vocal cords. Stimulation with the electrode in a lateral position near the cricothyroid membrane produced, inconsistently, either abduction or adduction. Stimulation in the midline, over the space between the hyoid bone and the cricothyroid membrane, produced bilateral vocal cord adduction. The best site of stimulation, *i.e.*, the site that required the minimum current for supramaximal stimulation, was the notch of the thyroid cartilage.

RECORDINGS IN PATIENTS

With stimulation at the notch of the thyroid cartilage, increases in pressure were recorded from the cuffs that had been positioned between the vocal cords. Stimulation at other sites, and particularly at the base of the neck, produced, inconsistently, either increases or decreases in pressure (fig. 4). In women, maximal response was obtained when the tracheal tube was inserted so that the 16- or 17-cm mark was at the level of the mouth. At this level,

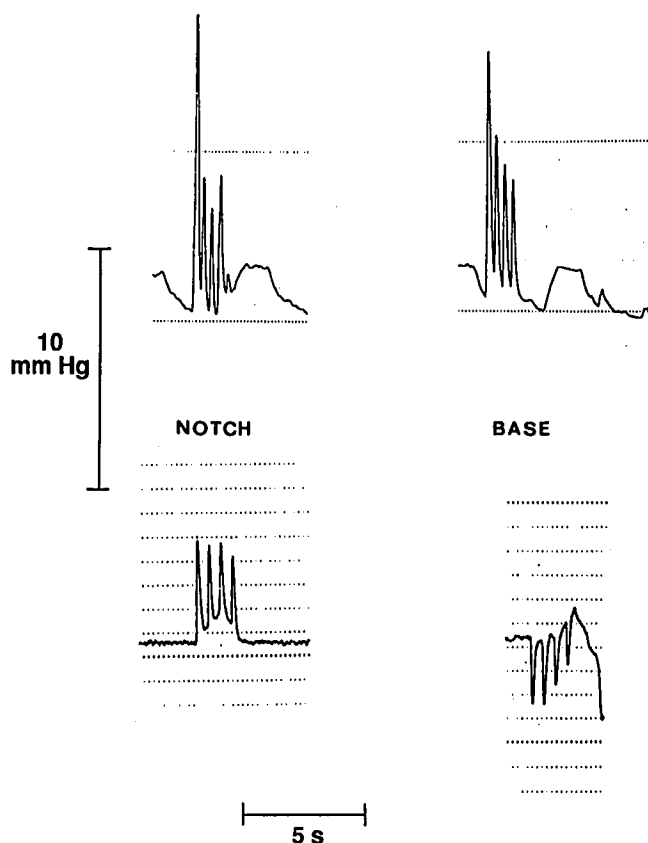

FIG. 4. Response to train-of-four stimulation with stimulation at the notch of the thyroid cartilage (*notch*), and at the base of the neck (*base*) in two patients. The response of stimulation at the notch was an increase in pressure. Stimulating at the base of the neck produced either an increase or decrease in pressure.

usually only 1–2 ml of air, corresponding to a cuff pressure of 10–12 mmHg, was required in the cuff to prevent leaks. Vocal cord adductor response decreased when the tube was more deeply inserted, and occasionally, the response to stimulation when the cuff was in the trachea was a decrease, instead of an increase, in pressure (fig. 5). When the tip of the tube was inserted less than 16–17 cm, leaks were frequent. Only three men were studied, because most of the patients in our institution who were eligible for the study were women. The same tube size (7.5 mm) was used in men, and stimulation was successful in all cases.

A change in baseline pressure in phase with the respiratory cycle was observed (figs. 6 and 7). With stimulation at the notch of the thyroid cartilage and the tube positioned optimally, the first response to supramaximal train-of-four stimulation was 8.9 ± 5.1 mmHg (mean \pm SD). In the absence of neuromuscular blocking drugs, the train-of-four ratio was less than 100% ($76 \pm 14\%$). Supramaximal stimulation was obtained with a current of 64 ± 8 mA (fig. 6). When given in sufficient doses, either succi-

nylcholine or vecuronium abolished the response completely (fig. 7). Vecuronium accentuated the train-of-four fade, and the fourth response disappeared before the first response did.

Responses obtained in patients before the administration of muscle relaxants were stable over time for up to 60 min, provided that the level of anesthesia was deep enough to prevent spontaneous movements. After administration of either succinylcholine or vecuronium, patients recovered to the same preresaxant response. When anesthesia was too light, a large increase in cuff pressure, sometimes exceeding 100 mmHg (the upper limit of sensitivity of the measuring system), was observed.

Discussion

This study demonstrated that the function of intrinsic laryngeal muscles can be studied with a system involving only the insertion of a tracheal tube. The investigation showed that measurement of the effect of adductor muscles could be obtained systematically by stimulation at the notch of the thyroid cartilage and by measurement of the pressure change in the cuff of a tracheal tube positioned between the vocal cords (in women, usually 16–17 cm

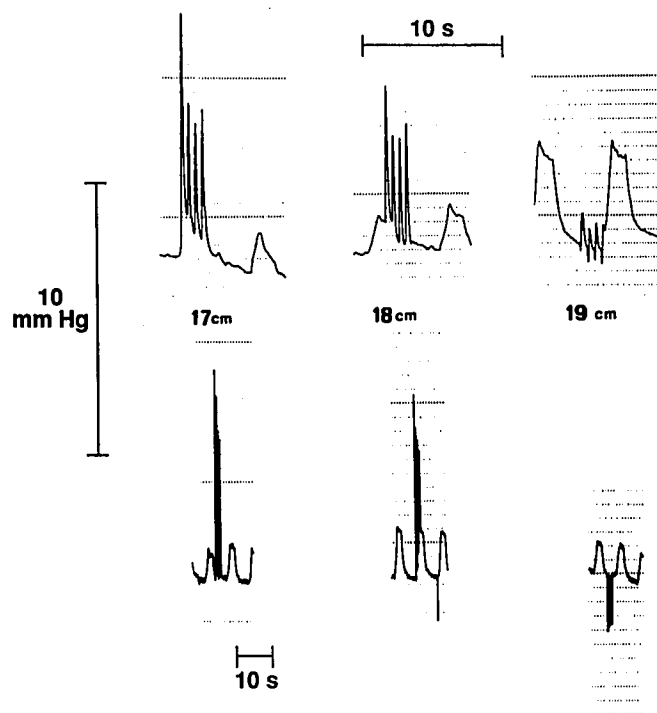
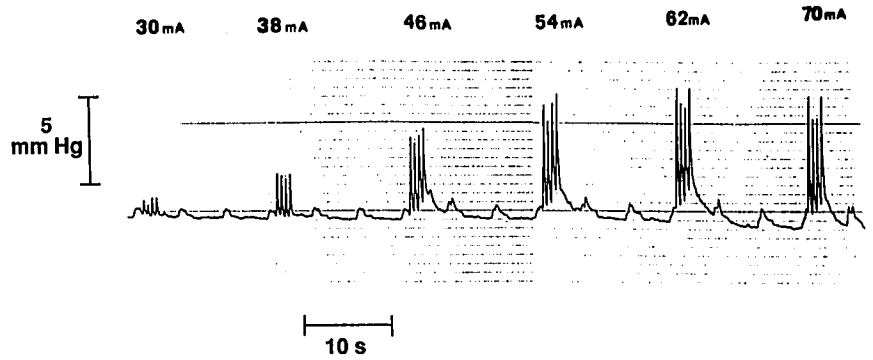

FIG. 5. Effect of varying the position of the tracheal tube on response to train-of-four stimulation at the notch of the thyroid cartilage. The numbers indicate the depth of the tracheal tube at the lip. Response decreases as depth increases. When the tube was at 19 cm, decreases in pressure were sometimes seen (*bottom right*). Time scale is five times as fast on the top tracings.

FIG. 6. Effect of increasing stimulation current at the notch of the thyroid cartilage. Response increased until a plateau was reached. In this case, supramaximal stimulation required approximately 54 mA.



from the mouth). The main advantage of the recording system is that it requires procedures no more invasive than those normally performed during general anesthesia. Although compliance curves (fig. 2) show that the pressure-volume relationship does not become linear for pressures of less than 20 mmHg, the linearity of the system when weights are applied (fig. 3) is very satisfactory in the range of 10–20 mmHg.

There are minor variations in the names anatomists give to some intrinsic laryngeal muscles. There is agreement regarding the cricothyroid, posterior cricothyroid, and lateral cricoarytenoid muscles. However, the other muscles, numbering two¹² or three,¹³ depending on the source, receive different names. For example, some describe two other muscles, the thyroarytenoid and the arytenoid.¹² The former, which is the main adductor muscle responsible for glottic closure, is divided into a medial part, the vocalis, and a lateral part, the ventricularis. Some fibers of the latter project upward and backwards to the epiglottis, and form the thyroepiglottic muscle.¹² The arytenoid is divided into transverse and oblique parts. Some fibers of the latter project anteriorly and laterally to the epiglottis, forming the aryepiglotticus muscle.¹² Other anatomists describe the transverse arytenoid and oblique arytenoid as two separate muscles,¹³ whereas some others list the aryepiglottic muscle separately.⁵ Despite the name

variations, the same function is described. Among the adductor muscles, *i.e.*, all muscles except the cricothyroid and the posterior cricoarytenoid, it appears that the most powerful is the thyroarytenoid and especially its vocalis (medial) part.¹²

In animals, stimulation of the recurrent laryngeal nerve at the base of the neck normally produces vocal cord abduction.^{3,4} A possible reason for this is that the twitch response of the abductor muscle, the posterior cricoarytenoid muscle, is longer in duration than that of the adductor muscles.⁴ Thus, the algebraic sum of the responses is abduction. Observation of vocal cord movement in the current study suggested that the same applies to humans. However, this response was not seen consistently with the measurements of pressure from inside the endotracheal tube cuff. This is probably because, at least in humans, the posterior cricoarytenoid muscle is not in the same plane as the adductor muscles, and this arrangement is difficult to appreciate visually. Anatomically, the posterior cricoarytenoid muscle is more rostral than all of the adductor muscles,¹⁴ and it is possible that when the cords open, they also move down, whereas when they close they move up. This would explain why the abductor response is recorded more easily with a tube positioned deep in the trachea (fig. 5) and why the best adductor response is recorded more cranially. An adequate investigation of

FIG. 7. Effect of a paralyzing dose of succinylcholine. Downward arrow: A dose of 0.5 mg/kg is given. Upward arrow: The response of the larynx is abolished completely.

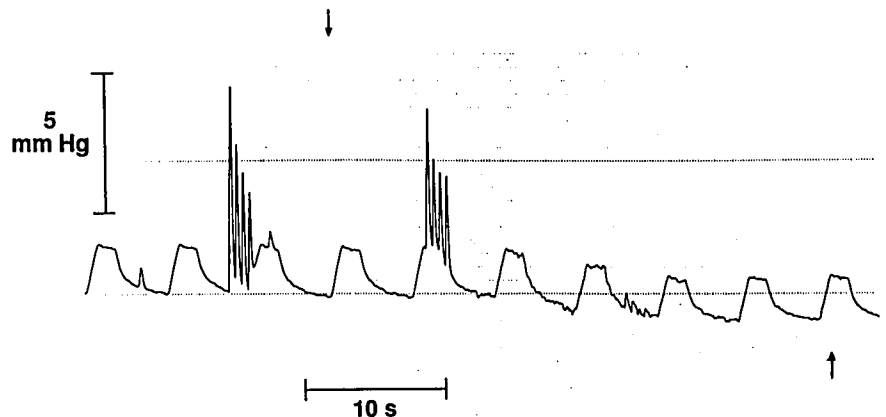

abductor muscles might be possible with appropriate placement of the measuring system, but this was not evaluated in the current study.

Stimulation at the notch of the thyroid cartilage probably caused a selective stimulation of adductor muscles (the most important of which is the thyroarytenoid) because the branches supplying these muscles project anteriorly.⁵ A negative electrode was more effective, as has been observed previously for the ulnar nerve.^{15,16} The decrease in pressure observed when the tube was positioned deep into the trachea (fig. 5) may not be the result of abductor muscle stimulation, but rather may be the effect of adductor muscles moving cranially, thus applying less pressure on a cuff positioned deeply. Thus, the response to recurrent laryngeal nerve stimulation at the base of the neck might depend not only on the relative strength of abductor *versus* the adductor muscles but also on the position of the measuring system. Adduction would be predominant with the pressure measurement system positioned more cranially, and abduction would be observed if this is moved caudally.

An air-filled transducer system was chosen for two reasons. In initial tests of fluid-filled systems, the response was overdamped, probably because of the difficulty of removing all air bubbles. In addition, a cuff filled with air appeared safer for the patient. The tests on the laryngeal model indicated that linearity in the 10–20-mmHg range was adequate. At this level of pressure in the system, damage to the vocal cords and surrounding structures appeared unlikely. Nitrous oxide was avoided because its diffusion into the cuff could alter the pressure. However, it is likely that nitrous oxide could be used, provided that periodic adjustment of baseline pressure is made. Total intravenous anesthesia was used because the system was intended for the study of muscle relaxants, and we preferred to avoid the interaction with inhalational agents. However, the system could be used with inhalational agents. That pressure changes can be observed with light anesthesia indicates that the assembly could be used to determine the depth of anesthesia. Further studies would be required to test this hypothesis.

The model chosen for the larynx appears appropriate because the volume of air required to inflate the cuff to 10–15 mmHg is similar to that used in patients (1–2 ml). The magnitude of the response obtained after nerve stimulation suggested that the vocal cord adductors are strong muscles. A pressure change of 10 mmHg was normally obtained with single-twitch stimulation, and this corresponded to the application of approximately 400 g in the model of the larynx. Larger pressures have been reported in the glottis, but these have been produced by sustained maneuvers, *i.e.*, tetanic stimulation.² The reason for train-of-four fade in the absence of neuromuscular

blockers is unknown. Reflex responses of these richly innervated structures may play a role. Nevertheless, it follows that, even without neuromuscular blockers, sufficient time (in this study, 10 s) must be allowed between stimulations.

It is concluded that important information on laryngeal muscle function can be obtained in humans, using non-invasive stimulation of the recurrent laryngeal nerve and a measuring system that is no more invasive than are the procedures normally performed during a general anesthetic. The assembly was designed for the study of neuromuscular blocking drugs on intrinsic adductor laryngeal muscles, but its use could conceivably be extended to other applications.

References

1. Van Lunteren E, Strohl KP: The muscles of the upper airways. *Clin Chest Med* 7:171–188, 1986
2. Bartlett D: Respiratory functions of the larynx. *Physiol Rev* 69: 33–57; 1989.
3. Sanders I, Aviv J, Biller HF: Transcutaneous electrical stimulation of the recurrent laryngeal nerve: A method of controlling vocal cord position. *Otolaryngol Head Neck Surg* 95:152–157, 1986.
4. Sanders I, Aviv J, Kraus WM, Racenstein MM, Biller HF: Transcutaneous electrical stimulation of the recurrent laryngeal nerve in monkeys. *Ann Otol Rhinol Laryngol* 96:38–42, 1987.
5. Gray H: *Anatomy of The Human Body*. 29th American edition. Edited by Gross CM. Philadelphia, Lea & Febiger, 1973, p 1131.
6. Guindi GM, Payne JK, Higenbottam TW: Clinical electromyography in ear, nose and throat practice. *J Laryngol Otol* 95:407–413, 1981.
7. Berry H, Blair RL, Briant TDR: A method of percutaneous laryngeal electromyography. *J Otolaryngol* 6:491–495, 1977.
8. Drummond GB: Influence of thiopentone on upper airway muscles. *Br J Anaesth* 63:12–21, 1989.
9. D'Urzo AD, Rubinstein I, Lawson VG, Vassal KP, Rebeck AS, Slutsky AS, Hoffstein V: Comparison of glottic areas measured by acoustic reflection vs. computerized tomography. *J Appl Physiol* 64:367–370, 1988.
10. Murakami Y, Kirshner JA: Mechanical and physiological properties of reflex laryngeal closure. *Ann Otol Rhinol Laryngol* 81:59–71, 1972.
11. Suzuki M, Sasaki CT: Laryngeal spasm: A neurophysiologic definition. *Ann Otol Rhinol Laryngol* 86:150–157, 1977.
12. Gray H: *Anatomy of the Human Body*. 30th American edition. Edited by Clemente CD. Philadelphia, Lea & Febiger, 1985, pp 1374–1376.
13. Woodburne RT: *Essentials of Human Anatomy*. 7th edition. New York, Oxford University Press, 1983, pp 187–190.
14. Lipton RJ, McCaffrey TV, Cahill DR: Sectional anatomy of the larynx: Implications for the transcutaneous approach to endolaryngeal structures. *Ann Otol Rhinol Laryngol* 98:141–144, 1989.
15. Rosenberg H, Greenhow DE: Peripheral nerve stimulator performance: The influence of output polarity and electrode placement. *Can Anaesth Soc J* 25:424–426, 1978.
16. Berger JJ, Gravenstein JS, Munsen ES. Electrode polarity and peripheral nerve stimulation. *ANESTHESIOLOGY* 56:402–404, 1982