

A Comparison in a Lung Model of Low- and High-flow Regulators for Transtracheal Jet Ventilation

Sheila D. Gaughan, M.D.,* George T. Ozaki,† Jonathan L. Benumof, M.D.‡

There is widespread agreement that transtracheal jet ventilation (TTJV) using a percutaneously inserted intravenous (iv) catheter through the cricothyroid membrane is a simple, quick, relatively safe, and extremely effective treatment for the situation in which neither ventilation nor intubation can be achieved. No study has reported whether a low-flow pressure-reducing regulator (LFR) can provide enough driving pressure and flow under a variety of clinical circumstances for adequate TTJV. We determined, using a high-flow regulator (HFR) as our control, the tidal volume (V_T) (measured by integrating a pneumotachograph signal) that a LFR could deliver via a Carden jet injector through 14- and 20-G iv catheters initially at an inspiratory:expiratory ratio (I:E) = 1:1 (unit of time = 1 s) in a mechanical model that had varying lung compliance (C_{set} , 10–100 ml/cmH₂O) and airway diameters (proximal trachea 15.0, 4.5, or 3.0 mm ID and distal mainstem bronchi 9.0 or 4.5 mm ID). The lowest C_{set} (10 ml/cmH₂O) and smallest airway diameter (tracheal diameter = 3.0 mm, bronchial diameter = 9.0 mm) resulted in the lowest V_T (220 and 320 ml for the 20- and 14-G iv catheters, respectively, with the LFR), and the highest C_{set} (100 ml/cmH₂O) and largest airway diameter (tracheal diameter = 15 mm, bronchial diameter = 9.0 mm) resulted in the highest V_T (780 and 1040 ml for the 20- and 14-G iv catheters, respectively, with the LFR). The V_T produced during TTJV was greatly dependent on air entrainment (measured by a second pneumotachograph), with the contribution to total V_T ranging from 15 to 74%; the amount of air entrainment was independently confirmed by excellent agreement between measured and calculated alveolar oxygen concentrations. Decreasing C_{set} (with the largest airway diameter) and decreasing airway diameter (at C_{set} = 50 ml/cmH₂O) over the full range studied resulted in approximately a 45–80% decrease in V_T for all iv catheter/regulator combinations. Increasing C_{set} and narrowing airway diameter over the full range studied resulted in a progressive increase in end-expiratory volume (EEV) for all iv catheter/regulator combinations. The I:E ratio was also varied from 1:3 to 3:1 (unit of time = 1 s) using the 14-G catheter at C_{set} = 50 ml/cmH₂O with both regulators at the extremes of the proximal tracheal diameters (15.0 and 3.0 mm ID), and we found that jet ventilation through a proximal tracheal diameter of 3.0 mm with the HFR at I:E ratios = 1:1 and 3:1, EEV exceeded the capacity of the mechanical lung (4,000 ml). The greatest minute ventilations were obtained at an I:E ratio = 1:1 for both the HFR and LFR with peak values of 54.0 and 27.6 l/min, respectively. To gain the most benefit (the highest minute ventilation)

and to avoid the most risk from jet ventilation (dynamic hyperventilation, excessive increases in EEV), the recommended I:E ratios are 1:1 for the LFR and 1:3 for the HFR. At these I:E ratios, substantial, if not total, ventilatory support can be provided over a wide range of clinical situations with TTJV by both regulators. (Key words: Equipment: high-flow regulator; low-flow regulator, oxygen tank. Ventilation: tidal volume; transtracheal jet. Lung: airway resistance; compliance. Resuscitation.)

IT HAS BEEN ESTIMATED that inability to provide a life-sustaining amount of gas exchange in a situation in which neither ventilation by mask nor intubation can be achieved has been responsible for up to 30% of deaths totally attributable to anesthesia.^{1,2} There is widespread agreement that transtracheal jet ventilation (TTJV) using a percutaneously inserted intravenous (iv) catheter through the cricothyroid membrane is a simple, very quick, relatively safe, and extremely effective treatment for the cannot-ventilate/cannot-intubate situation. In order to achieve adequate ventilation and oxygenation, the TTJV system must have a high-pressure oxygen source (approximately 50 psi) that drives oxygen through noncompliant tubing and a relatively small iv catheter.

Tank regulators can be classified as high-flow or low-flow with respect to the steady-state pressure (pounds per square inch) and corresponding flow rates that each can generate. A high-flow tank regulator (HFR) can achieve maximum steady-state pressures of 100 psi and flow rates of 320 l/min and therefore presents no problem with respect to providing adequate TTJV. A LFR (such as those that are commonly available on small [E cylinder] oxygen transport tanks) can achieve a maximum pressure of 120 psi (when the flow meter is set at the maximum of 15 l/min, but no flow is allowed to occur), but once flow commences, the pressure in the regulator rapidly decreases to steady-state values of 0–5 psi that permits the steady-state flow that was preset on the flow meter (0–15 l/min).

No study has reported whether a LFR can provide enough driving pressure and flow under a variety of clinical circumstances for adequate TTJV. This mechanical lung model study determined, using a HFR set at 50 psi as the control, the jet ventilation tidal volume (V_T) and resultant end-expiratory lung volume (EEV) a LFR could deliver using 14- and 20-G iv catheters as a function of a widely varying lung compliance and airway resistance at

* Resident in Anesthesiology.

† Specialist in Anesthesia.

‡ Professor of Anesthesia.

Received from the University of California at San Diego Medical Center, Department of Anesthesiology. Accepted for publication March 9, 1992.

Address reprint requests to Dr. Benumof: UCSD Medical Center, Mail Code 8812, 225 Dickinson Street, San Diego, California 92103-8812.

several different inspiratory:expiratory (I:E) ratios. From this data, the effectiveness of TTJV using a LFR during commonly encountered clinical situations can be established.

Materials and Methods

EXPERIMENTAL MODEL

Our experimental model (fig. 1) consisted of a jet ventilation apparatus and a mechanical lung. The jet ventilation apparatus consisted of a standard E cylinder oxygen tank fitted with either an HFR (0–320 l/min) (Matheson Reducing Pressure Regulator, model 1L-540, East Rutherford, NJ) or a low-flow (0–15 l/min) regulator (Chemtron Oxygen Regulator, Series 2000, St. Louis, MO). For both the HFR and LFR, the pressure setting was independently measured with a calibrated manometer (Perma-Cal, Advanced Technology, Monrovia, CA). The tank regulator was connected to a jet injector (Bivona Inc., Carden Jetting Device, Model Carget, Gary, IN). The I:E ratio of the jet injector was precisely varied using a solenoid mechanical thumb (type 18P, Guardian Electric Company, Chicago, IL) that was electronically driven

(model 88F, Grass Instruments, Quincy, MA). The jet injector was connected by polyvinylchloride tubing to a plastic iv test catheter (14- and 20-G, each 2 inches long, Abbocath T series, Abbott Hospital, Chicago, IL). The test iv catheter was inserted into the trachea of a mechanical lung.

The mechanical lung consisted of two inflatable bellows (alveolar space, each 2 l) connected to a conducting airway (upper airway, trachea, mainstem bronchi). The test iv catheter entered the conducting airway near the proximal end of the trachea (12 cm long, 19 mm ID, silicone tubing) through a 15-mm male-to-female sampling elbow; the iv jet ventilating catheter was cemented into the sampling port so that there were no leaks and the test catheter projected into the center of the female outlet of the elbow and was nonmovable (minimal catheter tip whip with jet ventilation). The male end of the elbow was joined to the upper airway by either a 15-mm connector or by a 4.5- or 3.0-mm endotracheal tube adapter (representing an increase in proximal tracheal resistance at a single point). The upper airway consisted of 14-cm, 22-mm-ID corrugated plastic tubing. The proximal end of the upper airway was connected to a pneumotachograph (Fleisch, model 2, New York, NY).

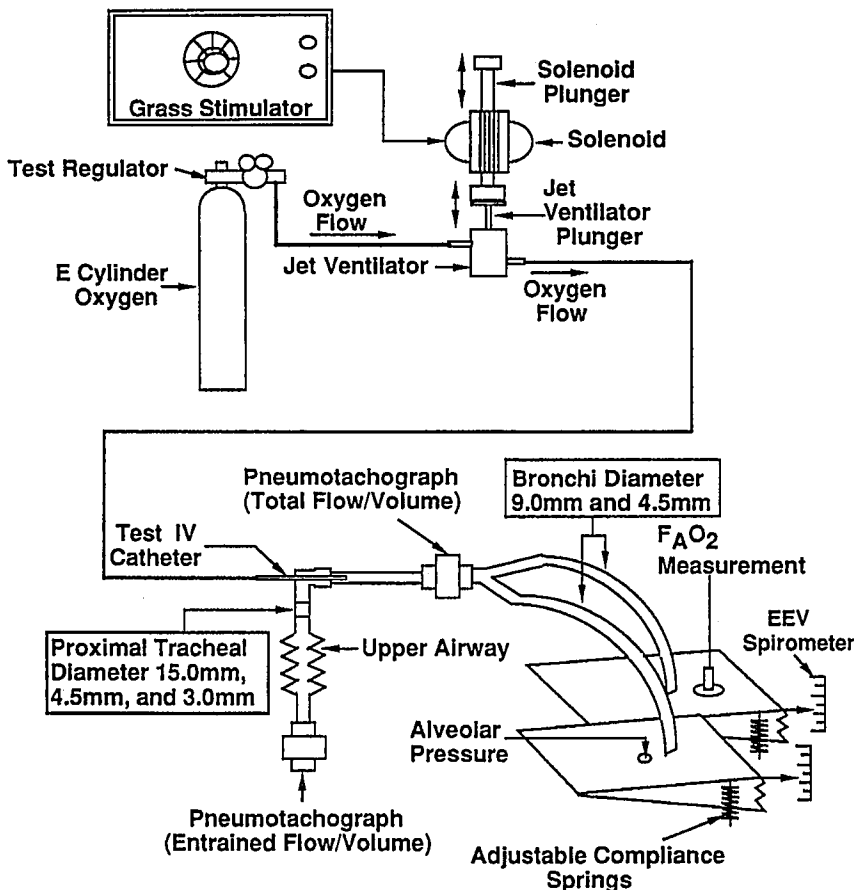

FIG. 1. The experimental model. The model consisted of a ventilatory apparatus (oxygen tank, test regulator, jet ventilator, and test intravenous catheter) and a mechanical lung model. The mechanical lung model consisted of a conducting airway (upper airway, trachea, mainstem bronchi) and two inflatable bellows (alveolar space). The test intravenous catheters were inserted through and cemented into the sampling port of a male/female elbow so that the intravenous catheter projected into the center of the female outlet and had minimal movement during jet ventilation. Two flows were measured by Fleisch pneumotachographs: the total flow at the junction of bronchi and the trachea and the entrained flow at the distal end of the upper airway. See text for full explanation. EEV = end-expiratory volume.

The distal trachea was connected to a pneumotachograph (Fleisch, model 2) which in turn was connected to the mainstem bronchi (20-cm, 9.0-mm-ID polyvinylchloride tubing) *via* a Y-connector. The bronchial airway diameter was altered by substituting 4.5-mm-ID \times 20-cm bronchi of polyvinylchloride tubing. The mainstem bronchi were connected to two inflatable bellows (Vent Aid Training Test Lung, Michigan Instrument Inc., Grand Rapids, MI) *via* 15-mm female-to-female adapters. The compliance of the inflatable bellows (C_{set}) could be varied from 100 to 10 ml/cmH₂O by adjusting a spring-loaded screw.

Two different flows were measured with the two pneumotachographs. The pneumotachograph positioned at the junction of the mainstem bronchi and trachea measured total flow entering the bellows, and the pneumotachograph positioned at the proximal end of the upper airway measured entrained air flow. The pressure across the pneumotachograph positioned between the mainstem bronchi and the trachea was measured by a differential pressure transducer (model 270, Hewlett-Packard, Waltham, MA) and the flow signal from the transducer was electronically amplified (model 8805A, Hewlett-Packard), integrated (to yield V_T) (model 8815A, Hewlett-Packard), and displayed on a permanent four-channel thermal strip-chart recorder as flow (\dot{V}) 0–250 l/min and as V_T on a 0–2-l resettable full scale (automatically resets to zero when $V_T = 2$ l) (model 7754A, Hewlett-Packard). The \dot{V} from the pneumotachograph positioned at the proximal end of the upper airway was displayed on the thermal strip-chart recorder on a 0–150-l/min fully resettable scale (automatically resets to zero when $\dot{V} = 150$ l/min). The entrained volume was measured using an Ohmeda 5400 volume monitor (Englewood, Colorado). The Ohmeda volume was within 2% of the planimeted volume obtained from a large (approximately 50%) random sample of entrained flow curves. Both pneumotachographs were calibrated using a standard 0–150-l/min oxygen flow meter (tube FP-1-27-G, Fischer and Porter Company, Warminster, PA).

The pressure in the lung (bellows) was measured with an 0–80-cmH₂O aneroid manometer (P/N 145R, Bird Products, Inc., Palm Springs, CA) connected to the external pressure port of the mechanical lung and was used to confirm on-line that $C_{set} = EEV/\text{end-expiratory pressure}$. EEV was read off the inflatable bellows spirometer. An oxygen electrode was inserted into one of the bellows to measure the alveolar oxygen concentration (FA_{O_2}) (Dräger oxygen monitor, model 04026-03, Teleford, PA).

EXPERIMENTAL SEQUENCE

The LFR was set at 120 psi by turning the flow meter to 15 l/min but not allowing any flow to occur. The con-

trol HFR was set at 50 psi, a pressure setting equivalent to central wall pressure.

The C_{set} of the mechanical lung was set at 10, 30, 50, and 100 ml/cmH₂O. The resistance to flow was altered by varying bronchial and tracheal diameters: A) reference (normal) lung:tracheal diameter = 15 mm, bronchial diameter = 9.0 mm; B) tracheal diameter = 15 mm, bronchial diameter = 4.5 mm; C) proximal (to the entry of the test iv catheter) tracheal diameter = 4.5 mm, bronchial diameter = 9.0 mm; and D) proximal tracheal diameter = 3.0 mm, bronchial diameter = 9.0 mm. We measured total and entrained \dot{V} and V_T , FA_{O_2} , and EEV for every possible permutation of regulator ($n = 2$), iv catheter ($n = 2$), C_{set} ($n = 4$), and airway diameter ($n = 4$) at I:E = 1 s:1 s (total $n = 64$). To determine the effect that varying the I:E ratio had on V_T and EEV, I:E ratios of 1:1, 1:3, and 3:1 (unit of time = 1 s) were tested with the 14-G catheter connected to both regulators at a $C_{set} = 50$ ml/cmH₂O for the extremes of proximal tracheal diameter (airways A and D, additional $n = 12$).

DATA ANALYSIS

The flow profile for both the HFR and LFR consisted of a peak followed by a rapid decay. Over the first several breaths, the peak flow and V_T progressively decreased (figs. 2 and 3) and then remained constant (steady state).

Based on the entrained air and total V_T , a theoretical FA_{O_2} could be calculated:

$$FA_{O_2} = \frac{(V_T - \text{entrained air volume})(1.0) + (\text{entrained air volume})(0.21)}{V_T}$$

We compared the calculated with the measured FA_{O_2} by linear regression analysis. For both the HFR and LFR, the data is presented for the 14- and 20-G iv catheters as C_{set} *versus* V_T , airway diameter *versus* V_T , C_{set} *versus* EEV, and airway diameter *versus* EEV and for the 14-G iv catheter as I:E ratio *versus* V_T and EEV. Both C_{set} data and airway diameter data are presented as discontinuous functions. The minute ventilations (\dot{V}_E) for each experimental situation are displayed in table format.

Results

Typical flow profiles for the HFR and LFR are presented for the 14- and 20-G iv catheters at a C_{set} of 50 ml/cmH₂O in figures 2 and 3, respectively. For each figure, panel 1 represents the entrained air flow. A deflection below the zero line corresponds to flow entrained into the upper airway, and deflections above the zero line represent flow out of the upper airway. Changing from a negative to positive slope below the zero line or from a positive to negative slope above the zero line corresponds to deceleration of flow into or out of the lungs, respec-

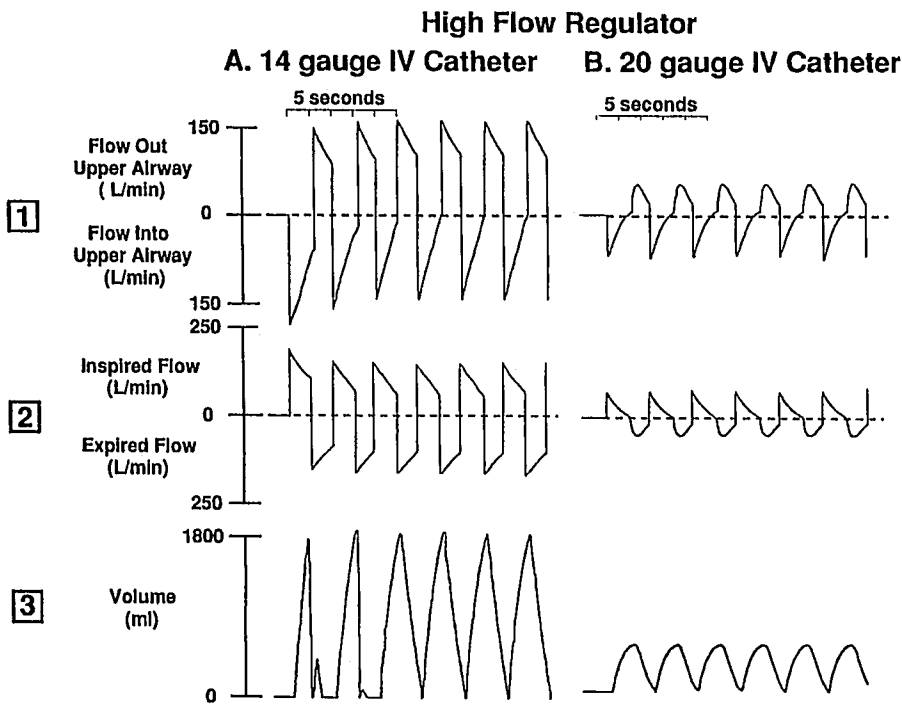

FIG. 2. Panels 1-3 are the strip-chart recordings for the high-flow regulator set at 50 psi for the 14- and 20-G IV catheters (A and B, respectively) at a lung compliance (C_{set}) = 50 ml/cmH₂O and an inspiratory:expiratory ratio = 1:1 (unit of time = 1 s). Panel 1 represents the entrained air flow; a deflection below the zero line corresponds to movement of air into the lungs, and deflections above the zero line correspond to movement of air out of the lungs. Panel 2 illustrates total gas flow into the lungs, *i.e.*, flow from entrained air and jetted oxygen. The total flow waveform produced by both regulators through both catheters consisted of a peak followed by a decay of flow, and these flows along with the tidal volume decayed over the first few breaths and then remained constant (steady state). The peak flow was lower and the slope of the decay from the peak flow to the lower flow rate was more gradual using the high-flow regulator (compared to the low flow regulator; see fig. 3) for all tested experimental conditions. The relationship between the peak flow rate and decay of flow (area under the curve in

panel 2) determined the tidal volume generated (panel 3). The small positive deflections immediately following the first two 14-G jet-ventilation tidal volumes represent resetting of the volume scale and must be added to the immediately preceding large positive deflection in order to read the total tidal volume for each of these two jet ventilation breaths. It is important to note that if the inspired flow and entrained flow curves were extrapolated to 3 s, then inspiration would end prior to this 3-s interval, and there would be a reversal of entrained flow.

tively. Panel 2 represents total flow into the bellows, *i.e.*, flow from air entrainment plus flow from the jet ventilation catheter. Panel 3 is the integration of the area under

the total flow curve (panel 2) to yield V_T . A significant decay was observed from the peak flow to a lower flow rate with each breath, and there was a slight decay in the

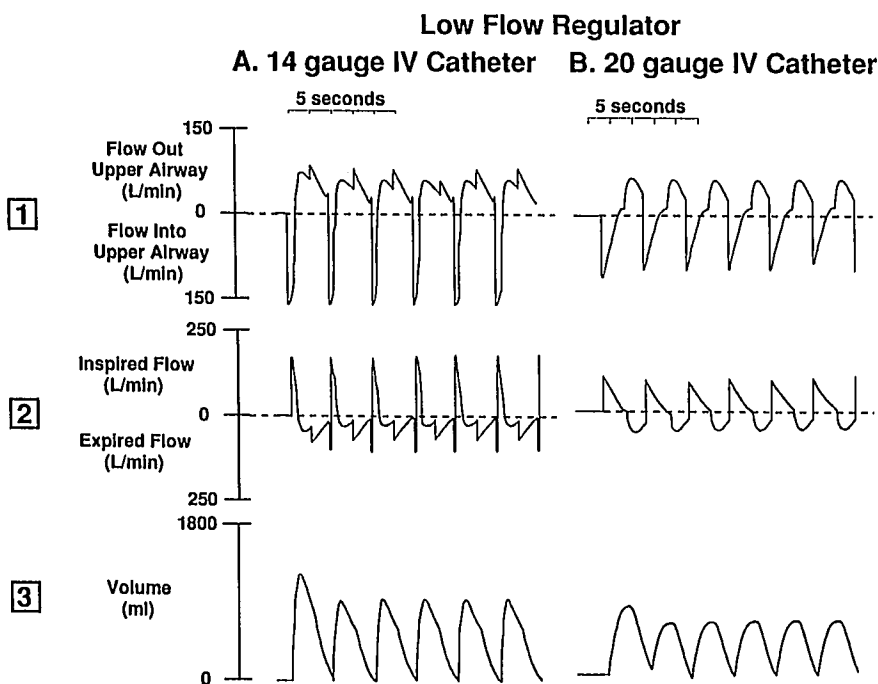

FIG. 3. Panels 1-3 are the strip-chart recordings for the low-flow regulator set at 120 psi with the 14- and 20-G intravenous catheters (A and B, respectively) at a C_{set} = 50 ml/cmH₂O at an inspiratory:expiratory ratio = 1:1 (unit of time = 1 s). Panel 1 represents the entrained air flow; a deflection below the zero line corresponds to movement of air into the lungs, and deflections above the zero line correspond to movement of air out of the lungs. Panel 2 illustrates total gas flow into the lungs, *i.e.*, flow from entrained air and jetted oxygen. The total flow waveform produced by both regulators through both catheters consisted of a peak followed by a decay in flow, and these flows along with the tidal volume decayed over the first few breaths and then remained constant (steady state). The peak flow was higher and the slope of the decay from the peak flow to the lower flow rates was steeper using the low-flow regulator (compared to high flow regulator; see fig. 2) for all tested experimental conditions. The relationship between the peak flow rate and decay of flow (area under the curve in panel 2) determined the tidal volume generated (panel 3). Note that inspired flow discontinues prior to 1 s and that at the same time, there is reversal of entrained flow.

peak flow and V_T over the first few breaths (see panels 2 and 3 in figs. 2 and 3) for every experimental condition. Steady-state conditions were defined as stable peak flow rates and V_T .

Figure 4 compares the calculated FA_{O_2} versus the measured FA_{O_2} at I:E = 1:1. The linear regression equation $y = 1.028x + (-0.007)$ was nearly the same as the line of identity, and the variables were closely correlated ($r^2 = 0.90$). Air entrainment ranged between 15–74% of V_T but constituted the largest percentage of V_T for the normal airway diameter A. Thus, all the low FA_{O_2} data points are associated with airway A (permitted most air entrainment), whereas the vast majority of high FA_{O_2} data points are associated with airways B, C, and D (less air entrainment contributing to total V_T).

The effect of varying C_{set} on V_T at an I:E = 1:1 is shown in figure 5. With both regulators, as C_{set} increased from 10–100 ml/cmH₂O, V_T increased. For each regulator, at a given C_{set} the V_T generated through the 14-G catheter was greater than that through the 20-G catheter. At $C_{set} = 100$ ml/cmH₂O, with the HFR/14-G iv catheter combination the $V_T + EEV$ exceeded total lung capacity (4,000 ml), and therefore the V_T could not be measured. At all C_{set} with the 20-G iv catheter, the LFR produced slightly greater (5–10%) V_T than the HFR, whereas with the 14-G iv catheter the HFR produced a much greater (approximately 100%) V_T than the LFR.

Figure 6 shows the effect of narrowing bronchial and tracheal diameters on V_T for $C_{set} = 50$ ml/cmH₂O at I:E = 1:1. The reference airway diameter is A with a tracheal diameter of 15 mm and a bronchial diameter of 9 mm. Narrowing the bronchial diameter to 4.5 mm (airway diameter B) resulted in an approximately 50% de-

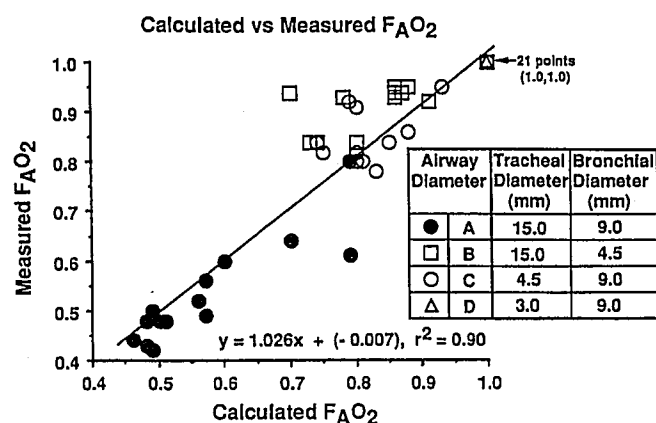

FIG. 4. The x axis is the calculated FA_{O_2} (based on air entrainment and total tidal volume), and the y axis is the measured FA_{O_2} . The linear regression equation is $y = 1.026x + (-0.007)$, $r^2 = 0.90$ with a P value = 0.0001. Airway A (normal diameter) allowed the most air entrainment and was associated with the lowest FA_{O_2} values, whereas the converse was true for airways B, C, and D.

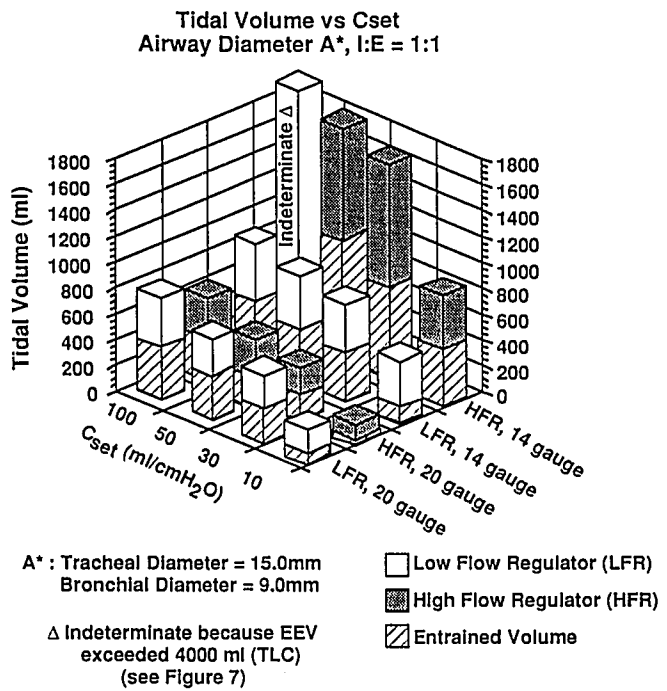

FIG. 5. The effect of changing compliance (C_{set} , x-axis) on tidal volume (y-axis) is illustrated for all four possible regulator/intravenous catheter combinations (z-axis) for the normal lung airway diameter A at inspiratory:expiratory ratio = 1:1. As compliance increases, tidal volume increases for every regulator/intravenous catheter combination. The tidal volume (V_T) generated through the 14-G intravenous catheter was greater than through the 20-G intravenous catheter for each regulator. End-expiratory volume exceeded TLC (4,000 ml) at a $C_{set} = 100$ ml/cmH₂O with the high-flow regulator/14-G intravenous catheter combination, and therefore V_T could not be determined. With the 20-G catheter, the low-flow regulator produced greater V_T s than the high-flow regulator, whereas with the 14-G intravenous catheter, the high-flow regulator produced greater V_T s than the low-flow regulator. The entrained volume is represented by the diagonally striped bars as a portion of total V_T for each experimental condition. The contribution of entrained air to total V_T ranged from 27 to 63% and from 27 to 68% for the 14- and 20-G intravenous catheters, respectively, with the low-flow regulator and from 38 to 56% and from 18 to 66% for the 14- and 20-G intravenous catheters, respectively, with the high-flow regulator.

crease in V_T for all regulator/iv catheter combinations. Inserting point tracheal resistances of 4.5 and 3.0 mm (airway diameters C and D, respectively) resulted in a lower V_T with all regulator/iv catheter combinations as compared to airway diameter A, and the tidal volumes generated through airway diameter C were greater than through airway diameter D. At all airway diameters, the LFR produced a slightly greater (10–15%) V_T than did the HFR with the 20-G iv catheter, whereas the HFR produced a much greater (100%) V_T than did the LFR with the 14-G iv catheter.

Figures 7 and 8 illustrate the effects of varying C_{set} (with airway A) and resistances (with $C_{set} = 50$ ml/

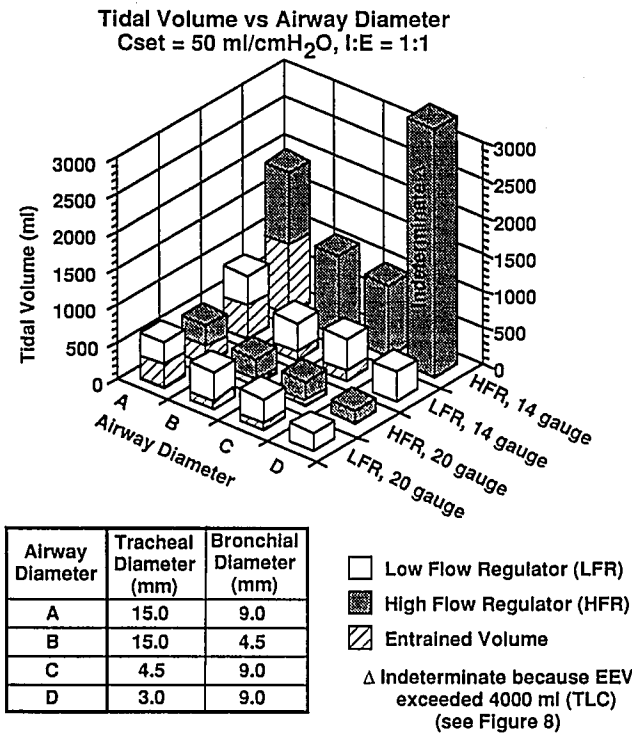

FIG. 6. The effect of changing airway diameter (x-axis) on tidal volume (y-axis) for all four possible regulator/intravenous catheter combinations (z-axis) at C_{set} = 50 ml/cmH₂O at an inspiratory:expiratory ratio = 1:1 is shown. Airway diameters A, B, C, and D are defined in the table inset below the x-axis. Decreasing both bronchial and tracheal diameters (B, C, and D) from reference airway diameter (A) resulted in progressively lower tidal volumes (V_T). For all airway diameters, the largest tidal volume for the 20-G intravenous catheter and 14-G intravenous catheter was obtained using the low-flow regulator and high-flow regulator, respectively. A V_T could not be determined for the high-flow regulator/14-G intravenous catheter combination with airway D because EEV surpassed the capacity of the mechanical lung (4,000 ml; see fig. 7). The entrained volume is represented by the diagonally striped bars as a portion of the total V_T for each experimental condition. The contribution of entrained air to total V_T ranged from 0 to 56% and from 0 to 64% for the 14- and 20-G intravenous catheters, respectively, with the high-flow regulator and from 0 to 62% and from 0 to 65% for the 14- and 20-G intravenous catheters, respectively, for the low-flow regulator.

cmH₂O), respectively, on EEV at I:E = 1:1. Increasing C_{set} caused an increased EEV. The greatest increase was with the HFR/14-G iv catheter combination; the EEV exceeded 4,000 ml at a C_{set} = 100 ml/cmH₂O. In comparing the effect of the regulators, a higher EEV resulted when using a LFR with the 20-G catheter and using a HFR with the 14-G catheter. In general, as V_T increased (fig. 5), EEV increased (fig. 7).

Narrowing either the bronchial (airway diameter B) or proximal tracheal (airway diameters C and D) diameters resulted in a greater EEV as compared to the reference airway diameter A (fig. 8). EEV exceeded 4,000 ml with

airway diameter D (point tracheal resistance of 3.0 mm) using the HFR/14-G iv catheter combination.

In table 1 the V̇_E are displayed for all test conditions at I:E = 1:1 (respiratory rate = 30 breaths/min). As would be predicted from the V_T obtained, the V̇_E using the 14-G iv catheter was higher with the HFR than with the LFR, and for the 20-G iv catheter the V̇_E was higher with the LFR than with the HFR at any comparative C_{set} and airway diameter. The lowest V̇_E for any experimental condition with the LFR was 6.0 l/min.

Figures 9 and 10 show the effect of varying the I:E ratio on V_T and EEV, respectively, for the 14-G catheter at C_{set} = 50 ml/cmH₂O for both airway diameter A (panel A) and airway diameter D (panel B). With airway D and the HFR at I:E ratios of 1:1 and 3:1, EEV exceeded total lung capacity, and therefore V_T was indeterminate. With airway A and the HFR, large tidal volumes were obtained at all three I:E ratios, but the EEV never exceeded total lung capacity (4,000 ml). The tidal volumes and EEV were always lower with the LFR than with the HFR for both airway diameters. Table 2 shows the calculated V̇_E for the three I:E ratios. The largest V̇_E were obtained with the HFR as compared to the LFR, airway A as compared to airway D, and I:E = 1:1 as compared to the other I:E ratios. A V̇_E could not be calculated using the HFR at

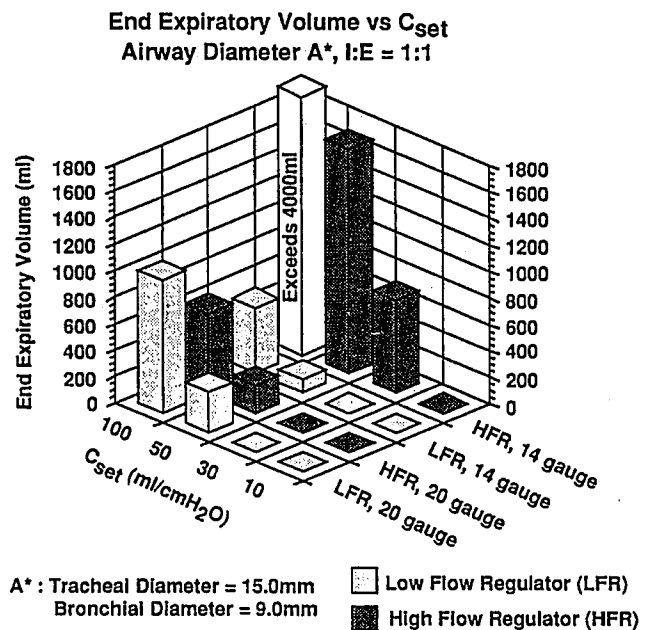

FIG. 7. The effect of varying lung compliance (C_{set}, x-axis) on end-expiratory volume (y-axis) for all four possible regulator/intravenous catheter combinations (z-axis) for airway diameter A at an inspiratory:expiratory ratio = 1:1 is shown. With increasing compliance there is an increase in end-expiratory volume with every regulator/intravenous catheter combination. The high-flow regulator/14-G intravenous catheter combination at a C_{set} = 100 ml/cmH₂O resulted in an end-expiratory volume greater than 4,000 ml.

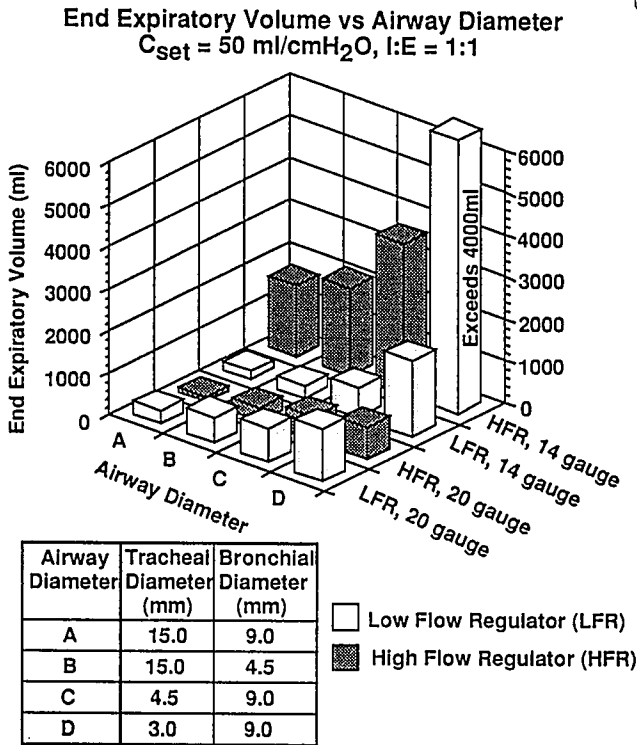

FIG. 8. The effect of varying the airway diameter (x-axis) on end-expiratory volume (y-axis) for all four possible regulator/intravenous catheter combinations (z-axis) at $C_{set} = 50 \text{ ml/cmH}_2\text{O}$ and inspiratory: expiratory ratio = 1:1 is shown. Airway diameters A, B, C, and D are defined in the table inserted below the x-axis. Narrowing of both bronchial and tracheal diameters resulted in greater lung volumes at end expiration as compared to normal airway diameter A for all regulator/intravenous catheter combinations. Airway diameter D caused larger end-expiratory volumes compared to airway diameter C, with end-expiratory volume exceeding 4,000 ml with the high-flow regulator/14-G intravenous catheter combination.

I:E = 1:1 and 3:1 through airway diameter D because EEV exceeded total lung capacity.

Discussion

Our measurements clearly demonstrate the effect of varying lung compliance and airway resistance on the jet ventilation V_T produced by HFRs and LFRs. Based on these results, conclusions can be drawn regarding the probable efficacy of TTJV with a LFR and different iv catheters in various clinical conditions. Prior to explaining and discussing these results, consideration should first be given to possible limitations in our experimental designs and methods.

We believe our \dot{V} and V_T measurements were accurate. The pressure in the HFR and LFR was independently measured with a precision gauge. We further validated the use of the HFR attached to an E cylinder as our reference high-flow control by comparing the \dot{V} and V_T

generated by both central wall pressure and the HFR (set to equal central wall pressure exactly) under a variety of test conditions, including maximum stress conditions, *i.e.*, 20-G iv catheter, $C_{set} = 10 \text{ ml/cmH}_2\text{O}$, and a 3.0-mm point tracheal resistance. In every situation, we obtained identical flow profiles, flow rates, and V_T . The electronic timing of the I:E ratios were confirmed oscilloscopically. The jet ventilating iv catheters were securely cemented into the sampling port of the male-female elbow outlet so that they projected into the center of the female outlet and catheter movement (whip) with jet injection was minimal. The integration of \dot{V} to V_T was electronic and independently checked by known flows for known periods of time. In addition, we planimtered a large random sample of flow curves and found the electronic integration of \dot{V} to V_T to be within 5% of the planimtered value. The strip-chart recording flow scale was 0–250 l/min for both inspiration and exhalation and could be read with accuracy to $\pm 5 \text{ l/min}$, which represents a 2% full-scale error and 4% half-scale error. The V_T strip-chart recording could be read to $\pm 20 \text{ ml}$ on a 0–2-l scale that represents 1% full scale error and a 2% half scale error.

Consideration should be given to the clinical relevance of mechanical lung model. Our “normal” tracheobronchial tree (airway diameter A) had internal diameters and lengths similar to an adult human. We included an upper airway mixing chamber (for air entrainment and reversal of jetted flow) that had a moderate distensibility. Our mechanical lung model allowed us to vary C_{set} and airway resistance over a wide range of values. It included a progressively constricted trachea at one small region (point) proximal to the entry of the test iv catheter (simulating a supraglottic mass, proximal tracheal stenosis, or laryngeal obstruction) and a diffusely increased lower airway resistance (simulating bronchospasm). However, the physiologic relevance of our model was limited by the fact that C_{set} was lung-volume-independent, whereas *in vivo* lung compliance is lung-volume-dependent (*i.e.*, an increase in lung volume increases lung elastic recoil creases compliance, which would limit the increase in EEV secondary to elevated alveolar pressures). Consequently, given the same initial lung compliance, the volume-dependent compliance of the human respiratory system should allow for less increase of EEV with TTJV than does our lung model. Nevertheless, although our results may not be quantitatively applicable to the healthy or diseased human respiratory system, the data from our model does answer the basic question of the ventilatory function of a LFR and the effects of a widely varying C_{set} and airway resistance and, in this regard, bears certain similarities to various clinical situations.

The V_T produced during jet ventilation was greatly dependent on the entrainment of air, which ranged from 15–74% of V_T . The volumes entrained were further val-

TABLE 1. Minute Ventilation

Intravenous Catheter	Airway Diameter	Minute Ventilation (l/min)							
		HFR Compliance				LFR Compliance			
		100	50	30	10	100	50	30	10
14-G	A	IND	54.0	49.8	25.2	27.6	25.8	22.2	14.4
	B	IND	32.4	30.0	22.2	15.0	15.0	14.4	10.2
	C	IND	28.8	26.4	24.0	15.6	16.8	16.2	12.0
	D	IND	IND	16.2	18.0	IND	12.0	10.8	9.6
20-G	A	19.2	15.6	12.0	4.2	23.4	18.6	18.6	7.8
	B	10.8	10.2	9.6	4.2	15.0	15.0	13.2	6.0
	C	10.2	9.6	8.4	4.2	12.6	12.0	10.8	9.0
	D	5.4	5.1	4.8	4.0	6.0	7.2	6.6	6.6

Airway Diameter	Tracheal Diameter (mm)	Bronchial Diameter (mm)
A	15.0	9.0
B	15.0	4.5
C	4.5	9.0
D	3.0	9.0

Minute ventilation = tidal volume \times 30 breaths/min (inspiratory: expiratory = 1:1).

HFR = high-flow regulator; LFR = low-flow regulator; IND = in-

determinate because end-expiratory volume exceeded total lung capacity (4,000 ml).

idated by comparing the measured steady-state FA_{O_2} to the FA_{O_2} that was calculated based on the entrained and total V_T . The calculated FA_{O_2} formula makes the assumption that all the entrained gas is air ($FI_{O_2} = 0.21$), which does not take into account the filling of the upper airway tubing with "exhaled" gas (which has an $FI_{O_2} > 0.21$). However, the linear regression line was nearly the same as the line of identity, with $r^2 = 0.90$, and thus, any over- or underestimation of FA_{O_2} based on the assumption that entrained gas has an $FI_{O_2} = 0.21$ is very small. Airway A permitted the most air entrainment and was associated with the lowest FA_{O_2} . Conversely, decreased bronchial and tracheal diameters (airways B, C, and D) allowed less entrainment of air (and therefore lower V_{T_S} [fig. 6]) and were associated with an increased FA_{O_2} . Thus, both FA_{O_2} and entrained \dot{V} and V_T were consistent with one another and confirm the importance of air entrainment and its contribution to total V_T .

The V_T was obtained by integrating the area under the flow curve. The LFR (initial pressure = 120 psi) produced higher peak flows than the HFR (initial pressure = 50 psi) for every tested experimental condition. If the flow profiles were square-wave (no or little evidence of decay), then it would be logical to expect that the greater the peak flow rate, the larger the integrated V_T . However, the flow curves produced by both regulators consisted of a peak flow followed by a rapid decay of flow. The slope of the decay from the peak to the lower flow rate was always steeper with the LFR than with the HFR (compare row 2 in fig. 2 with row 2 in fig. 3). In fact, in some circumstances the decay from the peak to the lower flow rate using the LFR was so extreme that the flow rate

decreased to zero before the end of the inspiratory period (figs. 3A and 3B, row 2).

The decay in the flow rate is explained by the mechanism of operation of HFR and LFR. Before flow is allowed to begin, the regulator is set at a predetermined pressure by manipulating the flow rate adjustment knob. When the jet ventilator valve is activated or opened, gas flows out of the regulator chamber, resulting in a decrease in the regulator chamber volume. The decrease in the regulator chamber volume causes, in sequence, a decrease in regulator chamber pressure, descent of the regulator diaphragm, and, through movement of the attachment lever, opening of the high pressure (tank) inlet valve. The inlet valve will stay open and continually supply gas to the regulator chamber until flow is no longer permitted (*i.e.*, the jet injector is deactivated or closed). The efficiency with which the tank can supply gas to the regulator chamber and maintain regulator volume is dependent on the resistance to flow in and out of the regulator chamber. The orifice of the high-pressure inlet valve of the HFR (8.29 mm²) is much larger than the orifice of the jet injector valve (2.9 mm²) (which is, in essence, the relevant regulator chamber outlet orifice because the actual chamber outlet orifice is larger than the jet injector orifice); therefore, flow from the high-pressure inlet valve can easily supply gas to fill the regulator chamber. The LFR has a much smaller high pressure inlet valve orifice (0.82 mm²) compared to the jet injector orifice, so that with activation of the jet injector, the flow from the tank cannot keep up with the demand, and the regulator chamber is quickly depleted of volume, resulting in a rapid decay in the flow rate. In addition, if another resistance is placed distal to

14 Gauge IV Catheter, $C_{set} = 50 \text{ ml/cmH}_2\text{O}$

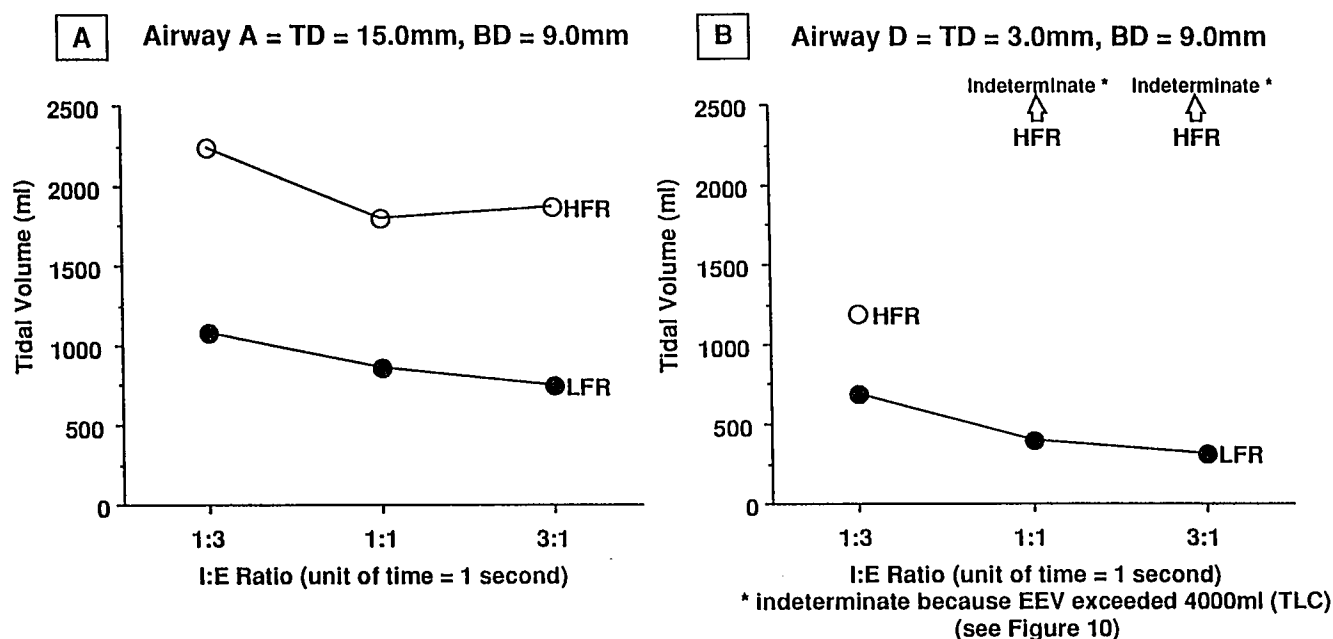

FIG. 9. The effect of changing the inspiratory:expiratory (I:E) ratio (x-axis) on tidal volume (y-axis) is illustrated for both the high- and low-flow regulators with the 14-G catheter at $C_{set} = 50 \text{ ml/cmH}_2\text{O}$. A shows the tidal volumes for airway diameter A (tracheal diameter [TD] 15 mm, bronchial diameter [BD] 9.0 mm), and B shows the tidal volumes for airway diameter D (TD 3.0 mm, BD 9.0 mm). No measurable tidal volume could be determined for airway diameter D using the high-flow regulator at I:E ratios of 1:1 and 3:1 because end-expiratory volume exceeded total lung capacity (4,000 ml) (see fig. 10).

14 Gauge IV Catheter, $C_{set} = 50 \text{ ml/cmH}_2\text{O}$

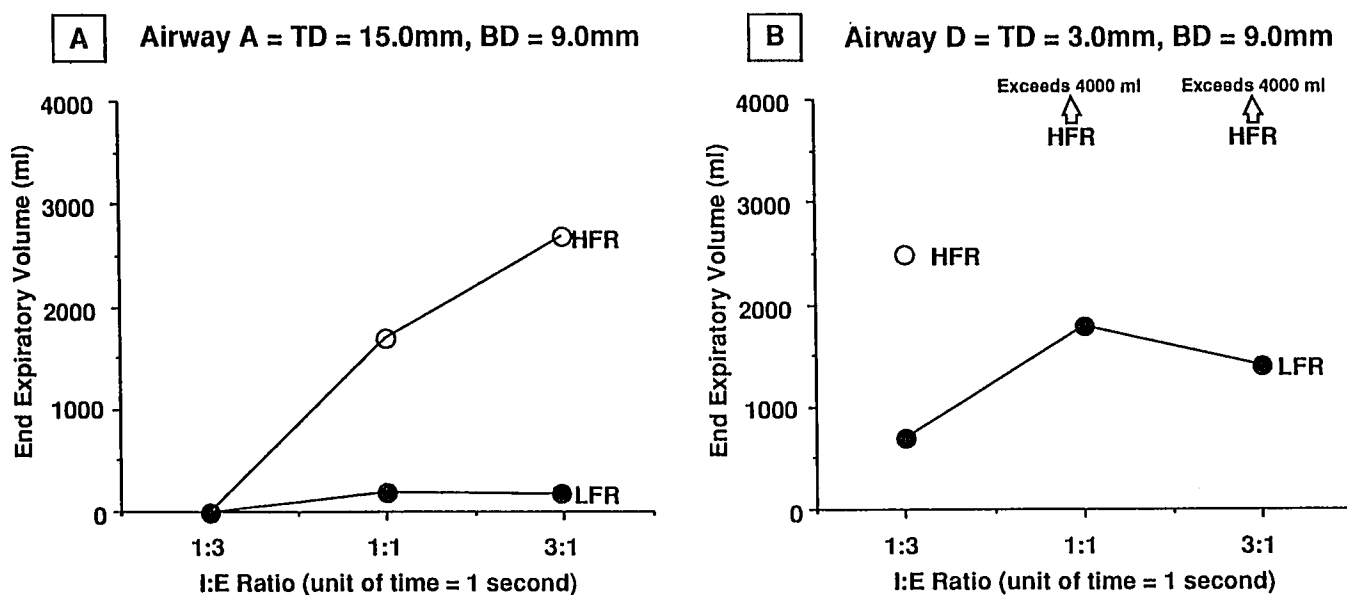

FIG. 10. The effect of changing the inspiratory:expiratory (I:E) ratio (x-axis) on end-expiratory volume (EEV) (y-axis) is shown for both the high- and low-flow regulators with the 14-G catheter at $C_{set} = 50 \text{ ml/cmH}_2\text{O}$ using airway diameter A (tracheal diameter [TD] 15 mm, bronchial diameter [BD] 9.0 mm, A) and airway diameter D (TD = 3.0 mm, BD = 9.0 mm, B). As expiratory time increased, from an I:E ratio of 1:1 to 1:3, EEV decreased for all experimental conditions. For the high-flow regulator, at an I:E = 3:1 with airway A, and I:E ratios of 1:1 and 3:1 with airway D, EEV exceeded the capacity of the mechanical lung (4,000 ml).

TABLE 2. Minute Ventilation (liters per minute) with 14-G Intravenous Catheter, C = 50 ml/cmH₂O

Inspiratory:Expiratory Ratio*	High-flow Regulator		Low-flow Regulator	
	Airway A	Airway D	Airway A	Airway D
1:3	33.6	18.0	15.2	10.5
1:1	54.0	†	25.8	12.0
3:1	28.2	†	11.4	4.8

Airway Diameter	Tracheal Diameter (mm)	Bronchial Diameter (mm)
A	15.0	9.0
D	3.0	9.0

* Unit of time = 1 s.

† EEV exceeds 4,000 ml.

the jet injector valve (*e.g.*, a small iv catheter), flow out of the regulator chamber is limited in proportion to the additional resistance; the decay of flow will be more gradual for the 20-G *versus* the 14-G iv catheter (compare fig. 3A with fig. 3B). In summary, the interaction of the peak flow (always higher with the LFR) and the rate of flow (always more gradual with the HFR and small iv catheter) determines the area under the flow curve and thus the V_T generated.

Decreasing tracheal and bronchial diameters (airways C, D, and B) from our reference model A resulted in a decrease in V_T at any given C_{set} (fig. 6). The decrease in V_T with narrowed bronchi is expected. The decrease in the proximal tracheal diameter decreased air entrainment and therefore total V_T , which was also reflected by an increased FA_{O_2} (fig. 6).

A small proximal tracheal and upper airway diameter not only promotes entry of jetted oxygen into the lungs (and limits air entrainment) but also prevents the exit of jetted oxygen and entrained air out of the lungs. The balance of the gas flow into and out of the lungs determines EEV; when inspiratory volume exceeds expiratory volume, EEV increases. An increase in EEV is associated with a higher "alveolar pressure," which supports a higher expiratory flow to establish a new equilibrium.

Increasing lung compliance and narrowing of both bronchial and tracheal airway diameters resulted in an increase in EEV at I:E = 1:1. Increasing the expiratory time from 1 to 3 s (I:E from 1:1 to 1:3), allowed the lungs adequate time to empty completely with airway diameter A (EEV = 0). With airway diameter D, the lungs never emptied completely because of the severely constricted upper airway; nevertheless, EEV was lowest when I:E = 1:3. A previous study has revealed that when the effective tracheal diameter decreases to less than 4.0–4.5 mm, the time for exhalation rapidly becomes prolonged.⁹ Therefore, increasing expiratory time even further, to 4 or 5 s, might have resulted in an EEV approaching zero.

Regardless of the lung compliance and resistance, during jet ventilation the chest should be continuously observed to rise and fall in a normal manner to allow detection of significant increases in EEV, which greatly increase the potential for barotrauma and adverse hemodynamic consequences. Consequently, an on-line adjustment of the I:E ratio may be necessary based on clinical observations of chest excursion during transtracheal jet ventilation, to avoid possible iatrogenically induced compromise.

The I:E ratio is also important in calculating \dot{V}_E . At I:E ratios of 1:3, 1:1, and 3:1 (unit of time = 1 s), the respiratory rates are 15, 30, and 15 breaths/min, respectively. For both the HFR and LFR the greatest \dot{V}_E volumes always were obtained at I:E = 1:1. The decrease in V_T at I:E = 1:3 *versus* at I:E = 3:1 is due primarily to the reversal of entrained flow during inspiration (fig. 3a). Based on this consideration and the previous discussion of the dynamic characteristics of the LFR, the 1st s of inspiration is more effective in delivering volume than subsequent seconds (fig. 3), and thus the optimal pattern for jet ventilation with the LFR is I:E = 1:1.

The flow characteristics of the HFR are different from the LFR, which accounts for the significantly greater \dot{V}_E obtained for the identical experimental conditions with the 14-G catheter (table 1). The highest \dot{V}_E was 54 l/min and occurred at an I:E = 1:1. In fact, many of the experimental situations with the HFR resulted in very high levels of ventilation, which could certainly lead to adverse clinical sequelae associated with dynamic hyperinflation. Figure 10 illustrates the increase in EEV in changing from an I:E ratio of 1:3 to 3:1 for airway diameters A and D. Decreasing the I:E from 1:1 to 1:3 requires a decrease in respiratory rate from 30 to 15 breaths/min, which results in substantially lower \dot{V}_E ; nevertheless, these \dot{V}_E are settings at values high enough to supply total ventilatory support in the vast majority of clinical situations (table 2). In addition, the longer expiratory time allowed for more complete emptying of the lungs prior to the next jet ventilation breath, which resulted in a lower EEV. Therefore, with regard to both a favorable \dot{V}_E and EEV during TTJV, it would seem reasonable to use an I:E ratio of 1:3 with the HFR.

In a given clinical situation we do not know exactly what level of ventilation is necessary to provide an adequate amount of gas exchange. For every experimental condition we tested, the lowest \dot{V}_E was 4.0 l/min (HFR/20-G iv catheter, C_{set} = 10 ml/cmH₂O; table 1), which probably would suffice for effective short-term ventilation in most children and adults if metabolic requirements are low or if some spontaneous ventilation is present. However, if total ventilatory support is necessary (*e.g.*, the adult patient is apneic or paralyzed), such that the patient's required \dot{V}_E was progressively greater, then the number of experimental conditions that could provide total ventilatory support would become limited (tables 1 and 2).

These findings have several implications for TTJV in clinical practice. First, a HFR (*i.e.*, wall pressure, anesthesia machine with a flush valve and without a system pop-off valve⁴) should be used whenever possible because of the greater V_T obtained. The optimal I:E ratio with a HFR is 1:3, which provides for adequate ventilatory support in the vast majority of clinical situations and limits excessive increases in EEV and associated complications. Second, if a LFR must be used (*i.e.*, in patient rooms, hallways, and emergency and intensive care rooms that do not have a dedicated oxygen wall outlet; in many specialized diagnostic and therapeutic areas; and for out-of-hospital resuscitation), the flow should be set at the maximum of 15 l/min to ensure adequacy of V_T , and an I:E ratio of 1:1 should be used because it yields the greatest \dot{V}_E . Third, in patients with a severe proximal tracheal narrowing and normal lung compliance, one must be very careful with

jet ventilation through a 14-G iv catheter in order to avoid very large tidal volumes and EEV barotrauma. Overall, our results validate the effectiveness and usefulness of a LFR for TTJV in a variety of common clinical situations.

References

1. Benumof JL, Scheller MS: The importance of transtracheal jet ventilation in the management of the difficult airway. *ANESTHESIOLOGY* 71:769-778, 1989
2. Bellhouse CP, Dore C: Criteria for estimating likelihood of difficulty of endotracheal intubation with MacIntosh laryngoscope. *Anaesth Intensive Care* 16:329-337, 1988
3. Dworkin R, Benumof JL: The effective tracheal diameter that causes air trapping during jet ventilation. *J Cardiothorac Anesth* 4:731-736, 1990
4. Gaughan SD, Benumof JL, Ozaki G: Can an anesthesia machine flush valve provide for effective jet ventilation (abstract). *ANESTHESIOLOGY* 74A:S130, 1991