

# On-line Monitoring of End-tidal Propofol Concentration in Anesthetized Patients

Akira Takita, M.D.,\* Kenichi Masui, M.D., Ph.D.,† Tomiei Kazama, M.D., Ph.D.‡

**Background:** Propofol (2,6-diisopropylphenol) has some volatility, so it can be detected in expired breath of individuals receiving intravenous propofol. This study measured volatile propofol exhaled by patients and investigated the relation between exhaled and plasma propofol concentrations.

**Methods:** Nineteen patients with American Society of Anesthesiologists physical status I or II who were undergoing elective surgery participated in this two-part study. In study 1 (n = 11), anesthesia was induced with 2 mg/kg propofol, 0.1 mg/kg vecuronium, and 2 µg/kg fentanyl. After intubation, propofol was administered continuously for 60 min at each of three rates: 3, 6, and 9 mg · kg<sup>-1</sup> · h<sup>-1</sup>. Blood samples were obtained just before each change in the infusion rate, and the plasma concentrations of propofol were measured. The exhaled propofol concentration was measured continuously by means of proton transfer mass spectrometry. End-tidal propofol concentrations during blood sampling were averaged and compared with plasma propofol concentrations. In study 2 (n = 8), after induction of anesthesia, patients received a bolus injection of 2 mg/kg propofol, and the exhaled propofol concentration was measured.

**Results:** Volatile propofol was detected in expired gas from all study patients. From study 1, the authors obtained 24 paired data points, *i.e.*, concentrations of end-tidal and plasma propofol. With Bland-Altman analysis, bias ± precision was 5.2 ± 10.4 with 95% limits of agreement of -15.1 and 25.6. In study 2, the exhaled propofol concentration curve showed an obvious peak in all patients.

**Conclusions:** Agreement between plasma and exhaled propofol concentrations suggests that proton transfer mass spectrometry can be used for real-time propofol monitoring.

MONITORING concentrations of intravenous anesthetics, such as propofol, during anesthesia or sedation of patients in the intensive care unit is important, but unlike monitoring of volatile anesthetics, monitoring of intravenous anesthetics is not easily performed. To estimate the concentration of propofol in the bloodstream of anesthetized patients, we use the target-controlled infusion technique based on computer-simulated pharmacokinetics. However, the computer generates a pre-

dicted, not actual, value, and the difference is often apparent in the clinical setting.

Propofol has a phenolic chemical structure and thus, in theory, is somewhat volatile.<sup>1,2</sup> The volatility is obvious from the distinctive odor, but the boiling point of propofol is so high (256°C)<sup>3</sup> that the concentration of volatile propofol from solution is extremely low. The technical difficulty of measuring volatile propofol concentrations in real time in anesthetized patients is so great that there has been no device available for this purpose. However, the proton transfer reaction mass spectrometer (PTR-MS)<sup>4,5</sup> is a relatively new device that depends on the proton transfer reaction to quantify volatile organic compounds (VOCs) in air at extremely low concentrations and in real time.

Harrison *et al.*<sup>6</sup> reported that intravenously administered propofol can be detected in a patient's breath. However, theirs was a pilot study involving only one patient, and the relation between the concentration of exhaled propofol and that of propofol in the blood was not evaluated.

We conducted a two-part study to investigate whether volatile propofol can be detected with a PTR-MS in gas exhaled by patients receiving propofol intravenously and to investigate the relation between the exhaled volatile propofol and plasma propofol concentrations.

## Materials and Methods

The study protocol was approved by the institutional ethics committee (Committee on Clinical Research, National Defense Medical College, Tokorozawa, Japan), and written informed consent was obtained from all patients who participated.

### Patients and Anesthetic Management

**Study 1.** Eleven patients with American Society of Anesthesiologists physical status I or II agreed to participate in the study. All were scheduled to undergo elective surgery.

Induction of anesthesia included preoxygenation *via* a facemask, which was followed by bolus injection of 2 mg/kg propofol (Diprivan®; AstraZeneca, Osaka, Japan), 0.1 mg/kg vecuronium, and 2 µg/kg fentanyl, and tracheal intubation was performed. Propofol was then continuously infused at a rate of 3 mg · kg<sup>-1</sup> · h<sup>-1</sup> for 60 min, 6 mg · kg<sup>-1</sup> · h<sup>-1</sup> for the next 60 min, and 9 mg · kg<sup>-1</sup> · h<sup>-1</sup> for the final 60 min. After tracheal intubation, the lungs were ventilated (tidal volume = 10 ml/kg, respira-

This article is accompanied by an Editorial View. Please see: Kharasch ED: Every breath you take, we'll be watching you. ANESTHESIOLOGY 2007; 106:652-4.

\* Research Fellow of the Graduate Course of Medicine, † Assistant Professor, ‡ Professor and Chairman.

Received from the Department of Anesthesiology, National Defense Medical College, Tokorozawa, Japan. Submitted for publication May 23, 2006. Accepted for publication September 20, 2006. Support was provided solely from institutional and/or departmental sources.

Address correspondence to Dr. Takita: National Defense Medical College, Namiki 3-2 Tokorozawa, Saitama, Japan. a-tacky@bd5.so-net.ne.jp. Individual article reprints may be purchased through the Journal Web site, www.anesthesiology.org.

tory rate = 10 breaths/min, inspiration:expiration ratio = 1:2 with 6 l/min of oxygen-air mixture [fraction of inspired oxygen = 0.5]). A 22-gauge cannula was inserted into the left radial artery for blood sampling to measure plasma propofol concentrations and for blood pressure monitoring.

After intubation, a PTR-MS (Ionicon Analytik GmbH, Innsbruck, Austria) sampling tube (150 cm) was attached to the endotracheal tube, and exhaled gas was sampled at 60 ml/min from the endotracheal tube connector. The end-tidal propofol concentration was then measured. In addition, the temperature of exhaled gas was recorded by a digital thermometer with its probe connected to the endotracheal tube. These data were recorded simultaneously and saved on the hard drive of a personal computer. In all patients, analgesia was achieved by administration of an adequate amount of 0.5% ropivacaine into the epidural space *via* an epidural catheter placed at the lumbar level.

The plasma concentrations of propofol were predicted by a pharmacokinetic model based on parameters reported by Marsh *et al.*<sup>7</sup> to confirm that the steady state had been achieved at the time of sampling. The steady state was achieved after 60 min at each of the three infusion rates: 3, 6, and 9 mg · kg<sup>-1</sup> · h<sup>-1</sup>. At each infusion rate, blood was sampled five times at 1-min intervals, and the average propofol concentration was determined. Simultaneously, the concentrations of exhaled propofol were recorded. End-tidal concentrations of 50 breaths during blood sampling were averaged, and this average was compared with the average plasma propofol concentration. At an infusion rate of 3 mg · kg<sup>-1</sup> · h<sup>-1</sup>, a Bispectral Index value above 70 was considered to indicate inadequate sedation, and the propofol infusion rate was then increased to the next higher level (6 mg · kg<sup>-1</sup> · h<sup>-1</sup>) to achieve an adequate depth of anesthesia. The study was terminated when surgery ended, even if infusion at all rates had not been performed. Blood samples were centrifuged immediately, and plasma propofol concentrations were measured by high-performance liquid chromatography (HPLC) within 24 h.

To assess the respiratory cycle, especially timing of the end-expiratory phase, we measured the temperature of exhaled gas with a BWT-100 (Bio Research Center, Nagoya, Japan) thermocouple digital thermometer. The probe was placed at the point of exhaled gas sampling to measure the temperature of the gas being analyzed. Concentrations of exhaled propofol were regarded as end-tidal concentrations at the time of end-tidal expiration determined on the basis of temperature.

**Exhaled Gas Sampling and Apparatus.** Exhaled volatile propofol was measured by means of a PTR-MS, a relatively new device that can detect extremely low concentrations of VOCs, including propofol, measurable in parts per trillion by volume. The PTR-MS allows con-

tinuous measurement at approximately 750-ms intervals during anesthesia. The sampling line was a Teflon tube (Flon Industry Co., Ltd., Tokyo, Japan) (1.5 m long, 1.59 mm ID) heated by a coil up to 70°C. Pressure in the drift tube of the PTR-MS was maintained at approximately 1.75 mbar, drift tube temperature was kept at approximately 70°C, and drift tube voltage was set at 520 V. The quantification of exhaled propofol is explained in detail in the appendix.

**Study 2.** Eight patients with American Society of Anesthesiologists physical status I or II agreed to participate in this study. All were scheduled to undergo elective surgery.

Induction of anesthesia included preoxygenation *via* a facemask, which was followed by bolus injection of 0.1 mg/kg midazolam, 0.1 mg/kg vecuronium, and 2 µg/kg fentanyl, and tracheal intubation was performed. After tracheal intubation, the lungs were ventilated and measurement of exhaled propofol concentrations was performed in the same way as in study 1. After measurement of the baseline exhaled propofol concentration, bolus injection of 2 mg/kg propofol followed by a 20-ml saline flush (time = 0) was performed. The concentration of exhaled propofol was measured continuously as described in study 1 for 30 min and recorded.

In all patients, adequate analgesia was achieved with epidural anesthesia in the same manner as in study 1. During the study, a Bispectral Index value greater than 70 was considered to indicate inadequate sedation, and an additional 0.05 mg/kg midazolam was administered if necessary.

**Measuring Plasma Propofol Concentrations by HPLC.** The HPLC apparatus consisted of a dual-head pump with an autoinjector (SIL-10AD; Shimadzu, Kyoto, Japan) serially connected to a spectrofluorometric detector (RF-550; Shimadzu). The spectrofluorometric detector was set with an excitation wavelength of 276 nm, an emission wavelength of 310 nm, and 15-nm slit widths. The HPLC mobile phase consisted of 40% methanol, 30% acetonitrile, and 30% water with a flow rate of 1.0 ml/min. To each 400-µl sample, 1.0 ml of a precipitating solution (acetonitrile) containing 1 µg thymol (internal standard) was added, and the sample was then mixed with a vortex mixer for 30 s. The mixed sample was centrifuged for 10 min at 14,000g, and 20-µl aliquots of the supernatant were injected into a 25 cm × 4.6 mm ID Inertsil ODS-3 HPLC column (GL Science, Tokyo, Japan). The detection limit of this apparatus is 10 ng/ml, and we confirmed the linearity from 50 ng/ml to 10 µg/ml before measurement ( $r^2 = 0.9998$ ).

#### Statistical Analysis

To examine the relation between the plasma concentration of propofol and the end-tidal concentration of propofol, single linear regression analysis of a total of 24 data points (representing all 11 study 1 patients) was

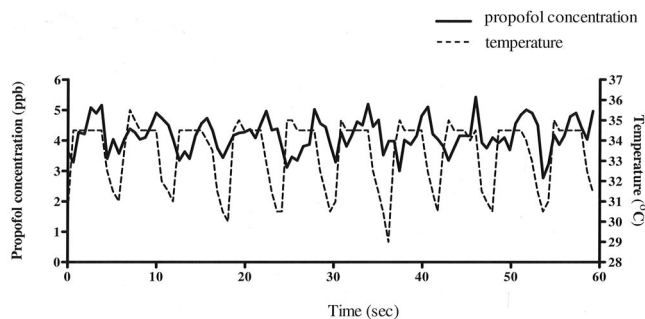

**Fig. 1.** Waveforms of breath temperature and propofol concentration. Examples of actual waveforms recorded in the current study are shown. The temperature of exhaled gas was measured simultaneously and displayed on the computer monitor with the exhaled propofol concentration. The *solid line* is the concentration of exhaled propofol, and the *broken line* is the temperature of the breathing gas.

performed. Agreement was assessed by the modified Bland-Altman method described by Mayevsky *et al.*<sup>8</sup> In a standard Bland-Altman analysis, the difference (y-axis) is plotted against the mean value for each subject (x-axis) on the assumption that all data are expressed in the same units. However, in this study, the units of measure differed ( $\mu\text{g/ml}$  and ppb). To permit direct comparison of values presented in different units, the data were normalized as the percentage of maximum values observed.

**Results**

*Study 1*

Volatile propofol was detected in expired gas from all patients who participated in the study. The propofol concentration curves were nearly synchronous with the respiratory cycles, as shown in figure 1. An example of an exhaled propofol concentration curve with achievement of steady state concentrations is shown in figure 2. The concentration increased as the infusion rate increased.

**Fig. 2.** Change in the exhaled propofol concentration. Typical change in the exhaled propofol concentration is shown by the waveform (*solid line*). The *broken line* indicates the plasma concentration of propofol predicted by computer simulation based on a pharmacokinetic model using the parameters of Marsh *et al.*<sup>7</sup> *Solid diamonds with error bars* indicate mean plasma concentrations of propofol measured by high-performance liquid chromatography. The *bar graph* at the bottom shows the propofol infusion rate. Bolus injection of 2 mg/kg propofol was performed at time 0. The exhaled concentration of propofol increased as the plasma concentration increased.

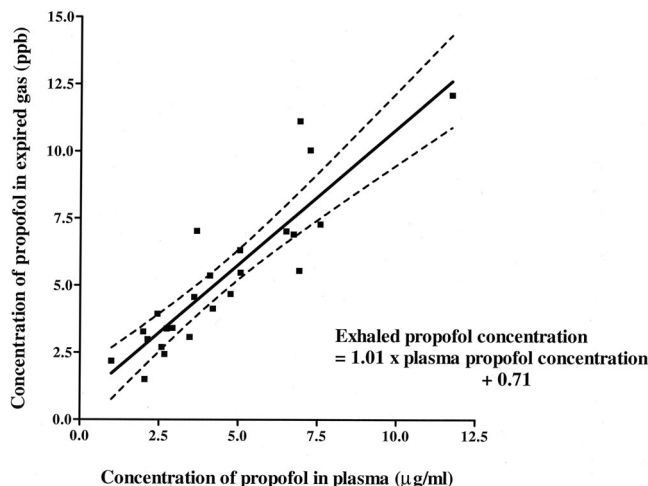
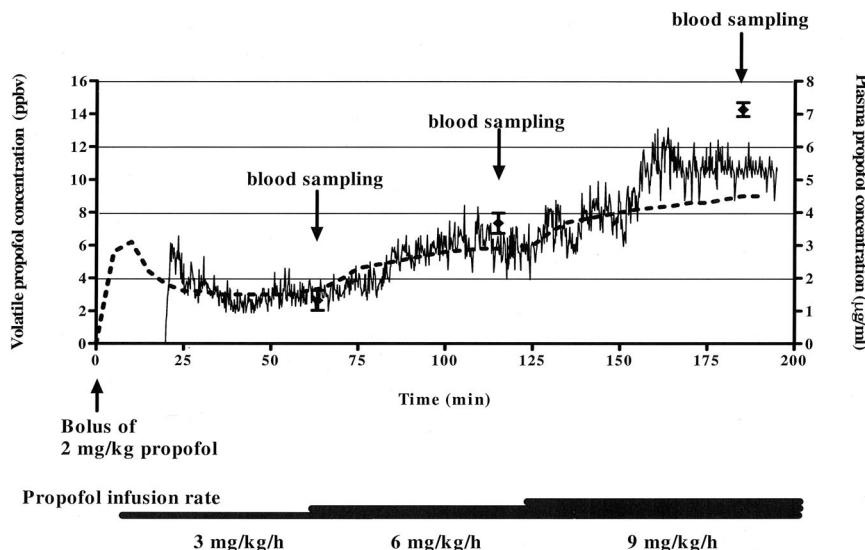

**Fig. 3.** Linear regression analysis of the concentrations of exhaled propofol and the plasma concentrations in 11 patients (24 total data points). Y-axis, average end-tidal exhaled propofol concentration of 50 breaths; x-axis, average plasma propofol concentration of five samples. Linear regression analysis was performed. The *solid line* is the regression line, and the *broken lines* indicate the 95% confidence interval.

The results of linear regression analysis are shown in figure 3.

For the entire data set, bias (mean ratio between simultaneous measurements)  $\pm$  precision (SD of the ratio between values) was  $5.2 \pm 10.4$ . With these values, the 95% limits of agreement (mean  $\pm$  2 SD of the ratio between simultaneous measurements) were  $-15.1$  and  $25.6$  (fig. 4).

*Study 2*

Before bolus injection of propofol, no volatile propofol was detected in breathing gas (signals at 179 AMU). After bolus injection, there was an obvious surge of exhaled propofol in all patients. The average time from time 0 to detection of volatile propofol was  $41.8 \pm 8.0$  s, and that

Downloaded from http://aas2.silverchair.com/anesthesiology/article-pdf/106/4/659/363807/0000542-200704000-00006.pdf by guest on 02 December 2023



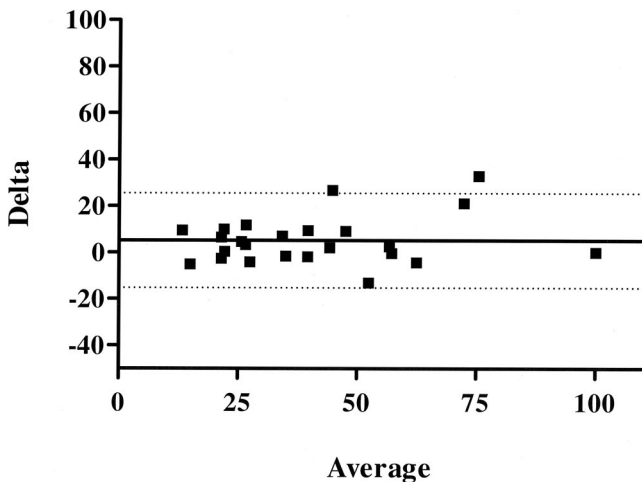

Fig. 4. Comparison of end-tidal propofol concentrations and plasma propofol concentrations according to the Bland-Altman method. Average = average value of the normalized end-tidal concentration of propofol and normalized plasma concentration of propofol; delta = difference between the normalized end-tidal concentration of propofol and normalized plasma concentration of propofol. Bias  $\pm$  precision was  $5.2 \pm 10.4$  (solid line) with 95% limits of agreement of  $-15.1$  and  $25.6$  (dotted lines).

from time 0 to peak concentration was  $333.8 \pm 70.0$  s (fig. 5).

## Discussion

We examined the end-tidal concentration of volatile propofol in anesthetized patients to determine whether it is related to the plasma concentration of propofol. According to our results, the end-tidal propofol concen-

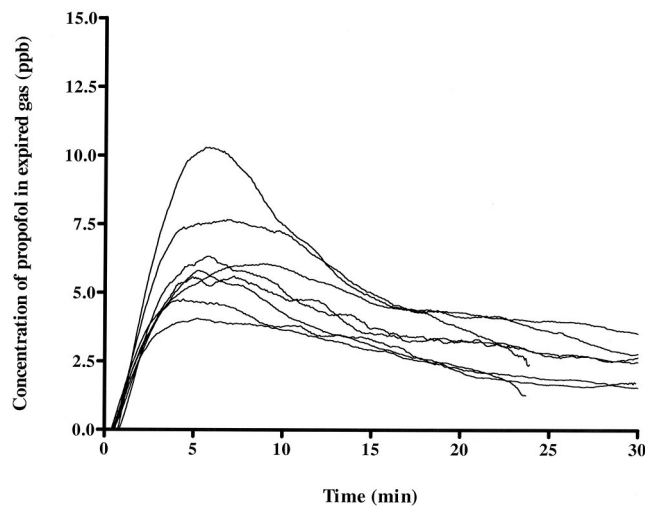

Fig. 5. The exhaled propofol concentration curve after bolus injection in study 2. After intubation, patients received a bolus injection of 2 mg/kg propofol (time 0). Exhaled propofol was measured with a proton transfer reaction mass spectrometer as described for study 1, and the moving averages of 10 data points are indicated here as solid lines. In all patients, we observed an obvious surge in exhaled propofol after administration of propofol.

tration and the plasma propofol concentration seem to be interchangeable.

Harrison *et al.*<sup>6</sup> reported detection of volatile propofol with a PTR-MS in gas exhaled by an anesthetized patient receiving propofol intravenously. They referred to the possibility of monitoring plasma propofol concentrations by measuring exhaled concentrations. The results of our current study strongly support this possibility. Harrison *et al.*<sup>6</sup> were the first to report that the PTR-MS can be used to measure propofol concentrations in clinical settings. They noted that increasing the voltage applied to the drift tube resulted in significant occurrence of collision-induced dissociation with protonated propofol ions. Therefore, we set the drift voltage at 520 V to suppress this dissociation in the current study. In a preliminary study, we confirmed, by comparing Diprivan<sup>®</sup> and 2,6-diisopropylphenol solution, that the observed peak at 179 AMU in PTR-MS analysis originates from propofol. This finding corresponds to that of Harrison *et al.*<sup>6</sup>

In a second study (study 2), we examined volatile propofol extraction in exhaled gas in the acute phase after induction of anesthesia after a single bolus injection of propofol. The concentration curves of exhaled propofol from eight patients after bolus injection of 2 mg/kg propofol are shown in figure 5. We observed an obvious surge in the exhaled volatile propofol concentration in all patients after bolus injection. Therefore, it is clear that propofol administered intravenously is eliminated through the respiratory system, even if the exhaled propofol concentration is very low.

After bolus injection, peak propofol plasma concentrations are presumably reached in less than a minute, but our data showed that peak concentrations of exhaled propofol are reached after approximately 5 min. At the present time, we attribute this delay to pulmonary elimination. Boer<sup>9</sup> stated in his review article that compounds with significant pulmonary uptake are basic amines with pKa values greater than 8, and many of the drugs used in anesthesia are basic amines. Propofol has a pKa value of 11, indicating a high likelihood of pulmonary affinity and uptake. We speculate that propofol taken into the lungs was gradually eliminated (emitted) into the airway, which would explain the delay. We are planning to investigate this phenomenon in the next study.

Why there is a delay between a change in the plasma propofol concentration and the corresponding change in the exhaled propofol concentration is unknown. Therefore, a steady plasma propofol concentration must be maintained during blood and gas samplings for comparison of the two values. In study 1, we administered propofol continuously for 60 min at each of the three rates of infusion to achieve a constant plasma concentration during the sampling periods. Computer simulation based on the parameters of Marsh *et al.*<sup>7</sup> confirmed

that the change in plasma concentration of propofol was minimal during each sampling period. To confirm that there was almost no change in the actual propofol concentration, we evaluated the concentration five times at 1-min intervals. We also averaged end-tidal propofol concentrations of 50 breaths during the same period. Variance in the values representing the five samples was considered acceptable. Fifty breath samples were needed for averaging because there was some graphical variation in the end-tidal propofol concentrations on the exhaled concentration curve, which differs from that of a capnogram.

In a study of expired alveolar gas in two animal models, Grossherr *et al.*<sup>3</sup> noted some problems associated with exhaled gas sampling. First, continuous side-stream sampling often results in measurement of mixed air instead of expired alveolar gas. To determine the concentration of some gases in exhaled air, we need a plateau in the concentration curve similar to that of end-tidal carbon dioxide in capnography. This problem can also be solved by using only end-expiratory breaths for analysis, as suggested by Grossherr *et al.*<sup>3</sup> To collect end-expiratory breaths, they used the carbon dioxide-controlled sampling method described by Schubert *et al.*<sup>10</sup> We addressed this problem by improving the response time of the measuring device to 750 ms. This allowed us to obtain a breath-to-breath exhaled propofol concentration curve that was nearly rectangular. In addition, to identify the end-tidal concentration more precisely, we measured the temperature of exhaled gas simultaneously and defined the end-expiratory phase on the basis of temperature, applying the principles described by Primiano *et al.*<sup>11</sup> As a result, we were able to accurately identify the end-tidal concentrations of propofol and use these concentrations for analysis.

The problem of the propofol concentration in the inspired phase not returning to the baseline value has yet to be resolved. Currently, we consider it to be due to residual volatile propofol in the sampling line and inner circuit of the apparatus. Grossherr *et al.*<sup>3</sup> also reported condensation on the inner wall of the sampling tube. We observed condensate in the sampling tube in our early trial, and such condensate makes the measurement inaccurate. We solved this problem by heating the sampling line with a heating coil up to 70°C. Therefore, in the current study, there was no condensation in the sampling line, and we were able to obtain accurate measurements.

## Conclusion

The agreement we observed between exhaled and plasma propofol concentrations confirms the possibility of monitoring plasma propofol concentrations clinically by measuring exhaled concentrations.

The authors thank Akio Shimono, Ph.D. (Sanyu Plant Service Co., Ltd., Sagami-hara, Kanagawa, Japan), for technical assistance.

## References

1. Vree TB, Baars AM, de Groot PM: High-performance liquid chromatographic determination and preliminary pharmacokinetics of propofol and its metabolites in human plasma and urine. *J Chromatogr* 1987; 417:458-64
2. Mather LE, Selby DG, Runciman WB, McLean CF: Propofol: Assay and regional mass balance in the sheep. *Xenobiotica* 1989; 19:1337-47
3. Grossherr M, Hengstenberg A, Meier T, Dibbelt L, Gerlach K, Gehring H: Discontinuous monitoring of propofol concentrations in expired alveolar gas and in arterial and venous plasma during artificial ventilation. *ANESTHESIOLOGY* 2006; 104:786-90
4. Hansel A, Jordan A, Holzinger R, Prazeller P, Vogel W, Lindinger W: Proton transfer reaction mass spectrometry: On-line trace gas analysis at the ppb level. *Int J Mass Spectrom Ion Processes* 1995; 149/150:609-19
5. Lindinger W, Hansel A, Jordan A: On-line monitoring of volatile organic compounds at pptv levels by means of proton-transfer-reaction mass spectrometry (PTR-MS): Medical applications, food control and environmental research. *Int J Mass Spectrom Ion Processes* 1998; 173:191-241
6. Harrison GR, Critchley AD, Mayhew CA, Thompson JM: Real-time breath monitoring of propofol and its volatile metabolites during surgery using a novel mass spectrometric technique: A feasibility study. *Br J Anaesth* 2003; 91:797-9
7. Marsh B, White M, Morton N, Kenny GN: Pharmacokinetic model driven infusion of propofol in children. *Br J Anaesth* 1991; 67:41-8
8. Mayevsky A, Manor T, Pevzner E, Deutsch A, Etzioni R, Dekel N, Jaronkin A: Tissue spectroscopy: A novel *in vivo* approach to real time monitoring of tissue vitality. *J Biomed Opt* 2004; 9:1028-45
9. Boer F: Drug handling by the lungs. *Br J Anaesth* 2003; 91:50-60
10. Schubert JK, Spittler KH, Braun G, Geiger K, Guttman J: CO<sub>2</sub>-controlled sampling of alveolar gas in mechanically ventilated patients. *J Appl Physiol* 2001; 90:486-92
11. Primiano FP Jr, Montague FW Jr, Saidel GM: Measurement system for respiratory water vapor and temperature dynamics. *J Appl Physiol* 1984; 56:1679-85

## Appendix: Quantification of Exhaled Propofol

A significantly large number of hydronium ions (H<sub>3</sub>O<sup>+</sup>) are generated stably by a hollow cathode discharge in the ion source region in the PTR-MS (fig. 6). Hydronium ions perform proton transfer with VOCs *via* the following reaction:

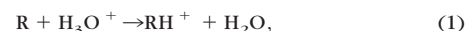

where R denotes the target VOC and all of the values are expressed in molecules/cm<sup>3</sup>. In the presence of a large excess of H<sub>3</sub>O<sup>+</sup> ions and a trace amount of the VOC (the concentration of H<sub>3</sub>O<sup>+</sup> ions [H<sub>3</sub>O<sup>+</sup>] >> the concentration of the VOC [R]), the proton transfer reaction (1) is expressed as a pseudo-first-order reaction. Under typical operating conditions, only a small fraction of H<sub>3</sub>O<sup>+</sup> ions react with VOCs, so that [RH<sup>+</sup>] << [H<sub>3</sub>O<sup>+</sup>] is always valid and [H<sub>3</sub>O<sup>+</sup>] ≈ [H<sub>3</sub>O<sup>+</sup>]<sub>0</sub>, where [H<sub>3</sub>O<sup>+</sup>]<sub>0</sub> is the concentration of H<sub>3</sub>O<sup>+</sup> ions before the reaction. The concentration of RH<sup>+</sup> ions, [RH<sup>+</sup>], is calculated as follows:

$$\begin{aligned} [RH^+] &= [H_3O^+]_0(1 - \exp[-k[R]t]) \\ &\approx [H_3O^+]k[R]t, \end{aligned} \quad (2)$$

where *k* and *t* denote the reaction rate constant for the proton transfer reaction and the reaction time, in the drift tube, respectively. The reaction time *t* in the order of 10<sup>-4</sup> s, which hydronium ions take to traverse the length of the drift tube, is calculated from the given length of the drift tube and drift velocity of H<sub>3</sub>O<sup>+</sup> ions. The reaction rate constant *k* is reported in the order of 2 × 10<sup>-9</sup> cm<sup>3</sup>/s for most VOCs. The ion count rates i(H<sub>3</sub>O<sup>+</sup>) and i(RH<sup>+</sup>), which are proportional to the respective concentrations of these species, are selectively measured by means of a quadrupole mass spectrometer equipped with an ion counting system, which is part of the PTR-MS. Taking the instrument constants and the unit system conversion into account, [R] expressed

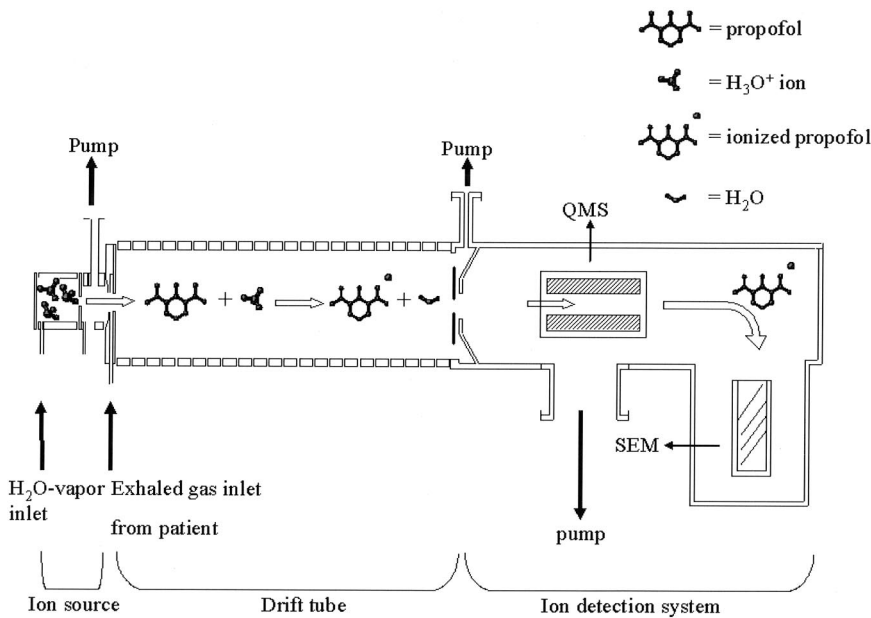

Fig. 6. Schematic representation of the principle of the proton transfer reaction mass spectrometry system. The  $\text{H}_3\text{O}^+$  ions generated in the ion source portion react with the target substance (propofol) in the drift tube (proton transfer reaction). Protonated propofol is then detected with a quadrupole mass spectrometer (QMS) and scanning electron microscope (SEM).

in ppb is derived from equation 3 as follows:

$$[\text{R}] = F \cdot i(\text{RH}^+) / i(\text{H}_3\text{O}^+), \quad (3)$$

where  $F$  is the overall conversion factor including the above-mentioned parameters  $k$  and  $t$ , ion transmission efficiencies of the quadrupole mass spectrometer for  $\text{RH}^+$  and  $\text{H}_3\text{O}^+$ , the conversion factor from the unit of molecules/cm<sup>3</sup> to the unit of ppb at the pressure and temperature of the drift tube, the fragment ratio for  $\text{RH}^+$  if a collision-induced dissociation occurs, and the possible collection efficiency of the sample inlet system. As a result,  $[\text{R}]$  is simply proportional to  $i(\text{RH}^+) / i(\text{H}_3\text{O}^+)$ , which is significant because the linearity of the measurement is ensured as far as the assumption of pseudo-first-order reaction is applied. The important feature of a PTR-MS is that some of the instrument constants for defining the performance of the instrument are always monitored by the measurement of  $i(\text{H}_3\text{O}^+)$ . Once  $k$  is measured or known and other relevant information is obtained, the factor  $F$  and then  $[\text{R}]$  may be calculated theoretically, which suggests that semiabsolute quantification can be achieved at least. In the case of propofol,  $i(\text{RH}^+)$  was measured at 179  $m/z$ . In the measurements,  $i(\text{H}_3\text{O}^+)$  was in the order of 106–107 counts/s, whereas  $i(\text{RH}^+)$  was lower than 103

counts/s. The consumption of  $\text{H}_3\text{O}^+$  ions in the presence of propofol in exhaled air was negligible. Therefore, the validity of equation 3 for propofol was ensured. A reliable  $k$  value for propofol has not been reported in the literature. Therefore, we used the preliminary calibration under the same operating conditions to obtain the  $F$  value. Standard gas samples of propofol in concentrations ranging from 0.40 to 400 ppb were prepared by complete vaporization of a small aliquot of propofol reagent (Sigma-Aldrich Co., St. Louis, MO; assay 97%) and by dilution with synthetic air of the same composition as exhaled air. By plotting the prepared concentration of propofol against the measured  $i(\text{RH}^+) / i(\text{H}_3\text{O}^+)$ , the constant  $F$  in the original equation 3 was determined from the slope of the plotted calibration curve, which had a good linear relation and of which the intercept was almost zero. Therefore, the concentration of exhaled propofol was calculated from equation 3 with the measured  $i(\text{RH}^+) / i(\text{H}_3\text{O}^+)$  and the experimentally determined  $F$  obtained by the above-mentioned calibration procedure. The uncertainty of the propofol concentration was estimated to be approximately  $\pm 30\%$ , mostly because of the uncertainty of the prepared concentration for the standard gas calibration, which was  $\pm 20\%$  because of the difficulty of preparing the gas from the liquid.