

# Physical and Temporal Scaling Considerations in a Robot Model of Cricket Calling Song Preference

Henrik Hautop Lund\*

The Danish National Centre  
for IT-Research

University of Aarhus, Ny  
Munkegade Bldg. 540

8000 Aarhus C.

Denmark

hhl@daimi.aau.dk

<http://www.daimi.aau.dk/~hhl>

Barbara Webb

Department of Psychology

University of Nottingham

Nottingham NG7 2RD

England, UK

Barbara.Webb@nottingham.ac.uk

John Hallam

Department of Artificial

Intelligence

University of Edinburgh

5 Forrest Hill

Edinburgh EH1 2QL

Scotland, UK

john@dai.ed.ac.uk

**Abstract** Behavioral experiments with crickets show that female crickets respond to male calling songs with syllable rates within a certain bandwidth only. We have made a robot model in which we implement a simple neural controller that is less complex than the controllers traditionally hypothesized for cricket phonotaxis and syllable rate preference. The simple controller, which had been successfully used with a slowed and simplified signal, is here demonstrated to function, using songs with identical parameters to those found in real male cricket song, using an analog electronic model of the peripheral auditory morphology of the female cricket as the sensor. We put the robot under the same experimental conditions as the female crickets, and it responds with phonotaxis to calling songs of real male *Gryllus bimaculatus*. Further, the robot only responds to songs with syllable rates within a bandwidth similar to the bandwidth found for crickets. By making polar plots of the heading direction of the robot, we obtain behavioral data that can be used in statistical analyses. These analyses show that there are statistically significant differences between the behavioral responses to calling songs with syllable rates within the bandwidth and calling songs with syllable rates outside the bandwidth. This gives the verification that the simple neural control mechanism (together with morphological auditory matched filtering) can account for the syllable rate preference found in female crickets. With our robot system, we can now systematically explore the mechanisms controlling recognition and choice behavior in the female cricket by experimental replication.

## Keywords

neuroethology, behavioral biology, cricket phonotaxis, robotics, auditory system

## 1 Introduction

Taxis, or approach to a sensory source, is frequently modeled in animat simulations, as a basic behavior of animals in seeking food, mates, or nests. The task is commonly described by the following abstraction: A source produces a signal, the value of which decreases with distance (smoothly or as a step function), and an animat can sense the value and use it to control movement to the source. Braitenberg's [2] "vehicle 2" is an archetypical controller for this task.

\* The first author provided the extended neural model, made the experiments and analysis described in the article, and wrote Sections 3, 4, 5, 6 and parts of 2 and 7. The second author provided the original hypotheses and wrote Sections 1, parts of 2, and 7. The third author designed the auditory circuit.

It is often argued that such simulations model the “essence” of the behavior—as such they should illuminate the understanding of any specific example of the behavior. However, what these abstractions generally ignore are the real physics of signal propagation and detection. The abstract model is a reasonable representation of light, and thus translating simulation results to robot phototaxis is quite often successful. But the model is less adequate for other modalities, many of which are more salient to real animals. For example, in chemotaxis, the properties of the odor plume are critical determinants of the problem [1]. Braitenberg-type control is not appropriate in a task where the signal is highly dispersed (eliminating local gradients) and carried in specific directions by currents in the environment (e.g., around obstacles).

We have argued previously [10] that the common abstraction is positively misleading when applied to the specific example of phonotaxis behavior in crickets. Here the sensors do not respond exclusively to the relevant signal—bursts of sound of a characteristic frequency and repetition rate. However, rather than first filtering for the signal properties and subsequently comparing strength to control turns, the directionality of the sensors and the motor control mechanism are dependent on signal characteristics. For example, a tube connecting the ears transfers a phase-delayed signal from one to the other, thus modifying the negligible amplitude difference between the sensors of this small animal in a noisy environment. Thus we can only understand this system through consideration of the physical properties of the task and agent, which we believe are best investigated through building a physical model.

The same considerations suggest that the physical and temporal scales of the model are likely to be influential in the success of certain controllers for the behavior. Our original implementation of a robot model (a LEGO robot prototype) of the cricket suffered from a number of limitations in this regard, particularly in that the processing of sound was relatively slow compared to the speed of movement [10]. While this model nevertheless sufficed to demonstrate the viability of basic mechanisms, it was difficult to make strong comparisons with data from the animal.

These limitations, and details of the construction of a new robot addressing them, have been described in detail in [5]. We showed there that the reimplemention enabled us to verify experimentally assumptions that had been made, but not tested, about how the cricket responds selectively to carrier frequency of the signal. Here we report how the new robot led us to a revised model of neural control of phonotaxis. Our aim was to reproduce the band-pass selectivity for repetition rate in the signal, using temporal scales identical to those used in cricket experiments.

## 2 Neural Model

The original neural model was based on two properties of identified interneurons (AN1) known to be involved in phonotaxis in the cricket [8]. First, the long time constant of these neurons means that they act as low-pass filters for the temporal pattern of the signal: Given repeated inputs they can only code distinct syllables (bursts of sound) below a certain repetition rate (for calling song structure, see Figure 1). Second, the latency to onset of firing for each syllable is dependent on the amplitude of the sound. Thus which side fires first can be used to generate a turn toward the sound. However, this mechanism has two features: It will not work when syllables repeat too fast for the low-pass filtering to track the onsets; and if the syllables repeat slowly, signals to turn will come less often. Thus there should be a band of repetition rates for which this mechanism works best.

We were able to demonstrate an effective “preference” for certain syllable rates using this mechanism in the LEGO robot. However, this depended partly on the fact that the LEGO robot could move a significant distance between slow syllables, which because

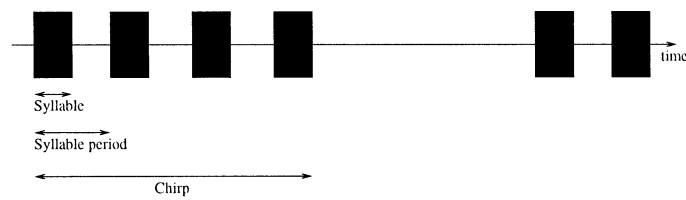

Figure 1. The song structure of the cricket calling song. The calling song consists of chirps, each with a number of syllables (bursts of sound with the species-specific carrier frequency). In this case, with equal syllable length and gap length, the syllable duty-cycle (within a chirp) is 50%.

of the auditory processing speed lasted a second or more in the LEGO robot. Real cricket song has repetition rates in the order of 30 Hz, and “slow syllables” to which they no longer respond may last only 50 ms. With the new robot able to process song at comparable rates to the cricket, slowing the song to 10 Hz or less was not sufficient to interfere with taxis because it was still making 10 corrections a second, which was quite adequate to get it to the sound source. Consequently we had to produce a more complex neural control model than the one suggested in [10] and used to show the robot’s phonotaxis to male *Gryllus bimaculatus* calling song in [5]. In particular, it has been extended to include an extra neuron on each side that performs integration over syllables. This simple neural system can account for much of the biological data that show a band-pass in crickets’ phonotaxis to calling songs with different syllable rates.

The structure of the extended neural model is as follows: Input from the auditory sensors is fed into a neuron on each side (N1); activation can flow from N1 to another neuron (N2), which in turn feeds activation directly to the motor on that side. The activation within a neuron is modeled with a leaky integrator specific for that neuron, so that the activation,  $A$ , at time  $t$  is calculated as

$$A(t) = \alpha * A(t - 1) + I(t), \quad 0 < \alpha < 1, \quad \text{if } A(t) > T_{\text{high}}, A(t) = T_{\text{high}}$$

where  $I$  is the input to that neuron and  $\alpha$  is the decay rate. When  $A(t)$  reaches the upper threshold  $T_{\text{high}}$ , it will “fire,” that is, pass activation on within the network. A neuron that has produced an activation pulse cannot produce another pulse until its activation has first decayed below a lower threshold  $T_{\text{low}}$ . Thus a pulse represents an activation onset, that is, an increase of activation from below  $T_{\text{low}}$  to above  $T_{\text{high}}$ , but not continued activation. The decay rates and thresholds of the neurons can be varied to produce particular kinds of temporal responsiveness.

Figures 2 and 3 show how the N1 and N2 neurons interact. Figure 2 shows the temporal response of neurons on the side receiving the strongest input, during three chirps of three syllables. Each syllable activates N1 above  $T_{1\text{high}}$ , and each gap between syllables allows N1 to decay below  $T_{1\text{low}}$ . Thus N1 will produce one pulse per syllable as input to N2. A single pulse is not sufficient to make N2 reach  $T_{2\text{high}}$ , but because the decay is slow, successive pulses at a sufficiently high rate will result in N2 reaching threshold: in this case after three syllables or the length of the chirp. It can be seen that N1 will act as a low-pass filter (responding only if the gaps between syllables are large enough) and N2 as a high-pass filter (responding only if the syllables occur fast enough).

The summation time to threshold in N1 will depend on the strength of the input signal. The left N1 passes activation to the left N2 only if it reaches threshold before the right N1, and vice versa. This means that the output of N2 indicates a louder signal,

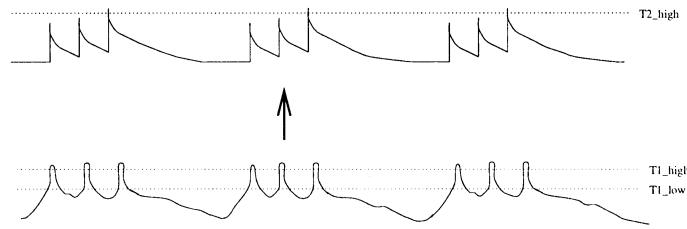

Figure 2. The neural model implemented in the robot. The figure shows the neural activation of neuron N1 at the bottom and of neuron N2 at the top over the same time scale. Three chirps each with three syllables is imagined as input to neuron N1.

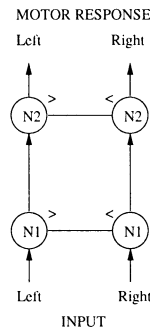

Figure 3. The structure of the neural control mechanism. Activation from the ears is fed into N1. If N1 activation on either left or right reaches  $T1_{high}$ , it is compared with the activation on the contralateral side. If it is higher, the neuron will fire activation on to N2 on the same side. N2 neurons work in a similar way.

of the right temporal pattern, and thus it can be used directly to produce a turn in the correct direction.

The neural model suggested here is somewhat similar to the one suggested by Schildberger [7], who found low-pass and high-pass neurons in neurophysiological experiments with *Gryllus bimaculatus*. Based on this, Schildberger suggested a neural model with low-pass and high-pass neurons that process in parallel and then is ANDed together to produce the band-pass filtering observed in behavioral experiments (see Figure 4). However, the model suggested here is simpler because it directly produces the motor behavior, and not only recognition of the right syllable rate.

### 3 Robot Implementation

The female cricket has four auditory openings: an ear (tympanum) located on each upper foreleg, and an auditory spiracle (or hole) on each side of the frontal section of her body. The four are linked internally by means of tracheal tubes. Sound reaches the tympani directly through the air and, after propagation through the internal tubes, from the other auditory openings. The sound transduced from each tympanum by the cricket's auditory receptors is thus a combination of delayed and filtered signals from the other tympanum and the spiracles arriving at the back of the tympanum with the direct sound arriving at its outer face.

The delays and filtering performed by the auditory morphology improve the cricket's ability to discriminate the arrival direction of the conspecific song because the phased combination of sounds from the different sources induces a strong directional sensitivity

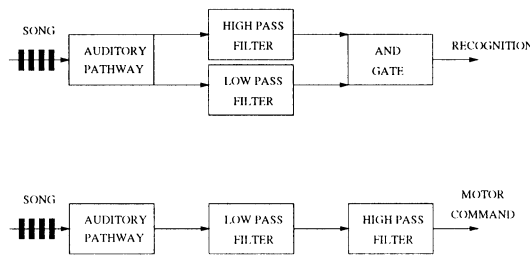

Figure 4. Top: Diagram of Schildberger's [7] hypothesized mechanism for recognition of syllable rates. Bottom: Diagram of our hypothesized mechanism for both recognition and motor response for syllable rates in the right band-width.

into the response of each tympanum. Essentially, sounds arriving from the same side as the tympanum are delayed by the internal structures to arrive in antiphase with respect to the direct path at the ipsilateral ear and in phase at the contralateral ear. Because the sounds arriving by the two paths are subtracted (being on opposite sides of the tympanum), the stimulus intensity at the ipsilateral ear is enhanced while at the contralateral ear it is diminished.

In the cricket, the delays and filter characteristics of the internal auditory structures are species-specific. To model the auditory morphology of the cricket, we have built an electronic emulation of some of these characteristics (see Figures 5 and 6). Sound is collected by two or four microphones whose spacing is carefully controlled. In the present experiments, we use only two microphones to approximate the signal contributions from the two sides of the cricket. The reason for not summing from the opposite tympanum was to emulate biological findings that show that the opposite tympanum makes a negligible contribution to the sum. After amplification and initial filtering three delayed copies of the sound are generated with programmable relative delays, which are then scaled and added together to construct a tympanal response. The intensity of the resultant signal is transduced using an analogue-to-digital conversion system for use by the control program. This hardware allows us to approximate the auditory morphology of various crickets by adjusting the programmable delays and the summing gains. It is not a perfect emulation of the insect, however: Two programmed delays allow us to sum signals from each tympanum and both spiracles, but not from all auditory openings; and the summation system allows us to program relative gains, but not frequency dependent gains.

#### 4 Phonotaxis Experiments

In [5], we used the robot with the auditory system described above to verify that the simple neural control mechanism could account for frequency selectivity, because the robot did phonotaxis to male cricket *Gryllus bimaculatus* calling song and preferred calling songs with the right carrier frequency. Here, we will first replicate some of these experiments with the extended model and then go on to the syllable rate experiments.

In the present experiments, for N1 neurons, the decay rate,  $\alpha_1$ , is set to  $7/8$ , upper threshold,  $T_{1\text{high}}$ , to 900, and lower threshold,  $T_{1\text{low}}$ , to 600. For N2 neurons, the decay rate,  $\alpha_2$ , is set to  $63/64$ , upper threshold,  $T_{2\text{high}}$ , to 1,725. These are empirical settings.

The robot has its auditory sensory system's parameters set as in [5] (i.e., the two microphones are placed 18 mm apart because 18 mm corresponds to one-quarter wave-

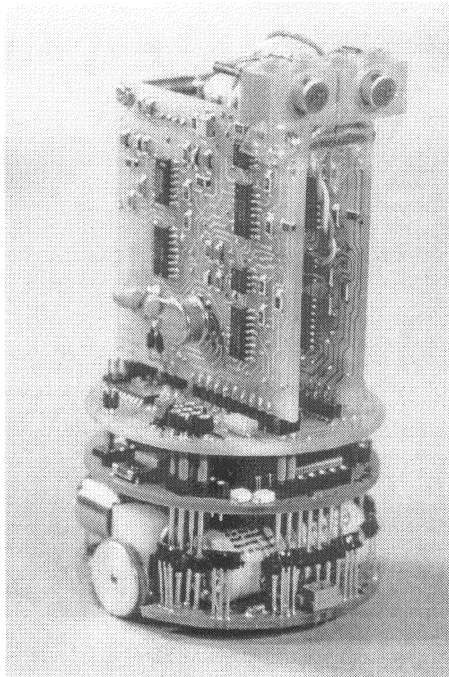

Figure 5. The Khepera robot with the auditory sensors. © Lund, Hallam, & Webb, 1997.

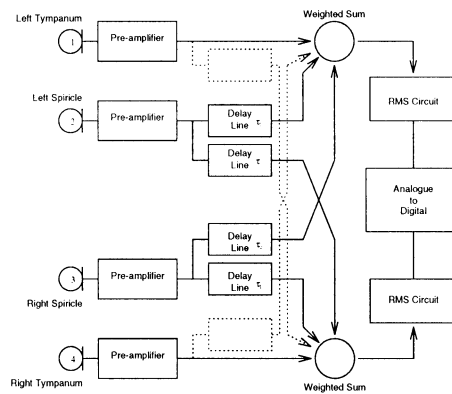

Figure 6. Simplified diagram of the ears circuit. When sound arrives at each microphone (the analogue of the cricket's tympanum), the received signal is preamplified. The signal is then sent with a "through delay" to the mixer at the same side, and with a "cross delay" to the mixer at the opposite side. The mixed signal is sent through a root-mean-square (RMS) to derive a measure of the average energy in the mixed signal, and an A/D converter to one of the Khepera's input channels. The same happens on the opposite side. © Lund, Hallam, & Webb, 1997.

length of the carrier frequency, 4.7 kHz, of male *Gryllus bimaculatus* calling song; the delays are set to 53  $\mu$ s (one-quarter of the period of 4.7 kHz); and the mixers subtract the delayed signal from the contralateral side from the signal from the lateral side). The cycle time of the controller is approximately 1.3 ms. When we play male *Gryllus bimaculatus* calling song to the robot, the empirical settings of neural activation decay and thresholds described above result in the neural effect shown in Figure 2.

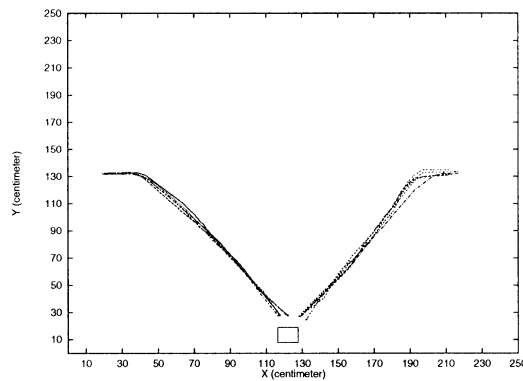

Figure 7. The robot's behavior when male cricket *Gryllus bimaculatus* calling song is emitted from the loudspeaker at the bottom of the arena.

We have replicated the data from [5] with the extended neural model. The results are shown in Figure 7. It shows that the robot with the extended neural models performs phonotaxis to male cricket *Gryllus bimaculatus* calling song<sup>1</sup> emitted from a loudspeaker in the arena. The figure shows 10 different runs with the robot's starting point alternating between 45 degrees left or right to the sound source. Both starting points are 150 cm away from the sound source. In all cases, the robot moves forward a bit, then it reacts to the calling song by turning toward the loudspeaker and moves directly toward it.

Hence, the robot with this neural model is attracted to male *Gryllus bimaculatus* calling song. As was the case with the robot with the previous neural model, this robot also discriminates between calling songs with the right carrier frequency (4.7 kHz) and those with other carrier frequencies (e.g., 6.7 kHz). (The data is not shown here because of space limitation and emphasis on syllable rate preference. For frequency selectivity, see [5].

## 5 Syllable Rate Experiments

Syllable rate experiments with crickets have shown that the female cricket responds only to calling songs with syllable rates within a certain band-pass. Weber and Thorson [12] report that *Gryllus campestris* females to “tracking almost perfectly near 30 syllables per second but [are] revealing reduced performance or [are] stopping entirely at rates below 20Hz or above 40Hz” (p. 321). These data were found using trills, that is, songs with no chirp structure but a continuous syllable and pause pattern (for instance, 50% syllable and 50% pause). However, Weber and Thorson [12] also report that in performance tests for chirps with different syllable numbers, “we have uniformly found that the females' response increases as the number of syllables increases, as long as syllables are delivered at the natural (30-Hz) rate” (p. 318). Doherty [3] also found that *Gryllus bimaculatus* failed to discriminate between calling songs having a 45 ms

<sup>1</sup> The calling song was recorded at the life science department, University of Nottingham. The adult male cricket was sitting in a sand-floored arena and was recorded using a Maplin unidirectional dynamic microphone (YU-34) on a Marantz stereo cassette recorder (CP230) from a distance of about 20 cm. A 30 s part of these recordings is played through a host Pentium computer with SB AWE32 sound card and was repeated twice for each experiment. The sound was fed through an amplifier to a loudspeaker that was placed on a 240 \* 240 cm arena in our robot lab. It should be noted that we did nothing to control echos from the surrounding environment.

syllable period and an alternative syllable period until the alternative syllable period was 30 ms or shorter, or 55 ms or longer.

Though Popov and Shuvalov's [6] arena experiments suggest that *Gryllus campestris* are more attracted by the four-syllable calling song than those with three or five or more syllables, other experiments [4, 12] show that chirps can be dispensed with entirely and females can "track continuous trills of syllables delivered at rates near 30Hz. Our recent tests indicate that this ability increases with the age of the animal" ([12], p. 318). Regarding the change over age, Stout and McGhee [9] also conclude that adult female *A. domestica* were more attracted to calling songs with a much wider range of syllable periods than were attractive to younger females, and thus "for *A. domestica* females, a central filter for SP [syllable period] would at least need a variable band-pass width that could be influenced by other stimuli, age, and other variables" (p. 287).

In the following experiments, we will show how the simple neural model suggested above together with the auditory mechanism implemented in the auditory sensor circuit can account for this data on cricket band-pass filtering of syllable rates. Further, the band-width is dependent only on the characteristics of the N1 and N2 neurons (namely the decay rate and the firing threshold) that might change over age in natural nervous systems.

We made computer-generated trills of a carrier frequency of 4.7 kHz (the carrier frequency of the *Gryllus bimaculatus* calling song) with different syllable rates. The trills had syllable periods of 10, 20, 30, 40, 50, 60, 70, and 80 ms. The total sound energy was kept constant (with a 50% duty cycle, i.e., the syllables were 50% of the syllable period).

As in the previous experiment, we replicated each experiment 10 times by placing the robot at the two starting positions 5 times each (alternating between them). Figure 8 shows the result of these experiments. When the robot was presented with the 10 ms syllable period trill, it did not react at all but just moved with the default forward movement. With the 20 ms syllable period trill, the robot would react very few times and would not perform successful phonotaxis. However, with 30, 40, and 50 ms syllable period trills, the robot performed phonotaxis by reacting to the trill and moving to the source. With 60 ms syllable period trills, the robot reacted to the trill very few times and managed to reach the sound source only once in the 10 runs. With neither 70 ms nor 80 ms syllable period trills did the robot react to the sound at all. Hence, the simple neural model provides an effective syllable rate band-pass filter that allowed the robot to perform phonotaxis only with a narrow band-pass. In this case, the neural band-pass filtering was such that the robot could not perform successful phonotaxis below a syllable period of 30 ms or above 50 ms.

## 6 Statistical Analyses

To analyze the trajectories of the robot and whether there are statistically significant differences between performances under the different experimental setups, we plot the robot's heading in polar coordinates with the origin at the loudspeaker position. Approximately each 0.3 s, we record the robot's position and find the vector connecting the previous position of the robot with its present position. This vector is then plotted in the polar plot using the line from the previous position to the origin (at the loudspeaker) as the polar reference direction. Thus if the robot heads directly toward the speaker, its movement is plotted with zero angle. If the speaker direction is to the right of the robot's heading, the polar plot shows a positive angle, and so on.

After one run, the "vector mean" of the polar plot vectors is calculated; its direction is that of the sum of the plotted vectors, but its length is the length of the direct path from the robot's starting point to the loudspeaker divided by the length of the vector



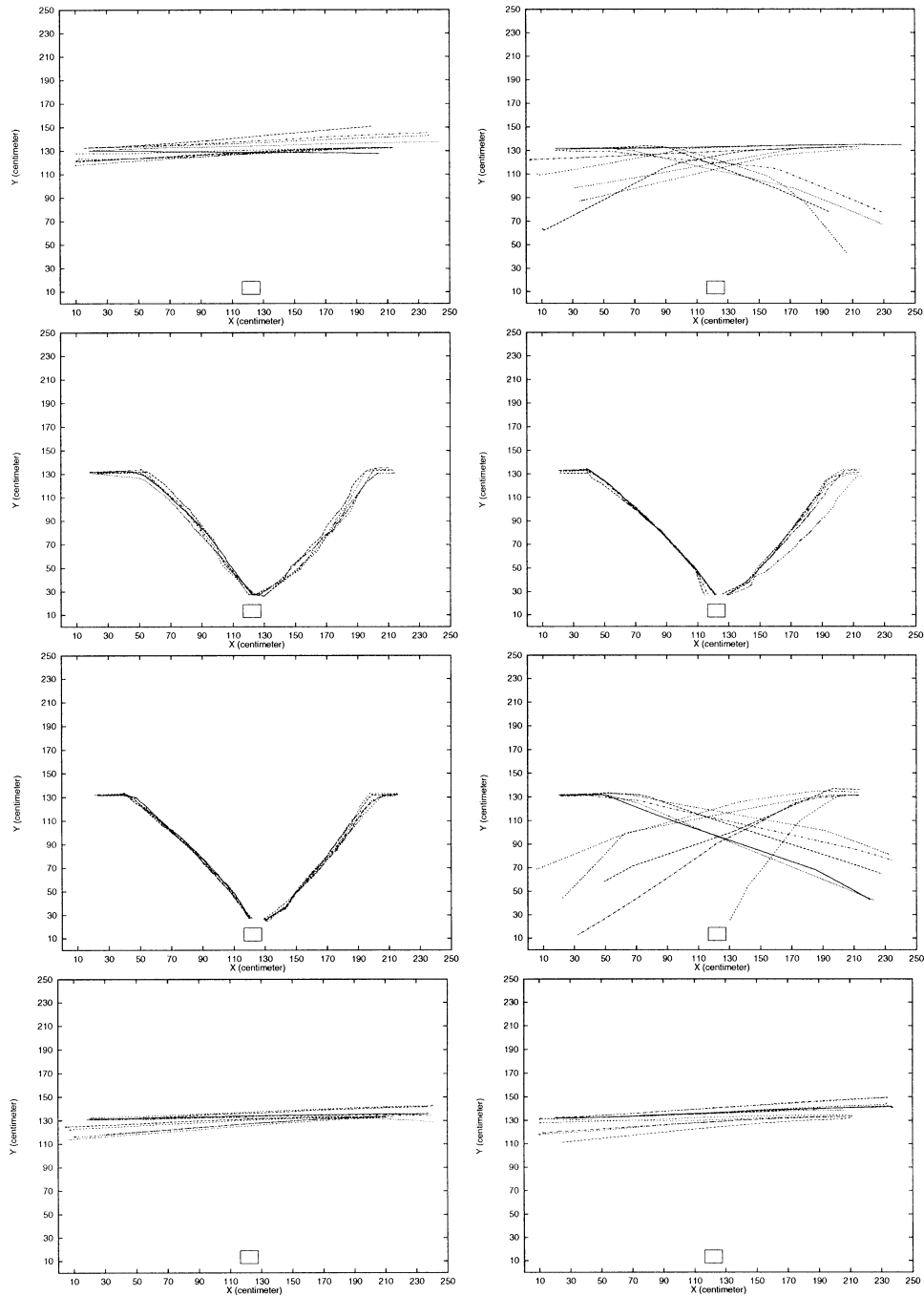

Figure 8. The robot's behavior when trills are emitted from the loudspeaker at the bottom of the arena. The duty cycle is 50% in all experiments, while the syllable rate changes. The experiments are with syllable intervals of 10, 20, 30, 40, 50, 60, 70, and 80 ms (ordered left to right from top to bottom). © Lund, Hallam, & Webb, 1998).

Table 1. Analysis of difference between mean heading directions in polar coordinates between experiments with computer-generated trills with syllable periods of 10, 20, 30, 40, 50, 60, 70, and 80 ms. S indicates that there is a statistically significant difference (significance level 0.01) between heading directions under the corresponding two conditions. Each experimental setup was repeated 10 times to achieve the mean heading direction. Notably, there is no statistically significant difference within 30–50 ms, and statistically significant difference between 30–50 ms and experiments with syllable periods lying outside this interval.

<i>syllable period</i>	10	20	30	40	50	60	70	80
10			S	S	S	S		
20			S	S	S			
30	S	S				S	S	S
40	S	S				S	S	S
50	S	S				S	S	S
60	S		S	S	S		S	S
70			S	S	S	S		
80			S	S	S	S		

sum. This vector mean summarizes the average heading of the robot with respect to the loudspeaker direction and is plotted on the polar plot as a dot (\*). A direct path from starting position to the loudspeaker would therefore be plotted as (0,1)—the angle would be 0 and the directionality of the path would be 1. Figure 9 shows only 1 of 10 replications of each experimental setup (for space limitation reasons). In each case, the robot is started on the same side of the speaker, which means that in all cases where the robot does not react to the sound source (i.e., 10, 20, 60, 70, and 80 ms), the vectors and mean are around 90 degrees. This is biased by the starting position, so starting the robot to the other side of the speaker resulted in vectors and mean around  $-90$  degrees. For the statistical analyses, the vectors from these experiments were subtracted from zero degrees to obtain similar testing situations.

We can then perform statistical tests on the vector means in the different groups of experiments to achieve statistical evidence of the phonotaxis behavior (discrimination between sounds with different syllable rates). Here, we use the statistical U-test and obtain the table shown in Table 1.

For the experiments with songs with varying syllable rates, the statistical analysis shows that there is a statistically significant difference in the robot's performance between experiments with syllable periods in the interval 30–50 ms and all other syllable periods. This is a verification of the biological data—but here we show it with a much simpler control system than has been hypothesized by most biologists (e.g., Schildberger, personal communication).

## 7 Discussion

We have hypothesized a model for explaining the band-pass filtering found in crickets. The model is an extension of the simpler one with which we previously showed frequency selectivity [5]. The experiments presented here show that the extended model results in a behavior similar to the behavior resulted from the previous model, but most importantly, the syllable rate experiments show that the model results in band-pass filtering similar to that found in biological experiments. The statistical analysis of the heading directions shows that there is a statistical difference in heading direction between the conditions where 30–50 ms syllable rate songs are presented and the conditions with syllable rates outside this interval.

Although we have described this as a neural model, it is more properly a “neuron-

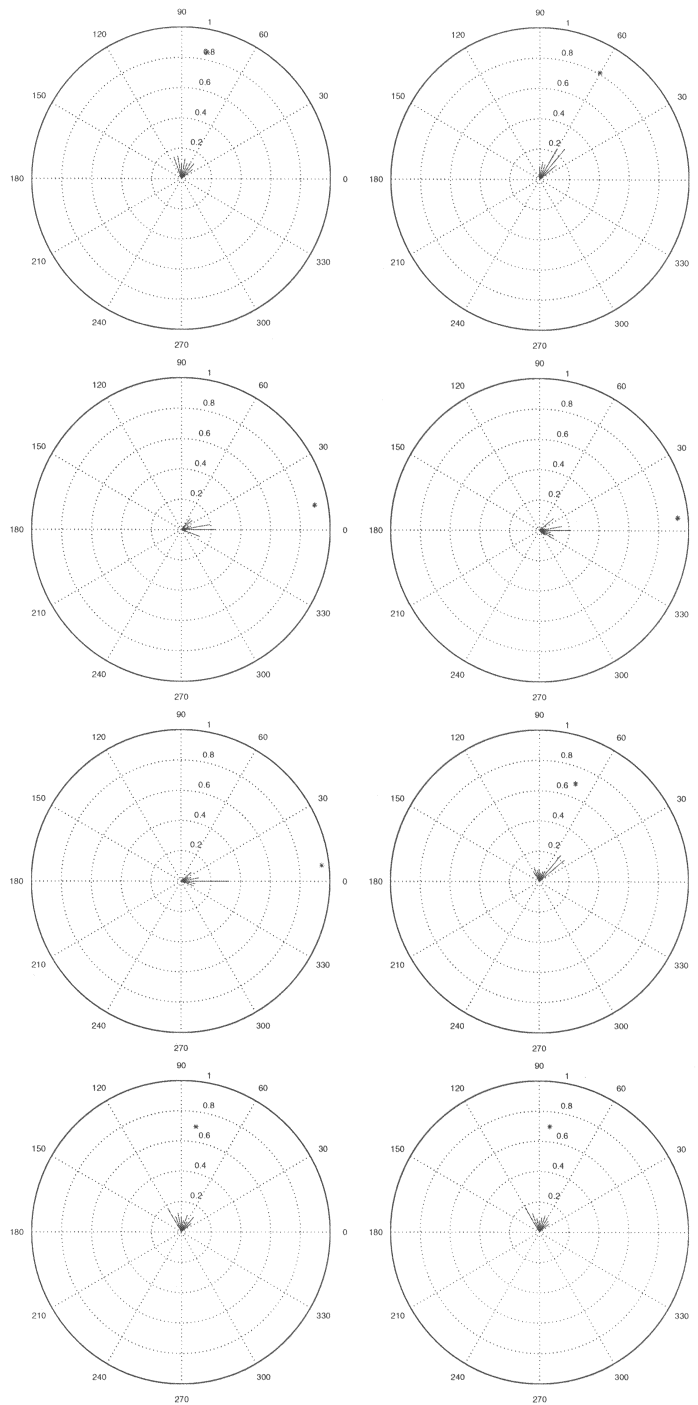

Figure 9. The robot's heading in experiments with songs with different syllable rates. The experiments are with syllable intervals of 10, 20, 30, 40, 50, 60, 70, and 80 ms (ordered left to right from top to bottom). Here, we show data from only 1 of the 10 runs for each syllable rate. © Lund, Hallam, & Webb, 1998.

like” algorithm. N1 and N2 are not intended to correspond explicitly to specific neurons in the cricket but represent processes we believe are carried out by small numbers (3–10) of neurons in the cricket prothoracic ganglion and brain. In [11] we have described how these processes might be mapped onto specific neurons, and we are currently working on implementing the spiking neuron controller described there on the new robot base.

Nevertheless, the way in which our model controls the band-pass response to syllable rates is a plausible “high-level” model of the cricket controller and provides a number of useful insights for interpreting behavioral and physiological cricket research. In particular, it is the simple interactions of decay rates and thresholds in our model that determine the effectiveness of different signals.

The neural band-pass filtering is dependent on the neural characteristics, namely the decay rate and firing thresholds of N1 and N2, and the correspondence between the two. If  $T_{1_{low}}$  is lowered, then the syllable period has to be increased for the N1 activation to drop below  $T_{1_{low}}$  in between syllables, so the robot would respond only to trills with a larger syllable period. If  $T_{1_{low}}$  is set higher, then N1 would be able to fire on trills with a lower syllable period. However, this also depends on the decay rate. On the other hand, N2 allows only trills with a syllable period up to a certain level to pass. If the syllable period is too long, N2 activation will drop too much in between activations from N1 and it will never be able to reach  $T_{2_{high}}$ .

With the decay rates and thresholds set in these experiments, N1 works as a low-pass filter, while N2 works as a high-pass filter of syllable rates.

This also provides a simple method by which the variation in syllable rate preference can be explained. Small parameter changes in decay rates and thresholds can set the preference of the cricket at different values; thus genetic predisposition to species-specific rates can evolve. Adaptation in these parameters during the cricket’s lifetime can explain the age-related change in bandwidth of preference reported elsewhere [9, 12].

A more complex issue is raised by the biological data regarding the syllable duty-cycle: “one can alter the duty cycle... of the values to ca. 90%; the sound remains attractive as long as the syllable repetition rate is near 30Hz” ([12], p. 319). At first glance our model suffices to explain this effect because it is only the onset of syllables that controls behavior, and the length of syllable is irrelevant. In fact the issue is more complex. For a short duty-cycle, our model will produce taxis behavior provided the amplitude of the signal is sufficient to sum to threshold ( $T_{1_{high}}$ ) before the short syllable ends (this depends on details of the summation rate and the value of  $T_{1_{high}}$ ). Consequently it is interesting to note that short syllables do need to be louder to be equally attractive to female crickets. For long duty-cycles our current model is more problematic, because the decay rate and  $T_{1_{low}}$  set a minimum length of gap between syllables. If we increase  $T_{1_{low}}$  to decrease the length of gap required (e.g., for a 90% duty-cycle the gap would be around 5 ms), we also change the low-pass filtering properties such that songs with syllable periods of 10 ms should be easily trackable. We believe this points to an important experiment for cricket neuroethology: No one has (to our knowledge) explored the response of auditory interneurons to long duty-cycle songs. Unless these neurons have a more complex characteristic than low-pass filtering, the ability to track 90% duty-cycle songs is an anomaly. In fact, there is recent evidence on measuring neuron response to different duty-cycles showing that a gap of 5 ms in a 35 ms syllable interval song is not detectable in the firing pattern of AN1 neurons (Tschuluun & Schildberger, personal communication).

Our new robot should enable us to explore a wide variety of other interesting questions in cricket behavior. One is the evolutionarily interesting issue of choice by female crickets between differing males. Our preliminary tests in this area suggest that sen-

sory bias may play a significant role. Another issue is the interaction of taxis with the auditory escape response.

Our exploration of the phonotaxis system has re-emphasised the close relationship of physical and temporal scales with the control systems underlying behavior. A generic simulation approach may tell us little about real problems in approach behavior. By investigating a specific biological system and modeling it at a level of detail driven by biological questions, we gain more sophisticated insights into the real problems of sensorimotor control.

### Acknowledgments

This work was supported by EPSRC grant nr. GR/K 78942 and The Danish National Research Councils. Facilities were provided by the Danish National Centre for IT Research, and the Universities of Edinburgh and Nottingham.

### References

1. Bell, W. J., Kipp, L. R., & Collins, R. D. (1995). The role of chemo-orientation in search behaviour. In R. T. Carde & W. J. Bell (Eds.), *Chemical ecology of insects 2* New York: Chapman and Hall.
2. Braitenberg, V. (1984). *Vehicles: Experiments in synthetic psychology*. Cambridge, MA: MIT Press.
3. Doherty, J. A. (1985). Phonotaxis in the cricket, *Gryllus bimaculatus* degeer: Comparison of choice and no-choice paradigms. *Journal of Comparative Physiology A*, 157, 279–289.
4. Doherty, J. A. (1985). Temperature coupling and trade-off phenomena in the acoustic communication system of the cricket, *Gryllus bimaculatus* degeer (gryllidae). *Journal of Experimental Biology*, 114, 17–35.
5. Lund, H. H., Webb, B., & Hallam, J. (1997). A robot attracted to the cricket species *Gryllus bimaculatus*. In P. Husbands & I. Harvey (Eds.), *Proceedings of the Fourth European Conference on Artificial Life* (pp. 246–255). Cambridge, MA: MIT Press/Bradford Books.
6. Popov, A. V., & Shuvalov, V. F. (1977). Phonotactic behaviour of crickets. *Journal of Comparative Physiology A*, 119, 111–128.
7. Schildberger, K. (1984). Temporal selectivity of identified auditory neurons in cricket brain. *Journal of Comparative Physiology A*, 155, 171–185.
8. Schildberger, K., & Horner, M. (1988). The function of auditory neurons in cricket phonotaxis I. Influence of hyperpolarization of identified neurons on sound localization. *Journal of Comparative Physiology A*, 163, 621–631.
9. Stout, J. F., & McGhee, R. W. (1988). Attractiveness of the male *Acheta domesticus* calling song to females II. The relative importance of syllable period, intensity, and chirp rate. *Journal of Comparative Physiology A*, 164, 277–287.
10. Webb, B. (1995). Using robots to model animals: A cricket test. *Robotics and Autonomous Systems*, 16, 117–134.
11. Webb, B., & Scutt, T. (1997). A simple latency-dependent spiking-neuron model of cricket phonotaxis. Manuscript submitted for publication.
12. Weber, T., & Thorson, J. (1989). Phonotactic behavior of walking crickets. In F. Huber, T. E. Moore, & W. Loher (Eds.), *Cricket behaviour and neurobiology* (pp. 310–339). Ithaca, NY: Cornell University Press.