

# Sensitivity analysis of Xinanjiang rainfall–runoff model parameters: a case study in Lianghui, Zhejiang province, China

Danrong Zhang, Liru Zhang, Yiqing Guan, Xi Chen and Xinfang Chen

## ABSTRACT

The Xinanjiang rainfall–runoff model has been successfully applied in many humid and sub-humid areas in China since 1973. The wide application is due to the simple model structure, the clear physical meaning of the parameters and the well-defined model calibration procedure. However, due to a data scarcity problem and short runoff concentration time, its applications to small drainage basins are difficult. Therefore, we investigate the model application in Lianghui, a small drainage basin of Zhejiang province in China. By using generalized likelihood uncertainty estimation (GLUE) methodology, the sensitivity of parameters of Xinanjiang model was investigated. The data clearly showed that equifinality phenomenon was evident in both water balance parameter calibration and runoff routing parameter calibration procedures. The results showed that  $K$  (evapotranspiration conversion coefficient),  $C_s$  (recession constant in channel system) and  $S_m$  (areal free water storage capacity of surface soil) are the most sensitive parameters for the water balance parameter calibration while  $C_s$ ,  $S_m$  and  $W_m$  (mean area tension water capacity) are the most sensitive parameters for runoff routing parameter calibration. The conclusion is favourable for understanding parameters of Xinanjiang model in order to provide valuable scientific information for simulating hydrological processes in small drainage basins.

**Key words** | equifinality, Lianghui basin, uncertainty, Xinanjiang Model

**Danrong Zhang** (corresponding author)  
**Xi Chen**  
State Key Laboratory of Hydrology-Water  
Resources and Hydraulic Engineering,  
Hohai University,  
Nanjing 210098,  
China  
E-mail: danrong\_zhang@hhu.edu.cn

**Liru Zhang** (corresponding author)  
Nanjing Hydraulic Research Institute,  
Nanjing 210029,  
China  
E-mail: liru\_zhang@nhri.cn

**Danrong Zhang**  
**Yiqing Guan**  
**Xinfang Chen**  
College of Hydrology and Water resources,  
Hohai University,  
Nanjing 210098,  
China

## INTRODUCTION

The Xinanjiang hydrological model, developed in 1973, is a conceptual watershed model that has been used widely and successfully for simulating streamflow in humid and semi-humid areas in China (e.g. Tong 2005; Zhao *et al.* 2007; Jin *et al.* 2008; Li *et al.* 2008). It has been used in many hydrologic projects for the purpose of predicting floods. The model has been applied to assist with water resources estimation, water project programming, hydrological station planning and water quality accounting. The wide application is due to the simple model structure, the clear physical meaning of the parameters and the well-defined model calibration procedure. Xinanjiang's model structure is simple compared to other hydrologic models (Dong *et al.* 2006; Xie *et al.* 2007; Wang *et al.* 2008). All of the parameters have clear physical meanings and

many have already been found to be insensitive given appropriate initial values (Zhao 1984; Zhao & Wang 1988; Zhao 1992).

The Xinanjiang model was applied to some humid and semi-humid basins where the model had not been used before or where new data were available, and was compared with other hydrological models (Guan *et al.* 2006; Ju *et al.* 2009). The model structure is modified in order to apply it to areas where the Xinanjiang model was thought to be unsuitable, e.g. semi-arid areas. The sensitivity of the parameters and the calibration procedure have been re-evaluated and the local and regional empirical ranges of the parameters were derived (Zhang *et al.* 2008). Remote sensing and geographic information systems (GIS) data have been used to improve data input, and digital elevation model (DEM) data

have been utilized to define the boundary of the basin and sub-basin (Li *et al.* 2009).

New automatic calibration methods were introduced (Hapuarachchi *et al.* 2001; Cheng *et al.* 2002; Cheng *et al.* 2006). Real-time prediction and coupled atmospheric-hydrological modelling are also important aspects of the model development (Lin *et al.* 2006). In recent years, the uncertainty of parameter identification and model prediction were also studied but mainly for large river basins (Li & Liang 2006; Su *et al.* 2008).

The performance of a rainfall–runoff model depends heavily on the selection of suitable model parameters. Traditional parameter calibration of a hydrological model aims to find a group of parameters which can best reflect the characteristics of the basin. However, Beven & Binley (1992) found the phenomenon of ‘equifinality’ among parameters groups. In order to deal with the equifinality phenomenon, Beven and Binley proposed the generalized likelihood uncertainty estimation (GLUE) method. In recent years, GLUE has been used in China to investigate the uncertainty of hydrologic models and parameter identification. The GLUE method was applied to the Lushi watershed of Yellow River and the results were helpful for analyzing the parameter uncertainty of a hydrological model (Mo *et al.* 2004). Huang & Xie (2007) used the Xingfeng catchments as an example to study the uncertainty of TOPMODEL (topography model) using the GLUE method.

In this paper, taking Lianghui basin as a case study, the difficulties in the application of the Xinanjiang model to small drainage basins are discussed and the sensitivities of parameters are analyzed. The GLUE method (Beven & Freer 2001) is applied to Lianghui basin to investigate the uncertainty of model parameter identification. The result is favourable for a good understanding of the parameters of the Xinanjiang model, in order to provide valuable scientific information for simulating hydrological processes in small drainage basins.

## XINANJIANG MODEL DESCRIPTION AND CALIBRATION PROCEDURE

The Xinanjiang hydrological model is a conceptual watershed model. The basin is divided into a set of sub-basins;

the outflow hydrograph from each sub-basin is first simulated and then routed down along the channels to the main basin outlet. The schematic diagram of Xinanjiang model is shown in Figure 1 (Zhao 1992).

For the Xinanjiang model, there are 15 parameters for a sub-basin when using the lag and routed method. The 15 parameters may be grouped as follows (Zhao 1992):

1. Evapotranspiration, which consumes the soil moisture storage. The parameters involved in this group are  $K$ ,  $U_m$ ,  $L_m$  and  $C$ .  $K$  is an adjustment coefficient for potential evapotranspiration,  $U_m$  is upper zone tension water capacity,  $L_m$  is lower zone tension water capacity and  $C$  is the coefficient of deep evapotranspiration.
2. Runoff production, which produces the runoff according to the rainfall and soil moisture storage deficit. The parameters involved in this group are  $W_m$ ,  $B$  and  $I_m$ .  $W_m$  is mean area tension water capacity,  $B$  is the exponent of the tension water capacity curve and  $I_m$  is the ratio of impervious area to the total area of the basin.
3. Total runoff separation, which divides the total runoff into three components: surface runoff, subsurface flow and groundwater flow. The parameters involved in this group are  $E_x$ ,  $S_m$ ,  $K_g$  and  $K_i$ .  $E_x$  is the exponent of the free water capacity distribution curve,  $S_m$  is the mean area free water storage capacity of the surface soil layer,  $K_g$  is the daily groundwater coefficient and  $K_i$  is daily interflow coefficient.

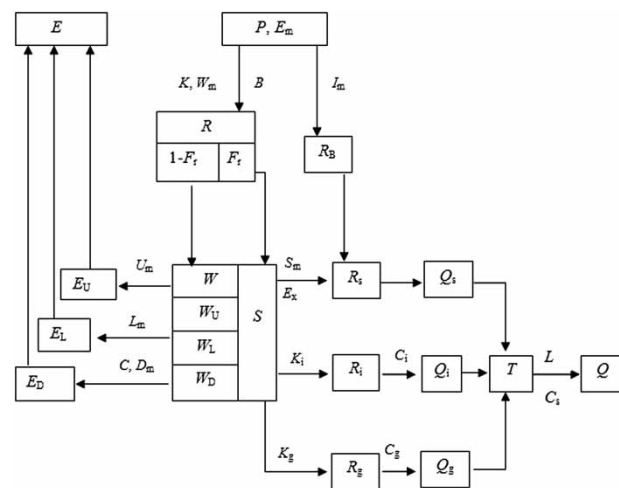

Figure 1 | Structure of the Xinanjiang model (Zhao 1984).

4. Runoff concentration, which transfers the local runoff to the outlet of each sub-basin forming the outflow of the sub-basin. The parameters involved in this group are  $C_g$ ,  $C_s$ ,  $C_i$  and  $L$ .  $C_g$  is the daily groundwater recession coefficient,  $C_s$  is the recession constant in the ‘lag and route’ method for routing through the channel system within each sub-basin;  $C_i$  is the daily interflow recession coefficient and  $L$  is the corresponding ‘lag’.

Parameters of the Xinanjiang model were previously classified into three groups by their computing method and parameter sensitivity. The values of sensitivity parameters such as  $C_s$  can greatly affect the values of  $R^2$ .  $R^2$  is the coefficient of determination; the better the fit between the observed and modelled data, the higher  $R^2$  will be and the more likely the respective parameter set will occur. The  $R^2$  value is commonly used to evaluate model accuracy. The values of non-sensitivity parameters such as  $U_m$  and  $E_x$  have little effect on the values of  $R^2$ ; however, values of regional sensitivity parameters such as  $B$ ,  $W_m$  and  $S_m$  differently affect the values of  $R^2$  in different regions (Zhao et al. 1980; Zhao 1992).

Previous applications of the Xinanjiang model have indicated ranges that are helpful for setting initial values for some of the model parameters. Table 1 lists the empirical ranges of the Xinanjiang model parameters.

**Table 1** | Empirical ranges of Xinanjiang model parameters

Parameter	Range
$K$	0.5–1.1
$I_m$	0–0.1
$W_m$ (mm)	80–170
$U_m$ (mm)	5–20
$L_m$ (mm)	60–90
$C_s$	–
$E_x$	0.5–2.0
$C$	0.08–0.18
$B$	0.1–0.4
$K_g + K_i$	0.7–0.8
$C_g$	0.99–0.998
$C_i$	0.5–0.9
$S_m$ (mm)	10–50

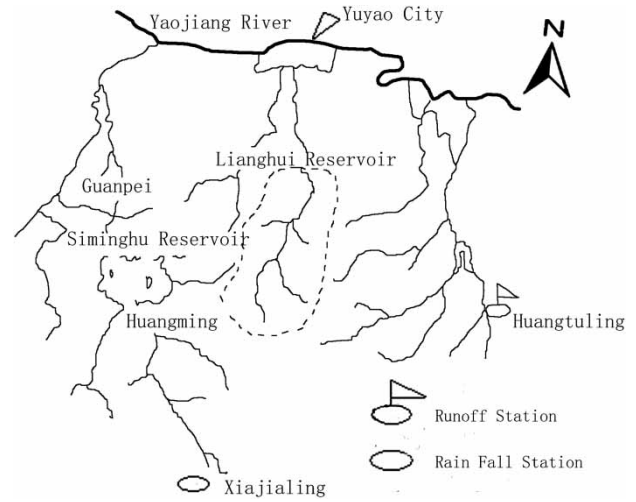

**Figure 2** | Distribution of hydrological stations around LiangHui reservoir.

The calibration procedure involves two steps. During the water balance parameter calibration, some parameters are calibrated with the objective of best fit to the total runoff. The simulation time spans one year to many years, and daily data are needed. During runoff routing parameter calibration, some of the parameters are fixed and others will be calibrated with the objective of best fit to the flood hydrograph. For the second step, only one flood event or several flood events are simulated and the time-

**Table 2** | The calibrated parameter values and ranges used in the water balance parameter calibration

Parameter	Value	Range
$K$	0.916	0–2
$I_m$	0.015	0–0.1
$W_m$ (mm)	120	50–300
$U_m$ (mm)	20	0–50
$L_m$ (mm)	70	0–150
$C_s$	0.7	0–1
$E_x$	1.3	0.6–2.6
$C$	0.15	0–0.5
$B$	0.1	0–1
$K_g$	0.2	0–0.5
$K_i$	0.5	0–0.6
$C_g$	0.8	0.5–1
$C_i$	0.5	0–1
$S_m$ (mm)	30	0–200

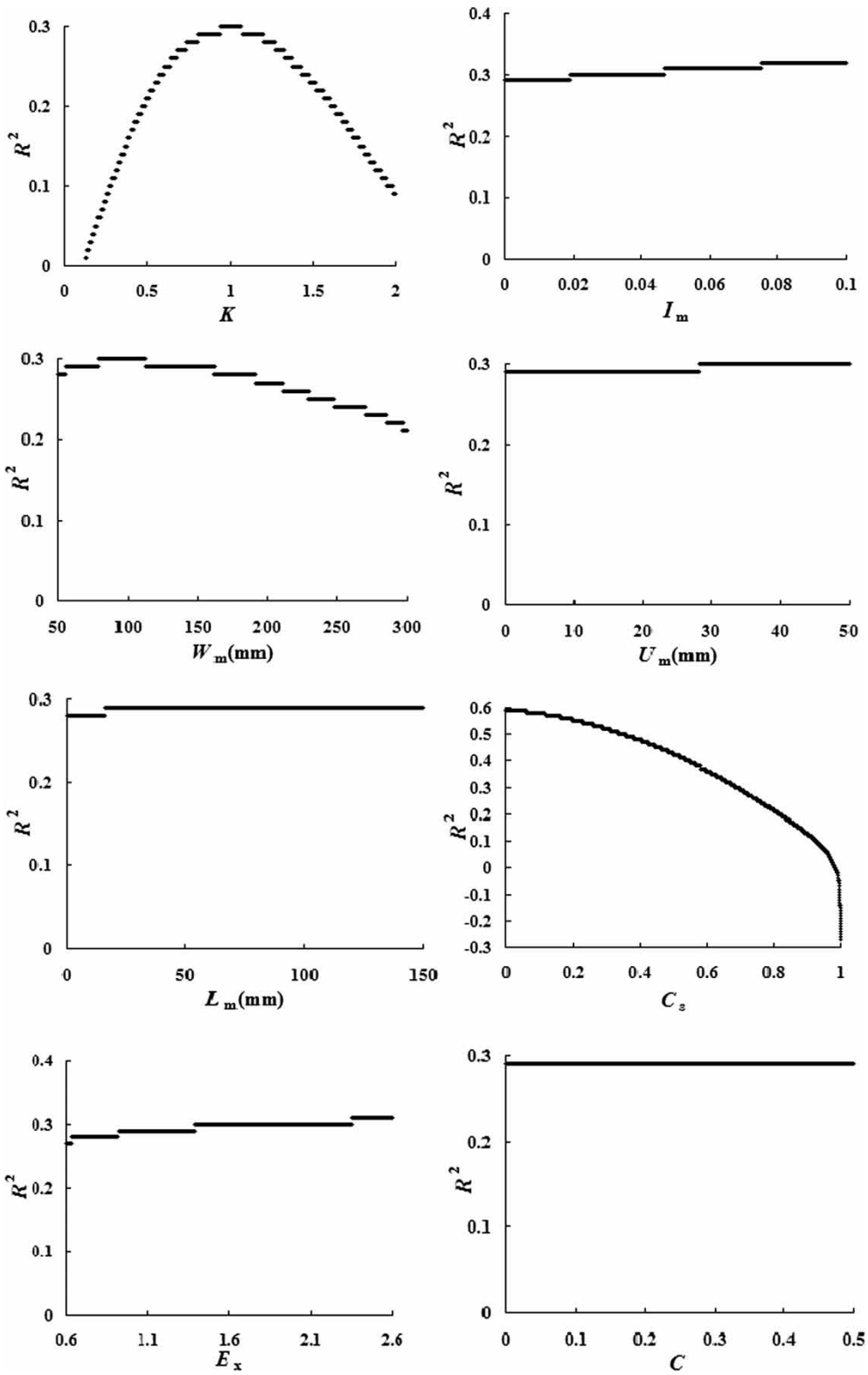

Figure 3 | Sensitivity of Xinanjiang model parameters in water balance parameter calibration (continued).

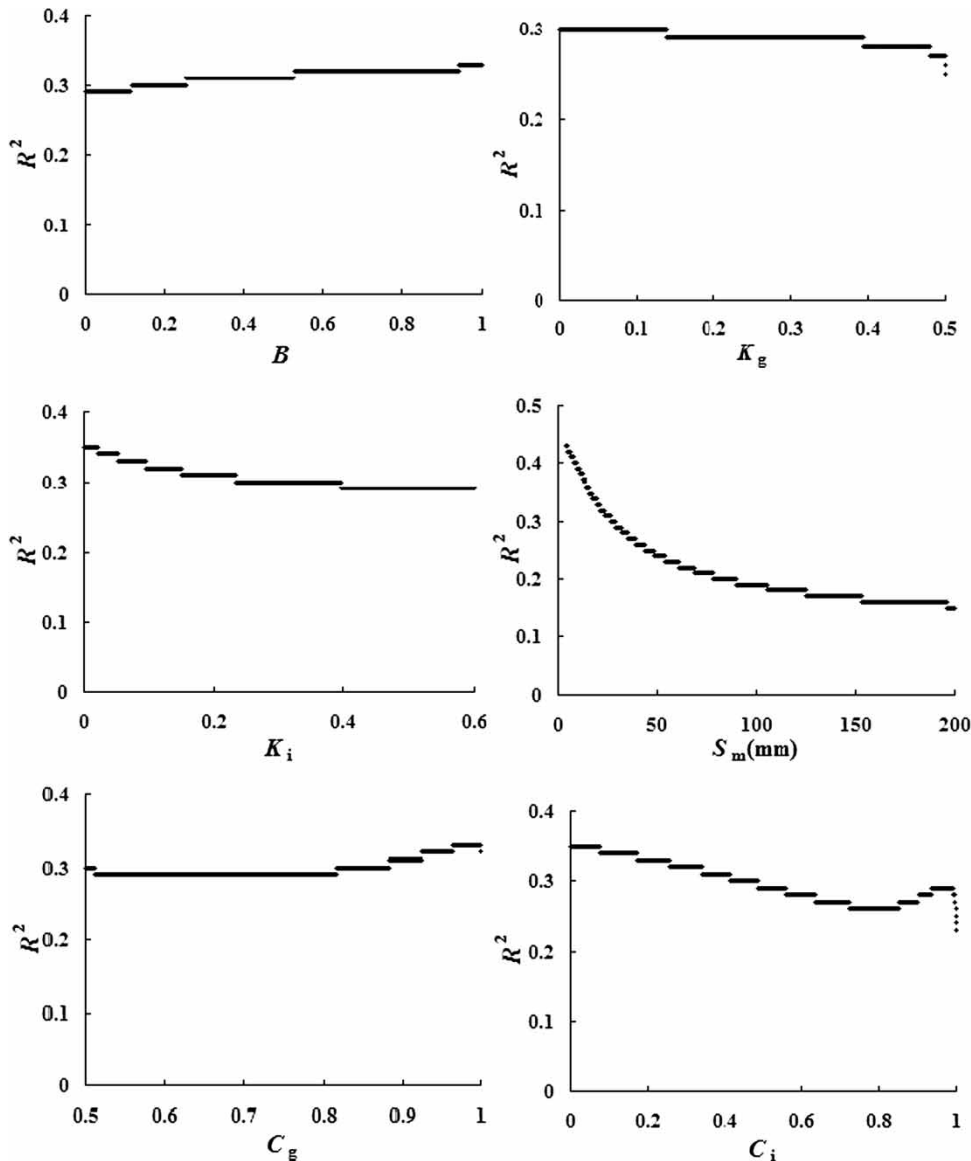

Figure 3 | continued

step is chosen from several minutes to a few hours, according to basin concentration time.

## STUDY SITE

The Xinanjiang rainfall-runoff model was applied in the Lianghai basin during 2002–2006. Lianghai drainage basin is located in Zhejiang province, south-eastern China. The drainage basin is about  $35 \text{ km}^2$  and its main stream length

is 11 km. The Lianghai stream belongs to Yaojiang water system in Yongjiang watershed, located in the subtropical monsoon climate zone with an average annual rainfall of 1,619 mm and average annual runoff of  $3,175 \times 10^4 \text{ m}^3$ . No evaporation or precipitation data are available within the drainage basin. The distribution of nearby hydrological stations around Lianghai is shown in Figure 2.

In this study area, the areal precipitation is calculated by averaging measurements at three neighbouring gauge stations: Guan Pei, Huang Ming and Huang Tuling. There

are no pan evaporation observation data for the period 2002–2006, but the daily pan evaporation observation data from 1980 to 1989 are available for the neighbouring Siminghu reservoir. The mean daily pan evaporation data for 1980–1989 are therefore used as daily evaporation input,  $E_m$ .

## RESULTS AND DISCUSSION

The uncertainty in applying hydrologic models usually comes from the following sources: model data, model structure and model parameters. The data scarcity problem is

usually more severe for some small drainage basins because there might be no precipitation and evaporation observations in the small drainage basins. It is evident that the precipitation and evaporation data scarcity is one of the main sources of uncertainty of the Xinanjiang model application in Lianghui basin.

**Table 3** | The ranges of Xinanjiang model parameters in the water balance parameter calibration used for GLUE

Parameter	$K_g$	$W_m$ (mm)	$C_s$	$K_i$	$C_i$	$S_m$ (mm)
Range	0–2	50–300	0–1	0–0.5	0–1	0–200

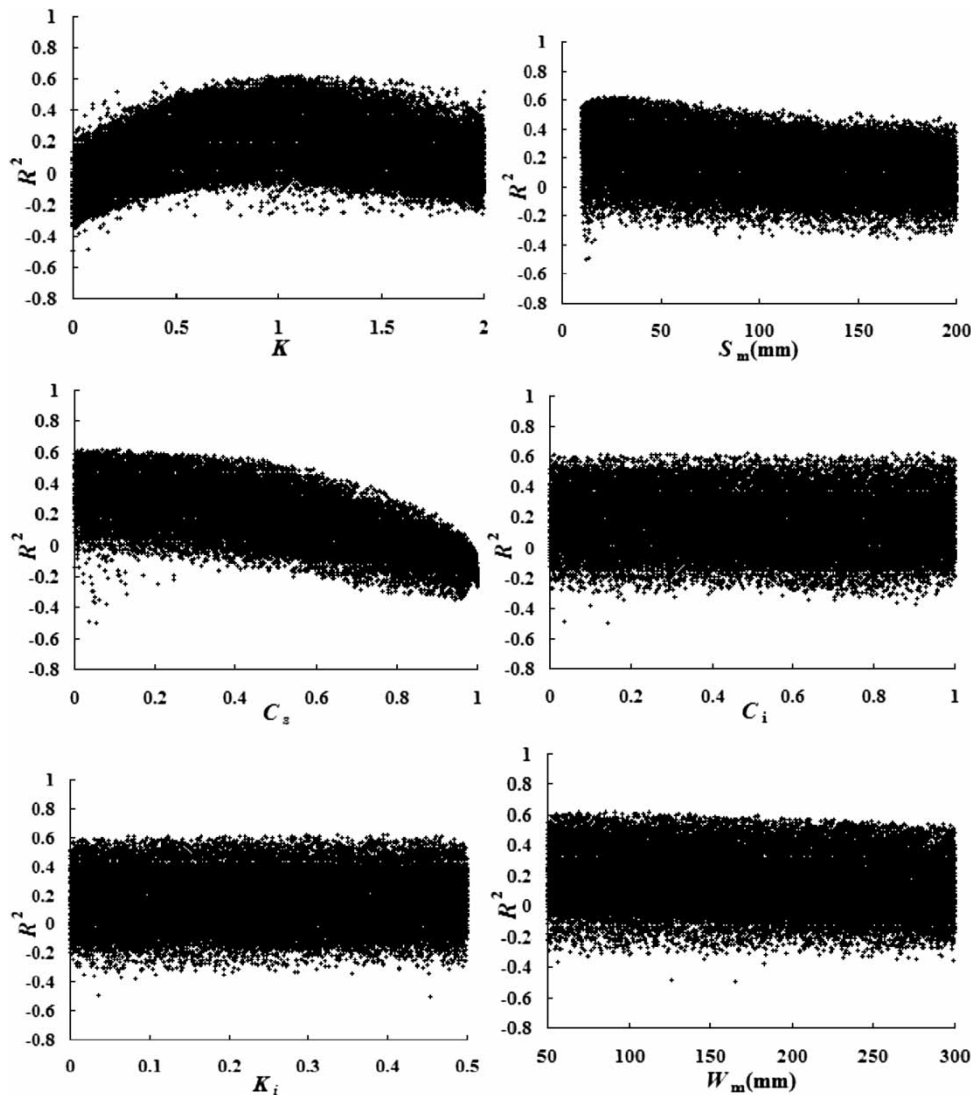

**Figure 4** | Scatter plots of the likelihood of some sensitive Xinanjiang model parameters in water balance parameter calibration.

In the Xinanjiang model, spatial distributions of soil moisture deficit and storage capacity in the catchment are considered as non-uniform, thus the runoff-producing area is also simulated in terms of a non-uniform distribution. The tension water capacity in the sub-basin is represented statistically by an exponential curve in the Xinanjiang model. This factor has been considered to be the reason why the Xinanjiang model performed better than some other models (Gan et al. 1997). However, the Xinanjiang model was originally built for large catchments in humid and semi-humid areas with rich vegetation, a well developed soil zone, low surface runoff and high interflow; the curve may therefore be appropriate for large basins but has not been verified appropriate for small basins. Another weak point of the model is that the sub-areas are divided according to the location of rain gauges; this situation means that only rainfall spatial variability can be considered and the spatial variability of topography and vegetation on the land surface cannot.

During the water balance parameter calibration, all parameters except  $L$  were calibrated firstly by using five years of data from 2002 to 2006. Because of the small size, the lag time  $L$  is set to 0. The parameter set in Table 2 shows the calibrated values obtained using a trial-and-error method with an  $R^2$  value around 0.60, and the ranges of the parameters. Only one parameter value is changed at a time within the range shown (while the other parameter values were fixed) in order to test the sensitivity of each parameter. The coefficient of determination  $R^2$  was used as the objective function to show the sensitivity of the model parameters, as it is a measure of how well the simulated hydrograph fits the measured hydrograph.

As shown in Figure 3, the value of  $R^2$  is more sensitive to parameters  $K$ ,  $C_s$ ,  $S_m$ ,  $K_i$ ,  $W_m$  and  $C_i$ . Other parameters such as  $U_m$  and  $L_m$  have little or no effect on the value of  $R^2$ . In this case study, the six parameters  $K$ ,  $C_s$ ,  $S_m$ ,  $K_i$ ,  $W_m$  and  $C_i$  were changed simultaneously while the others were fixed. According to the GLUE method, the six parameter values were randomly created using a Monte Carlo sampling method within their respective ranges and, with the other nine parameter values, form a parameter set.

A total of 60,000 parameter sets were generated and the runoff was simulated. The range of the six parameters was adopted from Jin et al. (2008) and is listed in Table 3. Figure 4 presents scatter plots of the likelihood of some sensitive

parameters for the water balance parameter calibration. The equifinality phenomenon is evident. Figure 4 shows that the water balance parameter calibration adjustment coefficient is most sensitive to potential evapotranspiration  $K$ , especially within the range 0–1. It is reasonable because yearly evaporation for this area is high and it significantly affects the water balance.

The recession constant  $C_s$  in the ‘lag and route’ method for routing through the channel system within each sub-basin is the second-most sensitive parameter to the water balance parameter calibration, especially in the range 0.6–1. Mean area free water storage capacity of the surface soil layer  $S_m$  is also important, especially within the range 0–50 mm. Compared with the above three parameters, the daily interflow coefficient  $K_i$ , the daily interflow recession coefficient  $C_i$  and the mean area tension water capacity  $W_m$  have only a small effect on the value of  $R^2$ .

The second step is runoff routing parameter calibration. In order to determine which parameters have the greatest affect on the calibration, five flood events were selected from 2002 to 2006 for calibration. Table 4 lists the identified parameter values based on the trial-and-error calibration, which were then used as initial parameter values to analyze the sensitivity. The  $R^2$  values vary from 0.6 to 0.9. The range of each parameter for single parameter sensitivity is given in Table 4. As shown in Figure 5,  $R^2$  is more sensitive to parameters  $C_s$ ,

**Table 4** | The calibrated parameter values and parameter ranges used in the runoff routing parameter calibration

Parameter	Value	Range
$K$	0.995	0–2
$I_m$	0.015	0–0.1
$W_m$ (mm)	120	100–300
$U_m$ (mm)	20	0–50
$L_m$ (mm)	70	0–150
$C_s$	0.7	0–1
$E_x$	1.3	0.5–2.5
$C$	0.15	0–0.5
$B$	0.1	0–1
$K_g$	0.2	0–0.5
$K_i$	0.5	0–0.6
$C_g$	0.8	0.5–1
$C_i$	0.5	0–1
$S_m$ (mm)	30	0–200

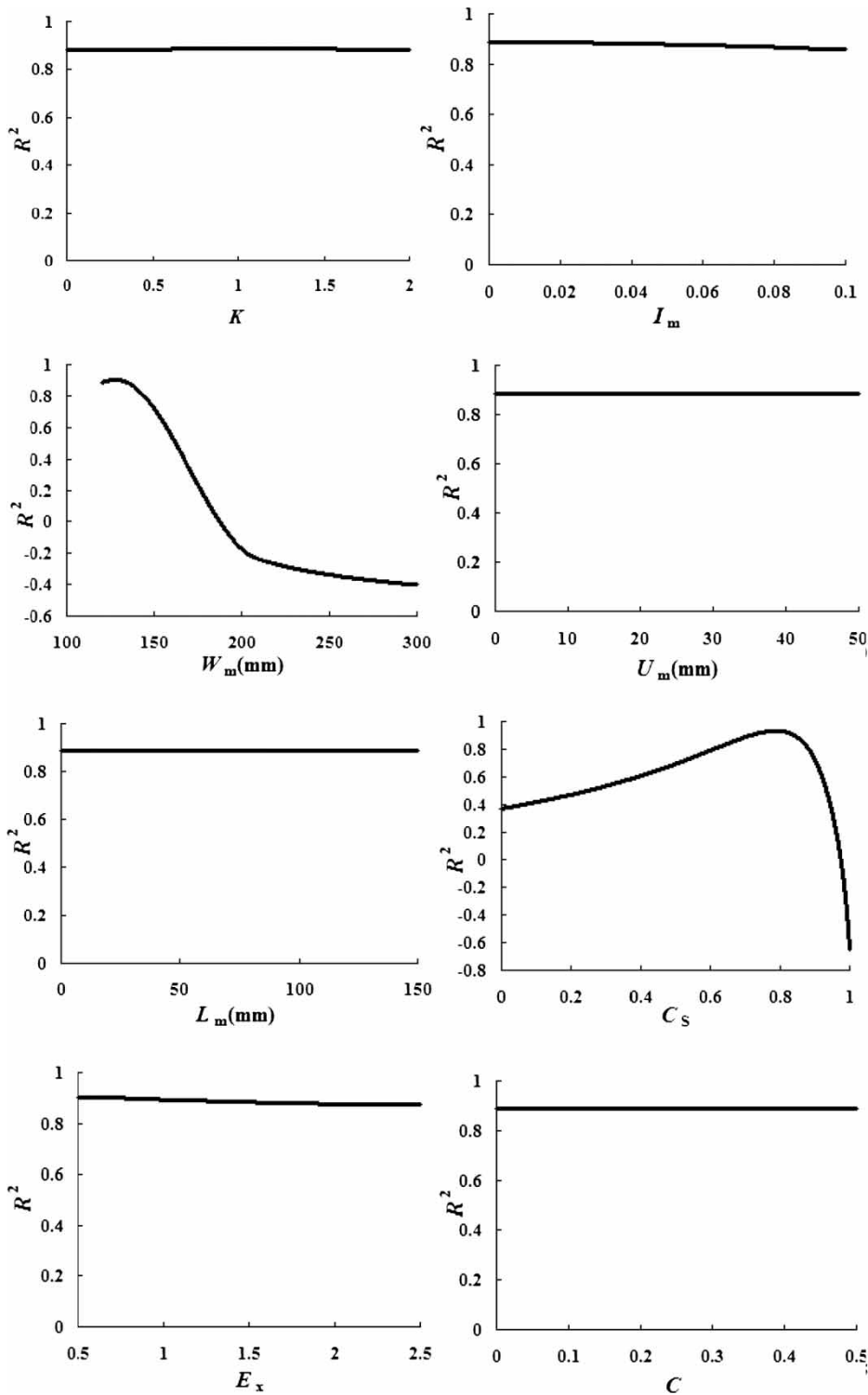

Figure 5 | Sensitivity of Xinanjiang model parameters in runoff routing parameter calibration (continued).



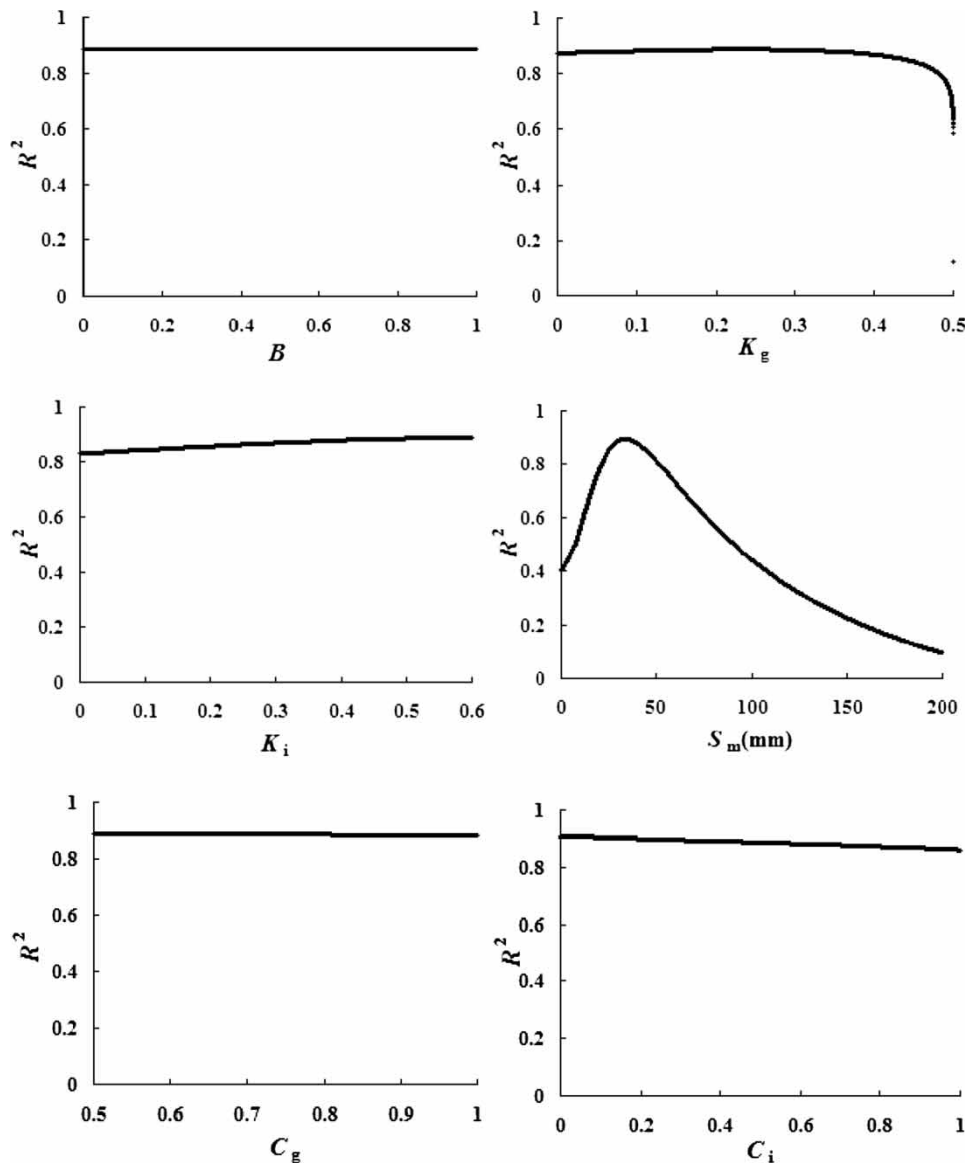

Figure 5 | continued

$S_m$ ,  $K_i$ ,  $K_g$ ,  $C_i$  and  $W_m$  but not to parameters such as  $K$  and  $E_x$ . The flood events were also simulated with 60,000 parameter sets which were randomly created with these six parameters varied within the respective ranges while the others were fixed. Table 5 shows the ranges of the six parameters used for GLUE.

Figure 6 presents scatter plots of the likelihood of some sensitive parameters in runoff routing parameter calibration, showing clearly the relationship between the values of parameter and likelihood. The phenomenon of equifinality is

Table 5 | Ranges of parameters used in the runoff routing parameter calibration for GLUE

Parameter	$K_g$	$W_m$ (mm)	$C_s$	$K_i$	$C_i$	$S_m$ (mm)
Range	0–0.5	120–300	0–1	0–0.5	0–1	0–200

obvious according to the results. As shown in Figure 6, the uncertainty of parameters  $K_g$ ,  $C_i$  and  $K_i$  is more significant than that of parameters  $C_s$ ,  $S_m$  and  $W_m$ .

To illustrate the equifinality phenomenon, three examples of equifinality parameter groups are presented in

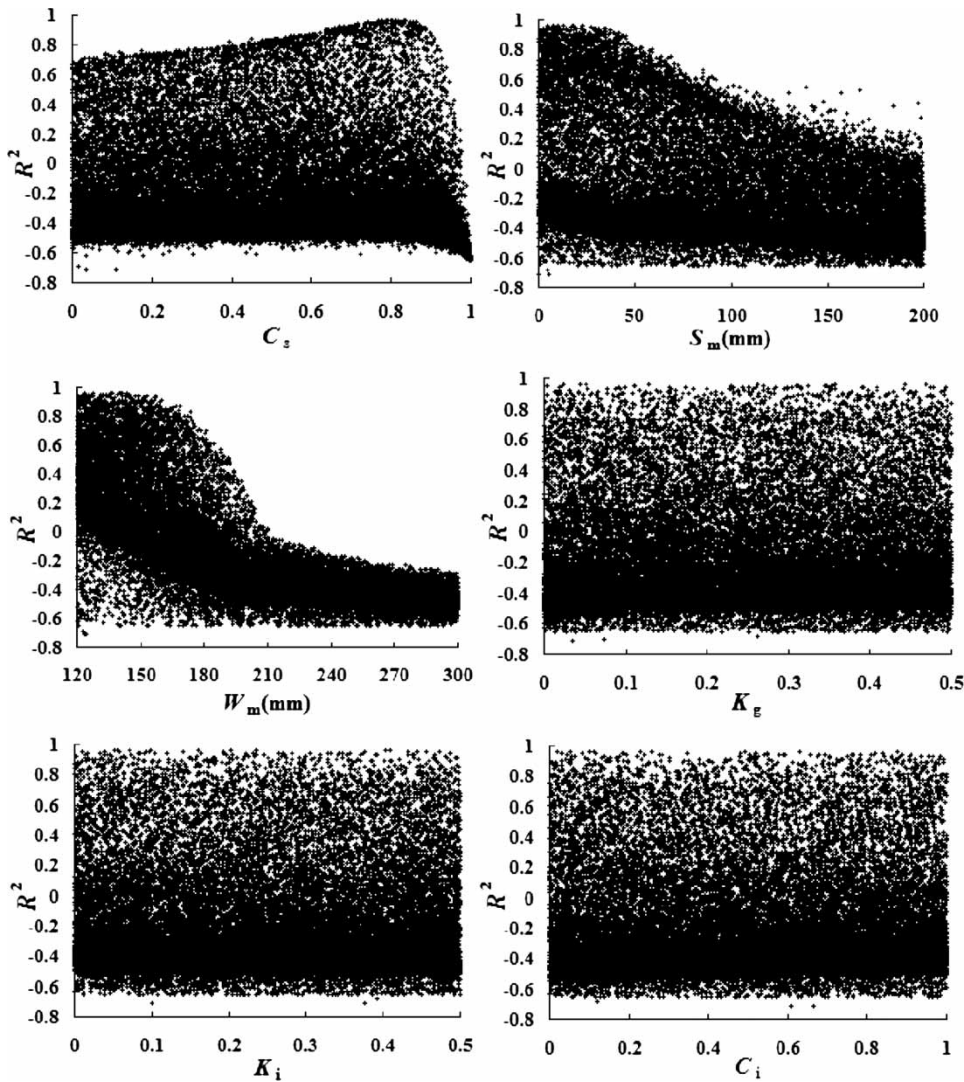

Figure 6 | Scatter plots of the likelihood of some sensitive parameters in runoff routing parameter calibration.

Table 6. The parameters of the three groups vary significantly, but the  $R^2$  value of simulation with the three groups is the same (0.89). To compare the different parameters, they are standardized with Equation (1).

$$X'_{ij} = \frac{X_{ij}}{\sum_{j=1}^m X_{ij}} \quad (1)$$

where  $X'_{ij}$  is the parameter value after standardization,  $X_{ij}$  is the parameter value before standardization,  $i$  is the parameter number,  $j$  is the sampling number and  $m$  is the total sampling number of one parameter.

Figure 7 shows the standardized equifinality parameter groups in Lianghai basin in the runoff routing calibration. With the standardization, the values of all parameters fall within the range 0–1. Each line in Figure 7 represents a group of parameters; the points indicate the standardized values of different parameters.

The results showed that the water balance parameter calibration is most sensitive to parameters  $K$ ,  $C_s$  and  $S_m$ , while the runoff routing parameter calibration is most sensitive to parameters  $C_s$ ,  $S_m$  and  $W_m$ . For the water balance parameter calibration, evaporation evidently affects water balance by one year or several years. Meanwhile for the

**Table 6** | Examples of equifinality parameter groups

Parameter	Group one	Group two	Group three
$K$	0.995	1.02	1.3
$I_m$	0.015	0.02	0.05
$W_m$	120	130	125
$U_m$	20	22	15
$L_m$	70	75	30
$C_s$	0.7	0.695	0.75
$E_x$	1.3	1.15	0.9
$C$	0.15	0.2	0.3
$K_g$	0.2	0.25	0.6
$K_i$	0.5	0.6	0.38
$C_g$	0.8	0.83	0.7
$C_i$	0.5	0.59	0.45
$S_m$	30	25	20
$B$	0.1	0.45	0.2
$R^2$	0.89	0.89	0.89

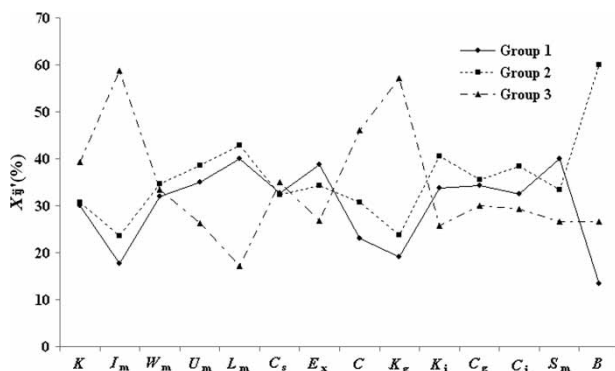
**Figure 7** | The standardization of equifinality parameter groups in Lianghui basin.

runoff routing parameter calibration, flood events which usually last from several minutes to several days are simulated. The evaporation during such a short period may not be very important for runoff generation. That situation might be the reason why  $K$  (in the calculation of evaporation) is important in the water balance parameter calibration but not important in the runoff routing parameter calibration. The parameter  $W_m$  greatly affects the runoff production, and the runoff routing parameter calibration is very sensitive to this parameter. In the water balance parameter calibration however, the function of  $W_m$  might be compensated by the function of  $K$  which has a more notable role in runoff production.  $W_m$  therefore

becomes a less sensitive parameter in the runoff routing parameter calibration. The parameters  $C_s$  and  $S_m$  are parameters related to runoff concentration and runoff separation, respectively. Both calibrations are therefore sensitive to these two parameters.

## CONCLUSIONS

Data scarcity is a common problem hindering model identification and application in many small drainage basins. For the case of the Lianghui basin, there are no precipitation and evaporation data available but only data from neighbouring stations. If parameter values are assigned properly, the results are useful for administrative purposes. In future, due to the advantages of the model and its good application records in China, the Xinanjiang model will continue to play an important role in the humid and semi-humid areas of China. Geographic information systems (GIS) and remotely sensed (RS) data must be introduced to solve the data scarcity problem, however.

The equifinality phenomenon exists for both the water balance parameter calibration and the runoff routing parameter calibration. Different parameter groups can achieve the same results. The water balance parameter calibration was found to be sensitive to parameters  $K$ ,  $C_s$ ,  $S_m$ ,  $K_i$ ,  $W_m$  and  $C_i$ , and the runoff routing parameter calibration was found to be sensitive to parameters  $C_s$ ,  $S_m$ ,  $K_i$ ,  $K_g$ ,  $C_i$  and  $W_m$ . With GLUE methodology, the water balance parameter calibration and runoff routing parameter calibration are also sensitive to different parameters. The water balance parameter calibration is most sensitive to  $K$ ,  $C_s$  and  $S_m$ , while the runoff routing parameter calibration in Lianghui basin is most sensitive to  $C_s$ ,  $S_m$  and  $W_m$ . Using the GLUE method, both water balance parameter calibration and runoff routing parameter calibration were sensitive to fewer parameters. These results will facilitate parameter calibration of the Xinanjiang model.

## ACKNOWLEDGEMENTS

The authors gratefully acknowledge the financial support from the Programme of Introducing Talents of Discipline to Universities (111 Project B08048) and the Key Project

of Chinese Ministry of Education (No. 308012). We also want to express our appreciation for the support for our research in Lianghui from the National Basic Research Program of China (2010CB951103). We are very grateful to the three anonymous reviewers whose comments helped to improve the paper considerably.

## REFERENCES

- Beven, K. & Binley, A. 1992 The future of distributed models: model calibration and uncertainty prediction. *Hydrological Processes* **6** (3), 279–298.
- Beven, K. & Freer, J. 2001 Equifinality, data assimilation, and uncertainty estimation in mechanistic modelling of complex environmental systems using the GLUE methodology. *Journal of Hydrology* **249**, 11–29.
- Cheng, C., Ou, C. P. & Chau, K. W. 2002 Combining a fuzzy optimal model with a genetic algorithm to solve multi-objective rainfall-runoff model calibration. *Journal of Hydrology* **268**, 72–86.
- Cheng, C., Zhao, M., Chau, K. W. & Wu, X. 2006 Using genetic algorithm and TOPSIS for Xinanjiang model calibration with a single procedure. *Journal of Hydrology* **316**, 129–140.
- Dong, X., Li, Z. & Li, L. 2006 Application and comparison of three hydrological models in semi-arid region. *Journal of Hohai University (Natural Sciences)* **34** (2), 132–135 (in Chinese).
- Gan, T. Y., Dlamini, E. M. & Biftu, G. F. 1997 Effects of model complexity and structure, data quality, and objective functions on hydrologic modeling. *Journal of Hydrology* **192**, 81–103.
- Guan, Y., Zhang, D., Spaans, W., Chen, P., Long, X. & Zhang, L. 2006 Application of rainfall-runoff models in two small catchments. In *Proceedings of the international Symposium on Flood Forecasting and Water Resources Assessment for IAHS-PUB*. China WaterPower Press, Beijing, pp. 38–48.
- Hapuarachchi, H. A. P., Li, Z. & Wang, S. 2001 Application of SCE-UA method for calibrating the Xinanjiang Watershed Model. *Lake Science* **13** (4), 304–314.
- Huang, G. & Xie, H. 2007 Uncertainty analyses of watershed hydrological model based on GLUE method. *Journal of South China University of Technology* **35** (3), 137–142 (in Chinese).
- Jin, X., Yang, G., Gu, J. & Li, Q. 2008 Application of Xinanjiang Model in Hunhe River Basin. *Water Conservancy and Irrigation* **11**, 40–42 (in Chinese).
- Ju, Q., Yu, Z., Hao, Z., Ou, G., Zhao, J. & Liu, D. 2009 Division-based rainfall-runoff simulations with BP neural networks and Xinanjiang model. *Neurocomputing* **72**, 2873–2883.
- Li, H., Zhang, Y., Chiew, F. & Xu, S. 2009 Predicting runoff in ungauged catchments by using Xinanjiang model with MODIS leaf area index. *Journal of Hydrology* **370**, 155–162.
- Li, S. & Liang, Z. 2006 Study on GLUE method applied to analyzing uncertainty of Xinanjiang model parameter. *Water Resources & Hydropower of Northeast China* **24** (2), 31–33 (in Chinese).
- Li, Z., Wang, L., Bao, H., Song, Y. & Yu, Z. 2008 Rainfall-runoff simulation and flood forecasting for Huaihe Basin. *Water Science and Engineering* **3** (1), 24–25.
- Lin, C. A., Wen, L., Lu, G., Wu, Z., Zhang, J., Yang, Y., Zhu, Y. & Tong, L. 2006 Atmospheric-hydrological modeling of severe precipitation and floods in the Huaihe River Basin, China. *Journal of Hydrology* **330**, 249–259.
- Mo, X. & Liu, S. 2004 *GLUE Method and Its Application in Analyzing Model Uncertainty. The Complexity of Water Problems and Research on Uncertainty*. Water Conservation and Hydropower Press, Beijing (in Chinese).
- Su, C., Liu, S. & Mo, X. 2008 Uncertainty analysis of Xinanjiang model parameter. *Geography Study* **27** (2), 343–352 (in Chinese).
- Tong, L. 2005 Application of Xinanjiang model in Dongjiang reservoir flood forecast. *Water Conservancy Science and Technology and Economy* **11** (10), 607–609 (in Chinese).
- Wang, L., Li, Z. & Bao, H. 2008 Analysis of three hydrological models for flood simulation in semi-arid and semi-humid watershed. *Water Resources and Power* **26** (4), 47–49 (in Chinese).
- Xie, F., Li, Z. & Yao, C. 2007 The application and comparative study of TOPMODEL and Xinanjiang model. *Water Power* **33** (10), 14–18 (in Chinese).
- Zhang, L., Guan, Y. & Ye, B. 2008 Empirical study on parameter sensitivity analysis of Xinanjiang model. *Water Resources and Power* **26** (5), 16–17 (in Chinese).
- Zhao, C., Zhang, L. & Yang, X. 2007 Application of water hydrological model to river basin. *Environmental Science and Management* **32** (10), 17–21 (in Chinese).
- Zhao, R. 1984 *Catchment Hydrological Modeling*. Water Conservation and Hydropower Press, Beijing (in Chinese).
- Zhao, R. 1992 The Xinanjiang model applied in China. *Journal of Hydrology* **135**, 371–381.
- Zhao, R. & Wang, P. 1988 Analysis of Xinanjiang model parameters. *Journal of Hydrology* **6**, 2–9.
- Zhao, R., Zhuang, Y., Fang, L., Liu, X. & Zhang, Q. 1980 The Xinanjiang model. In *Hydrological Forecasting, Proceedings of the Oxford Symposium*. IAHS Publ. No. 129, Adlard & Son Ltd, Bartholomew Press, Dorking, Surrey, UK, pp. 351–356.

First received 8 October 2009; accepted in revised form 17 August 2010. Available online December 2011