

Evaluation of the rapid filtration system with particle size distribution and *Cryptosporidium* in different operating conditions

M.J. Yu*, S.K. Ahn*, S.H. Chung*, S. Noh*, J.A. Park*, Y.T. Rhim**, W.H. Jheong** and H.M. Chung**

*Department of Environmental Engineering, University of Seoul, 90, Jeonnong-dong, Dongdaemun-gu, Seoul, Korea (E-mail: myong@uos.ac.kr; asknp@uos.ac.kr; shinho@ene.uos.ac.kr; chocolady99@hotmail.com)

**Department of Water Pollution and Microbiology, National Institute of Environmental Research, 2-1 Site, Metropolitan Landfill Area, Kyungseo-dong, Seo-gu, Incheon, 404-170, Korea (E-mail: rimity@me.go.kr; purify@me.go.kr; hyenmic@me.go.kr)

Abstract The characterization of particle behavior in addition to the measurement of turbidity is becoming more important in performance evaluation as well as in the operation of the water treatment system, in order to provide supporting information on small-sized microorganisms such as *Cryptosporidium*. Accordingly, the particle counter has been introduced in the evaluation and operation of the treatment system. However, research results on the relation among turbidity, particle counts and/or protozoa have not been concurrent with each other. Therefore, this study investigated the relation to improve performance evaluation of the sand filter so that the risk of protozoan contamination can be reduced. The study results verified that particle counts provide a better insight into the filtration process than turbidity alone. The counts of 4–7 as well as 7–14 μm , instead of total particle counts, can be used to monitor and operate the rapid sand filter effectively, as it has a better relation with *Cryptosporidium*. Also, the study results showed that the fine single-medium filter is more useful when targeting better water quality despite its low productivity, since it removes small particles more effectively than the dual-media filter. The latter is more useful when targeting better productivity. However, enough depth of sand layer of dual media filter with adequate filtration rate is required to not compromise water quality and productivity, as a shallow sand layer is highly likely to cause an early breakthrough.

Keywords *Cryptosporidium parvum*; particle count; rapid filtration; size distribution; turbidity

Introduction

The characterization of particle behavior is becoming more important in the performance evaluation of the water treatment system as well as in its operation, as turbidity, the conventional parameter, has been reported to be less sensitive particularly at low turbidity levels (Han and Chung, 1998; Shim *et al.*, 2001). Recently the removal of small-size protozoan contamination such as *Cryptosporidium parvum* and *Giardia lamblia* has been seriously considered because of their resistance to chemical disinfectants. There has been no report on their appearance at a significant level in the drinking water system of Korea. But many researchers have carried out studies on this topic (Chung *et al.*, 1999; Lee *et al.*, 2004), seeking easier and reliable monitoring surrogates to resolve the difficulty in detecting *Cryptosporidium* removal in the water systems (Chung *et al.*, 2002). Also similar studies are being undertaken around the world by using the measurement of particle counts in unit operations and processes (Emelko, 2003; Hsu and Yeh, 2003). Accordingly, particle counting has been introduced and its application is now considered as one of the useful approaches in this field. However, despite various discussions on this topic, no agreement has been made on the feasibility of particle counting method instead of the highly sophisticated detection of the protozoa (Ndiongue *et al.*, 2000;

Bridgeman *et al.*, 2002; Hsu and Yeh, 2003). Also the designing/operating criteria based on particle behavior were not set up in terms of a protozoan barrier. In this study, single-medium and dual-media rapid filters were operated to see if they could function as one of multiple barriers to particle contamination in the water treatment system and to find a useful monitoring method for *Cryptosporidium* removal and designing/operating conditions for particle counting and turbidity.

Methodology

Sand and sand/antracite were used for the single-medium and dual-media filters. Settled water from the Guwi Water Treatment Plant was used as an influent of the filter. The experimental instruments and devices are given in Table 1 and the schematic diagram of the plant is shown in Figure 1. The experiment was conducted in different operating conditions; composition of media i.e. single (sand, $d_{10} = 0.607$ mm, uniformity coefficient = 1.381) and dual (sand – same as above/antracite, $d_{10} = 1.097$ mm, UC = 1.483), depth of media i.e. sand:antracite = 25 cm:50 cm, 30 cm:45 cm, filtration rate i.e. 170, 240, 360 m/day and raw water quality i.e. low turbidity (0.5–1.0 NTU), high turbidity (3–5 NTU). In order to simulate malfunctioning states of coagulation and sedimentation processes in the rainy season, sludge concentrate was added to influent water for Mode R3, R4, AH1, AH2, AH3, BH1, BH2 and BH3. Formalin-inactivated *Cryptosporidium parvum* oocysts with controlled number (Waterborne, Inc. 10^8 cells/8 mL of 5% formalin/PBS and 0.01% Tween 20 solution) were spiked in the influent water tank for Mode R1–R5, AH1, AH3, BL1, BL3, BH1 and BH3 after shaking by a vortex vibrator in the beginning of each operation. As self-degradation of *Cryptosporidium* was observed in a warm condition (Mode R1), influent water was kept cool (setting at 10 °C) for all the other conditions. The influent and effluent were monitored with an online particle counter and a turbidimeter. Oocyst concentration was determined by a modified EPA 1622 method (Dugan *et al.*, 2001) and an increase in head losses was checked regularly. Operating conditions are given in Table 2. The influent was maintained pH 6.6–7.6 and conductivity 120–190 μ S/cm. The other drinking water quality parameters were not considered in this study since they were not expected to vary significantly as the influent water was taken from the real water treatment plant which is supplying water to the citizens of Seoul.

Filter run was stopped when the head losses reached an upper limit, when prepared influent water was exhausted, or when turbidity and/or particles began to leak out of the filter.

Results and discussion

Comparison of filtrate qualities among different operating conditions

Operating results were summarized briefly in Table 3. In the case of using highly turbid water as an influent, particle counts and the turbidity of filtrate were low during filtration

Table 1 Contents of the experimental instruments and devices

Item	Content
Column	Acrylic column, Φ 40 mm \times H 3,600 mm (jointed with 3 pieces)
Peristaltic pump	Coleparmer Instrument, Masterflex L/S Model 7518-00
Raw water tank	PVC, W 1,000 mm \times L 1,000 mm \times H 1,000 mm
Equalizer	Acrylic, W 300 mm \times L 300 mm \times H 300 mm (effective capacity W290 mm \times L240 mm \times H215 mm)
Temperature controller	NICETEC Co. Recirculating Chiller, NICECOOL 515
Particle counter	Laser Trac™, Model PC 2400D
Turbidimeter	HF scientific MicroTOL, Hach 1720D/2100P Turbidimeter
Conductivity meter	YSI, conductivity/temperature meter Model 30/50 FT

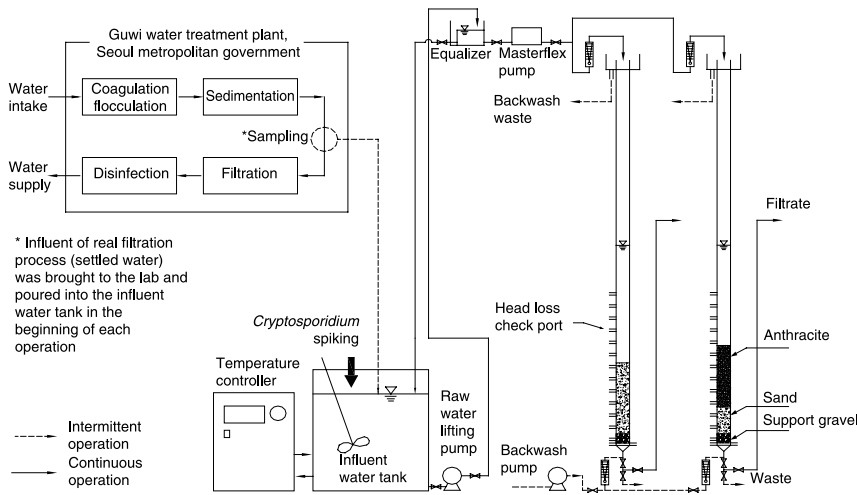

Figure 1 Schematic diagram of the rapid filtration plant

regardless of the filtration rate, when the single-medium filter was used (Figure 2a). And higher particle counts and turbidity were detected in accordance with the filtration rate when the dual-media filter was used (Figure 2b).

In the case of using low turbid water as an influent, particle counts and the turbidity of filtrate were low when the filtration rate was low, but particles leaked in the dual-media filter when the filtration rate was high. Consequently it is thought to be important to maintain the turbidity of raw water at a low level through proper operation of the preceding coagulation–sedimentation process. Also, keeping a filtration rate not so high and using a fine-medium filter is effective, if high water quality is required.

Log removals of *Cryptosporidium* in various operating conditions are shown in Figure 3. Rectangular markers show the average log removals of the whole running period, and circular markers show the average log removals of the effective filtration

Table 2 Operating conditions and influent water quality

Step	Mode	Media	Depth (cm)	Filtration rate (m/day)	Turbidity (NTU)	<i>Cryptosporidium</i> (oocyst/mL)	TPC* (ea/mL)
Step1	R1**	Sand	60	120	0.504 (low)	43,800	1,074.5
	R2	Sand	60	120	0.425 (low)	37,400	592.1
	R3	Sand	60	120	4.027 (high)	52,000	8,008.7
	R4	Sand:anthracite	25:50	170	3.908 (high)	34,000	3,676.8
	R5	Sand:anthracite	25:50	170	0.808 (low)	78,800	1,741.9
Step2	AL1	Sand:anthracite	25:50	170	0.537 (low)	–	3,963.8
	AL2	Sand:anthracite	25:50	240	0.612 (low)	–	–
	AL3	Sand:anthracite	25:50	360	1.180 (low)	–	1,518.9
	AH1	Sand:anthracite	25:50	170	3.800 (high)	62,400	6,197.5
	AH2	Sand:anthracite	25:50	240	2.790 (high)	–	11,785.5
	AH3	Sand:anthracite	25:50	360	2.819 (high)	66,600	10,575.5
	BL1	Sand:anthracite	30:45	170	0.519 (low)	50,400	4,492.5
	BL2	Sand:anthracite	30:45	240	1.879 (low)	–	5,502.8
	BL3	Sand:anthracite	30:45	360	0.875 (low)	72,600	4,292.1
	BH1	Sand:anthracite	30:45	170	3.032 (high)	43,800	12,437.7
	BH2	Sand:anthracite	30:45	240	3.400 (high)	–	11,381.5
	BH3	Sand:anthracite	30:45	360	3.000 (high)	58,200	8,456.4

*Total particle counts (2 μm–over 100 μm) per 1 mL water

**Raw water of R1 mode at room temperature, all the other modes at 10–15 °C

Table 3 Results of each operating mode

Mode	Head loss gradient (cm/hr)	Removal type	Filter run time (h)	Filtrate volume (L/cycle)	Net production* (L/week)	Stop condition
R1	0.36	Surface	72	452.4	978.4	Raw water exhausted
R2	0.55	Surface	72	452.4	978.4	Raw water exhausted
R3	1.75	Surface	51	320.4	946.9	Head loss limit
R4	0.28	Depth	66	587.5	1,408.0	Accidental breakthrough at 66 h
R5	0.34	Depth	72	640.9	1,415.2	Raw water exhausted
AL1	0.33	Surface + depth	114	1,014.7	1,444.6	Accidental breakthrough at 114 h
AL2	0.36	Surface + depth	107	1,344.6	2,054.2	Accidental breakthrough at 107 h
AL3	0.50	Depth	91	1,715.3	3,094.1	Accidental breakthrough at 91 h
AH1	1.44	Depth	48	427.3	1,375.5	Breakthrough at 48 h
AH2	1.51	Depth	42	527.8	1,967.1	Breakthrough at 42 h
AH3	1.58	Depth	13	245.0	2,674.1	Gradual breakthrough at 13 h
BL1	0.49	Depth	64	569.7	1,405.3	Raw water exhausted
BL2	0.38	Depth	66	829.4	2,019.1	Raw water exhausted
BL3	0.22	Depth	18	339.3	2,807.3	<i>Cryptosporidium</i> seepage at 18 h
BH1	1.91	Surface + depth	31	275.9	1,310.8	Gradual breakthrough at 31 h
BH2	1.86	Surface + depth	29	364.4	1,903.6	Gradual breakthrough at 29 h
BH3	2.65	Surface + depth	10	188.5	2,533.4	Gradual breakthrough at 10 h

*Net production is total filtrate volume per unit time deducting back wash water volume

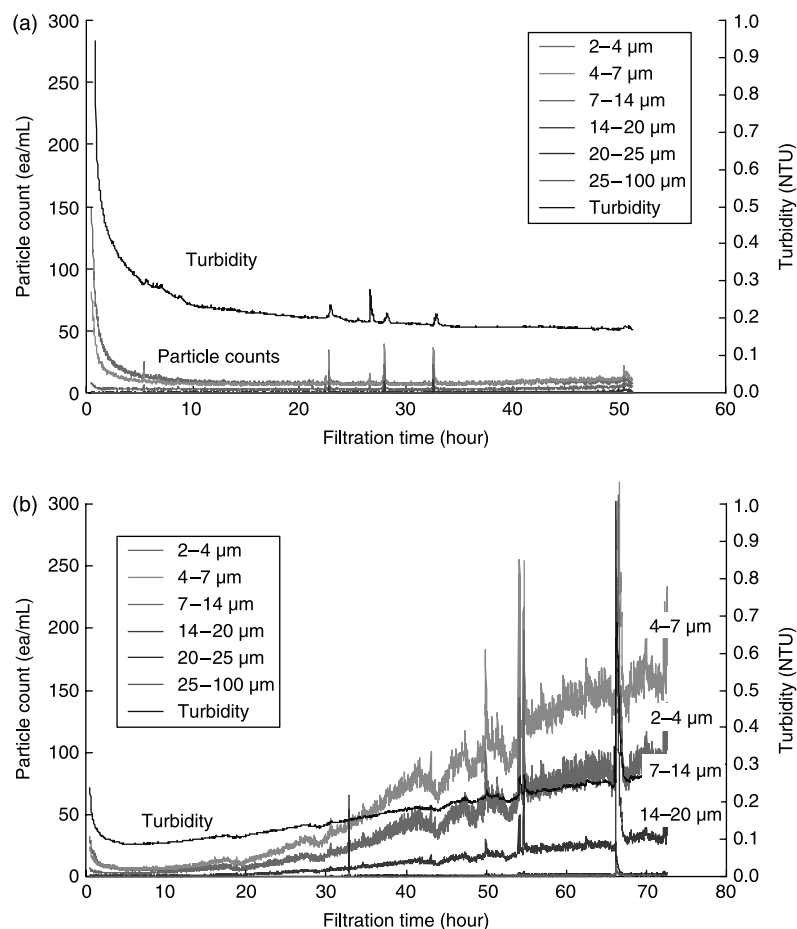

Figure 2 Comparison of filtrate qualities between single-medium and dual-media filters, (a) Single-medium filter (R3); (b) Dual-media filter (R4)

stage. Their maximum, median and minimum values were drawn together. Log removals in single-medium filters (R1, R2, R3) were relatively higher and their variations were smaller than those in dual media filters. Log removals in high filtration rates were smaller than those in low filtration rates (AH3 vs. AH1, BL3 vs. BL1, BH3 vs. BH1). In the case of dual-media filters, log removals in high turbid influent were lower than those in low turbid influent (R4 vs. R5, BH1 vs. BL1, BH3 vs. BL3). However, log removals in high turbid influents were slightly higher than those in low turbid influents (R3 vs. R2) in the case of single-medium filters. The reason seems to be that small particles passed through relatively big pores of the anthracite layer and leaked relatively early from the shallow sand layer (25 cm, 30 cm) in the case of the dual media. And the deep sand layer (60 cm) did not allow most particles to pass through in the case of single-medium filters. Therefore, it is necessary to perform a further investigation in this phenomenon with a deeper layer (over 30 cm) of finer sand (smaller than $d_{10} = 0.6$ mm) in a dual-media condition. According to this comparison, it can be suggested that using a finer medium is beneficial in case of targeting high water quality, if low productivity does not matter.

Comparison of productivity between different operating conditions

Head loss gradient in each mode was calculated based on the total head loss increase and the filter run time. In the case of using a dual-media filter with a highly turbid influent and a high

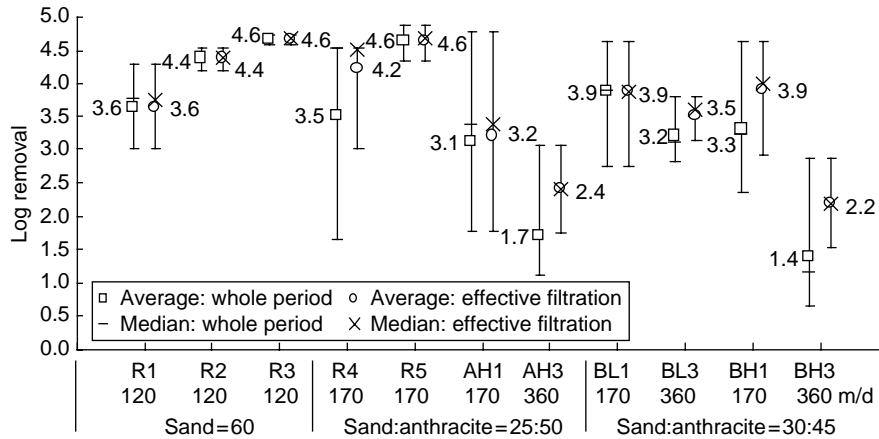

Figure 3 Log removal of *Cryptosporidium* in different operating conditions

filtration rate, filter run time was shorter than the other conditions because small sized particles including *Cryptosporidium* leaked early. This means that the higher the influent turbidity and filtration rate, the shorter the run length as shown in Table 3 and Figure 4. Also it was observed that particles were kept on the surface in the case of single-medium filters, while they were kept in depth in the case of dual-media filters. The increasing trends of head losses in single-medium and dual-media filters appeared typical as shown in Figure 5.

However, these results can be reviewed in a different way. When net filtrate production per unit time of each operating mode was calculated based on filtration rates, run length and simple backwash with a velocity of 0.8 m/min and a duration of 30 min, the productivity of an operating condition with a high filtration rate was higher as shown in Figure 6. When compared to other filtration rates, however, the case of the highest filtration rate (360 m/day) produced a worse quality of water regarding particles and *Cryptosporidium* even though the turbidity was in the range of 0.3–0.5 NTU. Therefore, it can be thought that a higher filtration rate should be used within a limited range, if high productivity is required. It was also observed that the higher the influent turbidity, the smaller its productivity. But the differences in the net productions between high influent run and low turbid influent run were very small, because most runs of low turbid influents were stopped by the exhaustion of the prepared raw water. If those runs had been operated until breakthrough, their differences would have been much greater. If a high filtration rate is required, water quality monitoring should be more stringent in order to prevent leakage of small-sized particles which has a potential risk in case of possible malfunction of coagulation–sedimentation processes especially during the rainy season. If a high filtration rate is not required – in other words, if low productivity does not matter – the impact of high turbid loading may not be significant in water quality.

Relationship between particle counts and turbidity

Coefficients of correlation (Pearson) of particle counts and turbidity, calculated within individual operating conditions, were drawn in the box-whisker plot of Figure 7. Their maximum, 3rd quartile, median, 1st quartile and minimum values of the coefficient were shown together. While maximum values were almost the same as one another, the variations of the coefficients in the case of 2–4 μm , 20–25 μm and 25–100 μm were greater than in the case of 4–7 μm and 7–14 μm . This indicates that the relation between the counts of particles sized 2–4 μm , 20–25 μm , 25–100 μm and turbidity may be

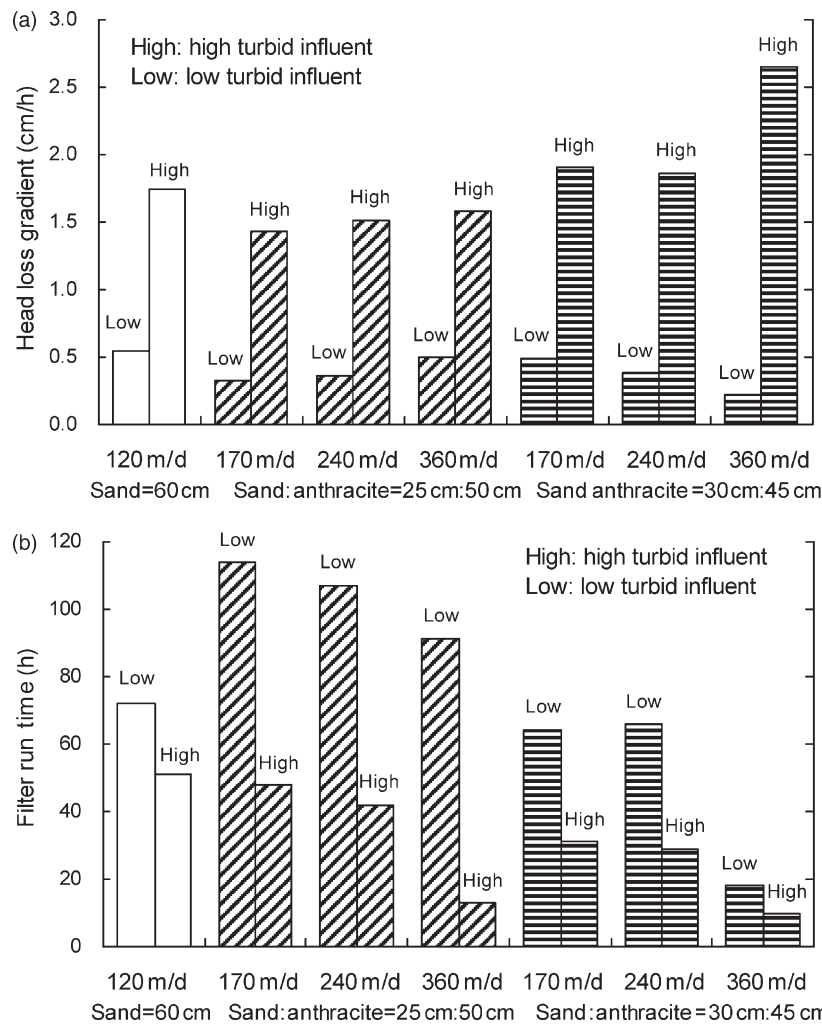

Figure 4 Comparison of head loss gradient and filter run time, (a) Head losses increasing rate; (b) Filter run time

significant in some cases (large correlation coefficient) but at the same time may be insignificant in other cases (small correlation coefficient). The coefficients of correlation in the case of 4–7 μm and 7–14 μm were relatively high and the variations were small. This indicates that the relation between the counts of particles sized 4–7 μm and 7–14 μm may be relatively significant in most cases.

Apart from this comparison, the correlation coefficients were calculated with the mixed data of all conditions and plotted as filled-diamond markers. The coefficients in the case of 2–4 μm , 20–25 μm and 25–100 μm were very small and the coefficient for 14–20 μm was relatively small compared to those for 4–7 μm and 7–14 μm . Within a unique operating condition ('intra-condition'), physico-chemical characteristics of particles must be apparently the same, resulting in significant correlation between particle counts and turbidity. However, characteristics of particles in one operating condition may differ from those in other operating conditions, resulting in insignificant correlation, if calculated with all the mixed data of different conditions ('inter-conditions'). According to this comparison, the particle count–turbidity relations in 4–7 μm and 7–14 μm range were better than in other ranges.

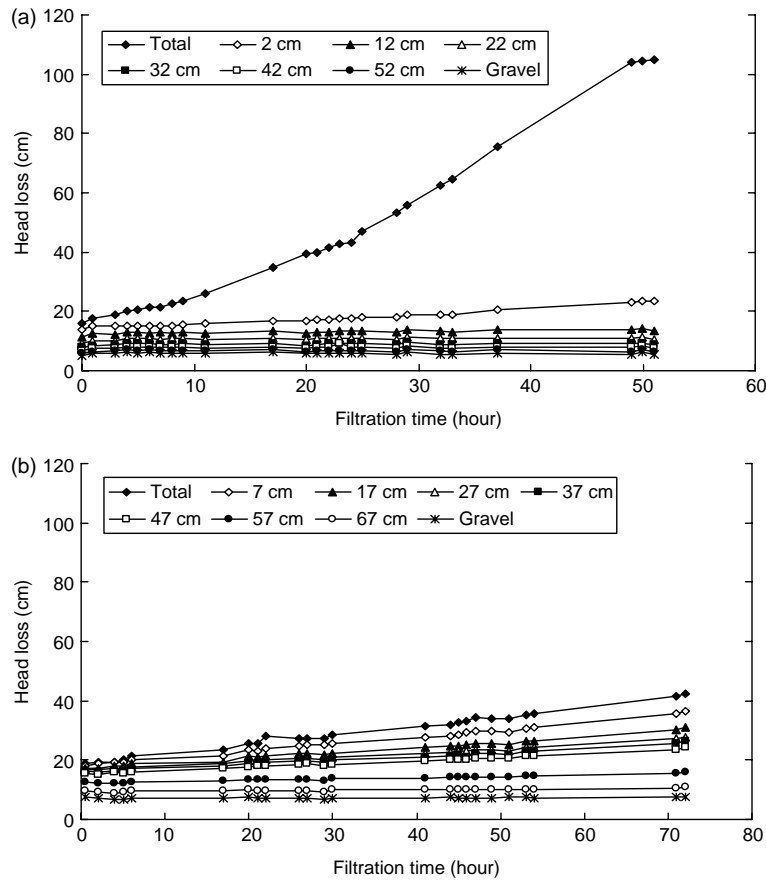

Figure 5 Head loss increases in single-medium and dual-media filters. (a) Single-medium filter (R3); (b) Dual-media filter (R4)

The results of the reduced correlations between turbidity and particle counts, particularly in 2–4 μm , 20–25 μm and 25–100 μm ranges, even if strong correlation was observed in a few limited conditions, were well verified with the results of [Bridgeman et al. \(2002\)](#) about some discordance between turbidity and particle counts, because turbidity is related not only to particle counts but also to the nature of particles, such as light scattering or absorbing properties.

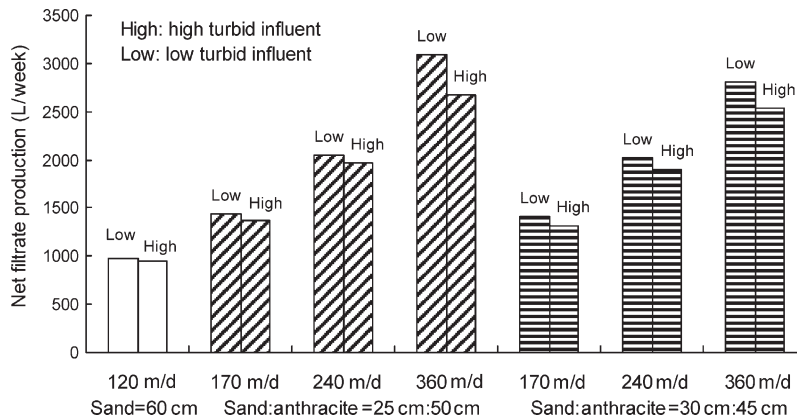

Figure 6 Comparison of net filtrate production per unit time

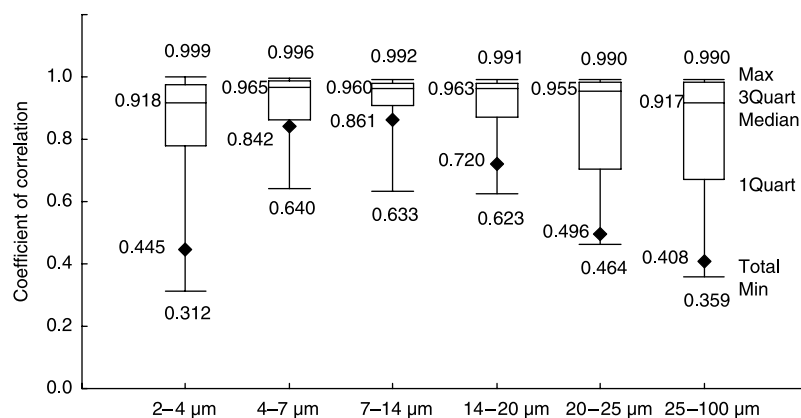

Figure 7 Coefficients of correlation of particle count in each size range and turbidity

It is important to note that the decreased correlation between turbidity and particle counts in 2–4 μm came from the uncontrolled operational conditions. In some experiments with highly turbid influents, the particles of 4–7 μm and 7–14 μm in size were degraded into small ones of 2–4 μm in size after sludge was added, resulting in an increased number of small-sized particles without an apparent increase in turbidity (data not shown). In those cases, turbidity could not indicate the small-sized particles properly, and correlation dropped due to the impaired conditions. This result supports the importance of the effectiveness of coagulation pretreatment on the removal of the *Cryptosporidium* and surrogate parameters of turbidity and particle counts in rapid filtration (Dugan *et al.*, 2001).

Relationship between particle counts and *Cryptosporidium*

Similarly to the comparison mentioned above, correlation coefficients (Pearson) of particle counts and *Cryptosporidium* were calculated within individual operating conditions and drawn in the box-whisker plot of Figure 8 with their maximum, 3rd quartile, median, 1st quartile and minimum values. Even though maximum values were almost 1 – implying excellent correlation between particle counts and *Cryptosporidium* in some limited cases – the variations of the coefficients in the case of 2–4 μm, 14–20 μm, 20–25 μm and 25–100 μm were so great – implying no correlation between two parameters in other cases. Even adverse correlation (minus value) was observed in 25–100 μm ranges. This indicates that the ‘particle count – *Cryptosporidium*’ relation in 2–4 μm, 20–25 μm and 25–100 μm does not exist from the result. In the case of 4–7 μm and 7–14 μm, not only excellent correlations and small variations were observed when calculated with the data of ‘intra-condition’ but also the coefficients (filled-circular makers) were relatively great when calculated with the data of ‘inter-conditions’. The high correlation between the particle counts of 4–7 μm and the detected oocyst counts may be acceptable, since the size of the *Cryptosporidium* oocyst ranges from 4–6 μm (sometimes 2–8 μm). Also the reason showing high correlation between 7–14 μm and oocysts may be understood as the oocysts are swept by the bigger (7–14 μm) flocs and come out of the filter with the flocs. But much bigger flocs ranging 20 μm and above may not have good correlations because they are not likely to exist in the filtrates at sufficient concentration in normal operations. Therefore, it is suggested that monitoring the particle counts of 4–7 μm and 7–14 μm is beneficial to indicate *Cryptosporidium* or its removal in addition to monitoring total particles when particle counting is applied to a rapid filtration system.

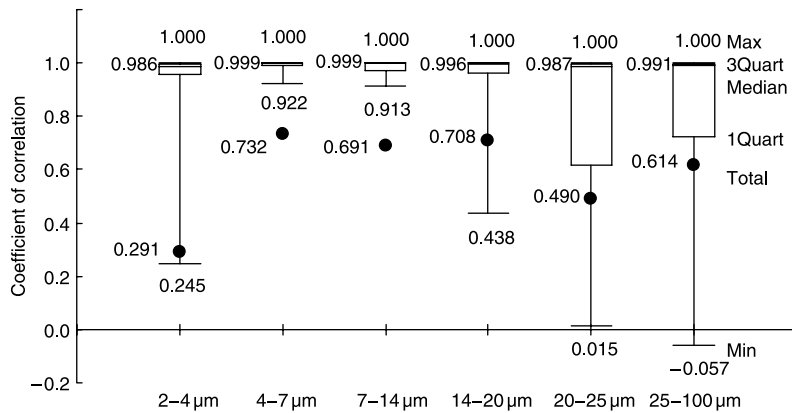

Figure 8 Correlation coefficients of particle counts in each size range and *Cryptosporidium*

A large number of similar-sized particle counts with *Cryptosporidium* do not necessarily mean the existence of *Cryptosporidium* at high levels, but the particle counts in filtered water can reflect the effective removal of *Cryptosporidium* at a rapid filtration system, where the risk potential of *Cryptosporidium* is significant. Therefore, even though the particle counts cannot be used as a 'sufficient' indicator, they can be used as a conservative one of *Cryptosporidium* contamination.

Conclusions

The results of this study suggest that a fine single-medium filter is more reliable if better water quality is the target, particularly to prevent a potential leakage of disinfectant-resistant pathogens such as *Cryptosporidium parvum* and *Giardia lamblia* if its low filtration rate is acceptable. The reason is that a fine single-medium filter removes smaller particles better than a dual-media filter. A dual-media filter with a high filtration rate is more reliable when targeting better productivity, as its filtrate volume is higher than a single-medium filter or a low filtration rate. However, because the shallow sand layer of a dual-media filter with greatly high filtration rate may cause an early breakthrough of particles and produce low quality of water, the sand layer and the filtration rate should be maintained at sufficient levels, in order not to compromise water quality and productivity.

Although turbidity showed good correlations with particle counts including similar-sized particles with protozoa such as *Cryptosporidium* (4–7 μm) and *Giardia* (7–14 μm) in some cases, it could not determine the existence of small-size particles (2–4 μm) properly in the conditions reflecting malfunction of coagulation process. Therefore, particle counting is a more sensitive parameter providing a better insight into the filtration process than turbidity alone.

It is also suggested that counts of 4–7 μm and 7–14 μm particles could be useful indicators of *Cryptosporidium* for effective monitoring and operating rapid filtration systems, as they have better relations with *Cryptosporidium*, compared to the total particle or bigger-size particle counts.

References

- American Public Health Association, American Water Works Association and Water Environment Federation (2000). *Standard methods for the examination of water and wastewater*, 20th edition.
- Bridgeman, J., Simms, J.S. and Parsons, S.A. (2002). Practical and theoretical analysis of relationships between particle count data and turbidity. *Journal of Water Supply: Research and Technology-AQUA*, **51**(5), 263–271.

- Chung, H.M., Yoon, J.Y. and Ryu, J.K. (1999). Drinking water and *Cryptosporidium*. *Journal of KSWQ*, **15**(1), 1–11.
- Chung, H., Rim, Y., Kwon, O., Yeom, C., Cho, M., Lee, C. and Yoon, J. (2002). Practical selection of microorganisms indicating the stability of pathogenic removal in water treatment plants. *Water Science and Technology: Water Supply*, **2**(5–6), 373–380.
- Dugan, N.R., Fox, K.R., Owens, J.H. and Miltner, R.J. (2001). Controlling *Cryptosporidium* oocysts using conventional treatment. *Journal of the AWWA*, December, 64–76.
- Emelko, M.B. (2003). Removal of viable and inactivated *Cryptosporidium* by dual- and tri-media filtration. *Water Research*, **37**, 2998–3008.
- Han, M.Y. and Chung, Y.K. (1998). Particle count and its applicability to the water treatment processes, *Proceeding of KSCE conference*, Vol. 3, pp. 463–467.
- Hsu, B.M. and Yeh, H.H. (2003). Removal of *Giardia* and *Cryptosporidium* in drinking water treatment: a pilot-scale study. *Water Research*, **37**, 1111–1117.
- Lee, M.Y., Cho, E.J., Byun, S.H., Kim, T.H., Oh, S.J. and Ahn, S.K. (2004). Evaluation on removal of *Cryptosporidium* oocysts and *Giardia* cysts by flocculation and sedimentation. *Journal of KSEE*, **26**(4), 397–403.
- Ndiongue, S., Desjardins, R. and Prévost, M. (2000). Relationship between total particle count, aerobic spore-forming bacteria and turbidity in direct filtration. *Journal of Water Supply: Research and Technology-AQUA*, **49**(2), 75–87.
- Shim, Y.S., Yu, M.J. and Han, I.S. (2001). Evaluation of filtration process using particle size distribution. *Journal of KSEE*, **23**(7), 1103–1112.