

Comparison of the robustness-based optimal designs of water distribution systems in three different formulations

Donghwi Jung, Doosun Kang, Gunhui Chung and Joong Hoon Kim

ABSTRACT

Robustness is generally defined as a system's ability to stay within satisfactory bounds against variations in system factors. Recently, robustness has been indicated to be a useful objective function for the optimal design of water distribution systems (WDSs). While various formulations are possible to represent WDS robustness, few efforts have been made to compare the performances of these formulations. This study examined three potential formulations for quantifying system robustness to provide guidelines on the usage of a robustness index. Giustolisi *et al.*'s robustness index (see Giustolisi *et al.* (2009) 'Deterministic versus stochastic design of water distribution networks', *J. Water Resour. Plann. Manage.* **135** (2), 117–127) was adopted to calculate nodal robustness, while the system robustness was defined using three different formulations: (1) minimum among nodal robustness values; (2) total sum of nodal robustness; and (3) sum of nodal robustness at multiple critical nodes. The three proposed formulations were compared through application to identify the most appropriate one for enhancing system robustness in general; three representative benchmark networks were optimally designed to minimize the economic cost while maximizing the system robustness.

Key words | multi-objective optimization, robustness-based design, system robustness formulation

Donghwi Jung

Department of Civil Engineering and Engineering Mechanics,
The University of Arizona, Tucson, AZ 85721, USA

Doosun Kang

Department of Civil Engineering,
Kyung Hee University,
1 Seocheon-Dong, Giheung-Gu,
Yongin-Si, Kyunggi-do 446-701,
South Korea

Gunhui Chung

Department of Civil Engineering,
Hoseo University, Baebang-eup, Asan-si,
Chungcheongnam-do 336-795,
South Korea

Joong Hoon Kim (corresponding author)

School of Civil, Environmental and Architectural Engineering, Korea University,
Anam-dong, Seongbuk-gu, Seoul 136-713,
South Korea
E-mail: jaykim@korea.ac.kr

NOMENCLATURE

The following symbols and acronyms are used in this paper:

a	parameter of pipe cost equation	i	index for nodes
α_c	nodal robustness at critical node (i.e. minimum nodal robustness value of the network)	j	index for pipes
α_i	nodal robustness at i th node	$J_{i,in}$	set of pipes supplying node i
C	set of critical nodes (i.e. five nodes with lowest nodal robustness values)	$J_{i,out}$	set of pipes carrying flow from node i
C_{HW}	Hazen–Williams roughness coefficient	K_u	unit constant of the Hazen–Williams head loss equation
CV_i	coefficient of variation of nodal pressures at i th node	L	length of pipe
D	vector of decision variables	L_j	length of j th pipe of the network
D	pipe diameter	n	exponential coefficient of the pipe cost equation
D_j	diameter of j th pipe of the network	n_n	total number of network nodes
H_A	total head at node A	n_l	total number of network pipes
H_B	total head at node B	P_i	pressure at i th node of the network
h_L	head loss in pipe	\underline{P}	allowable lower bound of nodal pressure
$h_{L,j}$	head loss in j th pipe of the network	\bar{P}	allowable upper bound of nodal pressure
		P_i^{avg}	mean of stochastic nodal pressures at the i th node
		Q	flow in pipe

doi: 10.2166/hydro.2013.055

Q_j	flow in j th pipe of the network
q_i	nodal demand at node i
σ_i	standard deviation of stochastic nodal pressure at i th node
CV	coefficient of variation
FOSM	first-order second-moment
Hanoi WDN	Hanoi water distribution network
LHS	Latin hypercube sampling
MCS	Monte Carlo simulation
NSGA-II	Non-dominated sorting genetic algorithm II
NYT	New York tunnels
WDS	water distribution system

INTRODUCTION

A water distribution system (WDS) is a manmade infrastructure that supplies drinking water to demand points while satisfying a minimum pressure requirement and maintaining good water quality. Early studies on optimal water distribution systems design used a least-cost design approach (Schaake & Lai 1969; Alperovits & Shamir 1977; Lansey & Mays 1988; Simpson *et al.* 1994; Savic & Walters 1997). However, least-cost designed systems often have poor hydraulic redundancy against system uncertainties. Thus, design approaches that consider several measures of system performance along with the economic cost have been suggested. While designs based on head deficiency (Farmani *et al.* 2003) and resilience (Todini 2000; Prasad & Park 2004; Farmani *et al.* 2005) are less popular, reliability-based designs are widely applied (Lansey *et al.* 1989; Xu & Goulter 1999; Babayan *et al.* 2005; Kapelan *et al.* 2005).

System reliability is generally defined as the ability of a network to provide adequate service to customers under uncertain system conditions (Goulter 1995). Lansey *et al.* (1989) were the first to develop a least-cost design methodology under the assumption that the nodal demands, pressure head requirements, and pipe roughness coefficients are variable. They considered system reliability as the design objective of a chance-constrained model. After their study, significant efforts were devoted to the optimal design of WDS considering parameter uncertainties;

multi-objective optimization algorithms were introduced to include system performance measures as a second objective in the optimal system design. Before the transition to a multi-objective framework, the chance-constrained model was used to mitigate the computational burden of quantifying uncertainty. Xu & Goulter (1999) introduced a least-cost design with a reliability constraint and used the first-order reliability-method (FORM) to approximate the uncertainties in the nodal pressure. Babayan *et al.* (2005) proposed a chance constraint-based least-cost design of WDS under demand uncertainty that uses an integration-based approach to overcome the shortcomings of the Monte Carlo simulation (MCS).

Kapelan *et al.* (2005) were the first to use a multi-objective approach for WDS design; they minimized the economic cost while maximizing the system reliability in a single optimization run. The sources of uncertainty were nodal demands and pipe roughness coefficients. The Latin hypercube sampling (LHS) technique was used to quantify uncertainty rather than MCS to mitigate the computational intensity.

As reliability-based design became a general framework for multi-objective WDS design, reliability was often inappropriately used as a measure of system robustness. Robustness is generally defined as a system's ability to maintain its functionality even when perturbations in the system factors occur; therefore, it is concerned with the persistence of the system (Jen 2002). In contrast, system reliability is the probability that a system provides adequate service under uncertain system conditions (Goulter 1995). Thus, the reliability is usually measured by the probability that the stochastic nodal pressures are equal to or greater than the prescribed minimum pressure limit (Lansey *et al.* 1989; Xu & Goulter 1999; Kapelan *et al.* 2005; Giustolisi *et al.* 2009). In short, reliability-based design mainly focuses on increasing service success probability, while robustness-based design is more focused on variation in the system behavior (Jen 2002; Lansey 2012).

A few studies have examined system robustness for design problems. Uber *et al.* (1991a, b) developed a robust optimization model for the design of wastewater treatment plants. They optimized the annual total system cost with the robustness measure as a constraint; this was defined as the weighted sum of the absolute magnitudes of performance function sensitivity coefficients. Recently,

Giustolisi *et al.* (2009) introduced a robustness-based WDS design with a two-stage optimization framework to lessen the computational efforts. The second objective in their study was to achieve a higher probability that pressure was greater than the minimum pressure requirement while simultaneously lowering its standard deviation. The robustness index is the most appropriate measure to enhance the probability of service success and reduce the variations in system hydraulics.

Giustolisi *et al.* (2009) used the minimum nodal robustness index as the objective function to be maximized; this is the usual formulation to evenly increase nodal system performance measures. However, Hashimoto (1982) noted that minimum/maximum and maximum/minimum criteria only focus on the worst-case measures for the system, without considering the overall system performance. Giustolisi *et al.* (2009) noted the limitations of their formulation and suggested that larger and more complex networks may require measurement of the performance of a group of critical nodes.

Despite the acknowledged limitation of minimum/maximum and maximum/minimum formulations, there have been few subsequent efforts to identify appropriate alternatives to measure system robustness. The present study aimed to determine the most appropriate formulation of system robustness to enhance the overall system design and function as well as finally provide guidelines on the usage of a robustness-index formulation. The robustness index introduced by Giustolisi *et al.* (2009) was adopted to calculate the nodal robustness, and three different formulations to quantify system robustness were proposed. The first formulation uses the same max/min formulation as that of Giustolisi *et al.* (2009); the second formulation uses the total sum of nodal robustness values as the system robustness; and the third formulates the system robustness as the sum of nodal robustness at multiple critical nodes. As case studies, three well-known benchmark networks were employed to determine the optimal design under multiple criteria. The system robustness values of the optimal designs obtained for each benchmark study were compared. Non-dominated sorting genetic algorithm II (NSGA-II) (Deb *et al.* 2002) used for multi-objective optimization and LHS was employed to quantify uncertainties for the two uncertain variables of nodal demands and pipe roughness coefficients.

HYDRAULIC RELATIONSHIPS IN A WDS

The hydraulic relationships in a WDS under steady conditions are defined by the conservations of mass and energy. The conservation of mass can be written by using the nodal flow continuity, which must be satisfied at each node:

$$\sum_{j \in J_{i,\text{in}}} Q_j - \sum_{j \in J_{i,\text{out}}} Q_j = q_i \quad (1)$$

where Q_j are the pipe flows and q_i is the nodal demand; a positive value of the pipe flow means that the flow is entering a node. $J_{i,\text{in}}$ and $J_{i,\text{out}}$ are the sets of pipes supplying flow to and carrying flow from node i , respectively.

The conservation of energy can be written by using a pipe head-loss equation. The equation for pipe i connecting nodes A and B is given as:

$$H_A - H_B = h_{L,j} \quad (2)$$

where H_A and H_B are the total energies at nodes A and B, respectively, and $h_{L,j}$ is the head loss in pipe j . The Hazen–Williams equation is commonly used to estimate the head loss in WDS pipes:

$$h_L = K_u \left(\frac{Q}{C_{\text{HW}}} \right)^{1.852} \frac{L}{D^{4.87}} \quad (3)$$

where K_u is a unit constant and D , L , Q , and C_{HW} are the diameter, length, flow, and Hazen–Williams roughness coefficient, respectively, of the pipe. The WDS modeling software EPANET iteratively solves this set of nonlinear equations (Equations (1)–(3)) using the gradient method (Todini & Pilati 1987).

METHODOLOGY

This study compared three formulations of system robustness as a second objective function for a multi-objective WDS design that minimized total cost and maximized system robustness. The following subsections describe the

details of the objective functions and optimization approach applied in this study.

Objectives

Economic cost

The objective function of the economic cost can be mathematically stated as a function of the pipe diameter and length (Savic & Walters 1997):

$$\min f_1(\mathbf{D}) = \sum_{j=1}^{n_l} \alpha D_j^n L_j \quad (4)$$

where \mathbf{D} is the vector of decision variables (i.e. pipe diameters); α is a constant for the pipe cost equation; D_j is the diameter of pipe j selected from a set of commercial pipes ($j = 1, \dots, n_l$); n_l is the number of pipes in the network; L_j is the length of pipe j ; and n is the exponential coefficient. The pipe cost is calculated in the currency of USD.

Note that the WDS optimization problem is constrained by the conservations of mass and energy shown in Equations (1) and (2), respectively. Here, these constraints are implicitly satisfied through a hydraulic simulation using EPANET.

The operational constraint of the minimum nodal pressure requirement is explicitly evaluated for all system nodes:

$$\underline{P} \leq P_i, \quad i = 1, \dots, n_n$$

where P_i is the pressure at node i ($i = 1, \dots, n_n$); n_n is the number of nodes in the network; and \underline{P} is the minimum nodal pressure required.

Nodal robustness index

As noted above, the robustness is related more to variations in the system pressure (Jen 2002), while system reliability is generally expressed as the success probability of the system performance (i.e. satisfying minimum pressure requirement). Here, the nodal robustness index α is expressed as the inverse of the coefficient of variation (CV) of the stochastic nodal pressure. It is similar to the robustness index suggested by Giustolisi et al. (2009);

however, the minimum nodal pressure is not subtracted from the numerator, since only the designs that satisfy the minimum pressure constraint are considered for the robustness index calculation. The robustness index is expressed as:

$$\alpha_i = \frac{1}{CV_i} = \frac{P_i^{\text{avg}}}{\sigma_i} \quad (5)$$

where α_i is the nodal robustness at node i ; CV_i is the coefficient of variation of nodal pressures at node i ; and P_i^{avg} and σ_i are the mean and standard deviation, respectively, of the stochastic nodal pressures at node i .

As the system cost is increased, the system capacity usually gains more redundancy owing to the increased pipe diameters in the network. The increased pipe diameters both increase the mean pressure and decrease the variation in random pressures at a given node. Therefore, an increased system economic cost probably increases the robustness index as well.

Three formulations of system robustness

This study proposed and evaluated three system robustness formulations as a second objective function for multi-objective WDS optimization. These three formulations are described below.

1. Formulation 1 – System robustness is defined as the minimum nodal robustness value:

$$\max f_2(\mathbf{D}) = \alpha_c \quad (6)$$

where α_c is the nodal robustness index at a critical node (i.e., minimum nodal robustness value).

2. Formulation 2 – System robustness is defined as the sum of all nodal robustness values:

$$\max f_2(\mathbf{D}) = \sum_{i=1}^{n_n} \alpha_i \quad (7)$$

3. Formulation 3 – System robustness is defined as the sum of nodal robustness values at multiple critical nodes:

$$\max f_2(\mathbf{D}) = \sum_{i \in C} \alpha_i \quad (8)$$

where C is the set of critical nodes that are defined as the five nodes with the lowest nodal robustness values.

Uncertainty quantification method: LHS

Three well-known approaches are generally applied to quantify nodal pressure variations: MCS, first-order second-moment (FOSM) analysis, and LHS. MCS is a random enumeration technique in which a large set of samples is developed and evaluated. MCS is assumed to be correct with a sufficient sample size but inefficient in an optimization framework owing to its intensive computational requirements. FOSM is a variance approximation method that uses a parameter gradient and Taylor series. LHS is a quasi-MCS that uses a stratified sampling approach. FOSM and LHS are often used as alternative approaches to MCS to reduce the computational effort during an optimization process. This study employed LHS since it significantly reduces the sampling size and has been proven to be more accurate than FOSM for WDS uncertainty estimation (Kang *et al.* 2009).

The nodal demands and pipe roughness coefficients were considered to be uncertain variables following a normal distribution. To generate a random set of these input parameters, a CV of 0.1 (i.e. $\sigma = 0.1 \times \mu$) was assumed for both parameters. To avoid sampling extreme values at the tails of the probability density function (PDF), sampled values exceeding 80% of the mean value were discarded. For example, if the mean parameter value was 100, any sampled values below 20 or above 180 were neglected.

Multi-objective optimization

NSGA-II (Deb *et al.* 2002) is an improved version of NSGA (Srinivas & Deb 1994) that provides better performance when solving multi-objective optimization problems. In the GA selection process for the next generation, NSGA-II considers the rank and diversity of each solution in the current population.

The diversity of the solution is estimated from the so-called ‘crowding-distance’ calculation. The distance is equal to the perimeter of the cuboid formed using the near-neighbor solutions as vertices of the solution space.

Therefore, if the neighbor solutions of the solution are far from it, the diversity of the solution is high. The ability of NSGA-II to consider diversity makes it possible to have a Pareto front cover a wide range of objective functions. When a population is developed over a generation, NSGA-II selects individuals based on their rank and diversity. The solution rank is examined first, and the diversity is considered when the rank cannot determine the superiority of one solution over others. Because higher diversity is more favorable, solutions with higher diversity will survive to the next generation when the same rank is assigned. This process is repeated until the stopping criterion is satisfied.

In this study, any solution that violated the pressure constraint was eliminated from the population set for each generation; new individuals that satisfied the constraint were generated and included in the current population set until the predefined population number was met by the current generation.

STUDY NETWORKS

To investigate the performance of the proposed system robustness formulations, three representative benchmark networks were employed for case studies. The New York tunnels (NYT) network, Hanoi water distribution network (Hanoi WDN), and Gessler (1985) network were newly designed based on the proposed objective formulations (Figure 1).

The NYT system is composed of deep rock tunnels with large diameters (0.914–5.182 m); it has 20 nodes and 21 pipes, including two pipes connected to a single source. The new design for the system was assumed to be based on resizing all pipes (i.e. no rehabilitation or parallel pipe installation). A single demand pattern was considered, and the dataset for available pipe sizes, nodal demand, and pipe length was adopted from Dandy *et al.* (1996). A Hazen–Williams roughness coefficient of $C = 100$ was assigned to all pipes.

Fujiwara & Khang (1990) were the first to design the Hanoi WDN. The system consists of 32 nodes and 34 pipes with only one transmission pipe from a single source. The commercially available pipe diameters are 0.305, 0.406, 0.508, 0.610, 0.762, and 1.016 m. The system

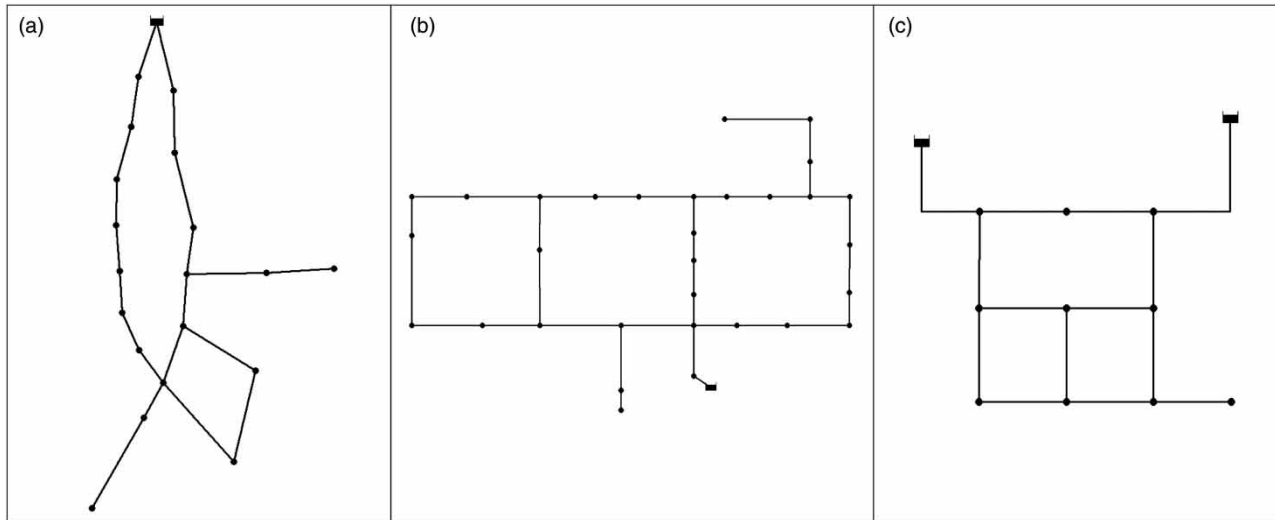

Figure 1 | Layout of three benchmark networks. (a) New York tunnels, (b) Hanoi water distribution network, (c) Gessler (1985) network.

information with regard to the nodal demand and pipe length was taken from Fujiwara & Khang (1990). A Hazen–Williams roughness coefficient of $C = 130$ was assigned to all new pipes.

The Gessler (1985) network is a hypothetical network with two sources. The basic dataset for the system, including available pipe sizes and associated costs, was taken from Simpson *et al.* (1994). All of the pipes were assumed to have C of 120.

Note that the constant α in the pipe cost function (Equation (4)) was 1.1 for both NYT and Hanoi WDN, and the exponential coefficient n was 1.24 for NYT and 1.5 for Hanoi WDN. The minimum pressure requirement of 28.12 m was set as a constraint for NYT and Hanoi WDN, while 17.58 m was set for the Gessler (1985) network.

RESULTS

Three decision criteria were utilized to evaluate the performance of the optimal designs obtained from the proposed system robustness formulations: (1) total sum of nodal robustness values; (2) standard deviation of nodal robustness values; and (3) minimum nodal robustness. Evaluation criterion (1) compares the total system robustness values without considering the spatial distributions, while criterion (2) can be used to evaluate the variation in

nodal robustness values throughout the system. Criterion (3) focuses on the worst robustness value at the critical node of the design, which is of concern to the system designer.

These three criteria were used to evaluate the obtained optimal designs of the benchmark networks. The results should be useful to developing guidelines for selecting an appropriate system robustness formulation with respect to a system layout for a robust WDS design framework.

NYT: Single source and multiple source-connected pipes

Figure 2(a) shows the total sum of nodal robustness values (evaluation criterion (1)) for the Pareto solutions obtained from three formulations. Formulation 2 resulted in values that were three times those of the other two methods. As shown in Figure 2(b), however, the standard deviation of the nodal robustness values (evaluation criterion (2)) of Formulation 2 was much higher than the other methods. The results indicated that the nodal robustness values of the system obtained using Formulation 2 are highly variable throughout the network. As shown in Figure 2(c), the minimum nodal robustness values (evaluation criterion (3)) of the optimal designs by Formulation 2 were much smaller than those of the other methods, which indicates vulnerable solutions. Note that the overall results of Formulations 1 and 3 were similar.

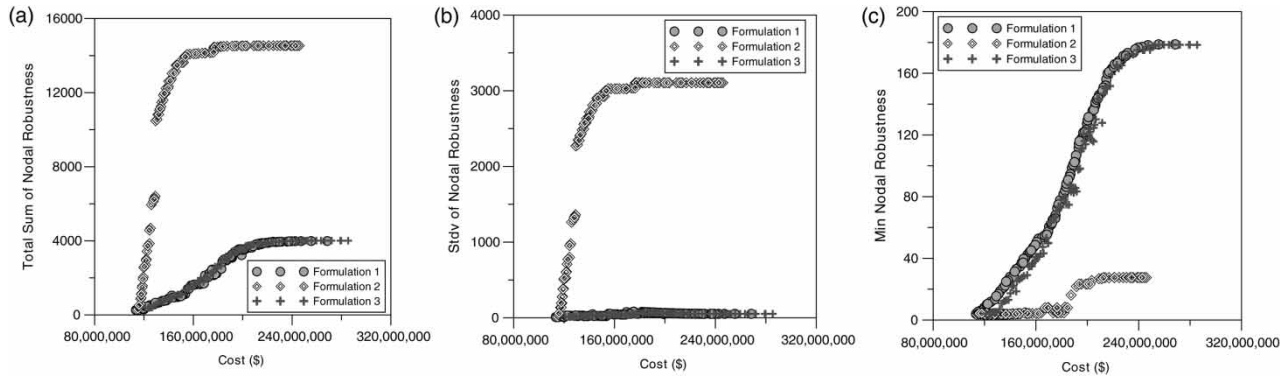

Figure 2 | System robustness evaluation for Pareto solutions of NYT system. (a) Total sum of nodal robustness, (b) standard deviation of nodal robustness, (c) minimum nodal robustness.

For further comparison of the optimal solutions obtained using the proposed formulations, a particular optimal design showing similar system cost (about USD 202M) from each formulation was selected. Table 1 compares the results of the three selected optimal designs. The optimal design from Formulation 2 resulted in a total sum of nodal robustness values (=14,527.25) that was four times that of the other two designs, while the standard deviation in nodal robustness values (=3105.21) was 50 times those of the other two designs. Figure 3 shows the nodal robustness value of each node for the selected designs. The nodal robustness value at node 2 by Formulation 2 was extremely large at 13,938.77, while other nodal robustness values were lower than 100. Thus, Formulation 2 hinders the increase in overall nodal robustness by making a single nodal robustness value at a particular node extremely high.

Node 2 was connected to the source; thus, its mean pressure was high, but the pressure variation was small. Thus, node 2 was utilized to increase the total sum of nodal robustness values in Formulation 2. As shown in Figure 4, pipe 1 was designed to have the largest diameter of 5.182 m, but the downstream pipe 2 was designed to have the smallest diameter of 0.914 m. Thus, water flowed

in the clockwise direction in the main loop. As a consequence, the overall nodal robustness values were low except at node 2. Almost all of the Pareto solutions by Formulation 2 had a similar pipe layout, as explained above. In other words, a total of 72 out of 100 solutions were designed, so pipe 1 had the largest diameter and pipe 2 had the smallest diameter, which resulted in node 2 having the highest nodal robustness. Therefore, Formulation 2 failed to find a robust system since it tended to abnormally increase the nodal robustness at a certain node close to the source if multiple pipes were connected to a single source. Therefore, Formulation 2 tends to increase the total sum of nodal robustness without considering system-wide robustness enhancement.

Hanoi WDN: single source and single source-connected pipe

Hanoi WDN was supplied by a single source via a single transmission line. As seen in Figure 5, no distinct differences were observed among the solutions obtained using the three formulations, except that the solutions by Formulation 2 had slightly lower minimum nodal robustness values than the

Table 1 | Statistics of robustness values of the selected optimal solutions for NYT system

New York tunnels	Total cost (\$)	Min nodal robustness	Sum of nodal robustness values	Sum of critical nodes' robustness values	Mean of nodal robustness values	Stdv of nodal robustness values
Design by Formulation 1	202,183,700	131.84	3,557.60	690.79	187.24	62.58
Design by Formulation 2	202,145,800	23.34	14,527.25	132.27	764.59	3,105.21
Design by Formulation 3	202,291,900	121.87	3,561.15	691.27	187.43	62.92

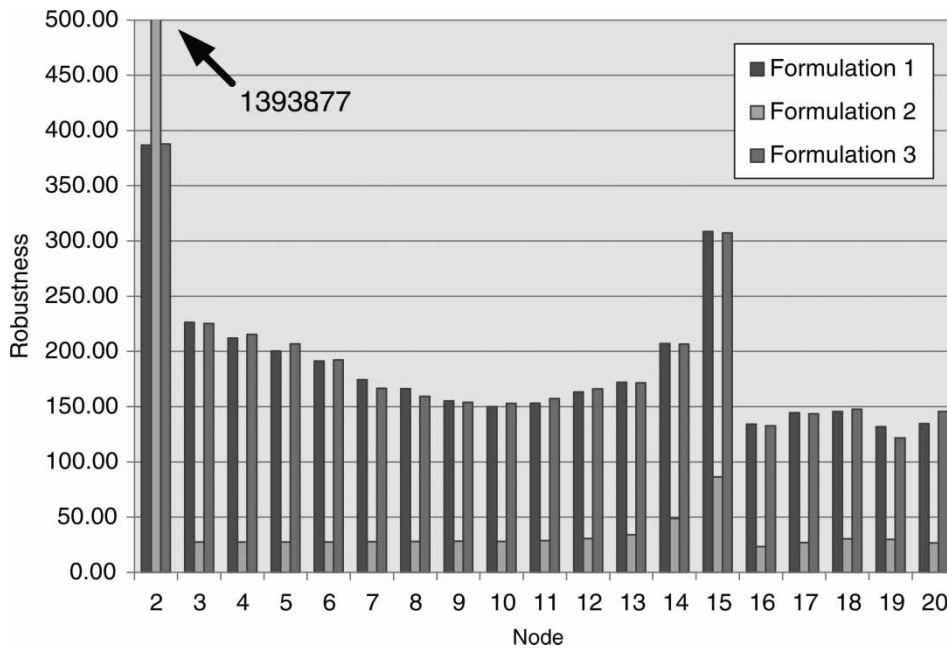

Figure 3 | Nodal robustness of selected optimal solutions (given in Table 1) for NYT.

other methods, as shown in Figure 5(c). Three optimal designs with similar construction costs (about USD 23.2M) were selected from each of the Pareto solutions, and the nodal robustness values were plotted as shown in Figure 6. The overall results of the three selected designs were similar. Note that the Hanoi network supplied water through a single pipe from a single source, which was the main difference with the NYT system. Thus, for this type of network, any of the three proposed formulations can be posed as a robustness objective in a WDS optimization framework.

Gessler (1985) network: uneven nodal elevations with multiple sources

The Gessler (1985) network was located in a sloping area, while other benchmark networks were assumed to have zero elevation for all nodes. Therefore, in most cases (51% of the solutions by Formulation 1, 71% of the solutions by Formulation 2, and 80% of the solutions by Formulation 3), a minimum nodal robustness was observed at node 4, which had the highest elevation, even though it was close to the source.

Three optimal designs with similar construction costs (about USD 5.85M) were selected from each of the Pareto solutions; the nodal robustness values are plotted in Figure 7. When used to increase the minimum nodal robustness at node 4 (dashed circle in Figure 8), Formulation 1 could not effectively increase the nodal robustness at other nodes. Formulation 2 resulted in a large increase in nodal robustness at nodes 2 and 6–12 (solid circles in Figure 8), but it failed to increase robustness at node 4 (critical node). Overall, the optimal design of Formulation 3 was acceptable since it tended to maintain the robustness value at the critical node and increased system-wide robustness values.

Note that the Gessler (1985) network was the only study network with two reservoirs; thus, more redundancy existed in the network. Regardless of the robustness formulations, increasing total sum of nodal robustness values was much more efficient (increase from 53.6 to 780.6, as shown in Figure 9(a)) in the Gessler (1985) network than in the Hanoi WDN (increase from 339.4 to 407.3, as shown in Figure 5(a)).

The system costs of the Pareto solutions by Formulation 1 were lower than USD 6M, as shown in Figure 9 (the highest cost was USD 5,965,672). With Formulation 1, node 4

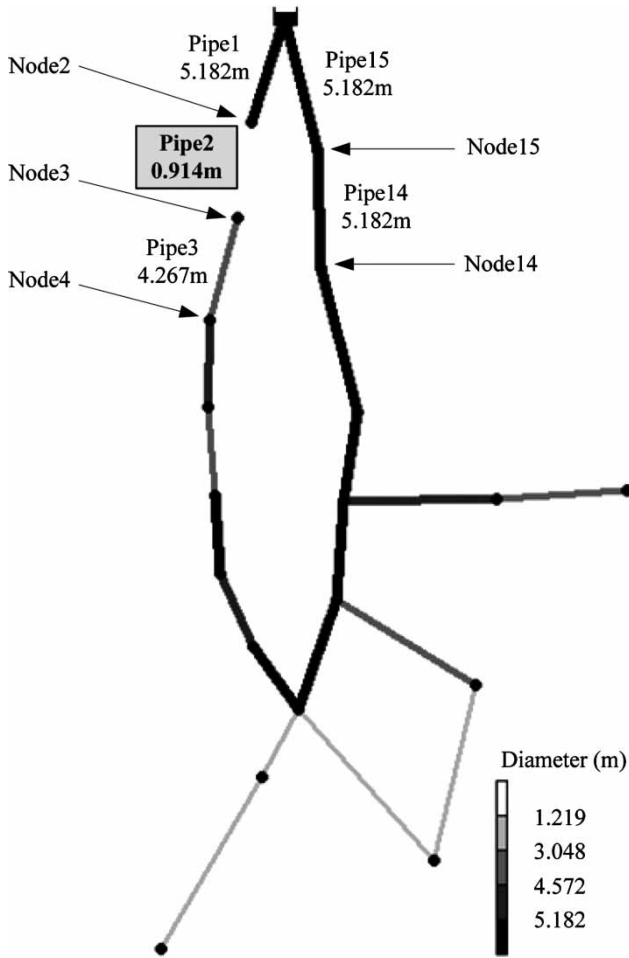

Figure 4 | Pipe design of NYT system by Formulation 2 (USD 202,145,800; statistics of robustness values are given in Table 1).

was always the critical node for designs that cost more than USD 5M. Once the minimum nodal robustness at this location reached a certain value, NSGA-II stopped producing solutions with a higher cost. Therefore, in the Gessler (1985) network, Formulation 1 only focused on increasing the nodal robustness at node 4. Thus, the sum of nodal robustness was much lower than that in other solutions obtained by Formulations 2 and 3 in the cost range of USD 5M–6M as shown in Figure 9(a). However, the minimum nodal robustness values were larger than those of the other solutions, as shown in Figure 9(c).

Therefore, both the minimum nodal robustness and the total sum of nodal robustness should be maximized for this type of network.

SUMMARY AND CONCLUSIONS

When designing a robust WDS against uncertain system conditions, water utilities tend to include system performance measures along with the economic cost. While various system performance measures such as reliability and resilience have been used for the optimal design of WDS, system robustness delivers distinctly different system characteristics. Robustness is generally defined as the ability of a system to maintain its functionality even when perturbations in the system factors occur. Here, system robustness was employed as a design objective to produce

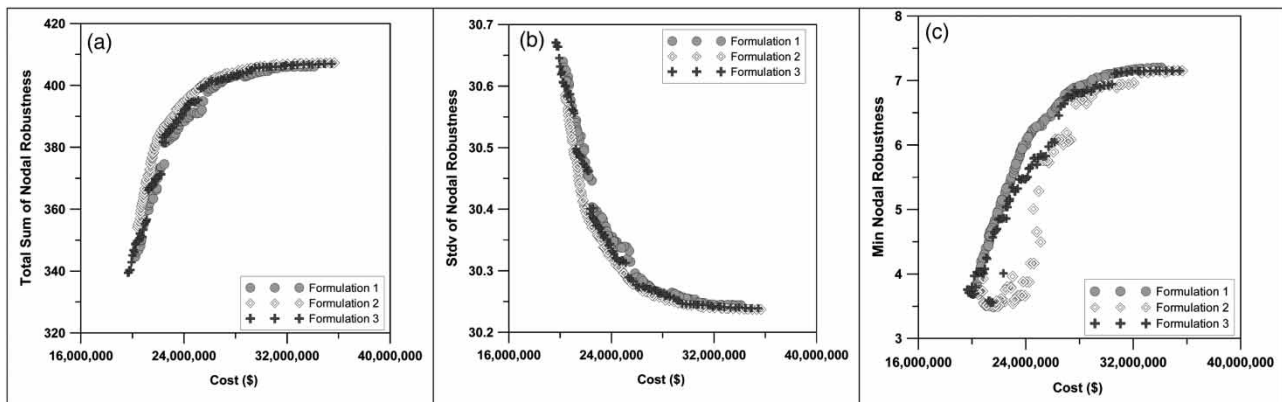

Figure 5 | System robustness evaluation of Pareto solutions for Hanoi WDN. (a) Total sum of nodal robustness, (b) standard deviation of nodal robustness, (c) minimum nodal robustness.

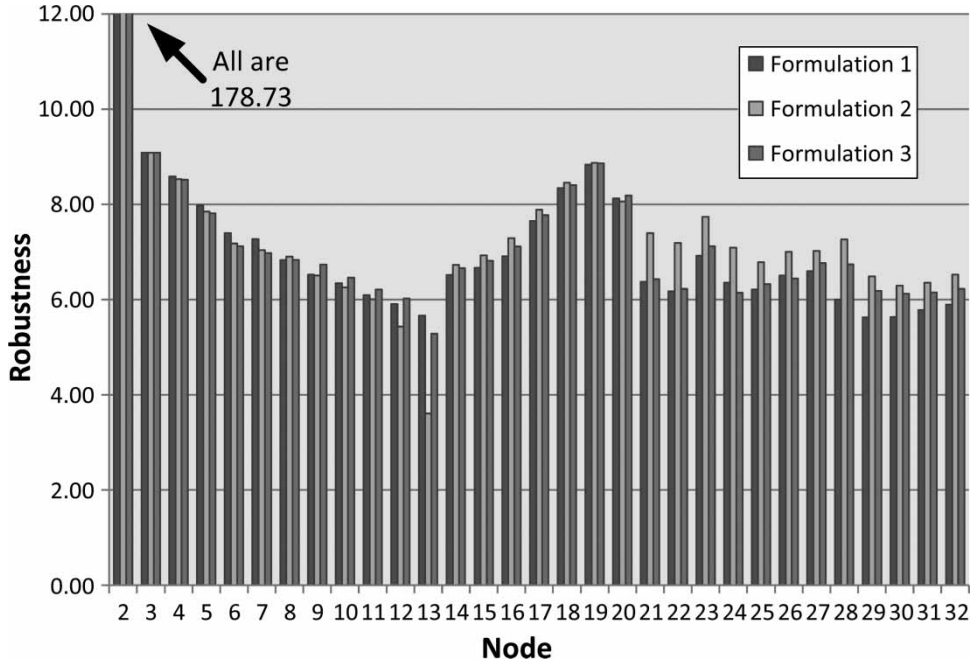

Figure 6 | Nodal robustness of selected optimal solutions for Hanoi WDN.

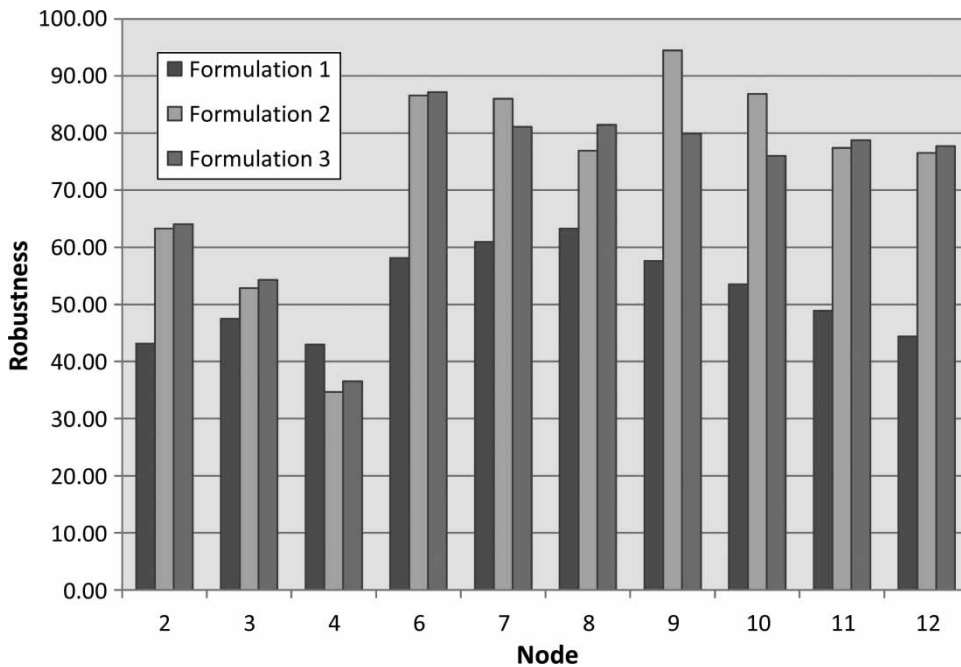

Figure 7 | Nodal robustness of selected optimal solutions for Gessler (1985) network.

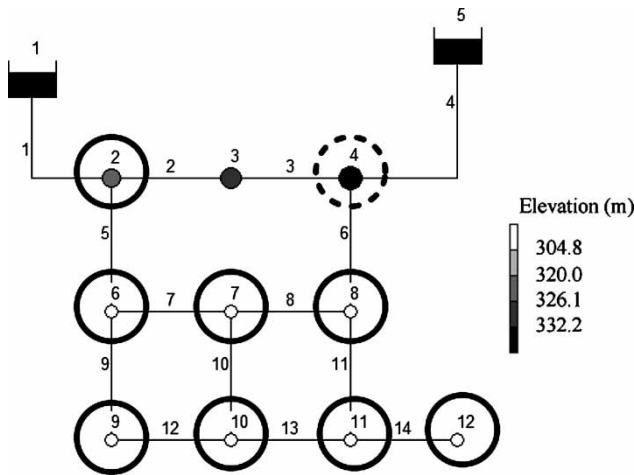

Figure 8 | Critical node (dashed circle) and nodes highly influenced by node 4 (solid circle) in Gessler (1985) network.

a robust system with low variation in its function, i.e. maintaining nodal pressure.

This study investigated three different objective formulations representing system robustness in a WDS optimization framework: (Formulation 1) minimum nodal robustness, (Formulation 2) total sum of nodal robustness, and (Formulation 3) sum of nodal robustness at multiple critical nodes. The goal was to identify the most appropriate formulation to enhance the overall system robustness applicable to a general system layout.

For networks with a single source and multiple source-connected pipes (NYT system), Formulation 2

resulted in an abnormal increase in the nodal robustness at a particular node close to the source; however, this phenomenon was not identified in the single source and single source-connected pipe network (Hanoi WDN) or multiple-source network (Gessler network). Formulation 1 always resulted in optimal designs with the highest minimum nodal robustness, and Formulation 3 tended to produce solutions that compensated for different aspects of Formulations 1 and 2. For the network with uneven elevations, Formulation 1 stopped producing redundant solutions once nodal robustness at the critical node reached a certain value.

While Formulations 1 and 2 have the risk of choosing vulnerable solutions, Formulation 3 seems to reduce the risk of finding vulnerable solutions regardless of the system layout, although the appropriate number of nodes in the critical node group should be decided beforehand. In addition, the optimal design with two robustness objectives of maximizing both the minimum nodal robustness and the total sum of nodal robustness is an alternative approach. By posing two system robustness formulations, more robust solutions can be obtained even after the nodal robustness at the critical node converges. Future study will involve the design of real networks with more diverse robustness formulations and comparison of results with those obtained in this study.

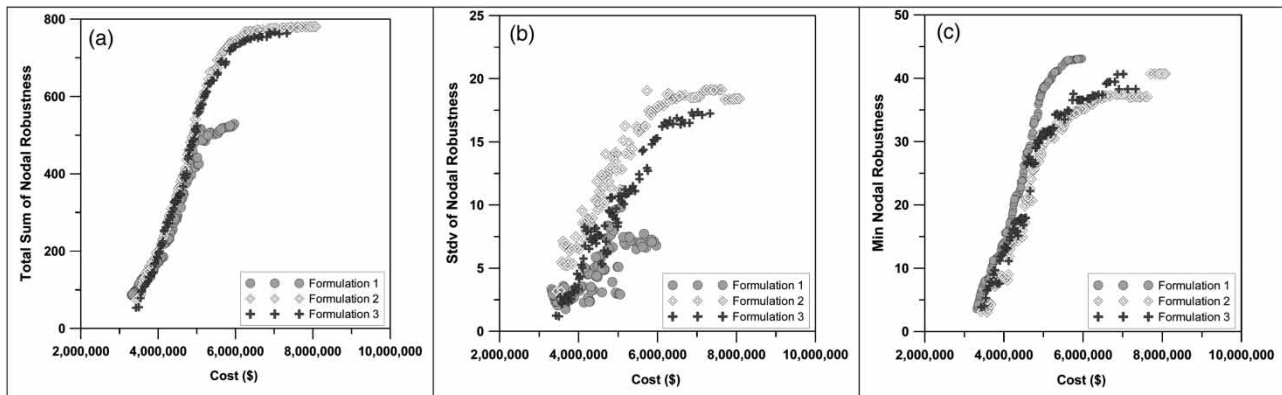

Figure 9 | System robustness evaluation of Pareto solutions for Gessler (1985) network. (a) Total sum of nodal robustness, (b) standard deviation of nodal robustness, (c) minimum nodal robustness.

ACKNOWLEDGEMENTS

This study was supported by the Korea Ministry of Environment as part of the Eco-Innovation project (GT-02-G-1). The authors thank the reviewers for their valuable comments and suggestions that improved the quality of this paper.

REFERENCES

- Alperovits, E. & Shamir, U. 1977 Design of optimal water distribution systems. *Water Resour. Res.* **13** (6), 885–900.
- Babayan, A., Kapelan, Z., Savic, D. & Walters, G. 2005 Least-cost design of water distribution networks under demand uncertainty. *J. Water Resour. Plann. Manage.* **131** (5), 375–382.
- Dandy, G., Simpson, A. & Murphy, L. 1996 An improved genetic algorithm for pipe network optimization. *Water Resour. Res.* **32** (2), 449–458.
- Deb, K., Pratap, A., Agarwal, S. & Meyarivan, T. 2002 A fast and elitist multiobjective genetic algorithm: NSGA-II. *IEEE Trans. Evol. Comput.* **6** (4), 182–197.
- Farmani, R., Walters, G. & Savic, D. 2003 Multi-objective optimization of water system: a comparative study. In: *Pumps, Electromechanical Devices and Systems Applied to Urban Water Management* vol. 1, (E. Cabrera & E. Cabrera Jr, eds). Balkema, Rotterdam, The Netherlands, pp. 247–256.
- Farmani, R., Walters, G. & Savic, D. 2005 Trade-off between total cost and reliability for Anytown water distribution network. *J. Water Resour. Plann. Manage.* **131** (3), 161–171.
- Fujiwara, O. & Khang, D. 1990 A two-phase decomposition method for optimal design of looped water distribution networks. *Water Resour. Res.* **26** (4), 539–549.
- Gessler, J. 1985 Pipe network optimization by enumeration, *Proc. Comput. Appl. Water Resour.* ASCE, New York, USA, pp. 572–581.
- Giustolisi, O., Laucelli, D. & Colombo, A. F. 2009 Deterministic versus stochastic design of water distribution networks. *J. Water Resour. Plann. Manage.* **135** (2), 117–127.
- Goulter, I. 1995 Analytical and simulation models for reliability analysis in water distribution systems. In: *Improving Efficiency and Reliability in Water Distribution Systems* (E. Cabrera & A. F. Vela, eds). Kluwer Academic, London, UK, pp. 235–266.
- Hashimoto, T. 1982 Robustness of water resources systems. *Water Resour. Res.* **18** (1), 21–26.
- Jen, E. 2002 Stable or robust? What's the difference? *Complexity* **8** (3), 12–18.
- Kang, D., Pasha, M. & Lansey, K. 2009 Approximate methods for uncertainty analysis of water distribution systems. *Urban Water.* **6** (3), 233–249.
- Kapelan, Z., Savic, D. & Walters, G. 2005 Multiobjective design of water distribution systems under uncertainty. *Water Resour. Res.* **41** (11), W11407-1–W11407-15.
- Lansey, K. 2012 Sustainable, robustness, resilient water distribution systems. *Proc. Water Distribution System Analysis*. Adelaide, Australia.
- Lansey, K., Duan, N., Mays, L. & Tung, Y. 1989 Water distribution system design under uncertainties. *J. Water Resour. Plann. Manage.* **115** (5), 630–645.
- Lansey, K. & Mays, L. 1988 Optimization model for water distribution system design. *J. Hydr. Eng.* **115** (10), 1401–1418.
- Prasad, D. & Park, S. 2004 Multiobjective genetic algorithms for design of water distribution networks. *J. Water Resour. Plann. Manage.* **130** (1), 73–82.
- Savic, D. & Walters, G. 1997 Genetic algorithms for least-cost design of water distribution networks. *J. Water Resour. Plann. Manage.* **123** (2), 67–77.
- Schaake, J. & Lai, D. 1969 *Linear Programming and Dynamic Programming Applications to Water Distribution Network Design*. Rep. No. 116, Dept. of Civil Engineering, MIT, Cambridge, MA, USA.
- Simpson, A., Dandy, G. & Murphy, L. 1994 Genetic algorithms compared to other techniques for pipe optimization. *J. Water Resour. Plann. Manage.* **120** (4), 423–443.
- Srinivas, N. & Deb, K. 1994 Multiple objective optimizations using non-dominated sorting in genetic algorithms. *Evol. Comput.* **2** (2), 221–248.
- Todini, E. 2000 Looped water distribution networks design using a resilience index based heuristic approach. *Urban Water* **2** (3), 115–122.
- Todini, E. & Pilati, S. 1987 A gradient method for the analysis of pipe networks. In: *International Conference on Computer Applications for Water Supply and Distribution*, Leicester Polytechnic, UK, Sept. 8–10.
- Uber, J., Brill, E. & Pfeffer, J. 1991a Robust optimal design for wastewater treatment. I: general approach. *J. Environ. Eng.* **117** (4), 425–437.
- Uber, J., Pfeffer, J. & Brill, E. 1991b Robust optimal design for wastewater treatment. II: application. *J. Environ. Eng.* **117** (4), 438–456.
- Xu, C. & Goulter, I. 1999 Reliability-based optimal design of water distribution network. *J. Water Resour. Plann. Manage.* **125** (6), 352–362.

First received 19 March 2012; accepted in revised form 9 April 2013. Available online 27 May 2013