

Next-Generation MODIS for Polar Operational Environmental Satellites

CARL F. SCHUELER

Hughes Santa Barbara Remote Sensing, Goleta, California

WILLIAM L. BARNES

NASA/Goddard Space Flight Center, Greenbelt, Maryland

(Manuscript received 14 January 1997, in final form 30 May 1997)

ABSTRACT

The Moderate Resolution Imaging Spectroradiometer (MODIS) protoflight model has been delivered to the NASA Earth Observing System AM-1 platform project to provide highly calibrated, near daily, global atmosphere, land, and ocean observation in 36 spectral channels. MODIS includes extensive in-flight calibration allowing improved environmental data products addressing the visible–infrared imaging Environmental Data Records required by the National Polar-Orbiting Operational Environmental Satellite System. NASA is considering Advanced MODIS concepts to dramatically reduce MODIS mass, power, and volume. Alternatively, next-generation MODIS Light options can substantially reduce MODIS cost, mass, power, and size but retain the core MODIS optical bench assembly spectroradiometric sensing subsystem to minimize both performance risk and changes to the data processing algorithms. These MODIS Light options range from in-flight calibration hardware removal to instrument repackaging and scanner redesign. The simplest modification results in a 17% mass reduction, while scanner redesign results in 40% mass and volume reduction.

1. Introduction

a. MODIS design philosophy

The Moderate Resolution Imaging Spectroradiometer (MODIS) (Barnes and Salomonson 1993) for NASA's Earth Observing System (EOS) (King et al. 1995) was designed to meet requirements listed in Table 1. These requirements were developed in the early 1990s for an EOS mission whose basic thrust centered on long-term (15 years) monitoring of global environmental change. Critical among these requirements was data intercomparability among parallel and sequential flights. Data intercomparability dictated extensive on-orbit calibration, as well as preflight calibration and characterization, high-quality components and facilities, careful development, and attentive manufacturing and testing.

The resulting design illustrated in Fig. 1 incorporates five state-of-the-art radiometric calibration subsystems: a high-emissivity blackbody, a solar diffuser, a solar diffuser stability monitor (SDSM), a spectroradiometric calibration assembly (SRCA) that also measures spectral band location and registration, and a space-view port for deep-space and lunar calibration. To accommodate

frequent infrared calibration (every 1.47 s), a 360° rotating paddle-mirror is centered within a scan cavity to provide the optical subsystem with sequential views of the five calibrators and the earth. About two-thirds of the instrument volume comprises the scan cavity required to house the paddle-mirror and calibrators. The first flight unit (denoted “protoflight”) is scheduled to be launched on the EOS AM-1 spacecraft in June 1998 and is shown in Fig. 2 (Pagano et al. 1996). The second flight unit (denoted “flight model 1”) is under construction for a summer 1998 delivery.

b. MODIS operational products

With 36 calibrated spectral channels, MODIS (Barnes and Salomonson 1993; NASA 1996) includes improved visible–infrared imager capability, and some of the infrared sounder capabilities, of the Department of Commerce (DOC) National Oceanic and Atmospheric Administration's (NOAA) Polar Operational Environmental Satellites (POES) (UCAR 1991), as well as additional ocean imaging capability. MODIS will offer calibrated spectral measurements improving on the POES Advanced Very High Resolution Radiometer (AVHRR), including the new AVHRR/3 1.6- μm cloud/snow discrimination channel. MODIS includes two-thirds of the POES High Resolution Infrared Sounder (HIRS) spectral bands (Kidder and Vonder Haar 1995, 99). MODIS also offers ocean-color measurements (Ab-

Corresponding author address: Dr. Carl F. Schueler, Hughes Santa Barbara Remote Sensing, Mail Stop B32-73, 75 Coromar Drive, Goleta, CA 93117.
E-mail: cfschueler@ccgate.hac.com

TABLE 1. MODIS requirements and key design features.

Design requirement	Achieved by
6-yr life	360° scan with radiative cooling
Low 1/f noise	Space and blackbody views with each scan
High sensitivity	Unobscured optics, low-noise detectors
Low near-field response	Low-scatter, spectrally optimized coatings
Optimized spectral profiles	Individual dielectric filters per band
Excellent out-of-band rejection	Distributed blocking over multiple surfaces
Band-specific dynamic range and SNR	Individual preamplifiers for each band
20% coregistration of all bands	Zero coefficient of thermal expansion, graphite epoxy, and Be structures, and onboard processing
Unprecedented calibration accuracy	Five onboard calibration subsystems



FIG. 2. MODIS Protoflight Model (first MODIS flight unit for EOS AM-1). Radiative cooler faces camera with scan mirror on the lower right.

bott and Chelton 1991), previously demonstrated by the Coastal Zone Color Scanner, but not offered by POES.

These observations suggest that MODIS may address the requirements of the new National Polar-Orbiting Operational Environmental Satellite System (NPOESS), which is converging the Defense Meteorological Satellite Program (DMSP) and the NOAA POES program [NPOESS Integrated Program Office (IPO) 1996]. Sixty-one Environmental Data Records (EDRs) define the NPOESS requirements in terms of geophysical measurement parameters. The NPOESS IPO has assigned 26 EDRs to the NPOESS Visible-Infrared Imaging Radiometer Suite (VIIRS), and three to the Cross-Track Infrared Sounder (CrIS) component of the NPOESS Cross-Track Infrared/Microwave Sounder Suite (CrIMSS). MODIS addresses the VIIRS EDRs, except for

the nighttime visible imagery requirement. MODIS also acquires data relevant to CrIS EDRs.

The 26 VIIRS EDRs and three CrIS EDRs are summarized in Table 2, with a qualitative comparison of POES AVHRR/HIRS and MODIS performance, where "partial" indicates the EDR can be computed, but at less than the NPOESS fidelity requirement. Each EDR is numbered in order relative to the other VIIRS EDRs in the NPOESS IPO Technical Requirements Document, available at the referenced NPOESS IPO internet site. EDRs depend upon algorithms, instruments, and varied ancillary data, so that quantitative EDR fidelity assessment is not possible based solely on instrument data character. AVHRR/HIRS and MODIS data character, however, provide a basis for relative comparison. While

MODIS Parameters

- Orbit: 705 km Polar Sun-Synchronous
- Scan: Cross-track
- Swath: 2330 km
- Resolution:
 - 250 m (bands 1-2)
 - 500 m (bands 3-7)
 - 1 km (bands 8-36)
- Mass: 220 kg
- Data Rate: 11 Mbps
- Power: 160 watts

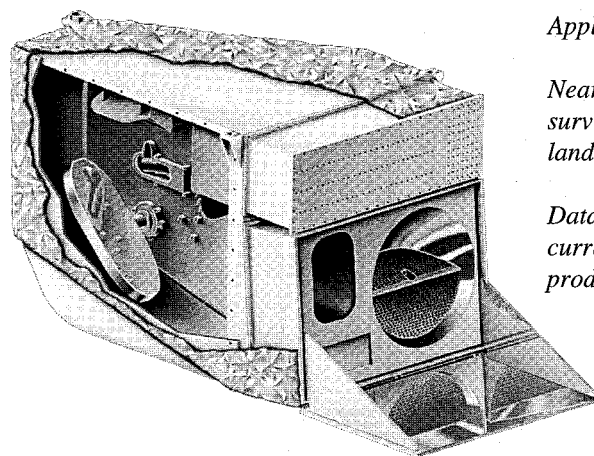

Applications

Near-daily global survey of atmosphere, land, and ocean

Data Products include all current POES derived products and more.

FIG. 1. MODIS artist's conception shows 360° scan mirror required to view multiple onboard calibration systems as well as the earth scene below.

TABLE 2. POES/MODIS performance to NPOESS EDRs.

NPOESS VIIRS (1–26) and CrIMSS IR Sounder Environmental Data Records	POES AVHRR/HIRS	MODIS (Predicted)
Atmospheric parameters		
(1) Imagery horizontal spatial resolution	Does not meet	Improves*
Aerosol (4) optical thickness and (5) particle size	Partial	Meets
(6) Suspended matter	Partial	Improve
Cloud (7) base height and (8) cover layers	Partial	Improve
Cloud (9) effective particle size, and (10) optical depth	Partial	Meets
(11–13) Cloud-top height, pressure, and temperature	Partial	Improve
CrIS vertical moisture/pressure/temperature profiles	Partial	Partial (less)
Land parameters		
(3) Soil moisture, surface (14) albedo, and (18) type	Partial	Improve
(15) Land and (21) ice surface temperature	Partial	Meets
(16) Normalized difference vegetation index	Meets	Improve
(17) Snow cover and depth	Partial	Improve
Ocean (or freshwater) parameters		
(2) Sea surface temperature/(19) ocean currents	Meets/partial	Improve
(20) Freshwater ice edge motion	Partial	Improve
(22) Littoral sediment transport and (26) turbidity	Partial	Improve
(23) Net heat flux	Partial	Improve
(24) Ocean color and chlorophyll	No data	Meets
(25) Sea ice age and edge motion	Partial	Improve

* Can further improve with focal plane and data processing modifications.

MODIS does not meet the imagery horizontal spatial resolution (HSR) illustrated in Fig. 3, it could with focal plane and electronic modifications, further discussed in the next section.

While POES currently provides most of the data products represented in Table 2, MODIS offers radiometric calibration and added spectral bands to improve product fidelity. For example, MODIS is expected to allow sea surface temperature to be measured to better than 0.4 K compared to the AVHRR's 0.5–0.7 K (Brown 1996), and POES total precipitable water vapor estimates are expected to improve from 20% uncertainty to 7% with MODIS data (King et al. 1992).

Global atmospheric EDRs that MODIS will address include aerosol particle size, cloud detection and mapping, cloud-top altitude and temperature (Kaufman and Gao 1992; King et al. 1992), and vertical temperature profiles (Menzel and Gumley 1994). POES HIRS provides 1.3° (18.5 km at nadir from 833-km altitude) spatial resolution vertical temperature sounding in 15 channels, discretely sampled at 1.8° (31.4 mrad) increments over ±49.5° cross track (Kidder and Vonder Haar 1995, 98). While fewer in number, the nine MODIS sounding channels compensate with 1-km nadir spatial resolution from 705-km altitude sampled at 1.2-mrad increments over ±55° cross track. Land EDRs MODIS addresses include improved normalized difference vegetation index (NDVI) (Huete and Liu 1994; Liu and Huete 1995), land-surface temperature (Dozier and Wan 1994), as well as snow and ice cover (Running et al. 1994; Hall et al. 1995). MODIS will also offer improved fire-detection capability (Running et al. 1994).

Several products will be new or substantially im-

proved with MODIS and will address NPOESS EDRs. Such atmospheric products include cloud effective particle size, optical thickness, and thermodynamic phase (King et al. 1992). In addition to improved NDVI, improved or new land products will include surface reflectance (Wanner et al. 1995; Vermote 1996), cover type (Strahler et al. 1995), and leaf-area indices (Running et al. 1994). Finally, the MODIS ocean products (Abbott et al. 1991), including fluorescence estimation (Letelier and Abbott 1996), are improved or new. Ocean color, net primary productivity (Lee et al. 1996), and chlorophyll-a concentration (Carder et al. 1998) are expected to meet the ocean color/chlorophyll EDR.

c. Straightforward MODIS modifications can improve horizontal spatial resolution

The NPOESS VIIRS HSR is defined as the footprint dimension corresponding to half the inverse of the spatial frequency where the sensor Modulation Transfer Function is equal to 0.5 (NPOESS IPO 1996). MODIS has the appropriate spectral bands for visible day and IR night imagery, but the current configuration does not offer the required resolution.

The DMSP Operational Line-Scanning System (OLS) produces a 2.7-km resolution “smoothed” data product otherwise known as “constant resolution.” The current DMSP Block 5 OLS offers a raw data cross-track HSR (per the NPOESS definition above) that varies from about 550 m at nadir to about 1.3 km at ±56.5° edge-of-scan. The digitally “smoothed” 2.7-km constant resolution product is created via onboard data processing (Allison and Schnapf 1983, 667; Kramer 1994, 67). This

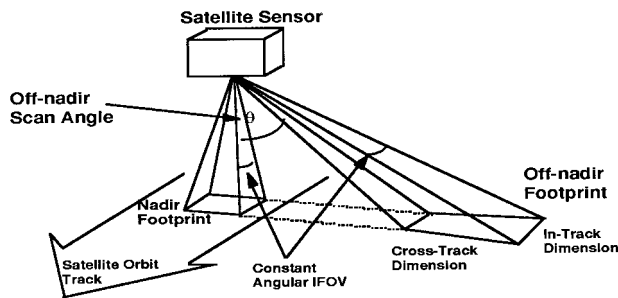

FIG. 3. The NPOESS day/night cloud imagery horizontal spatial resolution (HSR) requirement sets in-track and cross-track HSR at 400 m nadir and 800 m at $\theta = 56.5^\circ$.

compares to an AVHRR cross-track footprint dimension variation from 1.1 km at nadir to 6.4 km at the edge-of-scan (55.3°) (Kidder and Vonder Haar 1995, 91), so that OLS offers a constant resolution product that strikes a balance between AVHRR nadir and edge-of-scan resolution. NPOESS requires improved resolution, which MODIS can meet with detector and readout modifications.

MODIS optics are capable of about 100-m nadir resolution (from a 705-km orbit) in the visible, near-IR, and shortwave IR bands. MODIS is diffraction-limited at longwave IR and offers about 125-m resolution at nadir in the longest-wave NPOESS imager band. MODIS is therefore capable of meeting the NPOESS HSR requirement if appropriate detectors and processing are employed. Modifications would require nonrecurring engineering (NRE) investment, but the NRE should be less than the investment required to develop a new NPOESS imager.

2. MODIS follow-on options

NASA and the NPOESS IPO are interested in a smaller MODIS. The MODIS follow-on objectives include physical mass reduction, and lower cost and risk. Goals and approaches are as follows.

- Reduce spacecraft resource requirements and launch mass:

- delete SDSM and SRCA;
- repackage instrument and reduce electronics to cut mass, power, and volume.
- Reduce instrument recurring and NRE costs:
 - where possible, use existing ground support equipment and existing or minimally modified MODIS subsystem designs to cut NRE;
 - recycle MODIS documentation, test procedures, drawings and software to conserve both NRE and recurring costs.
- Retain key performance characteristics to minimize data product algorithm modifications:
 - retain solar diffuser and blackbody in-flight calibrators and the space-view port;
 - maintain spectroradiometry by retaining the optical bench assembly (OBA) including the telescope, dichroics, and focal plane assemblies (FPAs).

Net program savings can be achieved by design changes that result in lower MODIS recurring cost than the current design to offset NRE incurred by the changes. Overall mission cost will be further reduced as MODIS mass and volume reductions cut spacecraft and launch costs. To accommodate mission requirements uncertainty, MODIS follow-on options cover a configuration range from minimum redesign to minimum mass and volume. Options that avoid dramatic redesign are generically termed "MODIS Light," while options that employ extensive redesign are termed Advanced MODIS (AMODIS).

Specifically, MODIS Light is defined as any redesign that cuts mass without substantially modifying the core spectroradiometric sensing subsystem. Conversely, AMODIS refers to any MODIS redesign that replaces the core spectroradiometric sensing subsystem with redesigned sensing apparatus, such as pushbroom wide field-of-view (WFOV) optics and associated detection assemblies. AMODIS requirements are listed in Table 3, along with comments indicating how these can, in principle, be met by MODIS Light or AMODIS.

The core MODIS subsystem to be retained by MODIS Light is the optical bench assembly (OBA). This subsystem comprises all MODIS sensing apparatuses from

TABLE 3. Preliminary Advanced MODIS requirements.

Advanced MODIS requirement	MODIS Light approach	AMODIS approach
Ensure data continuity	MODIS optics	By design
Preserve band registration	MODIS optics	Pushbroom
1% absolute IR calibration	No modification	TBD
Onboard radiometric calibration	Retain solar diffuser, blackbody	TBD
Enhance out-of-band rejection	No modification	TBD
Remove pixel overlay	Flight S/W modification	By design
Enhance stray-light rejection	Fewer scattering surfaces	Few surfaces
Minimal onboard calibration	Delete SDSM and SRCA	Omit in design
Command/data operations on S/C	Easily separable	By design
Allow mechanical cryocoolers	Can be accommodated	By design
Allow new spectral bands	Space available	WFOV optics
Cut mass, power, and volume	Options cut up to 40%	Pushbroom

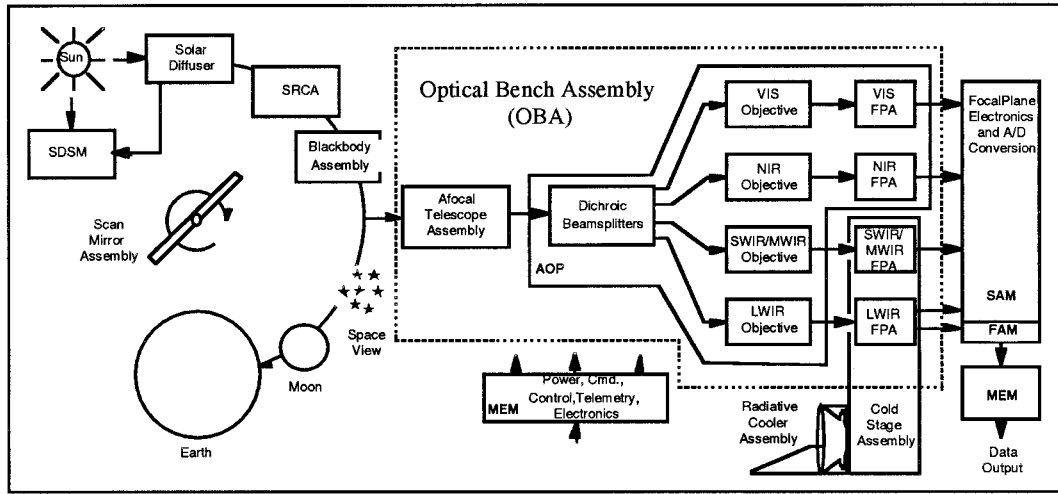

FIG. 4. The Optical Bench Assembly comprises the afocal telescope, the refractive objectives, focal planes, and radiative cooler.

the entrance aperture to the detectors, as illustrated in the block diagram in Fig. 4. The scan subsystem provides input from the earth scene as well as the various in-flight calibration subsystems illustrated. The OBA afocal telescope directs a collimated beam to a set of refractive imaging optics, which further direct the focused light to four FPAs containing 36 independent detector arrays (nine on each FPA). The radiative cooler for the IR FPAs could be replaced by an active mechanical cooler. The OBA hardware is shown in Fig. 5. The OBA design was driven by three key require-

ments: spectral coverage, band registration, and radiometric sensitivity. Many MODIS bands spectrally overlap yet require different radiometric performance. This requirement, coupled with the necessity for spectral purity, is accommodated by simply defining each spectral band with an independent interference filter and detector array. The OBA design, tuned for the MODIS requirements, characterizes MODIS data. Unaltered OBA retention as the core of MODIS Light both minimizes NRE and ensures data continuity to minimize or eliminate

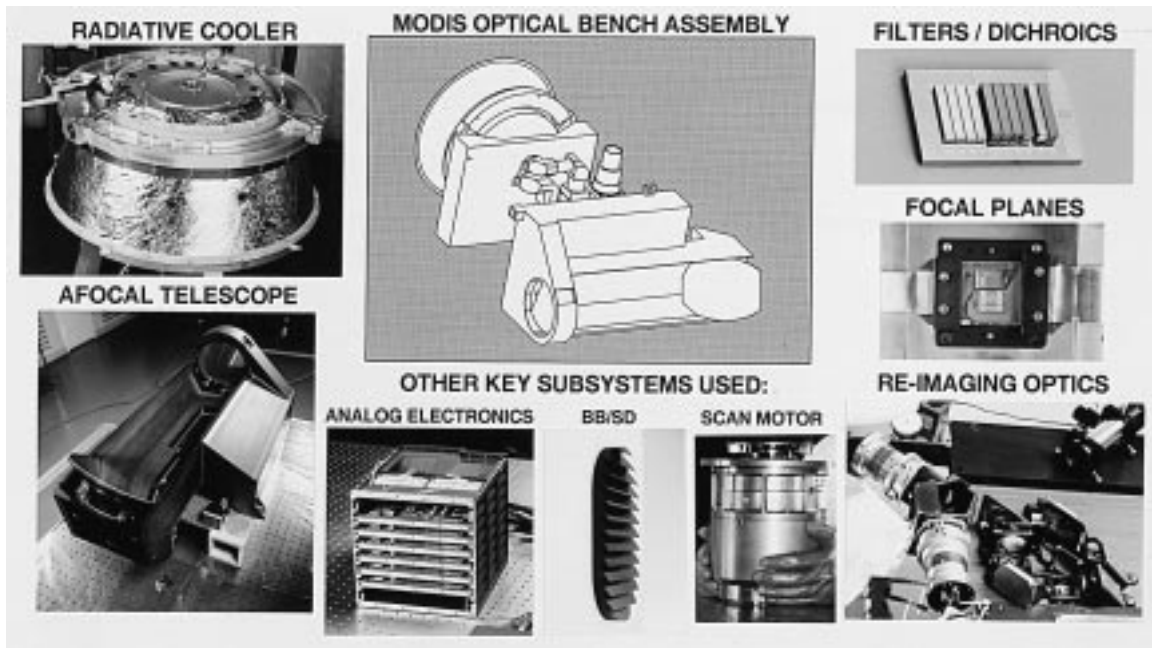

FIG. 5. The Optical Bench Assembly includes the majority of the optical hardware required for the next-generation MODIS. Additional applicable MODIS hardware includes the analog electronics, onboard blackbody, solar diffuser, and scan motor encoder.

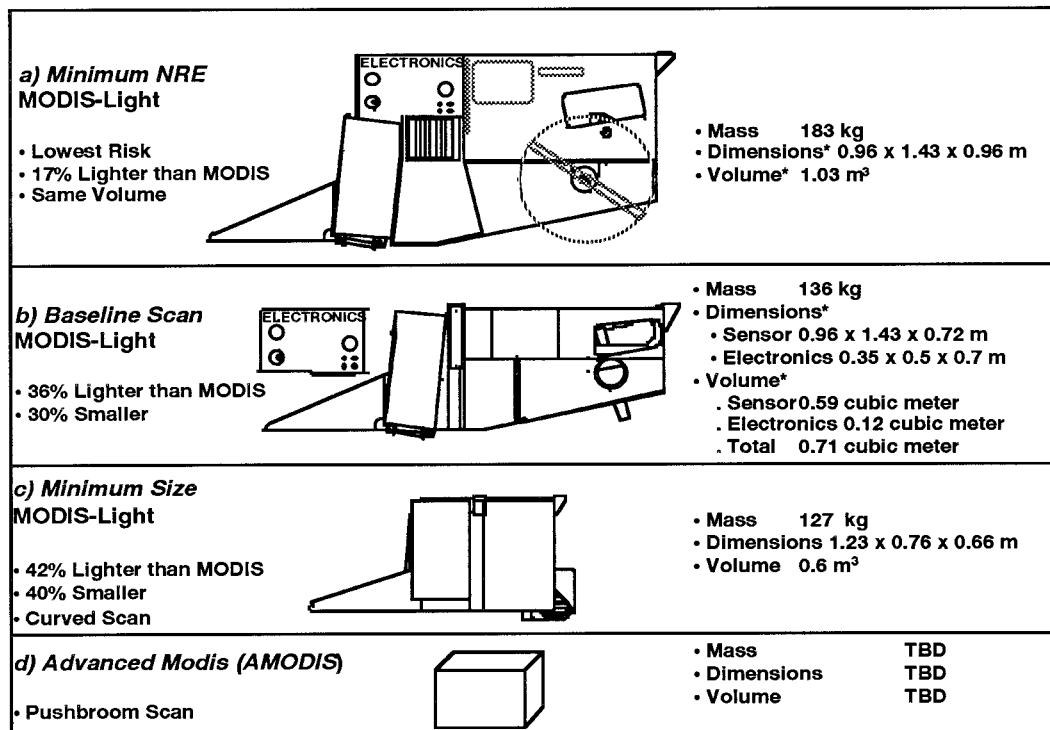

FIG. 6. Four MODIS follow-on options considered. (*Dimensions of a rectangular box that could enclose the instrument in the launch configuration. Actual exterior volume is listed.)

changes to the MODIS data processing algorithms. As shown in Fig. 5, the OBA contains all the key sensing elements in one relatively compact package—in essence, the OBA *is* MODIS. The scan system, onboard calibrators, mainframe, cryogenic cooler, and large portions of the electronics can be modified with only minor impact on the basic data character because the OBA defines the data character.

The MODIS follow-on configurations considered here include three MODIS Light options to repack the OBA and AMODIS. These four cases are illustrated in Fig. 6.

- Minimum NRE MODIS Light (17% lighter)—remove SDSM, SRCA, and associated electronics, without other modifications.
- Baseline scan (reduced mass and volume) MODIS Light (38% lighter, 30% smaller)—mainframe redesign and separate electronics module.
- Minimum size (maximum NRE) MODIS Light (42% lighter, 40% smaller)—scan subsystem redesign, mainframe, and electronics repackaging to minimize mass and volume.
- Advanced MODIS (TBD% lighter and smaller)—WFOV pushbroom scan—several proprietary pre-Phase A design concepts have been proposed.

Each of these cases is discussed in turn and compared. Each MODIS Light option contains solar diffuser and blackbody calibration.

a. Minimum NRE MODIS Light

The simplest and lowest cost MODIS Light design option is to remove the SDSM, the SRCA, and the associated electronics and cabling. This results in a 37-kg mass reduction, as well as a power reduction to 100 W. This option requires the same spacecraft mounting surface area and launch vehicle fairing clearance as the EOS AM-1 instrument, but at low risk. It could, for example, be used immediately to reduce MODIS mission cost while developing a new design.

b. Baseline scan MODIS Light

About an 80-kg mass reduction and a 30% volume reduction can be achieved by removing the electronics from the instrument shown in Fig. 6a and shrinking the mainframe after the SDSM and SRCA have been removed. The result is shown in Fig. 6b and in perspective view in Fig. 7, with the size reduction mostly in the nadir dimension. The mounting surface area required is slightly reduced, and the reduction in the nadir dimension from 1 m to 72 cm allows a smaller launch vehicle fairing. The total mass of 140 kg includes the separate electronics module, which need not be placed close to the instrument.

This approach still preserves the basic instrument design. The cross-track dimension is reduced by about 20 cm by shrinking the scan mirror slightly and moving it

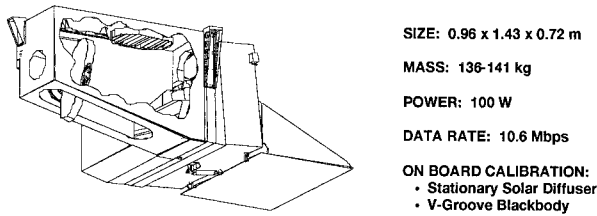

FIG. 7. Baseline scan MODIS Light option preserves baseline paddle-wheel scan, as well as blackbody and solar diffuser (top) and space view.

closer to the aperture. This may require reducing the aperture from 7 to 6 in., affecting radiometric performance, but the instrument has signal margin to meet the radiometric requirements with the reduced aperture. Short of changing the basic scan design, this represents the minimum mass and volume MODIS Light.

c. Minimum size MODIS Light

Removal of the SDSM and SRCA allows scan re-design and 40% instrument volume reduction. Figure 6c shows the cross-track dimension reduced by 50%. Figure 8 shows this option in perspective, with the redesigned scanner on the right. The key to the volume reduction is the placement of a tilted paddle-mirror directly in front of the OBA telescope aperture. Tilting the mirror as shown in Fig. 8 directs light from nadir horizontally into the OBA, and paddle-mirror rotation about an axis parallel to the mirror surface both provides the cross-track scan and allows close proximity to the OBA, while also allowing a compact blackbody calibrator and solar diffuser configuration.

The tilted scan mirror slightly increases instrument sensitivity to polarization, reducing margin relative to the NASA MODIS project polarization sensitivity specification. The tilt produces a 104° rotation of the earth scene relative to the current OBA optical axis, but optical objectives and stops, as well as FPAs, can be rotated to compensate. Scan-mirror tilt relative to the optical axis also produces scan curvature and image ro-

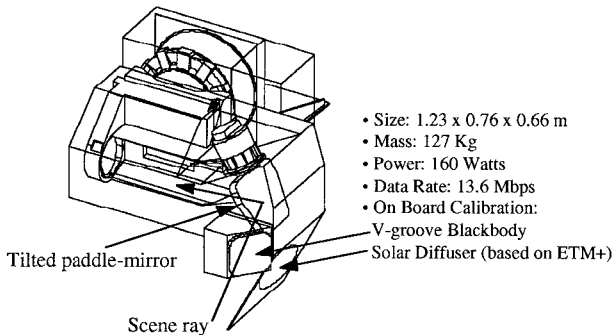

FIG. 8. Minimum size is attained by redesigning the scan subsystem, as shown on the right. A tilted paddle-mirror directs scene energy into the OBA aperture.

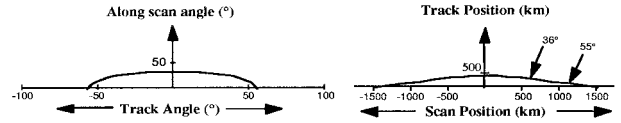

FIG. 9. Minimum size MODIS Light tilted scan mirror produces a curved scan.

tation on the earth, as illustrated in Fig. 9. The scan curvature produces more samples per scan line than a straight-line scan, increasing data rate by 20%. The curved scan and image rotation match, however, so that the scan is always normal to the detector arrays, and band registration is preserved, as illustrated in Fig. 10, for three selected scan angles.

An approximately straight-line level-zero (raw data) scan output could be obtained via onboard interscan data reformatting is illustrated in Fig. 11. By storing sequential scans in buffer memory, the data formatter can be programmed to combine pixels from sequential scans into a single straight scan. The dotted line represents the sampling algorithm to select appropriate pixels from sequential curved scan lines, starting with scan line 1 at nadir, and ending with scan line *k* at the edge of scan.

d. Advanced MODIS

AMODIS design approaches do not retain the MODIS OBA design. Several organizations, including Hughes SBRS, TRW, Orbital Sciences Corporation, NASA/Goddard Space Flight Center (GSFC), and the Jet Propulsion Laboratory, have provided GSFC with proprietary pre-Phase A design concepts to realize “MODIS-like” data with small instrument packages to address the draft set of MODIS follow-on requirements listed in Table 3. All dramatically reduce the instrument mass and volume but are immature in engineering definition and performance assessment compared to MODIS or any of the MODIS Light options.

Two design features appear to be common to all the AMODIS concepts: compact processing electronics to reduce mass and power and WFOV optics to eliminate scanning. Reduction of electronics mass and volume can be accommodated in the current MODIS by repackaging the MODIS electronics design with available high-density (such as three-dimensional) packaging techniques. Therefore, electronics repackaging is not a discriminator for AMODIS compared to MODIS Light, so that WFOV optics represents the key AMODIS conceptual discrim-

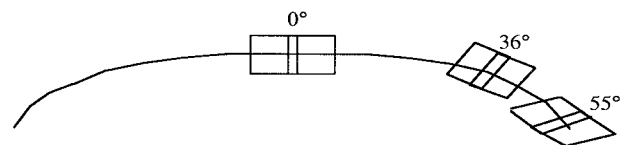

FIG. 10. Footprint rotation with scan is illustrated for three different scan angles. Two adjacent overlapping pixels (scan direction) are shown in each case.

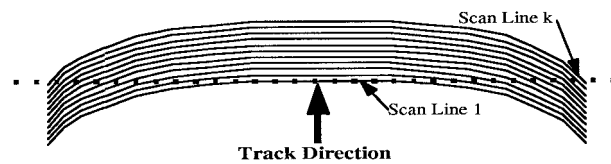

FIG. 11. Straight-line scan output via onboard data reformatting is illustrated by the dotted line, which represents a simple interscan sampling algorithm.

inator. Table 4 summarizes how some of the performance parameters of Table 3 may be affected by a WFOV approach. Each of these parameters is discussed in turn starting with radiometry to point to some key issues that NASA should address during a planned GSFC AMODIS Phase A conceptual definition study.

1) RADIOMETRIC ISSUES

Infrared calibration is handled by MODIS through frequent (each scan) space and blackbody views. The narrow field angle allows a relatively small calibration target, easing the ability to meet uniformity requirements on the target. WFOV systems suffer on both counts. Not only is a large target needed, which makes uniformity more difficult to attain, but the optical system must be calibrated by blocking the earth scene. This can be done with a pointing mirror that alternately views the earth and the calibrator. As avoiding pointing or scanning subsystems is a major reason one might use a WFOV optical design, another approach is to actuate a calibrator in front of the optics. Either approach interrupts scene viewing, causing a loss of desirable mission data.

Moreover, WFOV sensor calibration cannot be as frequent as for a scanned sensor. One result of infrequent calibration is increased uncertainty regarding system radiometric drift. A source of such drift is noise whose amplitude increases with decreasing frequency, known as “ $1/f$ ” noise. Noise at frequencies lower than the

calibration frequency is eliminated. The $1/f$ noise creates noticeable “striping” in images created with the data from infrequently calibrated sensors, and $1/f$ noise has been shown to be low in MODIS based on the once-per-scan calibration.

Stray light rejection at the level required of MODIS is difficult but is manageable because a narrow-field system allows the use of a small two-dimensional optical field stop at an intermediate focus. This is a key part of the overall stray-light rejection strategy used in the MODIS optical bench assembly, in addition to black painted surfaces, baffles, and other conventional stray-light rejection methods. In general, the divergent rays associated with a WFOV system make stray-light rejection more difficult, but the fact that one is limited to essentially a one-dimensional optical field stop worsens the situation.

Spectroradiometric *tunability*, or tailorable sensitivity and dynamic range in each spectral band, is critical as each MODIS spectral band is defined both spectrally and radiometrically. Moreover, half the MODIS spectral bands, each defined spatially by a specific detector array, overlap spectrally with other bands, each defined by a different detector array, that require different dynamic range and sensitivity. For example, bands 4 and 12 overlap spectrally. While band 4 addresses cloud and land properties and requires high dynamic range and modest sensitivity, band 12 addresses ocean color and requires very high sensitivity. Bands 21 and 22 have the same spectral coverage, but have different applications, requiring one band to offer high dynamic range and low sensitivity, and the other low dynamic range and higher sensitivity. There are many other examples.

MODIS handles this overlap in a simple, effective manner. Each spectral band is spatially and spectrally defined by an independent detector array and interference filter. Optimization of detector gain and offset, as well as spectral definition, can be easily accommodated.

WFOV spectrometers using gratings, prisms, or linearly variable interference filters must employ band syn-

TABLE 4. MODIS and WFOV AMODIS performance issues.

Parameter	MODIS/MODIS Light	WFOV AMODIS
Radiometric		
Infrared calibration	Allows frequent calibration Small calibration target	Scene obstructed; $1/f$ noise Requires large, uniform target
Stray light	Low using 2D field stop	Field stop limited to 1D
Tunability*	Individual array per band	Bands share detectors—High-gain applications penalized
Spectral		
Bandpass shape	Tailored bandshapes	Requires band synthesis
Purity	Individual filters fed by distributed blocking	More difficult to maintain constant center λ across FOV; difficult out-of-band rejection
Spatial uniformity		
	Full-field uniformity Few detectors eases calibration	WFOV edge distortion More difficult calibration

* MODIS has multiple overlapping bands with application-specific radiometry.

thesis to create the irregularly sized and spaced MODIS spectral bands from regularly spaced, contiguous spectrometer bands. Band synthesis forces a critical compromise in spectral band radiometric fidelity. Two overlapping bands that share detectors cannot be independently radiometrically tuned for different dynamic range and sensitivity requirements. Instead, the detectors and readouts must cover the dynamic range associated with the spectral band requiring the highest dynamic range. The other band will have excessive dynamic range and will suffer a loss of sensitivity margin.

2) SPECTRAL ISSUES

Bandpass width is dictated by MODIS applications. Use of individual arrays for each band with custom-tailored interference eases implementation. Custom bandpasses must be synthesized from narrow contiguous spectrometer channels, as mentioned above.

Spectral purity includes both spectral bandpass uniformity over the length of the detector array and spectral out-of-band rejection. Uniformity is easier to attain in a narrow-field system due to the smaller spectral filters. Longer WFOV filters are more difficult and expensive to control. Spectral out-of-band rejection is also more difficult to attain for a grating, prism, or “wedge” spectrometer, as the blocking filter design has to handle a wide wavelength range. Individual detector arrays with discrete filters allow tuned specific waveband blocking, making out-of-band rejection easier and less expensive to attain.

3) SPATIAL UNIFORMITY

Uniformity of response across the swath is easier and less expensive to attain in a narrow field scanning system. Less ray divergence means less spectral band shift over the spatial field and smaller divergent ray cone MTF degradation effects. A narrow field also allows fewer detectors and inherently more uniform radiometric response over the scan range.

A narrow FOV system, with fewer detectors, is easier and less expensive to calibrate than a WFOV system with many detectors. Electronics grow in complexity and power with more detectors. Both preflight and in-flight calibrators must cover a wider field, making collimators and radiometric calibrators more expensive. In fact, no other instrument with calibration as extensive as MODIS has been built and tested. Similar calibration complexity would be even more difficult, expensive, and risky for a WFOV system.

3. MODIS follow-on approach: Selection process

Selection of the appropriate MODIS follow-on option will require spacecraft interface accommodation studies and mission cost analysis, as well as further instrument design option cost and risk assessment. A simple com-

parison of the three MODIS Light options is, however, revealing. Key known parameters include mass, total volume, and spacecraft mounting area. Removal of the calibrators results in nearly a 40-kg mass reduction, but no reduction in volume or spacecraft footprint. Further repackaging, but retaining the baseline scan configuration, results in an additional 40-kg mass reduction and a substantial reduction in volume. Finally, scan redesign results in a minor further mass savings, but further volume reduction and a substantial reduction in spacecraft footprint. Final selection will be governed by spacecraft accommodation and available resources.

4. Summary

The MODIS protoflight model has been delivered for a June 1998 EOS AM-1 platform launch, and the second flight model is under way for completion in summer 1998. Convergence of the DMSP and the NOAA POES program to the NPOESS is spurring interest in MODIS capability. MODIS is expected to meet many of the 26 NPOESS visible-IR imager radiometer suite EDRs. Focal plane and data readout redesign would allow MODIS to meet the NPOESS imagery EDR HSR requirements. Concerns about MODIS cost, mass, and volume have resulted in assessment of smaller concepts. Substantial size and mass reduction can, in principle, be achieved using WFOV pushbroom AMODIS concepts, while MODIS Light options retain the MODIS OBA to minimize risk.

Acknowledgments. The authors acknowledge review by the MODIS project at NASA/Goddard Space Flight Center and Santa Barbara Remote Sensing (SBRS), and especially SBRS-funded MODIS Light analysis and design by a system engineering team led by T. Pagano of SBRS. The authors also acknowledge the comments and suggestions of the anonymous peer reviewers.

APPENDIX

Acronym Glossary

AMODIS	Advanced Moderate Resolution Imaging Spectroradiometer
AVHRR	Advanced Very High Resolution Radiometer
CrIMSS	Cross-Track Infrared/Microwave Sounder Suite
CrIS	Cross-Track Infrared Sounder (component of CrIMSS)
CTE	Coefficient of Thermal Expansion
CZCS	Coastal Zone Color Scanner
DOC	Department of Commerce
DOD	Department of Defense
DMSP	Defense Meteorological Satellite Program
EDR	Environmental Data Record
EOS	Earth Observing System

ETM+	(Landsat) Enhanced Thematic Mapper Plus
FPA	Focal Plane Assembly
GSFC	(NASA) Goddard Space Flight Center
HIRS	High-Resolution Infrared Sounder
IPO	Integrated Program Office (see NPOESS)
IR	Infrared
JPL	Jet Propulsion Laboratory
LWIR	Longwave Infrared
MODIS	Moderate Resolution Imaging Spectroradiometer
MODIS-L	Moderate Resolution Imaging Spectroradiometer Light
MTF	Modulation Transfer Function
MWIR	Midwave Infrared
NASA	National Aeronautics and Space Administration
NDVI	Normalized Difference Vegetation Index
NOAA	National Oceanic and Atmospheric Administration
NPOESS	National Polar-Orbiting Operational Environmental Satellite System
NRE	Nonrecurrent Engineering
OBA	Optical Bench Assembly
OLS	Operational Line-Scanning System
POES	Polar Operational Environmental Satellites
S/C	Spacecraft
S/W	Software
SBRS	Santa Barbara Remote Sensing
SDSM	Solar Diffuser Stability Monitor
SNR	Signal-to-Noise Ratio
SRCA	Spectroradiometric Calibration Assembly
SWIR	Shortwave Infrared
TRD	Technical Requirements Document
VIIRS	Visible-Infrared Imager Radiometer Suite
VNIR	Visible and Near Infrared
WFOV	Wide Field of View

REFERENCES

- Abbott, M. R., and D. B. Chelton, 1991: Advances in passive remote sensing of the ocean, U.S. National Report to IUGG. *Rev. Geophys.*, **29** (Suppl.), 571–583.
- Allison, L. J., and A. Schnapf, 1983: Meteorological satellites. *Manual of Remote Sensing*, D. Simonett and F. Ulaby, Eds., American Society of Photogrammetry and Remote Sensing, 651–659.
- Barnes, W. L., and V. V. Salomonson, 1993: MODIS: A global imaging spectroradiometer for the Earth Observing System. *Critical Reviews of Optical Science and Technology*, J. E. Pearson, Ed., SPIE, Vol. CR47, 285–307.
- Brown, O. B., cited 1996: MODIS Infrared Sea Surface Temperature, ATBD-MOD-26. [Available on-line from <http://eospsso.gsfc.nasa.gov/atbd/modis/atbdmod26.html>.]
- Carder, K. L., F. R. Chen, Z. P. Lee, S. Hawes, and D. Kamykowski, 1998: Semi-analytical MODIS algorithms for chlorophyll a and absorption with bio-optical domains based on nitrate-depletion temperatures. *J. Geophys. Res.*, in press.
- Dozier, J., and Z. Wan, 1994: Development of practical multiband algorithms for estimating land-surface temperature from EOS/MODIS data. *Adv. Space Res.*, **14**, 81–90.
- Hall, D. K., G. A. Riggs, and V. V. Salomonson, 1995: Development of methods for mapping global snow cover using Moderate Resolution Imaging Spectroradiometer (MODIS) data. *Remote Sens. Environ.*, **54**, 127–140.
- Huete, A. R., and H. Liu, 1994: An error and sensitivity analysis of the atmospheric- and soil-correcting variants of the NDVI for the MODIS-EOS. *IEEE Trans. Geosci. Remote Sens.*, **32** (4), 897–905.
- Kaufman, Y. J., and B.-C. Gao, 1992: Remote sensing of water vapor in the near IR from EOS/MODIS. *IEEE Trans. Geosci. Remote Sens.*, **30**, 871–884.
- Kidder, S. Q., and T. H. Vonder Haar, 1995: *Satellite Meteorology: An Introduction*. Academic Press, 466 pp.
- King, M. D., Y. J. Kaufman, W. P. Menzel, and D. Tanre, 1992: Remote sensing of cloud, aerosol, and water vapor properties from the Moderate Resolution Imaging Spectroradiometer (MODIS). *IEEE Trans. Geosci. Remote Sensing*, **30**, 2–27.
- , D. D. Herring, and D. J. Diner, 1995: The Earth Observing System (EOS): A space-based program for assessing mankind's impact on the global environment. *Opt. Photon. News*, **6**, 34–39.
- Kramer, J. K., 1994: *Observation of the Earth and its Environment*. 2d ed. Springer-Verlag, 251 pp.
- Lee, Z. P., K. L. Carder, J. Marra, R. G. Steward, and M. J. Perry, 1996: Estimating primary production at depth from remote sensing. *Appl. Opt.*, **35** (3), 463–474.
- Letelier, R. M., and M. R. Abbott, 1996: An analysis of chlorophyll fluorescence algorithms for the Moderate Resolution Imaging Spectroradiometer (MODIS). *Remote Sens. Environ.*, **58**, 215–223.
- Liu, H. Q., and A. R. Huete, 1995: A feedback based modification of the NDVI to minimize soil and atmospheric noise. *IEEE Trans. Geosci. Remote Sens.*, **33**, 457–465.
- Menzel, P., and L. E. Gumley, cited 1994: MODIS Atmospheric Profile Retrieval, ATBD-MOD-07. [Available on-line from <http://eospsso.gsfc.nasa.gov/atbd/modis/atbdmod07.html>.]
- NASA, cited 1996: MODIS Home Page. [Available on-line from <http://ftpwww.gsfc.nasa.gov/MODIS/MODIS.html>.]
- NPOESS Integrated Program Office, cited 1996: NPOESS Optimized Convergence Briefing to Industry. [Available on-line from <http://www.laafb.af.mil/SMC/PK/NPOESS/rfp.htm>.]
- Pagano, T., M. Ballard, A. L. De Forrest, R. M. Hudyma, R. L. Julian, and A. L. Tessmer, 1996: Development of the Moderate Resolution Imaging Spectroradiometer (MODIS) Protoflight Model. *Proc. Society of Photooptical Instrumentation Engineers (SPIE)*, Denver, CO, SPIE, 10–24.
- Running, S. W., and Coauthors, 1994: Terrestrial remote sensing science and algorithm planned for EOS/MODIS. *Int. J. Remote Sens.*, **15** (17), 3587–3620.
- Strahler, A., A. Moody, and E. Lambin, 1995: Land cover and land-cover change from MODIS. *Proc. 15th Int. Geosci. and Remote Sensing Symp.*, Florence, Italy, IEEE, 1535–1537.
- UCAR, 1991: *Product Development Plans for Operational Satellite Products*. UCAR, 78 pp.
- Vermote, E., 1996: Atmospheric Correction Algorithm, Spectral Reflectance/Surface Leaving Radiance. ATBD-MOD-08. [Available on-line from <http://eospsso.gsfc.nasa.gov/atbd/modis/atbdmod08.html>.]
- Wanner, W., A. Strahler, J.-P. Muller, M. Barnsley, P. Lewis, X. Li, and C. B. Schaaf, 1995: Global mapping of bidirectional reflectance and albedo for the EOS MODIS project: The algorithm and the product. *Proc. 15th Int. Geosci. and Remote Sensing Symp.*, Florence, Italy, IEEE, 525–529.