

Modelling of service reservoirs

Hoi Yeung

ABSTRACT

Service reservoirs were built to provide the dual function of balancing supply with demand and provision of adequate head to maintain pressure throughout the distribution network. Changing demographics in the UK and reducing leakage have led to significant increases in water age and hence increased risk of poor water quality.

Computational fluid mechanics has been used to study the behaviour of a range of service reservoirs with a rectangular plan form. Detailed analysis of flow distribution and water age suggests that tanks with horizontal inlets are better mixed when compared with vertical top water level inlets. With increasing length to width ratio, the flow characteristics of tanks with vertical inlets increasingly resemble plug flow.

A new multi-channel reactor model was developed to model the recirculations in service reservoirs. This simple model can be used to characterise the flow characteristics of service reservoirs from tracer test results.

Key words | service reservoir, water quality, water age, computational fluid dynamics, reactor model

Hoi Yeung

Department of Process and Systems Engineering,
Cranfield University,
Cranfield, Beds
MK43 0AL, UK
Tel: +44 1234 750111
Fax: +44 1234 751875
E-mail: h.yeung@cranfield.ac.uk

INTRODUCTION

Historically, service reservoirs were built to provide the dual function of balancing supply with demand and provision of adequate head to maintain pressure throughout the distribution network. They provide a buffer between treatment and customer. They act as a safety net in the instance of a pollution incident at the source, treatment breakdown or failure, or an increase in peak demand. In many instances, service reservoirs act as a pressure release valve on the mains network, which helps to reduce bursts and leakage.

Changing demographics have left a number of water companies with the problem of having large storage vessels in areas where the demand has reduced significantly. In many parts of the UK there has been large scale closure of traditional industries. Water costs have led to modern industries looking for minimisation of water usage and increased water re-use. This, in addition to major reductions in leakage, has led to significant increases in water age. This is contributing to poor water quality, increased operational costs such as cost of primary

treatment, secondary chlorination, maintenance and additional manpower.

Recent investment in infrastructure has improved many companies' ability to transport supplies around their regions. With this increased operational flexibility it should be feasible to reduce storage where additional sources are readily available. However, there is a reluctance to replace or bypass assets, even when they impose some risk to water quality.

As service reservoirs were designed with a focus of maintaining supply and pressure, there was only a limited understanding that detrimental flow patterns could be induced during operation. As a consequence, these assets can be hydraulically very inefficient, with large areas of tank containing very slow moving or stagnant water. Changes in operation which affect the ratio of inflows, outflows and operating levels can significantly change the flow profile through the tank. When this occurs, water of unknown and possibly very poor age and quality (e.g. bacteriological integrity, disinfection by-products,

chlorine levels, conductivity, redox potential, water stability and dissolved oxygen levels) can pass into the distribution system. The potential impact of these variations of water quality is clearly very complex; some of this is masked by the practice of secondary chlorination (i.e. the injection of chlorine at the exit of the service reservoir).

Understanding the hydraulic behaviour of reservoirs means that control of pollution incidents may be more easily achieved. If the actual residence time in the network was known, a pollution incident could be mapped through the distribution system to provide advance warning to some customers in the event of notices to boil water.

This paper describes some of the results of a research programme aimed at understanding the hydraulics inside service reservoirs. Computational Flow Dynamics (CFD) simulations were carried out for a range of common tanks. The effects of different inlet arrangements were studied. The use of CFD removes subjectivities of physical model tests. A new reactor model was developed to model the recirculating flows commonly found in service reservoirs. This simple model can be used to characterise the behaviour of any tank from tracer tests.

PHYSICAL MODELLING OF SERVICE RESERVOIR

Water companies and consultants have traditionally relied on the use of scaled physical models to study the hydraulic behaviour of processes such as sedimentation tanks and chlorine contact tanks. O'Donoghue *et al.* (1994) reported the use of multiple jets to provide rapid mixing in his model. The performance was determined by analysing photographic records of the movement of dye and tracer particles on the water surface. They concluded that a side entry horizontal inlet resulted in a better-mixed tank when compared with downward facing top entry inlets. Jones (1992) used a 1:7 scaled model to study the effects of different type of inlets. It was concluded that the use of two high level inlets located at the corners across the tank width would contribute most towards maintaining a stable well mixed flow regime. Grayman *et al.* (1998) conducted a

series of mixing time experiments on model scale service reservoir of 1.2 m × 1.2 m × 0.1 m equipped with different inlet arrangements. Again, video images taken from above the tank were used to determine mixing time. These types of analysis cannot be reliable as dye moving near the surface hides the true picture underneath.

CFD MODELLING

The advantage of CFD is that, once the calculation is completed, information is available for every cell within the tank. The use of CFD by the water industry to analyse flow behaviour is increasing, e.g. a service reservoir by Ta & Brignal (1998), a secondary treatment plant by Robinson & Stainsby (1996), a chlorine contact tank by Hannoun & Boulos (1997) and an ozone contact tank by Lo & Murrer (1995).

The commercial software CFX version 4.1 was used in the study described in this paper. The boundary conditions applied for all the simulations were: (i) free slip conditions at the top water surface with no slip conditions at the retaining walls, (ii) a logarithmic wall boundary layer profile, and (iii) specification of the inlet and the outlet boundaries. The $k-\varepsilon$ turbulence model was used in preference to higher order turbulence models.

WATER AGE

Water companies are interested in the age of water in service reservoirs because the active disinfectant that is added at the water treatment works will decrease with time. Regions of very old water within a service reservoir will have relatively low levels of disinfectant; hence, at these locations there is the potential for the accumulation of harmful micro-organisms.

In order to obtain the average age distribution it was first necessary to obtain a steady state flow field. Once the steady state solution had been found, the required velocity components, \bar{u}_i , were extracted to solve the time averaged scalar advection diffusion transport equation as given by

Equation (1). The superscript ' represents the fluctuating component of a variable:

$$\frac{\partial}{\partial x_i} \left[\overline{\rho u_i \phi} + \overline{\rho u_i' \phi'} - \Gamma \frac{\partial \overline{\phi}}{\partial x_i} \right] = \overline{S}. \quad (1)$$

The scalar, $\overline{\phi}$, represents the average time taken for a particle of water to travel from the inlet to a particular point within the computational domain. The fluid age is regarded as being transferred by convection and by the turbulent diffusive flux terms. Hence the scalar diffusion coefficient, Γ , is set to zero. To satisfy the condition that $d\overline{\phi}/dt = 1$ (Lo & Murrer 1995), the source term \overline{S} of Equation (1) is equal to the fluid density, ρ :

$$\frac{\partial}{\partial x_i} [\overline{\rho u_i \phi} + \overline{\rho u_i' \phi'}] = \rho. \quad (2)$$

RESIDENCE TIME DISTRIBUTION

The experimental method of obtaining a residence time distribution is by monitoring the concentration at the outlet after a pulse of tracer has been injected at the inlet. Tracer curves can also be obtained from CFD simulations. Starting with a transient formulation of Equation (1) in which $\overline{\phi}$ represents the averaged scalar concentration, the source term \overline{S} is set to zero and the diffusion coefficient is taken as being approximately equal to that of the tracer in water ($\Gamma = 1.0 \times 10^{-6}$ kg/m s for common salt). The maximum allowable time step for a CFD concentration time tracer test is determined by the Courant–Friedrichs–Lewy condition (Hirsch 1994). This relates the speed of information propagation in the scalar transport equation to the speed of information propagation in the mesh.

PERFORMANCE OF GENERIC SERVICE RESERVOIR DESIGN

Right at the outset of the research programme, it was decided that it would be prohibitively expensive to simulate all the different designs. A survey was carried out

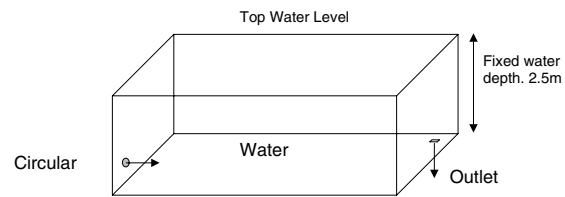

Figure 1a Circular side wall horizontal inlet.

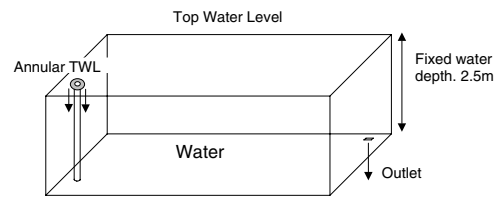

Figure 1b. Annular free surface (TWL) inlet.

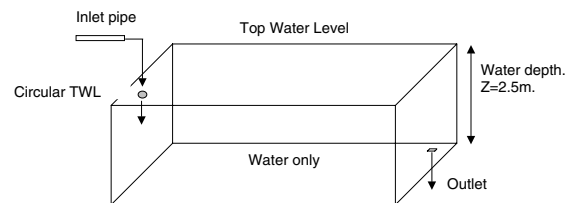

Figure 1 | (a) Circular side wall horizontal inlet. (b) Annular free surface (TWL) inlet. (c) Circular free surface (TWL) inlet.

to determine the most common geometry. It was found that a rectangular shape was by far the most common. Three aspect ratios, length to width ratios were modelled, $L:W = 1.1, 1.5$ and 2 . The most common inlet arrangements were horizontal, upturned bell mouth and top entry (via float valve) (see Figures 1(a–c)). The upturned bell mouth was simulated by means of an annular downward pointing annular ring in the CFD model.

RESIDENCE TIME DISTRIBUTION (TRACER TESTS)

Figure 2 shows the tracer concentration at the outlet of the reservoir plotted against normalised time, $\theta = t/T$, with $L:W = 1.1$.

As shown on the graph for the side wall circular inlet, the sinusoidal profile of the curve indicates that there is a

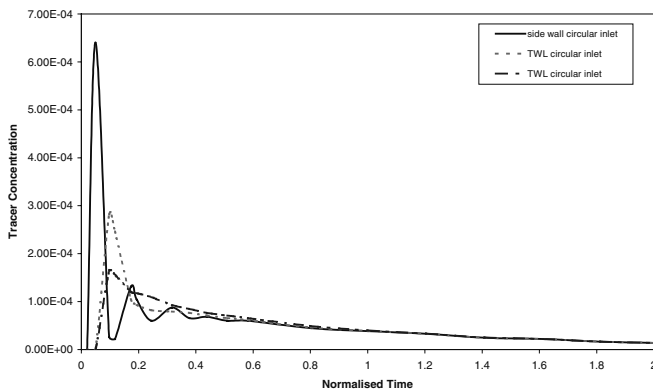

Figure 2 | Tracer curves for service reservoirs of length to width ratio 1.1.

significant amount of flow recirculation in the tank. Following an initial time delay of $\theta(0) = 1.3 \times 10^{-2}$ where the first appearance of tracer is recorded at the outlet (outlet scalar value reaches $1.0 \times 10^{-10} \text{ kg/m}^3$), the curve rises sharply to a peak value of $6.5 \times 10^{-4} \text{ kg/m}^3$ and then drops to a relatively low value of $0.3 \times 10^{-4} \text{ kg/m}^3$. This peak to trough to peak profile is repeated with an average circulation time of $\theta_{\text{Circ}} = 0.13$.

The successive dropping and spreading out of the peaks indicates that the tracer is being entrained by the main recirculating flow, and is increasingly dispersed throughout the bulk volume of the tank. After the final peak, the curve follows an exponential (mixed) profile, indicating that the tracer has reached a more or less uniform distribution throughout the tank.

The tracer curve for the top water level annular inlet indicates that no clear recirculation of the flow takes place. Following an initial time delay, $\theta(0)$ of 3.2×10^{-2} , the tracer rises steadily to a peak value of $2.8 \times 10^{-4} \text{ kg/m}^3$. The tracer then drops to a value of about $1.0 \times 10^{-4} \text{ kg/m}^3$ at time $\theta = 0.18$. Following this point the tracer decays into an exponential profile.

The tracer curve for the top water level circular inlet also indicates that no recirculation of the main flow takes place. However, a second slight peak that occurs at time $\theta = 0.2$ indicates that a small amount of flow circulation may be present. Alternatively, this second peak may result from the initial input of tracer being effectively divided into two as it hits the bottom of the tank. The resulting

time delay between the two fractions would then lead to a second peak at the outlet stream.

For this tracer curve the time taken for the initial appearance of the trace at the outlet is 2.6×10^{-2} , beyond this point the tracer rises more slowly than for the TWL annular inlet and has a smaller maximum value of $1.7 \times 10^{-4} \text{ kg/m}^3$.

Table 1 summarises the above information for all aspect ratios.

WATER AGE

Figure 3 shows the water age distribution inside a tank with side wall inlet. The water at the centre of the bulk recirculation and at the top right corner is older than the other regions.

Figure 4 shows the fractional tank volume plotted against water age for three different inlet types. For a perfectly mixed tank, 100% of the volume will contain water with an average water age the same as the nominal retention time, T . For a plug flow tank, the age distribution is in the form of a straight line.

Figure 4(a-c) show that tanks with side wall circular inlets behave more like a mixed tank. The percentage of the tank volume occupied by water age between 0.9–1.1 is highest for the side wall inlet. With increasing $L:W$, the two top water level inlet tanks behave more and more like a plug flow tank. The age distribution for side wall inlet does not vary significantly with increasing $L:W$, suggesting that it is a more robust design.

A MULTICHANNEL REACTOR MODEL

Reactor models are conceptual models to represent the flow behaviours within the process vessels or reactors. Plug and mixed are the two ideal reactors. Chemical engineers often use a combination of these two ideal reactors to simulate real reactor flows; see Levenspiel (1972).

Kennedy *et al.* (1993) fitted a perfectly mixed reactor model to the output response curves obtained from three

Table 1 | Summary of data for service reservoirs of length to width ratio 1.1

Inlet type	L:W	Description of flow	$\theta(0)$	θ_{circ}
Circular, side wall	1.1	Strong recirculation	1.3×10^{-2}	0.13
Circular, side wall	1.5	Strong recirculation	1.2×10^{-2}	0.12
Circular, side wall	2	Strong recirculation	1.1×10^{-2}	0.11
Annular, TWL	1.1	Dispersed plug	3.2×10^{-2}	—
Annular, TWL	1.5	Weak circulation	3.8×10^{-2}	0.30
Annular, TWL	2	Moderate circulation	4.2×10^{-2}	0.3
Circular, TWL	1.1	Dispersed plug	2.6×10^{-2}	—
Circular, TWL	1.5	Dispersed plug	3.2×10^{-2}	—
Circular, TWL	2	Dispersed plug	3.6×10^{-2}	—

cylindrically shaped service reservoirs with aspect ratios of 0.4:1, 1.4:1 and 3.5:1. It was found that varying degrees of goodness of fit could be achieved. It was also suggested that a better approximation might be obtained by the incorporation of parameters that could be used to represent both stagnant volume and short-circuiting within the tanks.

Based on site trials, Boulos *et al.* (1995) have confirmed that, for most practical applications, the assumption of perfect mixing within a service reservoir does not

provide an adequate description of the real flows that take place. Mau *et al.* (1996) discussed the application of a linear compartment model that consisted of a series of conceptual elements that included: (i) a boundary volume zone between the inlet and the outlet, (ii) a zone of fixed stagnant volume, and (iii) a region of variable mixed volume. The introduction of these additional terms did improve the closeness of fit of the reactor model to test data. The reactor model, however, makes no reference to the possibility of allowing flow recirculation to take place: hence this type of model is likely to be limited in its application to service reservoirs.

To be able to model the recirculation, a new reactor model has been developed. The layout of this recirculating model is given in Figure 5. The model is composed of a number of 'channels' of plug and mixed flow reactors (CSTR). At time $t = 0$ s, an amount of tracer (ϕt) is injected at the inlet stream. The tracer then passes through a plug flow vessel, thereby providing the required time delay for the fraction of tracer (ϕt_1) that enters channel 1. The remainder of the tracer then passes through a second plug flow vessel which provides the time delay for fraction (ϕt_2) that enters channel 2. The tracer continues to move downwards through a series of plug flow vessels. At the exit from each tank a fraction of the tracer (ϕt_i) passes

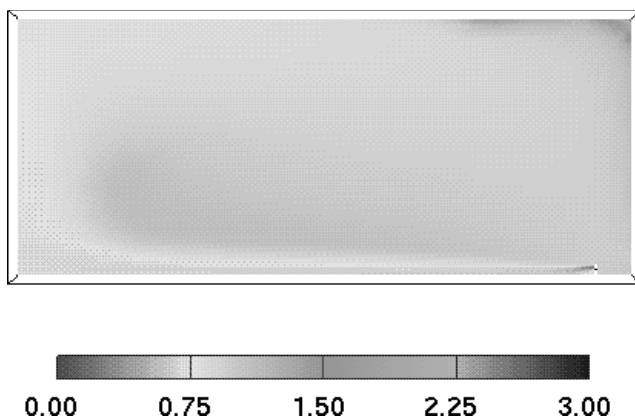
**Figure 3** | Water age distribution inside a tank.

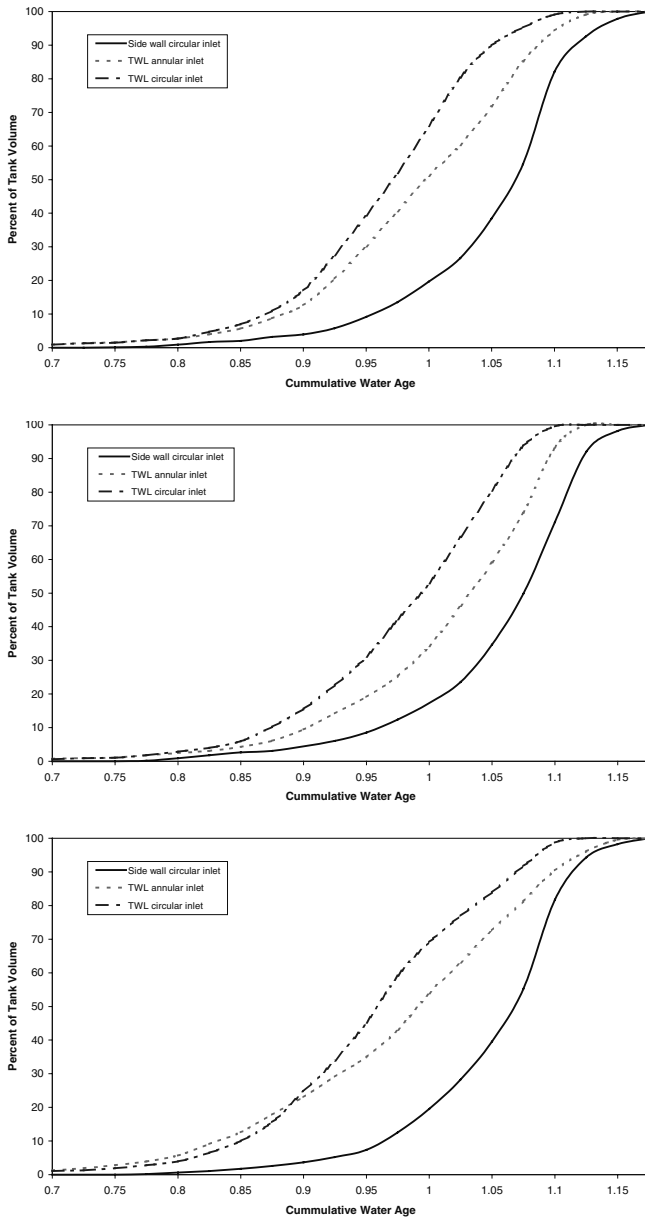

Figure 4 | Plot of tank volume against cumulative water age. (a) $L:W=1.1$, (b) $L:W=1.5$, (c) $L:W=2$.

along channel i . At the last plug flow vessel the remaining fraction of the tracer (ϕt_N) is allowed to pass along channel N .

At the exit from each plug flow vessel the fractional amount of tracer (ϕt_i) is passed through a series of n mixed reactors. The parameters of n and T are tuned as required to obtain the best fit with experimental data.

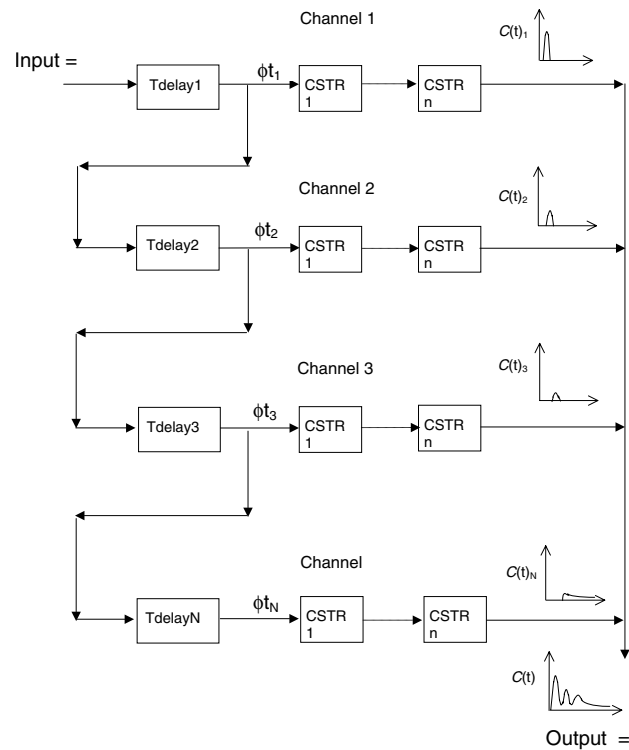

Figure 5 | Schematic diagram of the N channel reactor model.

The above N channel reactor model can be described mathematically by making use of the Heaviside unit step function as defined by James (1994) as $H(t - \text{time delay})$. The usefulness of this function lies in its ability to model the initial time delay of the flow as it passes through each of the plug flow vessels located at channels 1 to N . The sum of the outputs from each series is given by Equation (3):

$$\begin{aligned}
 C(t) = & H(t - T_{\text{delay}1}) \frac{C(0)_1}{(n-1)!} \\
 & \left(\frac{n(t - T_{\text{delay}1})}{T_{\text{CSTR}(1-n)}} \right)^{n-1} e^{-\frac{n(t - T_{\text{delay}1})}{T_{\text{CSTR}(1-n)}}} \\
 & + H(t - T_{\text{delay}2}) \frac{C(0)_2}{(n-1)!} \left(\frac{n(t - T_{\text{delay}2})}{T_{\text{CSTR}(1-n)}} \right)^{n-1} e^{-\frac{n(t - T_{\text{delay}2})}{T_{\text{CSTR}(1-n)}}} \\
 & + H(t - T_{\text{delay}3}) \frac{C(0)_3}{(n-1)!} \left(\frac{n(t - T_{\text{delay}3})}{T_{\text{CSTR}(1-n)}} \right)^{n-1} e^{-\frac{n(t - T_{\text{delay}3})}{T_{\text{CSTR}(1-n)}}} \\
 & + H(t - T_{\text{delay}N}) \frac{C(0)_N}{(n-1)!} \left(\frac{n(t - T_{\text{delay}N})}{T_{\text{CSTR}(1-n)}} \right)^{n-1} e^{-\frac{n(t - T_{\text{delay}N})}{T_{\text{CSTR}(1-n)}}}
 \end{aligned} \tag{3}$$

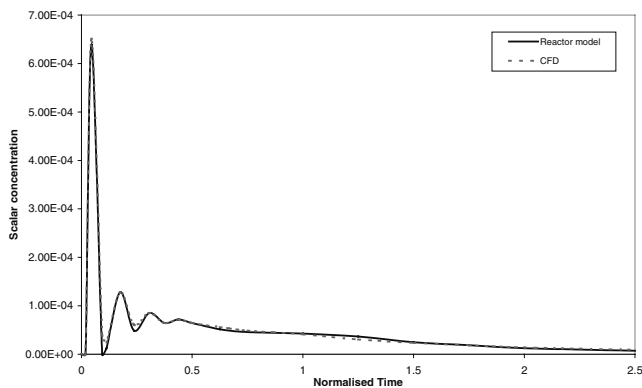

Figure 6 | Fitted reactor curve for a service reservoir with a side wall circular inlet ($L:W=1.1$).

Figure 6 shows the result of the reactor models for $L:W=1.1$ plotted together with the CFD simulated tracer curve. The model parameters are given in Table 2.

It can be seen that the model gives a reasonable representation of the flow behaviour in the tank. The number of mixed reactors, n , decreases with channel number. This implies the flow characteristics change from plug to 'more mixed' as it moves round the tank. Also the size of the mixed reactor increases, reflecting the entrainment of surrounding fluid with each circulation. The

circulation time can be deduced from the difference of the delay time for each successive pass (channel).

The model is useful for the interpretation of flow characteristics within the tank from tracer tests. Once the model is established, it can be used for feed forward control of chlorine residual at the outlet of the reservoir.

CONCLUSION

The performance of rectangular service reservoir of aspect ratios of 1.1, 1.5 and 2 has been characterised by the use of CFD. CFD can be used not only to give the flow field but also the water age within the tank. It has many advantages over physical modelling by removing the subjectivities in the interpretation of results. Water age calculations confirmed that tanks with side wall inlets are better mixed than tanks with top water level inlets. With the increase of $L:W$ ratio, tanks with top water level inlets become more and more like plug flow tanks.

A multi-channel reactor model has been developed. This model can represent recirculations in service reservoirs with reasonable accuracy. Such models can be used to characterise the flow behaviour of a service reservoir

Table 2 | Reactor model parameter for a service reservoir with a side wall circular inlet ($L:W=1.1$)

Parameter	Channel 1	Channel 2	Channel 3	Channel 4	Channel 5
$C(0)$	4.85×10^{-3}	7.50×10^{-4}	3.71×10^{-4}	1.40×10^{-4}	1.19×10^{-4}
T_{delay}	1.4×10^{-2}	8.92×10^{-2}	2.20×10^{-1}	3.40×10^{-1}	3.71×10^{-1}
θ_{Circ}	—	0.13	—	—	—
n	10	6	4	3	2
T (s)	3,000	8,500	10,900	16,000	85,000
Q (m^3/s)	3.18×10^{-3}	3.18×10^{-3}	3.18×10^{-3}	3.18×10^{-3}	3.18×10^{-3}
V (m^3)	9.54	27.03	34.66	44.52	270.30
ϕt	1.455	1.063	1.011	0.747	5.058

CFD input=10.0, sum of $\phi t=9.334$, tracer lost=10.0-9.334=0.667.

from simple tracer tests. The model can be used for feed forward control of chlorine residuals at the outlet of the reservoir.

The work presented in this paper is limited to steady flows. As mentioned in the introduction, flows in service reservoirs are never steady. Further work is required to study the flow characteristics of push–pull tanks and tanks with variable water levels, variable inlet and outlet flow.

NOMENCLATURE

C	concentration
S	source term
t	time
T	nominal retention time
\bar{u}_i	average velocity component
u_i	fluctuating velocity component
Γ	diffusion coefficient
φ	scaler quantity
ρ	density
θ	normalised time (t/T)

REFERENCES

- Boulos, P. F. *et al.* 1996 Hydraulic mixing and free chlorine residual in reservoirs. *J. AWWA* **88**(7), 48–59.
- Grayman, W. M., Rossman, L. A., Arnold, C. & Deininger, R. 1998 *Water Quality Modelling of Distribution System Storage Facilities*. AWWA Research Foundation and American Water Works Association, Draft Report 1998.
- Hannoun, I. A. & Boulos, P. F. 1997 Optimising distribution storage water quality: a hydrodynamic approach. *Appl. Math. Model.* **21**(8), 495–502.
- Hirsch, C. 1994 *Numerical Computation of Internal and External Flows*, vol. 1. *Fundamentals of Numerical Discretization*. John Wiley & Sons, Chichester.
- James, G. 1994 *Advanced Modern Engineering Mathematics*. Addison Wesley, New York.
- Jones, M. 1992 *Improvements to Service Reservoir Model Testing*. Hydraulic Models Ltd, Leeds.
- Kennedy, M. S., Moegling, S., Sarikelle, S. & Suravallop, K. 1993 Assessing the effects of storage tank design on water quality. *J. AWWA* **85**(7), 78–88.
- Levenspiel, O. 1972 *Chemical Reaction Engineering*, 2nd edn. John Wiley & Sons, Chichester.
- Lo, S. & Murrer, J. 1995 A CFD model of an ozone contact tank. *3rd International Conference in Water and Waste Water Treatment, 13–15 November 1995, Harrogate, UK*. BHR Group Conference Series, Publication No. 17, pp. 265–277.
- Mau, R. *et al.* 1995 Explicit mathematical models of distribution storage water quality. *J. Hydraul. Engng* **10**, 699–709.
- O'Donoghue, T., Littlejohn, J. & Shaun, R. 1994 Hydraulic model study to investigate mechanisms for improved mixing in service reservoirs. *Proc. 2nd International Conference on Hydraulic Modelling*. BHR Group Conference Series Publications No 11, pp. 79–91.
- Robinson, C. M. E. & Stainsby, R. 1996 CFD predictions of residence times in wastewater secondary treatment processes by transient dye trace simulations and steady state fluid age solutions. *Third CFX International Users Conference, Oct/Nov 1996*. AEA Technology, Harwell.
- Ta, C. T. & Brignal, W. J. 1998 Application of computational fluid dynamics technique to storage reservoir studies. *Wat. Sci. Technol.* **37**(3), 219–226.