

# Comparison of Static End-expiratory and Effective Lung Volumes for Gas Exchange in Healthy and Surfactant-depleted Lungs

Gergely Albu, M.D., Ph.D.,\* Mats Wallin, M.D., Ph.D.,† Magnus Hallbäck, M.Sc., Ph.D.,‡ Per Emtell, B.Sc.,§ Andrew Wolf, M.D.,# Per-Arne Lönnqvist, M.D., Ph.D.,\*\* Sylvia Göthberg, M.D., Ph.D.,|| Ferenc Peták, Ph.D.,†† Walid Habre, M.D., Ph.D.‡‡

## ABSTRACT

**Background:** Effective lung volume (ELV) for gas exchange is a new measure that could be used as a real-time guide during controlled mechanical ventilation. The authors established the relationships of ELV to static end-expiratory lung volume (EELV) with varying levels of positive end-expiratory pressure (PEEP) in healthy and surfactant-depleted rabbit lungs. **Methods:** Nine rabbits were anesthetized and ventilated with a modified volume-controlled mode where periods of five consecutive alterations in inspiratory/expiratory ratio (1:2–1.5:1) were imposed to measure ELV from the corresponding carbon dioxide elimination traces. EELV and the lung clearance

\* Research Fellow, Pathophysiological Experimental Platform, Department of Anesthesiology, Pharmacology and Intensive Care, University of Geneva, Geneva, Switzerland. † Academic Supervisor, Karolinska Institute, Solna, Sweden, and Maquet Critical Care AB. ‡ Senior Scientist, § Research Engineer, || Medical Director, Maquet Critical Care AB, Solna, Sweden. # Professor, Consultant in Paediatric Anaesthesia and Intensive Care, Bristol Royal Hospital for Children, Bristol, United Kingdom. \*\* Professor, Senior Consultant, Paediatric Anaesthesia and Intensive Care, Astrid Lindgrens Children's Hospital, Karolinska University Hospital, Stockholm, Sweden. †† Associate Professor, Department of Medical Physics and Informatics, University of Szeged, Szeged, Hungary. ‡‡ Associate Professor, Pediatric Anesthesia Unit and Pathophysiological Experimental Platform, Department of Anesthesiology, Pharmacology and Intensive Care, University Hospital of Geneva, Geneva, Switzerland.

Received from the Pediatric Anesthesia Unit, Department of Anesthesiology, Pharmacology and Intensive Care, University Hospital of Geneva, Geneva, Switzerland. Submitted for publication May 22, 2012. Accepted for publication March 4, 2013. This study was funded by a research grant from Maquet Critical Care AB (Solna, Sweden). Dr. Peták is supported by a Bolyai János Research Fellowship (Budapest, Hungary). Dr. Wallin, Dr. Hallbäck, Mr. Emtell, and Dr. Göthberg work at the Research Department of the Maquet, Critical Care AB (Solna, Sweden), and they established the theoretical bases of the measurement technique tested in the current article. Drs. Wolf, Lönnqvist, and Habre received a research grant from Maquet for acting as consultant in the respiratory developments. The laboratory where the experiments were performed received a fund from Maquet to partially cover the material costs.

Address correspondence to Dr. Habre: Pediatric Anesthesia Unit, Geneva Children's Hospital, University Hospital of Geneva, 6, Rue Willy Donzé, 1205 Geneva, Switzerland. walid.habre@hcuge.ch. Information on purchasing reprints may be found at [www.anesthesiology.org](http://www.anesthesiology.org) or on the masthead page at the beginning of this issue. ANESTHESIOLOGY's articles are made freely accessible to all readers, for personal use only, 6 months from the cover date of the issue.

Copyright © 2013, the American Society of Anesthesiologists, Inc. Lippincott Williams & Wilkins. Anesthesiology 2013; 119:101-10

## What We Already Know about This Topic

- Measurements of end-expiratory lung volume (EELV) require plethysmography or wash-in/wash-out of an inert gas

## What This Article Tells Us That Is New

- The effective lung volume participating in gas exchange was estimated at the bedside by the differential Fick method and shown to be highly correlated with the end-expiratory lung volume, suggesting its use clinically

index were concomitantly determined by helium wash-out technique. Airway and tissue mechanics were assessed by using low-frequency forced oscillations. Measurements were collected at PEEP 0, 3, 6, and 9 cm H<sub>2</sub>O levels under control condition and after surfactant depletion by whole-lung lavage. **Results:** ELV was greater than EELV at all PEEP levels before lavage, whereas there was no evidence for a difference in the lung volume indices after surfactant depletion at PEEP 6 or 9 cm H<sub>2</sub>O. Increasing PEEP level caused significant parallel increases in both ELV and EELV levels, decreases in ventilation heterogeneity, and improvement in airway and tissue mechanics under control condition and after surfactant depletion. ELV and EELV exhibited strong and statistically significant correlations before ( $r = 0.84$ ) and after lavage ( $r = 0.87$ ). **Conclusions:** The parallel changes in ELV and EELV with PEEP in healthy and surfactant-depleted lungs support the clinical value of ELV measurement as a bedside tool to estimate dynamic changes in EELV in children and infants.

**D**ESPITE the progress in pediatric anesthesia management, respiratory adverse events remain one of the major causes of morbidity and mortality during anesthesia.<sup>1-3</sup> Hypoxemia is often encountered during mechanical ventilation of children, as a consequence of the altered physiological characteristics of infant and pediatric lungs: relatively increased chest compliance compared with adults,<sup>4</sup> decreased lung recoil and increased airway resistance. In addition to these factors, general anesthesia may further precipitate gas exchange impairment by promoting airway closure and development of atelectasis. All these mechanisms promote airway closure and may lead to lung volume loss, development of atelectasis, and suboptimal gas exchange.<sup>4,5</sup> Moreover, there are numerous pathophysiological conditions in pediatric clinical practice, which may lead

to a decrease in the lung volume available for gas exchange, including sepsis, cardiopulmonary bypass, blood transfusion, and endotracheal suction.

Ventilation strategies that are used to optimize lung volumes participating in gas exchange are based on the application of recruitment maneuvers followed by adjustment of a positive end-expiratory pressure (PEEP) to restore functional residual capacity as reflected in the measurement of end-expiratory lung volume (EELV).<sup>4</sup> Bedside monitoring of the lung volume participating in the gas exchange (the effective lung volume [ELV]) would be of great value in guiding clinicians to apply the optimal ventilation strategy. Nevertheless, the available current techniques that assess EELV, such as plethysmography or foreign gas wash-in/wash-out tests, cannot be readily applied as routine bedside monitoring. In addition, the EELV provides more information about the anatomical aspects rather than giving insight into the physiologically available lung volume for gas exchange.

In an attempt to estimate the lung volume effectively participating in the gas exchange during mechanical ventilation, recent interest has emerged toward breath-by-breath analysis of carbon dioxide after alteration of the inspiratory pattern (based on the differential Fick method).<sup>6</sup> To date, the relationship of ELV to the conventional static lung volume parameters (such as EELV obtained by wash-out tests) has not been evaluated.

A combined analysis of lung volume and respiratory mechanical parameters has been shown to identify and quantify adverse lung functional changes and can be used to guide ventilation strategy in the presence of acute lung injury (ALI).<sup>7</sup> We therefore set out to characterize the value of ELV to follow lung volume alterations with PEEP, and to relate these changes to those obtained with the well-validated helium wash-in/wash-out technique and respiratory mechanical indices obtained by forced oscillations. This was done in rabbits (whose lung volumes are similar to that of human neonates) with both normal lungs and after inducing acute lung injury by surfactant depletion.

## Materials and Methods

### Animal Preparation

After approval by the institutional ethics committee for experimental research of the University of Geneva (registration number 09-46) and animal welfare committee (Office Vétérinaire Cantonal de Genève registration number 1051/3502/2, Geneva, Switzerland), studies were performed on nine adult New Zealand white rabbits (weighing 2–2.5 kg). In all animals, anesthesia was induced by an intramuscular injection of xylazine (5 mg/kg), followed by an IV injection of midazolam (1 mg/kg) and pentobarbital sodium (30 mg/kg) *via* an ear vein. The rabbits were then tracheotomized, and mechanically ventilated with volume-controlled mode (7–8 ml/kg) by a commercial neonatal ventilator with additional software, Servo-i (Maquet Critical Care, Solna Sweden), with a frequency of 40 per min in order to obtain an end-tidal

carbon dioxide ( $ET_{CO_2}$ ) of 5.5–6%. The inspired oxygen fraction ( $F_{IO_2}$ ) was set to 0.5. A continuous IV infusion of midazolam (1 mg·kg<sup>-1</sup>·h<sup>-1</sup>) and fentanyl (100 µg·kg<sup>-1</sup>·h<sup>-1</sup>) was administered *via* the ear vein for maintenance of anesthesia. After ensuring adequate anesthesia and analgesia level, muscle relaxant (atracurium besylate, 0.5–1.0 mg·kg<sup>-1</sup>·h<sup>-1</sup>) was administered intravenously. The carotid artery and the jugular vein were cannulated for blood sampling, continuous arterial blood pressure monitoring, and for drug delivery. Rectal temperature was monitored with a temperature sensor (Thermalert, model TH-8; Physitemp, Clifton, NJ) and was maintained at 39.3° ± 0.5°C with a heating pad (Miostar, Zürich, Switzerland). Airway and arterial pressures, heart rate and rectal temperature were displayed and stored on a computer at a sampling rate of 50 Hz *via* an analog/digital interface converter (Biopac, Santa Barbara, CA).

### Measurement of EELV by Helium Wash-out Technique

The multiple-breath wash-in/wash-out technique, with helium as tracer gas, was used to measure EELV.<sup>8,9</sup> After inserting an ultrasonic flowmeter (Spiroson Scientific; ECO Medics AG, Dürnten, Switzerland) between the endotracheal tube connector and the ventilator circuit, helium was washed-in to the ventilatory circuit during several breaths until it reached a steady-state end-inspiratory concentration of 4–5%. The multiple breaths wash-out curve was subsequently recorded after interrupting the administration of helium; this wash-out phase was used to calculate EELV by using a computer algorithm (Spiroware V1.4.3; ECO Medics AG, Dürnten, Switzerland) provided by the ultrasonic flowmeter as follows:

$$EELV \text{ (ml)} = \frac{\text{Net volume of inert gas exhaled}}{C_{\text{start}} - C_{\text{end}}}$$

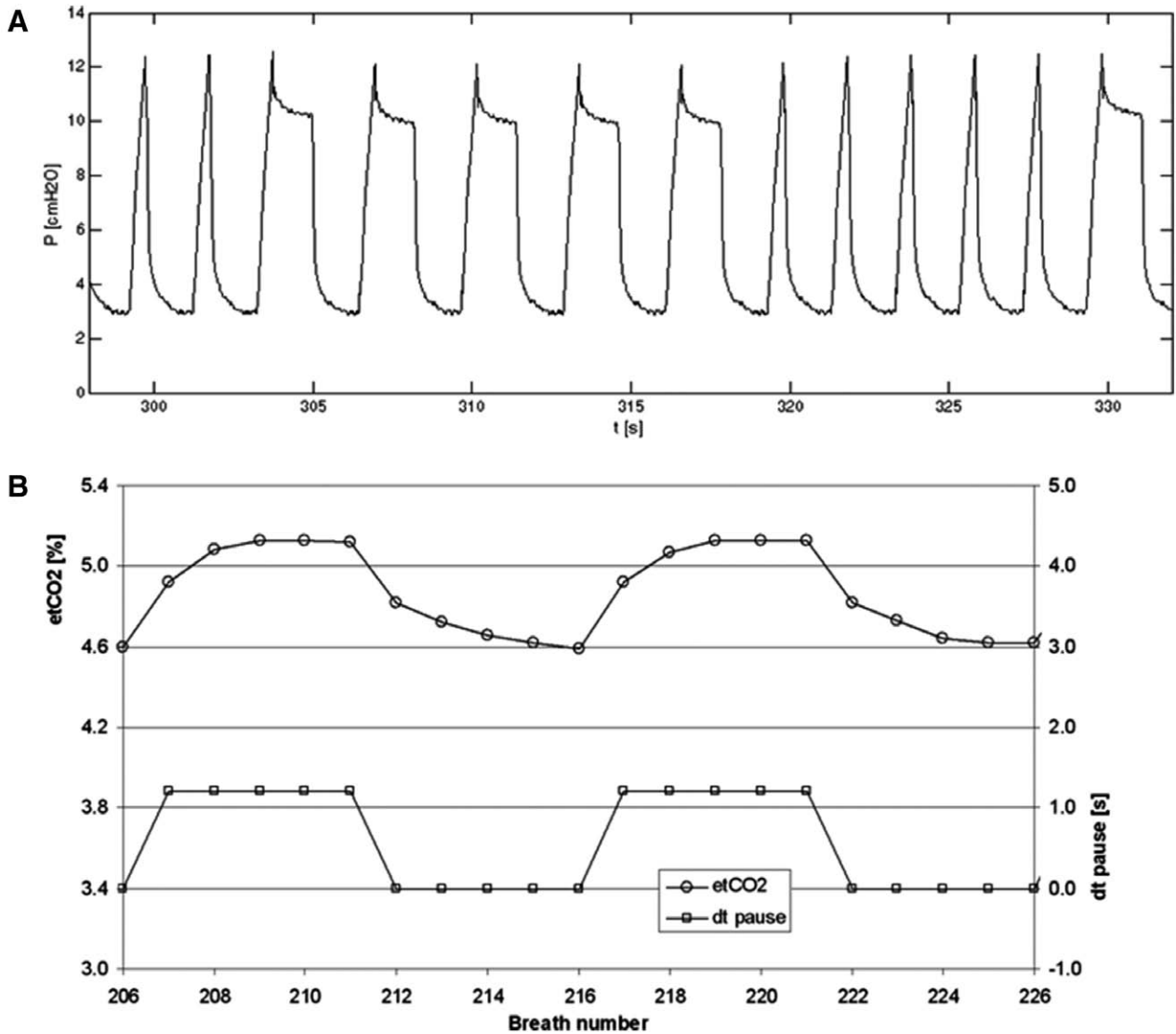
where  $C_{\text{start}}$  is the concentration at end-tidal volume of helium at the start and  $C_{\text{end}}$  at the end of the multiple-breath wash-in/wash-out recording. The dead space of the equipment (3.8 ml) was removed from the reported EELV values.

The EELV measurements were done twice for each animal with the special breathing pattern required for the ELV measurements.

Lung clearance index (LCI) was calculated as the number of lung volume turnovers required to clear the lungs of the inert marker gas to 1/40th of the starting concentration.<sup>10</sup>

### Measurement of ELV by Differential Fick Method

ELV, the lung volume taking part in gas exchange, was calculated using the differential Fick method (carbon dioxide). The additional software in the ventilator creates periods of five consecutive alterations in inspiratory/expiratory ratio (1:2–1.5:1) by varying the inspiratory pause (fig. 1). This alternating breathing pattern causes a variation in  $ET_{CO_2}$  of approximately 0.5–1.0 kPa. Patient flow and expired carbon dioxide are measured by the ordinary Y-piece flow sensor and



**Fig. 1.** (A), The respiratory pattern demonstrating the changes of the inspiratory/expiratory ratio by varying the inspiratory pause in a representative rabbit. (B), Depicts the effects of the varying pause period (dt pause [s]) on the variation in end-tidal carbon dioxide (ETCO<sub>2</sub> [%]).

the main stream carbon dioxide–transducer in Servo-i. Flow and carbon dioxide data from Servo-i are exported, *via* the RS232 port, to a laptop with a specially designed software application written in Matlab™ (Mathworks, Natick, MA).

By measuring and calculating the dynamic transient changes in CO<sub>2</sub> and elimination between each breath it is possible to use the differential Fick method continuously without attaining a new second steady-state condition.<sup>11</sup> The calculation algorithm for ELV is based on the assumptions that both ELV and cardiac output are constant from breath to breath and that C<sub>v</sub>CO<sub>2</sub> (the carbon dioxide content in venous blood) remains constant during 10 breaths cycle.

The equation below describes a mole balance of carbon dioxide in the lung and contains three unknown variables: ELV = effective lung volume, Q<sub>c</sub> = “effective pulmonary capillary blood flow,” and C<sub>v</sub>CO<sub>2</sub> = carbon dioxide content in venous blood. The left side reflects the end-tidal difference

in CO<sub>2</sub> content in the lung between two breaths, and the first term on the right side describes the circulatory supply of carbon dioxide in the alveolar compartment between two breaths. The carbon dioxide content in the lung capillary blood, C<sub>c</sub>CO<sub>2</sub>, is calculated from the alveolar carbon dioxide fraction using the dissociation curve suggested by Capek *et al.*<sup>12</sup> The second term is the amount of carbon dioxide eliminated from the lungs by the nth tidal volume.

$$ELV \times (F_A CO_2^n - F_A CO_2^{n-1}) = Q_c \times \Delta t^n \times (C_v CO_2 - C_c CO_2^n) - VT_{CO_2}^n$$

ELV (l) containing carbon dioxide at end of expiration; n, current breath; n - 1, previous breath; F<sub>A</sub>CO<sub>2</sub>, alveolar carbon dioxide fraction at end of expiration (approximated by ETCO<sub>2</sub>); Q<sub>c</sub>, effective pulmonary blood flow; C<sub>v</sub>CO<sub>2</sub>, venous

carbon dioxide content [ $l_{\text{gas}}/l_{\text{blood}}$ ];  $C_c\text{CO}_2^n$ , lung capillary carbon dioxide content (calculated from  $\text{ETCO}_2$ );  $\text{VT}_{\text{CO}_2}^n$ , volume [ $l$ ] of carbon dioxide eliminated by the current;  $n$ th, breath cycles;  $\Delta t^n$ , current breath cycle time [ $s$ ].

Each of the 10 breaths in the sequence creates a new equation. Thus, 10 breaths create 10 equations with three unknown variables. By optimizing the fit between observed  $F_A\text{CO}_2$  data and calculated  $F_A\text{CO}_2$  according to the abovementioned balance equation, the equation system can be solved. Thus, it is possible to determine ELV, which is the gas volume in the lung at end of expiration including the airway volume up to the location of the carbon dioxide sensor.

### Impedance Measurements

The input impedance spectra of the respiratory system ( $Z_{rs}$ ) in the rabbits was measured using a method previously described.<sup>9,13</sup> In brief, the tracheal cannula was connected to a loudspeaker-in-box system at end expiration, which was pressurized to the level of PEEP during the measurements to maintain the mean transpulmonary pressure constant during measurements. Small-amplitude pseudorandom signal (15 noninteger multiples between 0.5 and 21 Hz) was generated by a loudspeaker and was led through a screen pneumotachograph (11-mm ID) connected to a differential pressure transducer (model 33NA002D; ICSensors, Milpitas, CA) to measure tracheal air flow ( $V'$ ). Another pressure transducer connected to a side-port of the endotracheal tube with identical type was used to measure the airway opening pressure ( $P_{ao}$ ).  $Z_{rs}$  ( $Z_{rs} = P_{ao}/V'$ ) was calculated by Fast Fourier transformation with 4-s time windows and 95% overlapping from the 10-s long recordings.

To separate airway and respiratory tissue mechanics from  $Z_{rs}$  spectra, a model containing frequency-independent airway resistance ( $R_{aw}$ ) and inertance ( $I_{aw}$ ), in series with a constant-phase tissue model<sup>14</sup> including damping ( $G$ ) and elastance ( $H$ ) was fitted to  $Z_{rs}$  by means of a global optimization procedure,<sup>15</sup> which minimized the differences between the measured and modeled impedance values. As previously established,  $R_{aw}$  reflects mainly the flow resistance of the airways,  $I_{aw}$  is related to the cyclic acceleration

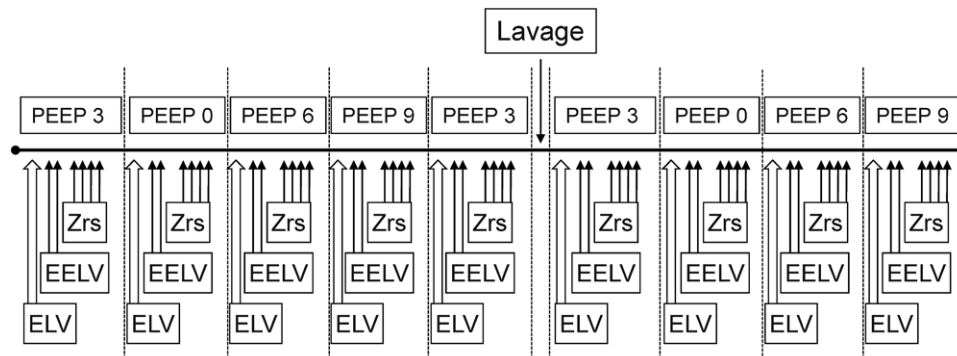
and deceleration of the intrathoracic gas,  $G$  describes the energy loss within the respiratory tissues (resistance) whereas  $H$  characterizes the energy storage capacity of the respiratory tissues (elastance).<sup>14</sup> The reported  $R_{aw}$  and  $I_{aw}$  values were corrected for the resistance and inertance, respectively, of the measurement setup, including the tracheal cannula.

### Study Protocol

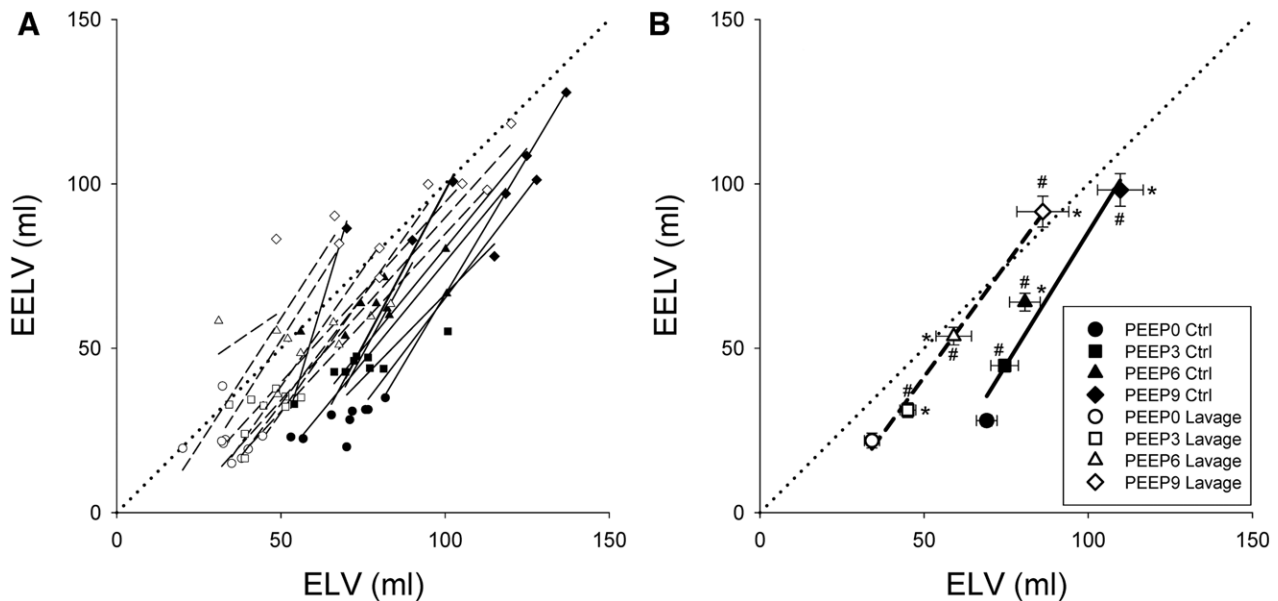
After reaching steady-state conditions in the systemic hemodynamic and ventilation parameters while rabbits were ventilated with PEEP of 3 cm  $\text{H}_2\text{O}$ , a hyperinflation maneuver was performed by superimposing three inspiratory cycles to reach a peak pressure of 30 cm  $\text{H}_2\text{O}$  to standardize the volume history. Continuous measurement of ELV with the Servo-i ventilator was then established for 10 min before recording its steady-state value. Two minutes later, two helium wash-in/wash-out sequences were performed to measure EELV. The lung volume assessments were followed by recording three  $Z_{rs}$  data epochs 2 min apart. The PEEP value was altered to 0, 6, 9, and back to 3 cm  $\text{H}_2\text{O}$  during which the whole sequence was repeated (fig. 2). After completing the measurements under the control condition, surfactant depletion was obtained by instilling warm 0.9% saline (15 ml/kg at 37°C) into the endotracheal cannula. Lung fluid was then withdrawn by gentle manual suctioning. This procedure was repeated twice with the animal being reconnected and ventilated after each maneuver. After lavage,  $\text{FIO}_2$  was increased to 80%, the lung volume standardization maneuver was performed as detailed above and the lung volume and  $Z_{rs}$  measurements were repeated while PEEP levels of 3, 0, 6, and 9 cm  $\text{H}_2\text{O}$  were maintained. This sequence was chosen because it allowed normal ventilation in the initial phase of the experiment (PEEP 3) before inducing derecruitment (PEEP 0) and its subsequent reopening (PEEP 6 and 9).

### Statistical Analyses

Individual data points and group mean averages with SE values are reported. Normality was checked with the Kolmogorov–Smirnov test with Lilliefors correction. Two-way repeated-measures ANOVA was used with the variables PEEP level and lavage to establish the effects of these factors on lung volume



**Fig. 2.** Experimental protocol. EELV = measurement of end-expiratory lung volume by helium wash-out test; ELV = measurement of effective lung volume for gas exchange by capnodynamics; PEEP = positive end-expiratory pressure;  $Z_{rs}$  = measurement of respiratory input impedance with forced oscillations.



**Fig. 3.** Relationships between effective lung volume (ELV) for gas exchange and end-expiratory lung volume (EELV) obtained by helium wash-out with varying positive end-expiratory pressure (PEEP) under the control condition (closed symbols with solid regression lines) and after surfactant depletion (open symbols with dashed regression lines). (A) Values from individual animals. (B) Group means ( $\pm$ SE). \*  $P < 0.05$  versus PEEP 0, #  $P < 0.05$  before versus after surfactant depletion. Dotted lines = lines of identity.

and respiratory mechanical measurements. The Holm–Sidak multiple comparison procedure was used to compare the lung volume and the mechanical parameters under different conditions. Correlation analyses were performed by using a linear mixed model taking into account the multiple observations within animals. Bland–Altman analysis taking into account the multiple observations within an individual animal<sup>16</sup> was performed to determine the agreement between ELV and EELV. The statistical tests were performed with a SigmaPlot (Version 11; Systat Software, Inc. Chicago, IL) and SAS (version 9.2; Cary, NC) statistical software packages. In each test, a significance level of  $P$  value less than 0.05 was applied.

## Results

Measurements performed on healthy lungs revealed significantly greater ELV values than EELV at PEEP 0 ( $150 \pm 13\%$ ;  $P < 0.001$ ), PEEP 3 cm H<sub>2</sub>O ( $66 \pm 4\%$ ;  $P < 0.001$ ), PEEP 6 cm H<sub>2</sub>O ( $26 \pm 5\%$ ;  $P < 0.001$ ) and PEEP 9 cm H<sub>2</sub>O ( $12 \pm 6\%$ ;  $P = 0.004$ ). After lavage, ELV was still significantly higher than EELV at PEEP levels of 0 cm H<sub>2</sub>O ( $66 \pm 18\%$ ;  $P = 0.012$ ) and 3 cm H<sub>2</sub>O ( $50 \pm 13\%$ ;  $P = 0.006$ ), whereas this difference was not detectable after increasing the PEEP level to 6 ( $11 \pm 9\%$ ;  $P = 0.22$ ) and 9 cm H<sub>2</sub>O ( $-6 \pm 6\%$ ;  $P = 0.22$ ).

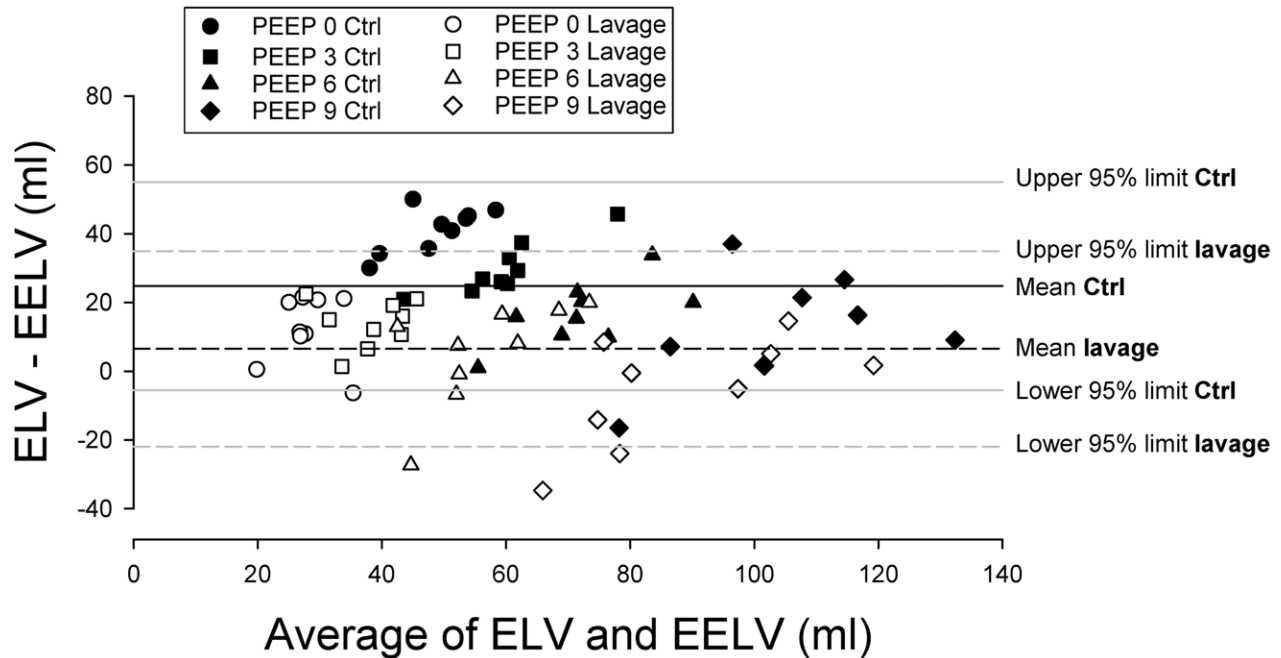
The relationships between the lung volume measurements based on capnodynamics and helium wash-out are given in figure 3. Increasing PEEP led to significant increases in both lung volume indices ( $P < 0.001$  for both). ELV and EELV changed in a similar fashion in the healthy lung ( $r = 0.84$ ;  $P < 0.005$ ), and this correlation became even stronger after surfactant depletion ( $r = 0.86$ ;  $P < 0.003$ ).

The agreements between the two lung volume parameters obtained before and after lung lavage under different

PEEP levels (Bland–Altman plots)<sup>16</sup> are depicted in figure 4. Although ELV remained higher than EELV under the control condition ( $24.8 \pm 15$  [SD] ml), this difference diminished considerably after surfactant depletion ( $6.5 \pm 14$  [SD] ml). The limits of agreement (1.96 SD) were similar before (30.8 ml) and after lavage (28.5 ml), indicating that the difference between the two lung volume parameters was not influenced by the presence of acute lung injury.

Figure 5 summarizes the changes in the lung volume and the respiratory mechanical measurements with PEEP under normal lung conditions and after surfactant depletion. Increasing PEEP caused statistically significant increases in ELV and EELV ( $P < 0.001$  for both), and decreases in LCI ( $P < 0.001$ ). Surfactant depletion did not alter the PEEP-dependent changes in ELV or EELV ( $P = 0.19$  and  $P = 0.1$ ), as it produced a fairly parallel downward shift in both lung volume indices ( $P < 0.001$  for both). However, surfactant depletion had significant effect on the PEEP dependence of LCI ( $P < 0.001$ ) with more pronounced decreases in the diseased condition. Airway and respiratory tissue mechanical parameters decreased with increasing PEEP ( $P < 0.001$  for Raw, G, and H, respectively). Surfactant depletion increased all respiratory mechanical parameters ( $P = 0.037$ ,  $P = 0.013$  and 0.011 for Raw, G, and H, respectively), with these increases effectively counteracted by increasing the PEEP level.

Figure 6 demonstrates the relative changes in the lung volume indices between control and lavage conditions at each PEEP level. The loss of lung volume was reflected in both ELV and EELV after lung lavage, with ELV exhibiting significantly greater changes only at PEEP 0. Increasing PEEP level reduced the lung volume loss after lung lavage, which was manifested more clearly in ELV measurements.



**Fig. 4.** Bland–Altman plots for agreements between effective lung volume (ELV) for gas exchange and end-expiratory lung volume (EELV). Closed symbols represent data points obtained under control conditions at positive end-expiratory pressure (PEEP) 0 (circles), 3 (squares), 6 (triangles), and 9 cm H<sub>2</sub>O (diamonds); open symbols represent data points obtained after surfactant depletion with identical symbols to denote PEEP levels. Thick continuous and dashed lines denote means before and after lavage, respectively. The corresponding thin continuous and dashed lines denote the 95% limits of agreement before and after lavage, respectively.

Figure 7 demonstrates the elastance parameter (H) and LCI as a function of the lung volume indices determined by helium wash-out (fig. 7, A and C) and capnodynamics (fig. 7, B and D). Low lung volumes (<40 ml) determined with either technique were associated with an increased H and LCI and are reflected in the strong correlations between H and EELV ( $r = 0.81$ ;  $P < 0.005$ ), between H and ELV ( $r = 0.83$ ;  $P < 0.00001$ ), between LCI and EELV ( $r = 0.92$ ;  $P < 0.003$ ), and between LCI and ELV ( $r = 0.73$ ;  $P < 0.00001$ ).

## Discussion

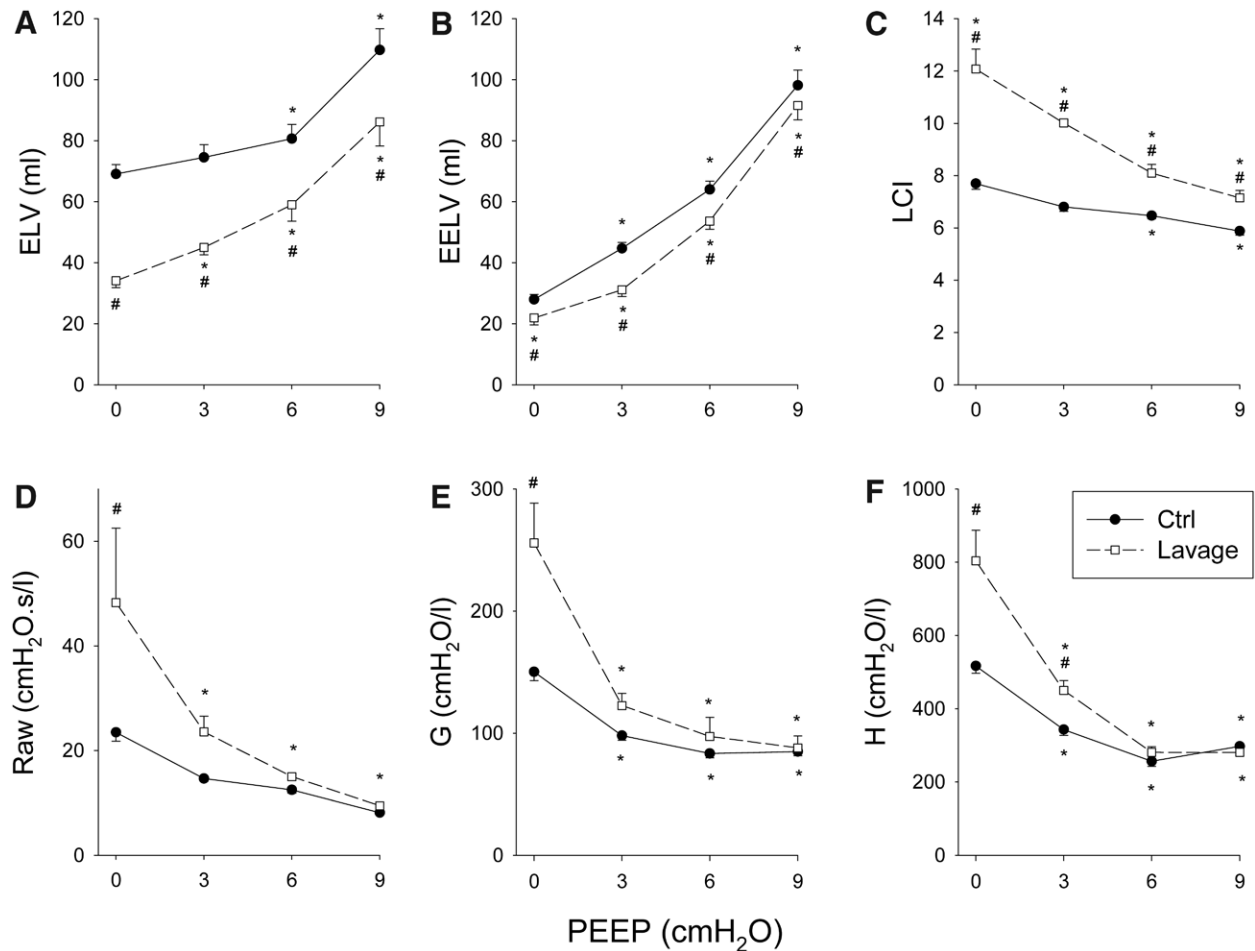
The results of the current study demonstrate the applicability of breath-by-breath analysis of the carbon dioxide after a cyclic alteration of the inspiratory pattern to determine the lung volume of effective gas exchange. Our data suggest the ability of this lung volume parameter, referred as ELV, to follow alterations in the static lung volume (EELV) during changes in PEEP in both healthy lungs and in the presence of acute lung injury. In addition, ELV appears closely correlated to the elastic properties of the respiratory system and to the lung heterogeneity index (LCI), in a similar fashion to those observed with EELV. We believe that ELV reflects changes in the lung volume available for gas exchange in a real-time manner, which has the potential to detect early deteriorations in lung volume, which can occur during mechanical ventilation.

We used a gas wash-out with helium to assess the static EELV under the various experimental conditions. Helium concentrations during the wash-out period of the mechanical ventilation were measured by applying an ultrasonic

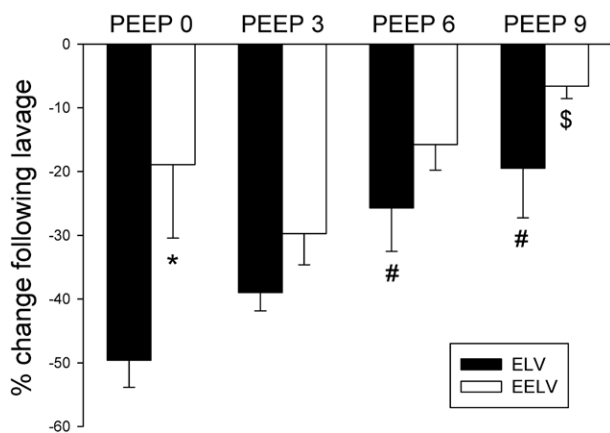
flowmeter. Because this device has been shown to provide accurate and reproducible EELV values,<sup>8,9,17</sup> the EELV values in the current study can be judged as a comparator for ELV measurement and assessment.

To use ELV as a surrogate for EELV is attractive because ELV can be measured in real time using an appropriate ventilator or anesthesia machine without complex additional hardware. Our results demonstrate close associations between ELV and EELV both in healthy lungs and after surfactant depletion (fig. 3). In addition, alterations in respiratory mechanics and ventilation with PEEP were reflected in the changes in ELV (fig. 7), which further demonstrate the value of this parameter to monitor lung function changes in different conditions. ELV appears to consistently overestimate EELV in healthy lungs especially at low PEEP level (<6 cm H<sub>2</sub>O). Applying the ventilation pattern necessary for ELV estimation *per se* does increase the EELV by approximately 11% (data not shown), but this effect may not fully explain the differences observed between the two lung volume indices. However, applying the ventilation pattern with an enhanced end-inspiratory pause may have recruited atelectatic lung areas, particularly after lavage. Moreover, other factors affecting ELV estimates, such as lung capillary blood volume and/or ventilation-perfusion mismatch may be involved.

Unlike helium, which is an extrinsic gas, carbon dioxide differs principally from the common foreign gas wash-in/wash-out methods by the fact that the tracer used to assess the lung volume is supplied to the lung endogenously *via* the blood. The dilution volume of carbon dioxide at a given time will therefore be larger than that of helium because it includes the lung capillary

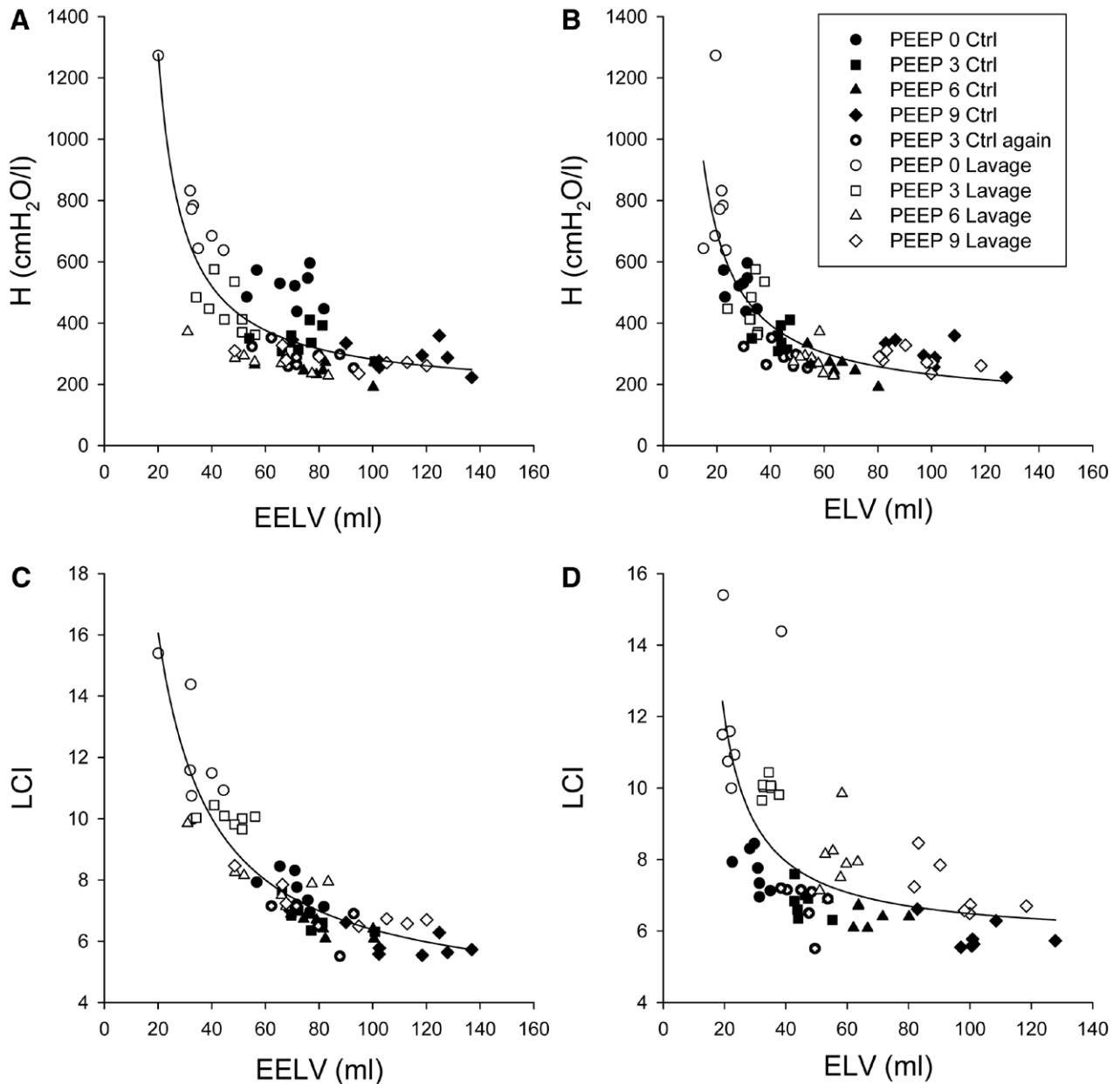


**Fig. 5.** Lung volume (A, B) and LCI (C) and respiratory mechanical parameters (D, E, and F) obtained at different positive end-expiratory pressure (PEEP) levels before (closed symbols) and after (open symbols) surfactant depletion. EELV = end-expiratory lung volume measured by helium wash-out; ELV = effective lung volume for gas exchange determined by capnodynamics; LCI = lung clearance index obtained by helium wash-out; Raw, G, and H = airway resistance, tissue damping, and tissue elastance measured by forced oscillations. \*  $P < 0.05$  versus PEEP 0, #  $P < 0.05$  before versus after surfactant depletion.



**Fig. 6.** Relative changes observed between control condition and after surfactant depletion in effective lung volume (ELV) for gas exchange (filled bars) and end-expiratory lung volume (EELV; hollow bars) with varying positive end-expiratory pressure (PEEP). \*  $P < 0.05$  between ELV and EELV within a PEEP. #  $P < 0.05$  versus PEEP 0; \$  $P < 0.05$  versus PEEP 3.

blood volume and that of the tissues itself. With regard to the effects of lung capillary blood volume, it should be pointed out that the estimation of ELV is based on a method using a single-compartment (gas volume) lung model. In the healthy lung there is a rapid equilibrium between the carbon dioxide concentrations in the alveolar gas and in the capillary blood. The total carbon dioxide content of the lung comprises the sum of the carbon dioxide in the blood and in the alveolar space. Thus, as far as the diffusion capacity is unrestricted, a wash-in/wash-out method based on carbon dioxide as a tracer gas may measure a larger lung volume compared with a method based on nonsoluble tracer gas, such as helium, which solely measures the alveolar gas volume. Indeed, if we assume a solubility of carbon dioxide in rabbit blood of  $0.0025 \text{ ml}_{\text{CO}_2} / \text{ml}_{\text{blood}} / \text{mbar}$ , the observed difference of 40 ml between ELV and EELV at PEEP = 0 corresponds to a pulmonary blood volume of 16 ml. Although there are no data on the value of pulmonary blood volume in rabbits, this volume determined from the exponential decay time from two indicators (indocyanine green and temperature) was shown to be approximately  $4 \text{ ml/kg}^{18,19}$  in



**Fig. 7.** Relationships between end-expiratory lung volume (EELV) and respiratory elastance (A) and lung clearance index (LCI; C), effective lung volume (ELV) for gas exchange and respiratory elastance (B) and LCI (D). Closed symbols represent data points obtained under control conditions at positive end-expiratory pressure (PEEP) 0 (circles), 3 (squares), 6 (triangles), and 9 cm H<sub>2</sub>O (diamonds); open symbols represent data points obtained after surfactant depletion with identical symbols to denote PEEP levels.

humans and 4–6 ml/kg in dogs.<sup>20</sup> Thus, assuming similar figures for pulmonary blood volume in rabbits as in dogs, the additional effect of carbon dioxide from the blood can, at least to some extent, explain the difference between ELV and EELV seen in the control animals at low PEEP level. At higher PEEP levels the lung capillary blood volume is decreased,<sup>20</sup> which may explain the better agreement between ELV and EELV under these conditions. Furthermore, after lavage it is likely that the diffusion is rendered more difficult and the additional effect from lung capillary blood volume will be attenuated. This may explain the better agreement observed between the two methods after surfactant depletion.

Regarding the ventilation-perfusion mismatch, there are two factors that may determine the balance between ventilation and perfusion of the lung. From the circulation side, alterations in effective pulmonary blood flow (Q) will affect ventilation-perfusion mismatch with consequent alteration in the carbon dioxide balance, based on the Fick principle. Considering that the measurement of ELV is primarily based on the breath-by-breath analyses of the tidal carbon dioxide elimination it is a prerequisite that Q can be judged as constant between two breaths. Therefore, slow hemodynamic alterations do not bias the accuracy of the ELV measurement. However, the impact of hemodynamic changes in general on the ELV assessment warrants



further investigations. However, the ventilation distribution, which is the other main determinant of ventilation-perfusion mismatch, may also affect ELV assessment: surfactant deficiency leads to disperse airway closures and air trapping,<sup>21</sup> which subsequently reduces carbon dioxide elimination more profoundly than the static lung volumes such as EELV.<sup>22</sup> This phenomenon may explain reduction of the initial difference between the two volume parameters after lung lavage. ELV estimation is based on carbon dioxide elimination, and is likely to be highly sensitive to airway closure, with subsequent increase in ventilation-perfusion mismatch and a loss of surface area available for gas exchange, due to surfactant depletion. In addition, hypoxic vasoconstriction resulting from airway closure may further contribute to the decrease in ELV estimation. These potential mechanisms may be further potentiated by the postlavage increases in physiological dead space,<sup>23</sup> which may also give greater decreases in ELV than in the static lung volumes. The concomitant presence of these mechanisms is confirmed by the parallel shift in the ELV–EELV relationship after lavage (fig. 5) and by the change in the mean difference between these lung volume indices without an effect on their limits of agreement (fig. 4).

Acute lung injury was modeled in the current study by applying saline lavage that effectively removes the surface-active lining layer in the lung periphery and increases alveolar surface tension leading to geometric alterations in the alveoli.<sup>24,25</sup> This intervention subsequently enhances atelectasis development especially at low PEEP levels and leads to development of ventilation heterogeneity as reflected by the marked increases in LCI. Moreover, this condition also leads to systematic decreases in ELV and EELV, and increases in the airway and respiratory tissue mechanical parameters. In agreement with previous results, increases in PEEP were able to abolish this heterogeneous lung function deterioration.<sup>9,26,27</sup> Accordingly, and in line with earlier findings,<sup>28</sup> increasing PEEP level in the current study improved ventilation distribution, which was reflected in the significant decrease in LCI. Young adult rabbits were studied in the current experiment because their lung size is comparable to a newborn neonate. Although we are aware that this does not form a perfect model for the immature neonatal lung, the ventilation strategy in these small animals is similar to that applied in pediatric clinical practice, which makes it suitable to investigate the effects of PEEP and surfactant depletion on the lung volume and respiratory mechanical indices.

The measurement of ELV is based on analyzing the variation of carbon dioxide levels in the exhaled gas during mechanical ventilation after the application of a periodic pattern consisting of a variable inspiratory/expiratory ratio. This method requires the patient to have no spontaneous breathing efforts (is under controlled mechanical ventilation). This condition is met under general anesthesia in operating theater or in intensive care units where children are under heavy sedation and/or muscle relaxation and where conditions with impaired lung function are commonly observed.

In summary, the results of the current study show that changes in PEEP are reflected in the measures of ELV participating in the

gas exchange. This feature makes ELV a potentially useful bedside tool to estimate dynamic changes in the static lung volumes such as EELV. Changes in lung perfusion should be taken into account when interpreting ELV data in normal lungs particularly at low PEEP level. However, ELV seems to provide consistent information on the lung volume in the presence of acute lung injury with diminished surfactant function. The close association between ELV and the elastic recoil of the respiratory system in addition to the similar pattern of change in ELV and EELV suggests that the former may provide a valuable contribution to monitor changes in the ventilation parameters with PEEP in order to apply a protective and optimal ventilation strategy.

The authors thank Katalin Virág, Ph.D. Student, Department of Medical Physics and Informatics, University of Szeged, Hungary, for help in the statistical analyses.

## References

1. Murat I, Constant I, Maud'huy H: Perioperative anaesthetic morbidity in children: A database of 24,165 anaesthetics over a 30-month period. *Paediatr Anaesth* 2004; 14:158–66
2. Mamie C, Habre W, Delhumeau C, Argiroffo CB, Morabia A: Incidence and risk factors of perioperative respiratory adverse events in children undergoing elective surgery. *Paediatr Anaesth* 2004; 14:218–24
3. von Ungern-Sternberg BS, Boda K, Chambers NA, Rebmann C, Johnson C, Sly PD, Habre W: Risk assessment for respiratory complications in paediatric anaesthesia: A prospective cohort study. *Lancet* 2010; 376:773–83
4. Habre W: Neonatal ventilation. *Best Pract Res Clin Anaesthesiol* 2010; 24:353–64
5. Mansell A, Bryan C, Levison H: Airway closure in children. *J Appl Physiol* 1972; 33:711–4
6. Gedeon A, Krill P, Osterlund B: Pulmonary blood flow (cardiac output) and the effective lung volume determined from a short breath hold using the differential Fick method. *J Clin Monit Comput* 2002; 17:313–21
7. Rylander C, Högman M, Perchiazzi G, Magnusson A, Hedenstierna G: Functional residual capacity and respiratory mechanics as indicators of aeration and collapse in experimental lung injury. *Anesth Analg* 2004; 98:782–9
8. Schibler A, Henning R: Measurement of functional residual capacity in rabbits and children using an ultrasonic flow meter. *Pediatr Res* 2001; 49:581–8
9. Habre W, Scalfaro P, Schütz N, Stucki P, Peták F: Measuring end-expiratory lung volume and pulmonary mechanics to detect early lung function impairment in rabbits. *Respir Physiol Neurobiol* 2006; 152:72–82
10. Robinson RH: Ability to detect changes in compliance and resistance during manual artificial ventilation: A laboratory investigation. *Br J Anaesth* 1968; 40:323–8
11. Peyton PJ, Venkatesan Y, Hood SG, Junor P, May C: Noninvasive, automated and continuous cardiac output monitoring by pulmonary capnodynamics: Breath-by-breath comparison with ultrasonic flow probe. *ANESTHESIOLOGY* 2006; 105:72–80
12. Capek JM, Roy RJ: Noninvasive measurement of cardiac output using partial CO<sub>2</sub> rebreathing. *IEEE Trans Biomed Eng* 1988; 35:653–61
13. Habre W, Babik B, Chalier M, Peták F: Role of endogenous histamine in altered lung mechanics in rabbits. *ANESTHESIOLOGY* 2002; 96:409–15
14. Hantos Z, Daróczy B, Suki B, Nagy S, Fredberg JJ: Input impedance and peripheral inhomogeneity of dog lungs. *J Appl Physiol* 1992; 72:168–78

15. Csendes T: Nonlinear parameter estimation by global optimization—efficiency and reliability. *Acta Cybernet* 1988; 8:361–70
16. Bland JM, Altman DG: Agreement between methods of measurement with multiple observations per individual. *J Biopharm Stat* 2007; 17:571–82
17. Pillow JJ, Ljungberg H, Hülkamp G, Stocks J: Functional residual capacity measurements in healthy infants: Ultrasonic flow meter *versus* a mass spectrometer. *Eur Respir J* 2004; 23:763–8
18. Hachenberg T, Ebel C, Czorny M, Thomas H, Wendt M: Intrathoracic and pulmonary blood volume during CO<sub>2</sub>-pneumoperitoneum in humans. *Acta Anaesthesiol Scand* 1998; 42:794–8
19. Hachenberg T, Tenling A, Rothen HU, Nyström SO, Tyden H, Hedenstierna G: Thoracic intravascular and extravascular fluid volumes in cardiac surgical patients. *ANESTHESIOLOGY* 1993; 79:976–84
20. Slutsky RA: Reduction in pulmonary blood volume during positive end-expiratory pressure. *J Surg Res* 1983; 35:181–7
21. Ellyett KM, Cragg PA, Broadbent RS: Effect of surfactant deficiency and surfactant replacement on airway patency in the piglet lung. *Respir Physiol Neurobiol* 2006; 150:173–81
22. Lichtwarck-Aschoff M, Zimmermann GJ, Erhardt W: Reduced CO<sub>2</sub>-elimination during combined high-frequency ventilation compared to conventional pressure-controlled ventilation in surfactant-deficient piglets. *Acta Anaesthesiol Scand* 1998; 42:335–42
23. Wenzel U, Wauer RR, Wagner MH, Schmalisch G: *In vitro* and *in vivo* assessment of the Ventrak 1550/Capnogard 1265 for single breath carbon dioxide analysis in neonates. *Br J Anaesth* 1999; 83:503–10
24. Clements JA, Hustead RF, Johnson RP, Gribetz I: Pulmonary surface tension and alveolar stability. *J Appl Physiol* 1961; 16:444–50
25. Bachofen H, Gehr P, Weibel ER: Alterations of mechanical properties and morphology in excised rabbit lungs rinsed with a detergent. *J Appl Physiol* 1979; 47:1002–10
26. Barnas GM, Donahue PL, Kong CS, Ryder IG, Choi DH, Hoff BH, Mackenzie CF: Effects of PEEP on acinar gas transfer in healthy and lung-injured dogs. *Am J Respir Crit Care Med* 1995; 152(4 Pt 1):1241–7
27. Larsson A, Gilbert JT, Bunegin L, Gelineau J, Smith RB: Pulmonary effects of body position, PEEP, and surfactant depletion in dogs. *Acta Anaesthesiol Scand* 1992; 36:38–45
28. Schibler A, Henning R: Positive end-expiratory pressure and ventilation inhomogeneity in mechanically ventilated children. *Pediatr Crit Care Med* 2002; 3:124–8

## ANESTHESIOLOGY REFLECTIONS FROM THE WOOD LIBRARY-MUSEUM

### How Pan's Rejection Led to the Syringe's Injection



As she fled the amorous satyr Pan, a chaste wood nymph named Syrinx rushed up to the River Ladon's edge (*left*) and prayed for rescue. Her "watery sisters," the river nymphs, transformed her into river reeds (*syringes*, in Greek), which piped out plaintive, hollow tunes with each of Pan's lecherous sighs. Clutching the reeds, Pan wove them into the raft-like Pan's pipe (*high right*), a musical instrument also known as the syrxinx. So reeds (of different length) in parallel formed this musical syrxinx; reeds (of different diameters) in series formed the aspirating syringe (*low right*), which needed only the hollow needle's invention for use as an injector. And that is how Pan's rejection led to the syringe's invention ... and injection. (The image on the left is adapted from the author's print of Michel Dorigny's *Pan et Syrinx*.) (Copyright © the American Society of Anesthesiologists, Inc.)

George S. Bause, M.D., M.P.H., Honorary Curator, ASA's Wood Library-Museum of Anesthesiology, Park Ridge, Illinois, and Clinical Associate Professor, Case Western Reserve University, Cleveland, Ohio. UJYC@aol.com.