

# Effect of Thoracic Epidural Anesthesia on Ventricular Excitability in a Porcine Model

Kimberly Howard-Quijano, M.D., M.S., Tatsuo Takamiya, M.D., Erica A. Dale, Ph.D., Kentaro Yamakawa, M.D., Wei Zhou, Ph.D., Una Buckley, M.D., Aman Mahajan, M.D., Ph.D.

## ABSTRACT

**Background:** Imbalances in the autonomic nervous system, namely, excessive sympathoexcitation, contribute to ventricular tachyarrhythmias. While thoracic epidural anesthesia clinically suppresses ventricular tachyarrhythmias, its effects on global and regional ventricular electrophysiology and electrical wave stability have not been fully characterized. The authors hypothesized that thoracic epidural anesthesia attenuates myocardial excitability and the proarrhythmic effects of sympathetic hyperactivity.

**Methods:** Yorkshire pigs ( $n = 15$ ) had an epidural catheter inserted (T1 to T4) and a 56-electrode sock placed on the heart. Myocardial excitability was measured by activation recovery interval, dispersion of repolarization, and action potential duration restitution at baseline and during programmed ventricular extrastimulation or left stellate ganglion stimulation, before and 30 min after thoracic epidural anesthesia (0.25% bupivacaine).

**Results:** After thoracic epidural anesthesia infusion, there was no change in baseline activation recovery interval or dispersion of repolarization. During programmed ventricular extrastimulation, thoracic epidural anesthesia decreased the maximum slope of ventricular electrical restitution ( $0.70 \pm 0.24$  vs.  $0.89 \pm 0.24$ ;  $P = 0.021$ ) reflecting improved electrical wave stability. Thoracic epidural anesthesia also reduced myocardial excitability during left stellate ganglion stimulation-induced sympathoexcitation through attenuated shortening of activation recovery interval ( $-7 \pm 4\%$  vs.  $-4 \pm 3\%$ ;  $P = 0.001$ ), suppression of the increase in dispersion of repolarization ( $313 \pm 293\%$  vs.  $185 \pm 234\%$ ;  $P = 0.029$ ), and reduction in sympathovagal imbalance as measured by heart rate variability.

**Conclusions:** Our study describes the electrophysiologic mechanisms underlying antiarrhythmic effects of thoracic epidural anesthesia during sympathetic hyperactivity. Thoracic epidural anesthesia attenuates ventricular myocardial excitability and induces electrical wave stability through its effects on activation recovery interval, dispersion of repolarization, and the action potential duration restitution slope. (**ANESTHESIOLOGY 2017; 126:1096-106**)

IMBALANCES in the autonomic nervous system and sympathetic hyperexcitability are major contributors to the pathophysiology of ventricular tachyarrhythmias.<sup>1,2</sup> The spinal cord is a critical integrative site within the cardiac autonomic hierarchy,<sup>3,4</sup> and selective neuraxial modulation, including pharmacologic approaches at this level, can provide an effective therapy for ventricular tachyarrhythmias.<sup>5,6</sup> Thoracic epidural anesthesia (TEA) modulates autonomic balance by inhibiting afferent signaling and efferent outflow between the heart and spinal cord, *via* blockade of neural activity of spinal nerve rootlets in the epidural space.<sup>4,7,8</sup> In both clinical and experimental models, TEA has been shown to attenuate ventricular arrhythmogenesis and decrease myocardial infarcts.<sup>5,9-20</sup>

While the cardioprotective benefits of TEA have been reported,<sup>5,9-20</sup> its effect on global and regional ventricular electrophysiology that confer antiarrhythmic properties has not been characterized during sympathetic hyperactivity states predisposed to ventricular tachyarrhythmias.

### What We Already Know about This Topic

- Arrhythmias are a major source of perioperative morbidity and mortality and are connected to imbalances in the autonomic nervous system control
- Thoracic epidural anesthesia suppresses ventricular tachyarrhythmias, although the mechanism for the suppression has not been well characterized

### What This Article Tells Us That Is New

- A porcine animal model was used to characterize the effects of thoracic epidural anesthesia on sympathetic stimulation and critical parameters of cardiac excitability
- Thoracic epidural anesthesia reduced ventricular excitability and the proarrhythmic effects of sympathetic hyperactivity
- The study adds important mechanistic insight to support the treatment of ventricular arrhythmias by thoracic epidural anesthesia

Mechanistic understanding of electrical wave dynamics in myocardial tissue can be obtained by recording the action potential duration (APD), APD restitution, and dispersion

This article is featured in "This Month in Anesthesiology," page 1A. This article has a video abstract.

Submitted for publication September 20, 2016. Accepted for publication January 31, 2017. From the Department of Anesthesiology and Perioperative Medicine (K.H.-Q., T.T., E.A.D., K.Y., W.Z., A.M.), UCLA Cardiac Arrhythmia Center (U.B., A.M.), and UCLA Neurocardiology Research Center of Excellence, David Geffen School of Medicine (K.H.-Q., U.B., A.M.), University of California, Los Angeles (UCLA), Los Angeles, California.

Copyright © 2017, the American Society of Anesthesiologists, Inc. Wolters Kluwer Health, Inc. All Rights Reserved. Anesthesiology 2017; 126:1096-106

of repolarization: electrophysiologic measures that are important determinants of ventricular excitability, wave stability, and arrhythmogenesis.<sup>21–26</sup>

The primary aim of this study was to examine the electrophysiologic mechanisms underlying antiarrhythmic effects of TEA during sympathetic hyperactivity. We investigated the effect of TEA (T1 to T4) on ventricular electrophysiology at baseline and in response to sympathetic hyperactivity using high-resolution, high-fidelity cardiac electrophysiology mapping with the measurement of activation recovery intervals, dispersion of repolarization, and APD restitution. Stellate ganglion stimulation greatly enhances sympathetic outflow to the heart creating a proarrhythmic substrate that has been shown to induce ventricular tachyarrhythmias,<sup>26–28</sup> thus providing a unique model to evaluate the effects of TEA on myocardial excitability. We hypothesized that TEA attenuates myocardial excitability and the proarrhythmic effects of sympathetic stimulation. These data can provide better insight into the therapeutic effects of TEA on ventricular arrhythmias and aid in development of future treatment modalities.

## Materials and Methods

All animal studies were performed in accordance with guidelines of the University of California Institutional Animal Care and Use Committee (Los Angeles, California) and the National Institutes of Health (Bethesda, Maryland) Guide for the Care and Use of Laboratory Animals (Pub. No. 85-23, Revised 1996). In order to test the hypothesis that TEA would suppress myocardial excitability through thoracic spinal autonomic modulation of cardiac spinal reflexes, cardiac electrophysiology mapping was performed at baseline and in response to two experimental protocols (programmed ventricular extrastimulation and left stellate ganglion stimulation [LSS]) before and after TEA. Yorkshire pigs  $n = 15$  (male or female), weighing 38 to 49 kg, were anesthetized and randomized to either the programmed ventricular extrastimulation ( $n = 7$ ) or stellate stimulation ( $n = 8$ ) protocols, and each protocol was performed pre- and post-TEA (fig. 1). Experimental protocols were performed before and 30 min after TEA so that each animal could serve as its own control and decrease the effect of interanimal variability. Adequate time was given between conditions for hemodynamic and electrophysiologic measures to return to

baseline between interventions. All hemodynamic and electrophysiologic measures, as well as data analysis, were done off-line by experts blinded to study group and condition.

## Anesthesia and Surgical Preparation

Animals were sedated with telazol (4 to 8 mg/kg, intramuscular), intubated, and mechanically ventilated. General anesthesia consisted of isoflurane (1 to 2.5% inhalation) during surgical preparation. Surface 12-lead electrocardiogram was monitored using a Prucka CardioLab recording system (GE Healthcare, USA). The femoral artery and vein were catheterized for monitoring of arterial blood pressure, intravenous saline infusion (10 ml/kg), and drug administration. In order to maintain acid–base equilibrium, arterial blood gas was tested hourly with adjustment of ventilation or administration of sodium bicarbonate as necessary. A thoracic epidural catheter was inserted in the right lateral position. After a small incision at the T-7/8 level, an 18-gauge Tuohy needle was inserted into the epidural space using the loss of resistance technique. The distal end of the epidural catheter was placed at T1. A median sternotomy was subsequently performed in the supine position. The left stellate ganglion was isolated, and the pericardium was opened to expose the heart. After the completion of surgical preparation, general anesthesia was transitioned to intravenous  $\alpha$ -chloralose (50 mg/kg initial bolus followed by a  $20 \text{ mg} \cdot \text{kg}^{-1} \cdot \text{h}^{-1}$  continuous infusion), and animals were allowed to stabilize for 1 h. Use of intravenous  $\alpha$ -chloralose as an anesthetic has been previously shown to be least disruptive of autonomic nervous system activity and has been used extensively in investigational studies.<sup>29</sup> Animals were euthanized by intravenous administration of a lethal dose of potassium chloride and sodium pentobarbital (100 mg/kg).

## Thoracic Epidural Anesthesia

Local anesthesia with 0.25% bupivacaine (0.7 mg/kg) and 0.1 ml dye was injected *via* an epidural catheter with the tip at the T1/T2 level over 1 min. Bupivacaine dose of 0.7 mg/kg was used to minimize hemodynamic side effects while being able to block sympathetic activity from stellate stimulation.<sup>17</sup> Epidural bupivacaine has an average onset of  $23 \pm 5$  min and a duration of  $165 \pm 20$  min.<sup>30</sup> Therefore, to ensure adequate bupivacaine blockade, protocol interventions were started 30 min after bupivacaine injection and were completed within less than 60 min. Programmed ventricular extrastimulation

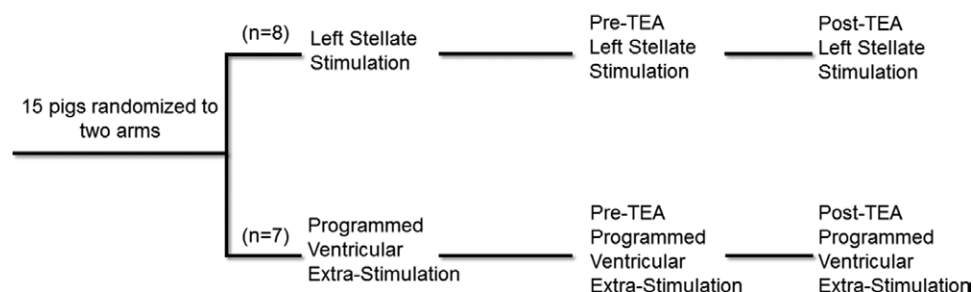

**Fig. 1.** Fifteen Yorkshire pigs were randomized to two treatment protocols: left stellate stimulation or programmed ventricular extrastimulation with or without thoracic epidural anesthesia (TEA) administration.

and LSS were performed before and after TEA as outlined below. At the end of the experiment, a laminectomy was performed to assess catheter location and drug distribution by the presence of the injected dye. In all cases, the distal end of the epidural catheter was successfully placed between the T1 and T2 levels, and drug diffusion was confirmed *via* bupivacaine/dye injection from T1 to T5.

### Experimental Protocols

**Arrhythmogenic Substrate Assessment: Programmed Ventricular Extrastimulation.** Epicardial pacing of the ventricle with programmed extrastimulation (S1 then S2 protocol) was used to create myocardial stress and test ventricular arrhythmogenicity.<sup>31</sup> Briefly, a drive train (S1) consisting of eight paced beats at a cycle length equivalent to 80% of the baseline cycle length was initiated. The ninth beat, an extrastimulus beat, was introduced at 60% of the baseline cycle length, and progressively shortened by 10 ms until effective refractory period (ERP) was reached. ERP was defined as the longest coupling interval that failed to capture the ventricles. Timings of the beginning of the S<sub>1</sub> and S<sub>2</sub> signals were noted, and the delays from the pacing stimuli were measured. Global activation recovery (APD) and diastolic intervals were measured, and electrical restitution curves were composed.

**Stellate Ganglion Stimulation.** We have previously demonstrated LSS as a reliable model for sympathetic hyperactivity and inducing ventricular tachyarrhythmia.<sup>26,27</sup> We performed left stellate, as opposed to right stellate ganglion stimulation, because LSS is associated with increased electrical dispersion and ventricular arrhythmia inducibility.<sup>27</sup> LSS was performed using bipolar needle electrodes. Square stimulation pulses were delivered at 4 ms in duration at 4 Hz *via* a Grass S88 Stimulator (Grass Co., USA). Stimulation threshold was defined as the strength of stimulation current, which elicited a 10% increase in left ventricular systolic pressure. Thereafter, stimulus intensity was increased to 1.5 times the threshold for all subsequent stellate stimulations.

### Hemodynamic Assessment

To measure left ventricular pressure throughout the experiment, a 12-pole conductance pressure–volume pigtail catheter (5 French) was inserted into the left ventricle *via* the left carotid artery and connected to an MPVS Ultra Pressure Volume Loop System (Millar Instruments, USA). Catheter placement was confirmed using epicardial echocardiographic guidance. Heart rate, left ventricular systolic pressure, and maximum and minimum rate rise of left ventricular pressure (dP/dt max, dP/dt min) were measured in all protocols.

### Electrophysiologic Recordings and Analysis

**Activation Recovery Interval and Dispersion of Repolarization.** Activation recovery interval was calculated simultaneously from multiple electrodes on the heart as a measure of APD (fig. 2A). Activation recovery interval has been corroborated to be a reliable measure for APD by use of simultaneously acquired intracellular recordings and mono-APD recordings and has been validated in both animal models and humans.<sup>23,32–36</sup> A custom 56-electrode epicardial sock was placed around the heart to acquire unipolar ventricular epicardial electrograms recorded by a Prucka CardioLab system (GE Healthcare). Activation recovery intervals were analyzed using the customized software iScalDyn (University of Utah, USA) as described previously.<sup>26,37</sup> Briefly, activation recovery interval is measured as the time between the maximum negative dV/dt of the activation signal and the maximum positive dV/dt of the repolarization wave in local epicardial electrograms (fig. 2B). Using the onset of the QRS complex, activation time was measured as the minimum dV/dt and repolarization time as the maximum dV/dt in the T wave. Activation recovery intervals were then calculated by subtracting the activation time from the recovery time. Whole heart activation recovery interval and regional activation recovery interval were analyzed by calculating the average of 5 to 6 electrodes at the left ventricular apex; left and right ventricular anterior, lateral, and posterior walls; and the right ventricular outflow tract. Whole heart epicardial

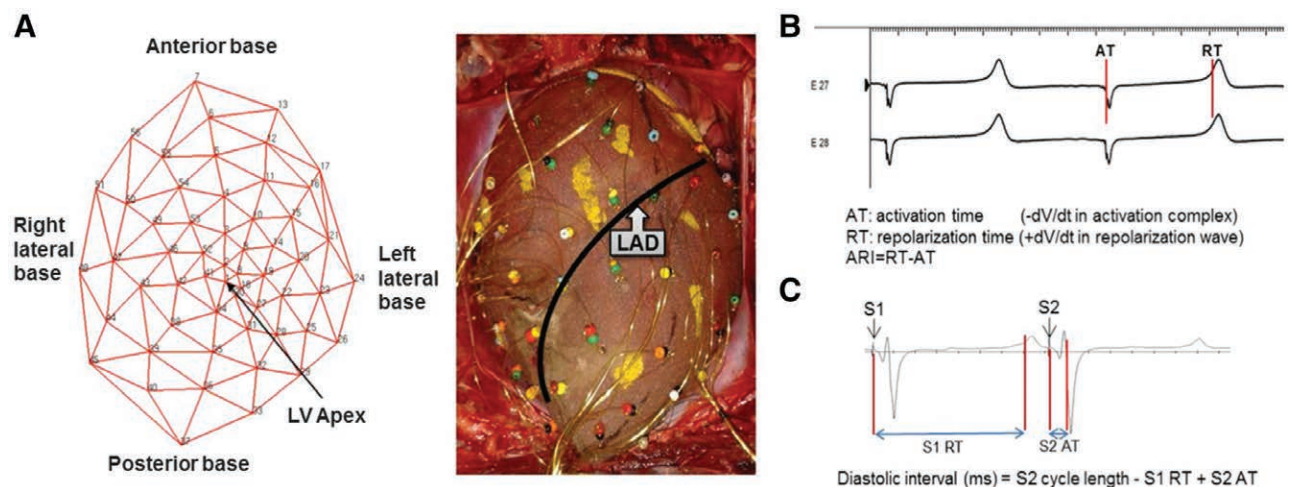

**Fig. 2.** (A) Cardiac surface 56 electrograms, (B) activation recovery interval (ATI), (C) diastolic interval. AT = activation time; LAD = left anterior descending; LV = left ventricular; RT = repolarization time.

dispersion of repolarization was calculated using the variance of all 56-electrode activation recovery intervals. Epicardial dispersion is associated with heterogeneity of repolarization time and increased risk for ventricular arrhythmias.<sup>26</sup> Sympathetic stimulation is associated with shortened activation recovery interval duration and increased dispersion of repolarization.

**Electrical Restitution.** Global activation recovery and diastolic intervals were measured, electrical restitution curves were composed, and maximum steep slope ( $S_{\max}$ ) was calculated using a logarithmic approximation approach.<sup>38</sup> (fig. 2, B and C) The maximum slope of restitution ( $S_{\max}$ ) was measured by analyzing the first derivative of the fitted curve. The restitution hypothesis suggests that wave breaks are more likely to occur at a steeper slope of the restitution curve.<sup>38,39</sup>

**Heart Rate Variability Analysis.** The electrocardiographic signal was continuously recorded by an MPVS Ultra Pressure Volume Loop System (Millar Instruments). Power spectral analysis of the R–R interval variability was performed using Lab Chart 8 (AD Instruments, USA). The low-frequency (LF) component was calculated as the power within the frequency of 0.04 to 0.15 Hz and the high-frequency (HF) component as the power within the frequency range of 0.15 to 0.4 Hz.<sup>22</sup> The power of the LF and HF components was calculated separately for baseline and LSS, pre- and post-TEA. The LF/HF ratio is a measure of autonomic or sympathovagal balance.<sup>22</sup> Increase in the LF component is associated with increased sympathoexcitation, whereas increase in the HF component represents increased vagal activity.<sup>40</sup>

### Statistical Analysis

Data are reported as mean  $\pm$  SD. One-way repeated-measures ANOVA followed by Student–Neumann–Keuls *post hoc* test for multiple hypotheses was performed to compare the change in activation recovery interval, dispersion of repolarization, heart rate variability, and hemodynamic changes from baseline, for each experimental protocol, pre- and post-TEA. All analyses were performed from baseline to intervention (LSS and programmed ventricular extrastimulation) comparing pre- versus post-TEA within each group. There were no planned comparisons between intervention groups. Paired *t* tests were used to compare global ventricular  $S_{\max}$  and ERP pre- and post-TEA. Analysis was performed using Sigma Plot (version 12.5; Systat Software, USA). Data were considered statistically significant with two-tailed  $P < 0.05$ . No *a priori* power calculation was performed; sample size in each group was based on previous experience with this experimental model and design.

## Results

### Electrophysiologic and Hemodynamic Changes Associated with TEA

Complete data sets were obtained for all 15 animals. To evaluate the change in baseline cardiac electrophysiology after TEA, activation recovery interval, dispersion of repolarization, and hemodynamics were measured prebupivacaine injection and 30 min postbupivacaine injection into the

epidural space. Global ventricular excitability as measured by activation recovery interval and dispersion of repolarization was unchanged after TEA (fig. 3, A and B;  $P = 0.37$  and  $P = 0.47$ , respectively). Regionally, there was no difference in activation recovery interval in either the left or right ventricle after TEA (fig. 3C; all  $P \geq 0.63$ ). Blood pressure was reduced (systolic pressure,  $125 \pm 18$  to  $116 \pm 16$  mmHg;  $P = 0.003$ ; mean arterial pressure  $99 \pm 19$  to  $91 \pm 17$  mmHg;  $P = 0.001$ ), while all other hemodynamic measurements showed no significant change 30 min post-TEA; heart rate ( $73 \pm 8$  to  $73 \pm 10$  beats/min;  $P = 0.59$ ), left ventricular systolic pressure ( $103 \pm 11$  to  $98 \pm 12$  mmHg;  $P = 0.15$ ), dP/dt max ( $1,765 \pm 228$  to  $1,727 \pm 306$  mmHg/s;  $P = 0.43$ ), and dP/dt min ( $-1,869 \pm 635$  to  $-1,710 \pm 210$  mmHg/s;  $P = 0.10$ ).

### Change in Ventricular Arrhythmogenic Potential with TEA

During programmed ventricular extrastimulation at S1 cycle length of 500 ms, the ERP was prolonged post-TEA (pre-TEA,  $315 \pm 34$  vs. post-TEA,  $323 \pm 35$  ms;  $P = 0.042$ ). The maximum slope of the electrical restitution curve is a measure of myocardial arrhythmogenic potential, with greater slopes indicating higher risk of ventricular arrhythmogenesis.  $S_{\max}$  of global restitution curve was decreased after TEA ( $0.70 \pm 0.24$  vs.  $0.89 \pm 0.24$ , respectively;  $P = 0.021$ ; fig. 4, A and B).

### Effect of Sympathetic Nerve Stimulation with or without TEA

LSS is a reliable method to increase sympathetic output with subsequent increases in myocardial sympathoexcitation and left ventricular inotropy.<sup>26,27</sup> All eight animals responded to LSS, and stimulation current was set to  $8 \pm 1$  mA. During LSS, an expected increase in left ventricular systolic pressure, systolic blood pressure, and dP/dt max were observed during stellate stimulation, with no change in heart rate (table 1).

Pre- and post-TEA, global ventricular mean activation recovery interval shortened with LSS (pre-TEA,  $392 \pm 17$  to  $365 \pm 15$  ms;  $P < 0.001$  and post-TEA,  $397 \pm 29$  to  $380 \pm 25$  ms;  $P = 0.005$ ; fig. 5A). However, after TEA, the magnitude of global ventricular activation recovery interval shortening by LSS was attenuated ( $-7 \pm 4$  vs.  $-4 \pm 3\%$ ;  $P < 0.009$ ; fig. 5B). APD (activation recovery interval) is affected by changes in activation time and/or repolarization time. There was no difference in the magnitude of activation time change pre- or post-TEA (pre-TEA,  $-2 \pm 2\%$  vs. post-TEA  $-1 \pm 1\%$ ;  $P = 0.06$ ). However, the change in repolarization time was reduced post-TEA (pre-TEA,  $-7 \pm 4\%$  vs. post-TEA,  $-4 \pm 3\%$ ;  $P = 0.008$ ; table 2). Thus, the attenuation in LSS-induced activation recovery interval shortening after TEA may be due to a reduction in repolarization time. LSS also increased dispersion of repolarization both pre-TEA ( $511 \pm 255$  to  $1,725 \pm 622$  ms;  $P = 0.001$ ) and post-TEA ( $518 \pm 280$  to  $1,139 \pm 600$ ;  $P = 0.021$ ) conditions, but after TEA, the magnitude of increase in dispersion of repolarization by LSS was suppressed ( $313 \pm 293\%$  vs.  $185 \pm 234\%$ ;  $P = 0.029$ ; figs. 6 and 7).

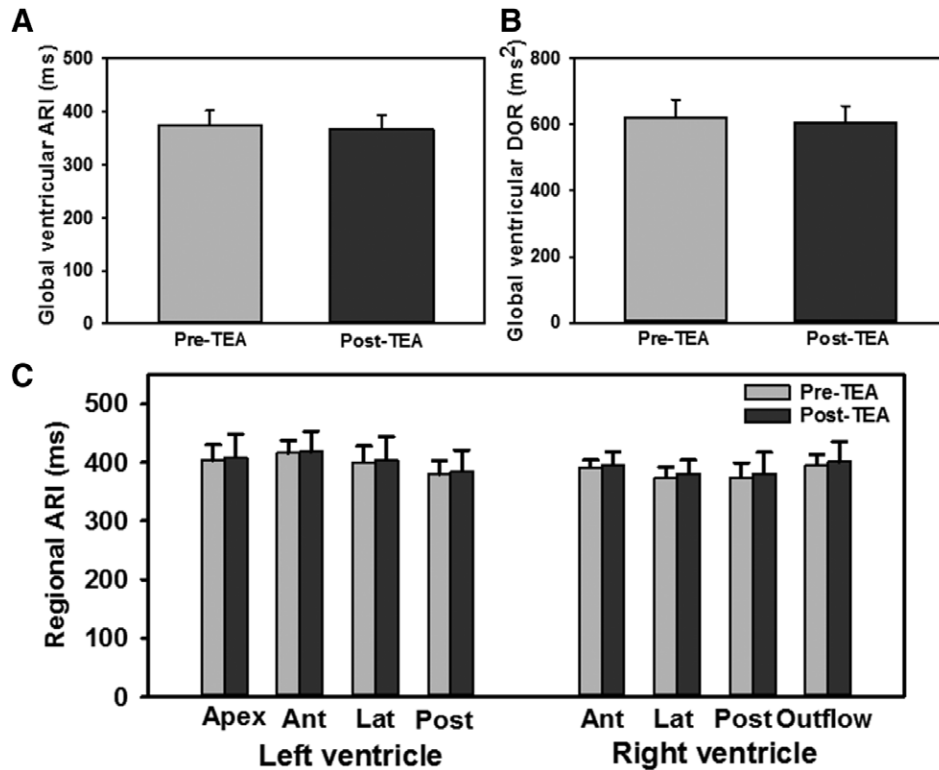

**Fig. 3.** There is no change in (A) global activation recovery intervals (ARI;  $P = 0.37$ ), (B) global ventricular dispersion of repolarization (DOR;  $P = 0.47$ ), or (C) regional ARI after 30 min of thoracic epidural anesthesia (TEA; all  $P \geq 0.63$ ).  $n = 15$ . Ant = anterior left or right ventricle; Apex = left ventricular apex; Lat = lateral left or right ventricle; Outflow = right ventricular outflow tract; Post = posterior left or right ventricle.

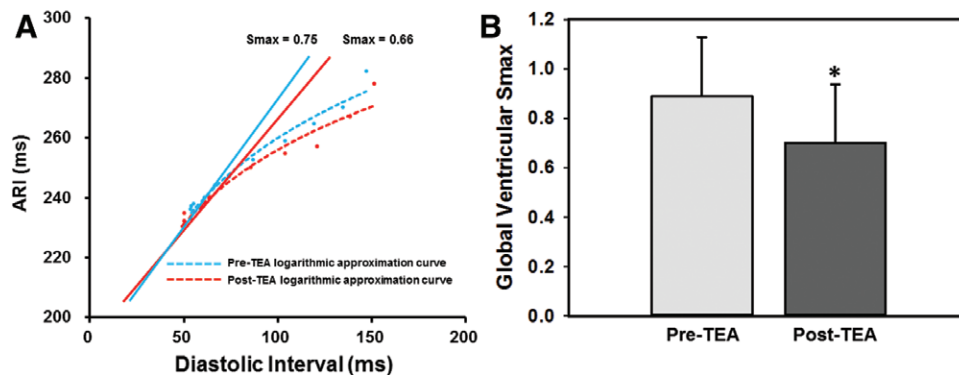

**Fig. 4.** Electrical restitution. (A) Representative global ventricular restitution curve showing decreased maximum slope ( $S_{max}$ ) after 30-min thoracic epidural anesthesia (TEA) compared to pre-TEA. (B) Reduction in mean  $S_{max}$  after 30-min TEA.  $*P = 0.021$  versus pre-TEA.  $n = 7$ . ARI = activation recovery interval.

Heart rate variability can give insight into the autonomic balance between sympathetic and vagal influences, and an increase in LF/HF ratio is associated with sympathoexcitation. LF/HF ratio increased with LSS pre-TEA ( $0.70 \pm 0.58$  to  $1.46 \pm 0.87$ ;  $P = 0.043$ ); however, there was no change in LF/HF ratio with LSS post-TEA ( $0.36 \pm 0.21$  to  $0.63 \pm 0.26$ ;  $P = 0.55$ ; fig. 8). The LF/HF ratio with LSS after TEA was significantly less as compared to pre-TEA ( $1.45 \pm 0.87$  to  $0.63 \pm 0.26$ ;  $P = 0.030$ ). There was no difference in the magnitude of hemodynamic response

to LSS (heart rate, left ventricular systolic pressure,  $dP/dt$  max/min, or heart rate) pre- versus post-TEA (table 1).

## Discussion

In this study, we demonstrated that TEA suppresses ventricular myocardial excitability and decreases ventricular arrhythmogenesis during excessive sympathetic states. Our major findings are: (1) there was no significant change in baseline ventricular activation recovery interval or dispersion of repolarization with TEA and (2) during myocardial stress, TEA (a) decreased the

**Table 1.** Hemodynamic Changes Associated with TEA and LSS

	Pre-TEA		Post-TEA	
	Baseline	LSS	Baseline	LSS
HR, beats/min	75 ± 8	75 ± 8	74 ± 11	72 ± 13
LVSP, mmHg	117 ± 20	127 ± 20*	111 ± 15	118 ± 14*
sBP, mmHg	121 ± 22	139 ± 22*	114 ± 14	128 ± 14*
dP/dt max, mmHg/s	1,974 ± 468	3,007 ± 629*	1,703 ± 294	2,605 ± 309*
dP/dt min, mmHg/s	-1,594 ± 556	-876 ± 287*	-1,435 ± 499	-772 ± 242*

\*Change from baseline, all  $P < 0.001$ .

HR = heart rate; LSS = left stellate ganglion stimulation; LVSP = left ventricular systolic pressure; sBP = systolic blood pressure; TEA = thoracic epidural anesthesia (T1 to T4).

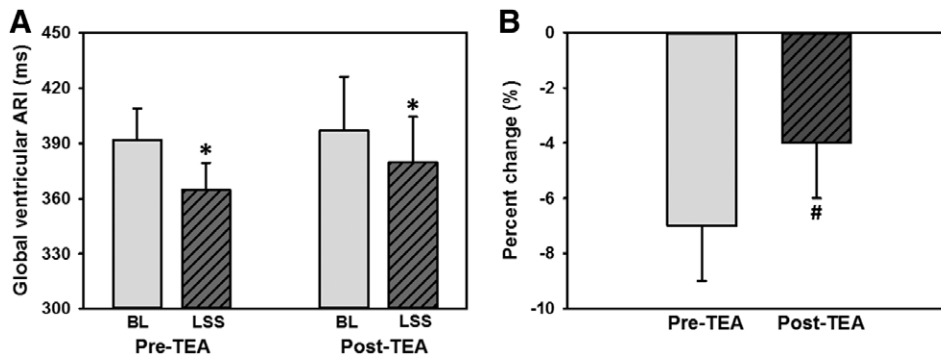

**Fig. 5.** Change in global ventricular activation recovery interval (ARI). (A) ARI was reduced by left stellate ganglion stimulation (LSS) pre-thoracic epidural anesthesia (TEA) but that reduction was attenuated post-TEA. (B) Reduction in magnitude of ARI in pre-TEA versus post-TEA treatment. \*All  $P < 0.005$  versus baseline (BL), # $P = 0.001$  versus pre-TEA.  $n = 8$ .

**Table 2.** Electrophysiologic Changes Associated with TEA and LSS

	Pre-TEA			Post-TEA		
	Baseline	LSS	% Change	Baseline	LSS	% Change
Repolarization time	417 ± 17	389 ± 15*	-7 ± 4%	422 ± 29	404 ± 25*	-4 ± 3%†
Activation time	25 ± 2	25 ± 2	-2 ± 2%	25 ± 2	25 ± 2	-1 ± 1%
ARI	392 ± 17	365 ± 15*	-7 ± 4%	397 ± 29	380 ± 25*	-4 ± 3%†

\*All  $P < 0.035$  versus baseline. † $P < 0.008$  pre-thoracic epidural anesthesia (T1 to T4) (TEA) versus post-TEA.

ARI = activation recovery interval; LSS = left stellate ganglion stimulation.

maximum slope of ventricular electrical restitution, reflecting improved electrical wave stability, (b) attenuated the shortening of ventricular activation recovery interval during stellate stimulation, (c) suppressed the increase in spatial dispersion of repolarization during stellate stimulation, and (d) reduced sympathoexcitation-induced heart rate variability. The ability to simultaneously record epicardial electrical activity in all the regions of the heart using high-fidelity mapping techniques allowed comprehensive assessment of electrophysiologic effects of TEA and its therapeutic potential.

### Effect of TEA on Global and Regional Ventricular Electrophysiology

Our results show that TEA did not alter baseline global or regional ventricular measures of electrical stability. This is important since sympathetic innervation of the heart is non-uniform. For instance, the base of the heart has been shown

to have a greater density of sympathetic activity/innervations as compared to the apex.<sup>26</sup> Additional heterogeneity is created by the differential innervation provided by both right or the left stellate ganglia to left ventricle and right ventricle.<sup>27</sup> Interventions or therapies that significantly prolong APD (or QTc) have been shown to be proarrhythmic, especially if the electrical changes are variable across the different regions of the heart.<sup>26-28</sup> Therefore, any further imbalances can create increased dispersion of repolarization and present a myocardial substrate at risk for reentrant arrhythmias, which account for 80% of all ventricular tachyarrhythmias seen clinically.<sup>41</sup> In our study, the baseline global activation recovery interval (APD), regional activation recovery interval, and dispersion of repolarization did not change after institution of TEA block. Thus, the sympathetic blockade from TEA did not worsen electrical heterogeneity in the right ventricle or left ventricle and likely has minimal cardiac proarrhythmic effects.

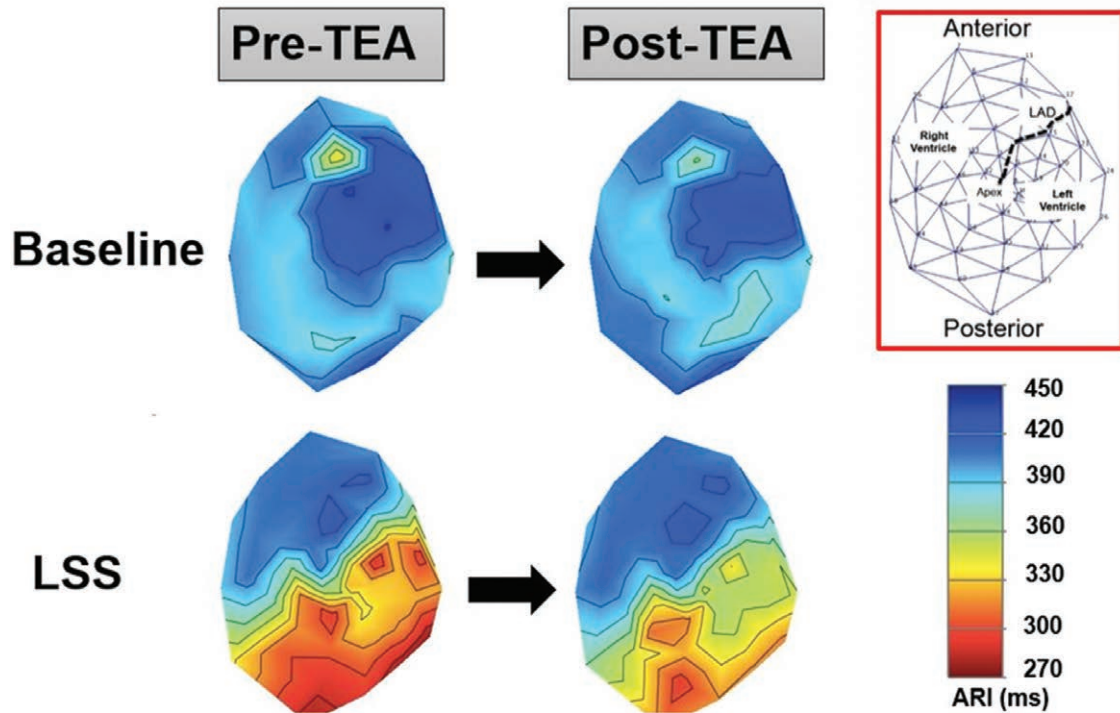

**Fig. 6.** Effects of thoracic epidural anesthesia (TEA) on electrical wave dynamics and dispersion of repolarization in a representative animal. *Top*, Polar maps of activation recovery interval (ARI) at baseline are unchanged pre- and post-TEA. *Bottom*, ARI heterogeneity or dispersion of repolarization is greatly increased with left stellate stimulation (LSS); however TEA attenuates ARI dispersion. LAD = left anterior descending.

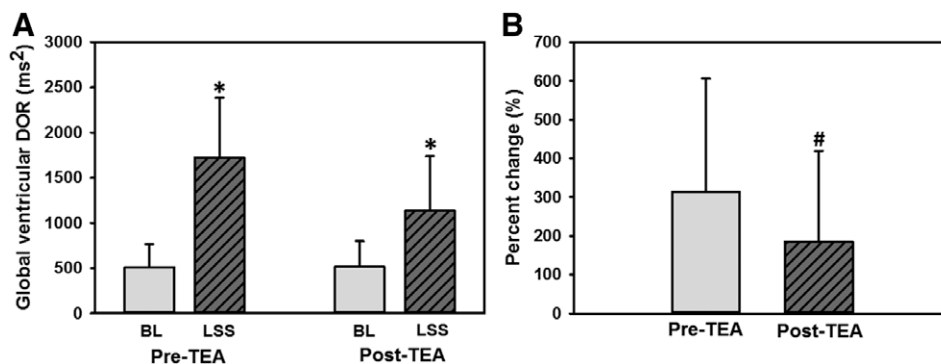

**Fig. 7.** Change in ventricular dispersion of repolarization (DOR). (A) Left stellate stimulation (LSS) increases ventricular DOR both pre- and post-thoracic epidural anesthesia (TEA). However, the magnitude (B) of DOR increase was attenuated after TEA versus in pre-TEA conditions. \*All  $P < 0.009$  versus baseline (BL), # $P = 0.029$  versus pre-TEA.  $n = 8$ .

Our results describing TEA's effects on baseline electrophysiology contrast previous canine studies that report prolongation of regional monophasic action potential (MAP).<sup>14,42</sup> Meissner *et al.*<sup>14</sup> reported an increase in the duration of regional MAP<sub>90%</sub> in the right ventricular endocardium when using paced ventricular beats at 200 to 400 ms cycle length (heart rate 150 to 300 beats/min) as baseline rhythm. However, since fast ventricular pacing itself leads to increased cardiac sympathetic nerve activity in the myocardium,<sup>43</sup> it is likely that TEA largely mitigated the reduction in MAP caused by pacing-induced sympathetic activity in their study.<sup>14</sup> In anesthetized canine models in the study by Hotvedt *et al.*,<sup>42</sup> the animals also

had baseline tachycardia (heart rate greater than 110 beats/min) due to high sympathetic tone before induction of TEA, explaining the effects of TEA on resting MAPs. This further supports our results that ventricular electrophysiology is not affected by TEA during resting conditions, but only during increased sympathoexcitation. Although baseline model condition and recording techniques likely explain the observed differences between our results, it is conceivable that effects of TEA on baseline APD are more marked in the canine model compared to the porcine model due to differences in drug dosage/effect, sympathetic innervation, and/or electrophysiologic properties of the myocardium in different species.

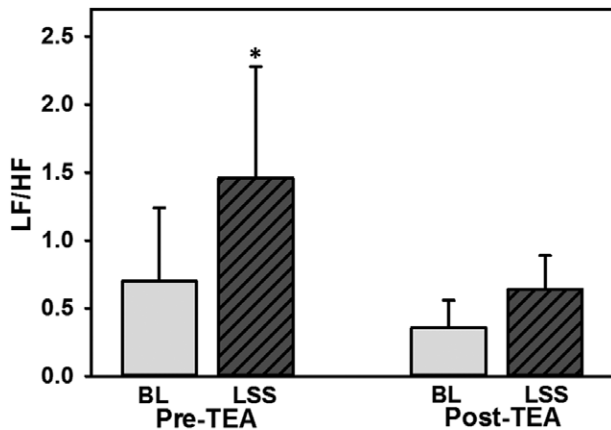

**Fig. 8.** Heart rate variability (HRV) response to left stellate stimulation (LSS) with and without thoracic epidural anesthesia (TEA). LSS increases low-frequency (LF)/high-frequency (HF) in the pre-TEA condition but not after treatment with TEA. \* $P = 0.043$  versus pre-TEA baseline (BL),  $P = 0.003$  versus post-TEA baseline, and  $P = 0.030$  versus LSS post-TEA,  $n = 8$ . LF/HF = ratio of LF to HF components of HRV.

### TEA Enhances Ventricular Electrical Wave Stability: APD Restitution

We observed that TEA flattens the slope of the restitution curve, especially at short cycle length intervals typically relevant during tachyarrhythmias, indicating that sympathetic blockade with TEA creates a myocardial substrate with enhanced electrical wave stability less predisposed to arrhythmogenesis. Similar to the effects seen with TEA, antiarrhythmic medications that reduce the slope of the restitution curve decrease ventricular fibrillation (VF) inducibility and are important therapies.<sup>21,44</sup> Conversely, increase in APD restitution slope has been shown in clinical studies using adrenergic agonists isoprenaline or adrenaline that created ventricular tachyarrhythmia.<sup>45</sup> The APD restitution describes the physiologic relationship of APD at different heart rates, whereby a shortening of the diastolic interval at progressively faster heart rates leads to a shortening of the following APD.<sup>21,38,39</sup> As the slope of the APD restitution curve increases, APD can be severely reduced leading to conduction wave breaks. Thus, the onset of VF occurs when spiral conduction waves break and degrade into multiple wavelets.<sup>21,38</sup>

Neuromodulation with enhanced sympathetic stimulation from the spinal cord has been shown in previous elegant studies to increase APD restitution slope and decrease VF thresholds in an autonomically intact langendorff perfused rabbit heart.<sup>38,46</sup>

In our study, TEA reduced sympathetic output and decreased the slope of the APD restitution curve, providing a therapeutic benefit for ventricular tachyarrhythmias. We performed a comprehensive assessment of activation recovery interval (APD) and diastolic interval relationship at cycle lengths less than 100 ms (heart rate greater than 600 beats/min) that are typically seen and relevant during fast ventricular tachyarrhythmia/VF. Similar to our findings, Meissner *et al.*<sup>14</sup> reported in a canine right ventricle model paced at longer

cycle lengths of 200 to 400 ms (heart rate, 150 to 300 beats/min) that TEA prolongs ERP, suggesting an antiarrhythmic effect of TEA on the myocardial electrophysiology. At a cellular level, APD restitution is determined by the kinetics of various ionic currents, specifically reactivation of L-type  $\text{Ca}^{2+}$  current ( $i_{\text{Ca,L}}$ ), recovery of the  $\text{Ca}^{2+}$  transient, and thus inward  $\text{Na}^{+}$ – $\text{Ca}^{2+}$  exchange current ( $i_{\text{NaCa}}$ ) and deactivation of rapid and slow delayed-rectifier  $\text{K}^{+}$  currents ( $i_{\text{K,r}}$  and  $i_{\text{K,s}}$ ).<sup>39,47,48</sup> TEA, by directly reducing sympathetic output from the spinal cord, delays the above ionic processes and flattens APD restitution.

### TEA Attenuates Sympathoexcitation and Decreases Ventricular Arrhythmogenesis during Sympathetic Stimulation

We demonstrated that TEA suppresses ventricular myocardial excitability during the sympathetic hyperactivity observed with LSS. We and others have previously shown in a porcine model that LSS effectively produces a model of sympathetically driven ventricular tachyarrhythmias in both normal and ischemic hearts.<sup>26,47,49–51</sup> Excess sympathetic activity leading to ventricular tachyarrhythmias is commonly seen in clinical conditions associated with myocardial ischemia/infarction, ventricular electrical storm, catecholaminergic polymorphic ventricular tachycardia, and other sympathetically mediated ventricular tachyarrhythmias. The principal mechanism underlying the majority of these clinically observed ventricular tachyarrhythmias is reentry involving a complex interaction between activation and repolarization of electrical wave fronts.<sup>39,52–54</sup> Increased sympathetic output causes heterogeneous shortening of activation recovery interval and repolarization time in the ventricles—this worsening of dispersion of repolarization in the ventricular myocardium creates a substrate for initiation and maintenance of reentry. In this study, TEA was found to reduce myocardial sympathoexcitation and dispersion of refractoriness as well as stabilize electrical wave restitution, thus demonstrating that TEA is able to mitigate the most common causes of ventricular tachyarrhythmias. Further, our results also show that TEA attenuated heart rate variability LF/HF and repolarization time, signifying a reduction in sympathoexcitation and myocardial excitability. The effect of TEA on activation recovery interval (local APD) was primarily as a result of its direct effect on repolarization time shortening; the activation time remained unchanged during sympathetic stimulation.

Neural modulation techniques including TEA, spinal cord stimulation, left stellate ganglion block, or sympathectomy mitigate sympathetic responses and have been shown to be clinically beneficial in treating these ventricular tachyarrhythmias.<sup>5,13,16,17,20</sup> TEA reduced refractory malignant ventricular tachyarrhythmias in patients with structural heart disease.<sup>5</sup> Structural heart disease predisposes patients to reentry at the border zone of normal and abnormal myocardium, and this risk is also enhanced in the perioperative period due to sympathetic hyperactivity. Therefore, our results demonstrating both decreased



APD shortening and dispersion of repolarization during sympathoexcitatory states lend mechanistic insight into the clinical therapeutic benefit of TEA.

### Limitations

We used healthy animals to study the mechanistic effects of TEA on myocardial electrophysiology. However, autonomic tone at baseline and cardiac function in healthy animals may be different from that with structural heart disease. Species-specific differences can be seen between animal models. We have chosen the porcine model because the cardiac electrophysiologic parameters have been extensively studied, thus providing an excellent large animal translational model for studying myocardial sympathoexcitation and arrhythmogenesis.<sup>26,28,29</sup> Epidural catheter placement and distribution of local anesthetics were not evaluated using fluoroscopic guidance. However, blue dye was added to the bupivacaine injection, and a laminectomy was done at the end of each experiment to confirm the exact location of the catheter and to ascertain the spread of local anesthetic. Experimental protocols were performed pre- and post-TEA in order to decrease interanimal variability and examine the before and after effect of TEA on cardiac electrophysiology. Our cardiac mapping involved recording only epicardial electrograms; therefore, the effect of TEA on endocardial electrophysiology can be only inferred by our current methods. However, previous studies have found no difference in left ventricular epicardial *versus* endocardial activation recovery interval or dispersion of repolarization with sympathetic stimulation.<sup>28</sup>

### Conclusion

Our comprehensive assessment of the effects of TEA on ventricular electrophysiology shows that TEA is effective in attenuating ventricular excitability and mitigating the proarrhythmic effects of sympathetic hyperactivity in the porcine heart. Myocardial excitability was suppressed during sympathetic hyperactivity with no significant change observed in the baseline state. Our findings provide insights into the electrophysiologic mechanisms underlying the antiarrhythmic effects of TEA and provide evidence supporting the treatment of ventricular arrhythmias by TEA.

### Research Support

Support for this study was provided solely from institutional and/or departmental sources. Supported by Research Project Grant (R01) HL084261 from the National Heart, Lung, and Blood Institute, National Institute of Health, Bethesda, Maryland (to Dr. Mahajan). Supported by the Foundation for Education and Research, Schaumburg, Illinois, and Society of Cardiovascular Anesthesiologists-International Anesthesia Research Society Starter Grant, San Francisco, California (to Dr. Howard-Quijano).

### Competing Interests

The authors declare no competing interests.

### Correspondence

Address correspondence to Dr. Mahajan: Department of Anesthesiology and Perioperative Medicine, David Geffen School of Medicine at UCLA, 757 Westwood Blvd., Suite 3325, Los Angeles, California 90095. amahajan@mednet.ucla.edu. Information on purchasing reprints may be found at [www.anesthesiology.org](http://www.anesthesiology.org) or on the masthead page at the beginning of this issue. ANESTHESIOLOGY's articles are made freely accessible to all readers, for personal use only, 6 months from the cover date of the issue.

### References

1. Shen MJ, Zipes DP: Role of the autonomic nervous system in modulating cardiac arrhythmias. *Circ Res* 2014; 114:1004–21
2. Vaseghi M, Shivkumar K: The role of the autonomic nervous system in sudden cardiac death. *Prog Cardiovasc Dis* 2008; 50:404–19
3. Armour JA: Cardiac neuronal hierarchy in health and disease. *Am J Physiol Regul Integr Comp Physiol* 2004; 287:R262–71
4. Armour JA: Functional anatomy of intrathoracic neurons innervating the atria and ventricles. *Heart Rhythm* 2010; 7:994–6
5. Bourke T, Vaseghi M, Michowitz Y, Sankhla V, Shah M, Swapna N, Boyle NG, Mahajan A, Narasimhan C, Lokhandwala Y, Shivkumar K: Neuraxial modulation for refractory ventricular arrhythmias: Value of thoracic epidural anesthesia and surgical left cardiac sympathetic denervation. *Circulation* 2010; 121:2255–62
6. Vaseghi M, Gima J, Kanaan C, Ajjola OA, Marmureanu A, Mahajan A, Shivkumar K: Cardiac sympathetic denervation in patients with refractory ventricular arrhythmias or electrical storm: Intermediate and long-term follow-up. *Heart Rhythm* 2014; 11:360–6
7. Bromage PR: Mechanism of action of extradural analgesia. *Br J Anaesth* 1975; 47 suppl:199–211
8. Boswell MV, Iacono RP, Guthkelch AN: Sites of action of subarachnoid lidocaine and tetracaine: Observations with evoked potential monitoring during spinal cord stimulator implantation. *Reg Anesth* 1992; 17:37–42
9. Freise H, Meissner A, Lauer S, Ellger B, Radke R, Bruewer M, Brodner G, Van Aken HK, Sielenkämper AW, Fischer LG: Thoracic epidural analgesia with low concentration of bupivacaine induces thoracic and lumbar sympathetic block: A randomized, double-blind clinical trial. *ANESTHESIOLOGY* 2008; 109:1107–12
10. Loick HM, Schmidt C, Van Aken H, Junker R, Erren M, Berendes E, Rolf N, Meissner A, Schmid C, Scheld HH, Möllhoff T: High thoracic epidural anesthesia, but not clonidine, attenuates the perioperative stress response via sympatholysis and reduces the release of troponin T in patients undergoing coronary artery bypass grafting. *Anesth Analg* 1999; 88:701–9
11. Rajakaruna C, Rogers C, Pike K, Alwair H, Cohen A, Tomkins S, Angelini GD, Caputo M: Superior haemodynamic stability during off-pump coronary surgery with thoracic epidural anaesthesia: Results from a prospective randomized controlled trial. *Interact Cardiovasc Thorac Surg* 2013; 16:602–7
12. Schmidt C, Hinder F, Van Aken H, Theilmeier G, Bruch C, Wirtz SP, Bürkle H, Gühs T, Rothenburger M, Berendes E: The effect of high thoracic epidural anesthesia on systolic and diastolic left ventricular function in patients with coronary artery disease. *Anesth Analg* 2005; 100:1561–9
13. Blomberg S, Ricksten SE: Thoracic epidural anaesthesia decreases the incidence of ventricular arrhythmias during acute myocardial ischaemia in the anaesthetized rat. *Acta Anaesthesiol Scand* 1988; 32:173–8
14. Meissner A, Eckardt L, Kirchhof P, Weber T, Rolf N, Breithardt G, Van Aken H, Haverkamp W: Effects of thoracic epidural

- anesthesia with and without autonomic nervous system blockade on cardiac monophasic action potentials and effective refractoriness in awake dogs. *ANESTHESIOLOGY* 2001; 95:132–8; discussion 6A
15. Yang SS, Han W, Cao Y, Dong G, Zhou G, Li WM, Gan RT, Chang HY, Wang Z: Effects of high thoracic epidural anesthesia on atrial electrophysiological characteristics and sympathetic nerve sprouting in a canine model of atrial fibrillation. *Basic Res Cardiol* 2011; 106:495–506
  16. Mahajan A, Moore J, Cesario DA, Shivkumar K: Use of thoracic epidural anesthesia for management of electrical storm: A case report. *Heart Rhythm* 2005; 2:1359–62
  17. Groban L, Zvara DA, Deal DD, Vernon JC, Carpenter RL: Thoracic epidural anesthesia reduces infarct size in a canine model of myocardial ischemia and reperfusion injury. *J Cardiothorac Vasc Anesth* 1999; 13:579–85
  18. Blomberg S, Emanuelsson H, Kvist H, Lamm C, Pontén J, Waagstein F, Ricksten SE: Effects of thoracic epidural anesthesia on coronary arteries and arterioles in patients with coronary artery disease. *ANESTHESIOLOGY* 1990; 73:840–7
  19. Klassen GA, Bramwell RS, Bromage PR, Zborowska-Sluis DT: Effect of acute sympathectomy by epidural anesthesia on the canine coronary circulation. *ANESTHESIOLOGY* 1980; 52:8–15
  20. Kamibayashi T, Hayashi Y, Mammoto T, Yamatodani A, Taenaka N, Yoshiya I: Thoracic epidural anesthesia attenuates halothane-induced myocardial sensitization to dysrhythmogenic effect of epinephrine in dogs. *ANESTHESIOLOGY* 1995; 82:129–34
  21. Cao JM, Qu Z, Kim YH, Wu TJ, Garfinkel A, Weiss JN, Karagueuzian HS, Chen PS: Spatiotemporal heterogeneity in the induction of ventricular fibrillation by rapid pacing: Importance of cardiac restitution properties. *Circ Res* 1999; 84:1318–31
  22. Dreifus LS AJ, Botvinick EH, Ferdinand KC, Fisch C, Fisher JD, Kennedy JW, Kerber RE, Lambert CR, Okike ON, Prystowsky EN, Saksena SV, Schroeder JS, Williams DO: Heart rate variability for risk stratification of life-threatening arrhythmias. American College of Cardiology Cardiovascular Technology Assessment Committee. *J Am Coll Cardiol* 1993; 22:948–50
  23. Haws CW, Lux RL: Correlation between *in vivo* transmembrane action potential durations and activation-recovery intervals from electrograms. Effects of interventions that alter repolarization time. *Circulation* 1990; 81:281–8
  24. Opthof T, Janse MJ, Meijborg VM, Cinca J, Rosen MR, Coronel R: Dispersion in ventricular repolarization in the human, canine and porcine heart. *Prog Biophys Mol Biol* 2016; 120:222–35
  25. Opthof T, Sutton P, Coronel R, Wright S, Kallis P, Taggart P: The Association of Abnormal Ventricular Wall Motion and Increased Dispersion of Repolarization in Humans is Independent of the Presence of Myocardial Infarction. *Front Physiol* 2012; 3:235
  26. Vaseghi M, Yamakawa K, Sinha A, So EL, Zhou W, Ajjola OA, Lux RL, Laks M, Shivkumar K, Mahajan A: Modulation of regional dispersion of repolarization and T-peak to T-end interval by the right and left stellate ganglia. *Am J Physiol Heart Circ Physiol* 2013; 305:H1020–30
  27. Vaseghi M, Zhou W, Shi J, Ajjola OA, Hadaya J, Shivkumar K, Mahajan A: Sympathetic innervation of the anterior left ventricular wall by the right and left stellate ganglia. *Heart Rhythm* 2012; 9:1303–9
  28. Yagishita D, Chui RW, Yamakawa K, Rajendran PS, Ajjola OA, Nakamura K, So EL, Mahajan A, Shivkumar K, Vaseghi M: Sympathetic nerve stimulation, not circulating norepinephrine, modulates T-peak to T-end interval by increasing global dispersion of repolarization. *Circ Arrhythm Electrophysiol* 2015; 8:174–85
  29. Rajendran PS NK, Ajjola OA, Vaseghi M, Armour JA, Ardell JL, Shivkumar K: Myocardial infarction induces structural and functional remodeling of the intrinsic cardiac nervous system. *J Physiol*. 2016; 594:321–41
  30. Magee DA, Sweet PT, Holland AJ: Epidural anaesthesia with mixtures of bupivacaine and lidocaine. *Can Anaesth Soc J* 1983; 30:174–8
  31. Ahlberg SE, Yue AM, Skadsberg ND, Roberts PR, Iaizzo PA, Morgan JM: Investigation of pacing site-related changes in global restitution dynamics by non-contact mapping. *Europace* 2008; 10:40–5
  32. Chinushi M, Tagawa M, Kasai H, Washizuka T, Abe A, Furushima H, Aizawa Y: Correlation between the effective refractory period and activation-recovery interval calculated from the intracardiac unipolar electrogram of humans with and without dl-sotalol treatment. *Jpn Circ J* 2001; 65:702–6
  33. Kammerling JJ, Green FJ, Watanabe AM, Inoue H, Barber MJ, Henry DP, Zipes DP: Denervation supersensitivity of refractoriness in noninfarcted areas apical to transmural myocardial infarction. *Circulation* 1987; 76:383–93
  34. Millar CK, Kralios FA, Lux RL: Correlation between refractory periods and activation-recovery intervals from electrograms: Effects of rate and adrenergic interventions. *Circulation* 1985; 72:1372–9
  35. Xiong W, Tian Y, DiSilvestre D, Tomaselli GF: Transmural heterogeneity of Na<sup>+</sup>-Ca<sup>2+</sup> exchange: Evidence for differential expression in normal and failing hearts. *Circ Res* 2005; 97:207–9
  36. Yue AM, Paisey JR, Robinson S, Betts TR, Roberts PR, Morgan JM: Determination of human ventricular repolarization by noncontact mapping: Validation with monophasic action potential recordings. *Circulation* 2004; 110:1343–50
  37. Ajjola OA, Vaseghi M, Zhou W, Yamakawa K, Benharash P, Hadaya J, Lux RL, Mahajan A, Shivkumar K: Functional differences between junctional and extrajunctional adrenergic receptor activation in mammalian ventricle. *Am J Physiol Heart Circ Physiol* 2013; 304:H579–88
  38. Ng GA, Brack KE, Patel VH, Coote JH: Autonomic modulation of electrical restitution, alternans and ventricular fibrillation initiation in the isolated heart. *Cardiovasc Res* 2007; 73:750–60
  39. Qu Z, Weiss JN, Garfinkel A: Cardiac electrical restitution properties and stability of reentrant spiral waves: A simulation study. *Am J Physiol* 1999; 276(1 Pt 2):H269–83
  40. Heart rate variability: Standards of measurement, physiological interpretation, and clinical use. Task Force of the European Society of Cardiology and the North American Society of Pacing and Electrophysiology. *Circulation* 1996; 93:1043–65
  41. Janse MJ, Wit AL: Electrophysiological mechanisms of ventricular arrhythmias resulting from myocardial ischemia and infarction. *Physiol Rev* 1989; 69:1049–169
  42. Hotvedt R, Platou ES, Refsum H: Electrophysiological effects of thoracic epidural analgesia in the dog heart in situ. *Cardiovasc Res* 1983; 17:259–66
  43. Ardell JL, Cardinal R, Vermeulen M, Armour JA: Dorsal spinal cord stimulation obtunds the capacity of intrathoracic extracardiac neurons to transduce myocardial ischemia. *Am J Physiol Regul Integr Comp Physiol* 2009; 297:R470–7
  44. Garfinkel A, Kim YH, Voroshilovsky O, Qu Z, Kil JR, Lee MH, Karagueuzian HS, Weiss JN, Chen PS: Preventing ventricular fibrillation by flattening cardiac restitution. *Proc Natl Acad Sci USA* 2000; 97:6061–6
  45. Taggart P, Sutton P, Chalabi Z, Boyett MR, Simon R, Elliott D, Gill JS: Effect of adrenergic stimulation on action potential duration restitution in humans. *Circulation* 2003; 107:285–9
  46. Ng GA, Mantravadi R, Walker WH, Ortin WG, Choi BR, de Groat W, Salama G: Sympathetic nerve stimulation produces spatial heterogeneities of action potential restitution. *Heart Rhythm* 2009; 6:696–706
  47. Taggart P, Sutton P, Chalabi Z, Boyett MR, Simon R, Elliott D, Gill JS: Effect of adrenergic stimulation on action potential duration restitution in humans. *Circulation* 2003; 107:285–89

48. Volders PG, Stengl M, van Opstal JM, Gerlach U, Spätjens RL, Beekman JD, Sipido KR, Vos MA: Probing the contribution of IKs to canine ventricular repolarization: Key role for beta-adrenergic receptor stimulation. *Circulation* 2003; 107:2753–60
49. Cardinal R, Savard P, Armour JA, Nadeau R, Carson DL, LeBlanc AR: Mapping of ventricular tachycardia induced by thoracic neural stimulation in dogs. *Can J Physiol Pharmacol* 1986; 4:411–18
50. Coronel R, Wilms-Schopman FJ, Opthof T, Janse MJ: Dispersion of repolarization and arrhythmogenesis. *Heart Rhythm* 2009; 6:537–43
51. Janse MJ, Schwartz PJ, Wilms-Schopman F, Peters RJ, Durrer D: Effects of unilateral stellate ganglion stimulation and ablation on electrophysiologic changes induced by acute myocardial ischemia in dogs. *Circulation* 1985; 72:585–95
52. Goldhaber JI, Xie LH, Duong T, Motter C, Khuu K, Weiss JN: Action potential duration restitution and alternans in rabbit ventricular myocytes: The key role of intracellular calcium cycling. *Circ Res* 2005; 4:459–66
53. Ben-David J, Zipes DP: Differential response to right and left ansae subclaviae stimulation of early afterdepolarizations and ventricular tachycardia induced by cesium in dogs. *Circulation* 1988; 78:1241–50
54. Opthof T, Coronel R, Vermeulen JT, Verberne HJ, van Capelle FJ, Janse MJ: Dispersion of refractoriness in normal and ischaemic canine ventricle: Effects of sympathetic stimulation. *Cardiovasc Res* 1993; 27:1954–60

## ANESTHESIOLOGY REFLECTIONS FROM THE WOOD LIBRARY-MUSEUM

### Kadavy's "Kan Klamp": Alliteration and Economy from an "Ether-can Attachment Dropper"

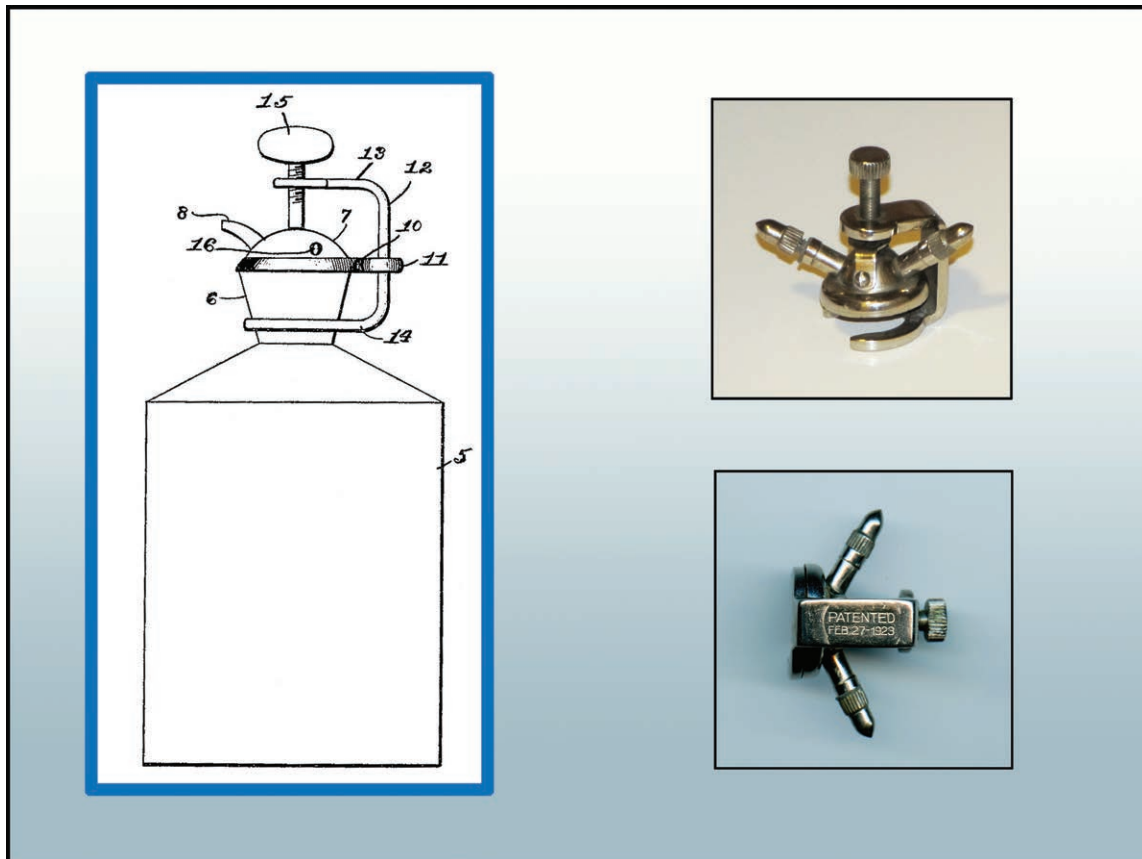

From Ravenna, Nebraska, on March 21, 1922, Godfrey Joseph Kadavy, M.D. (1889 to 1972), filed his "Ether-can attachment dropper" drawing (left) with the U.S. Patent Office. According to Kadavy's filing, he designed this invention as: (1) "a novel form of closure to be secured to the discharge opening of a can for dispensing the contents [ether] of the can by drops" and (2) a "means for securing the auxiliary closure to the can top to insure a fluid-tight connection between the mouth of the can and closure." On February 27, 1923, this self-described "Bohemian-American Cornhusker" was granted U.S. Patent 1446751. His patent design (left) was mass-produced as the "Kan Klamp" (upper right). On the back of the C-arm of each "Klamp" is stamped the date on which the patent was granted: "PATENTED / FEB. 27 - 1923" (lower right). This was merely the first of at least five U.S. patents that inventor-physician Kadavy would be granted between 1923 and 1958. (Copyright © the American Society of Anesthesiologists' Wood Library-Museum of Anesthesiology.)

George S. Bause, M.D., M.P.H., Honorary Curator and Laureate of the History of Anesthesia, Wood Library-Museum of Anesthesiology, Schaumburg, Illinois, and Clinical Associate Professor, Case Western Reserve University, Cleveland, Ohio. UJYC@aol.com.