

Investigation of a parameter estimation method for contaminant transport in aquifers

Channa Rajanayaka and Don Kulasiri

ABSTRACT

Real world groundwater aquifers are heterogeneous and system variables are not uniformly distributed across the aquifer. Therefore, in the modelling of the contaminant transport, we need to consider the uncertainty associated with the system. Unny presented a method to describe the system by stochastic differential equations and then to estimate the parameters by using the maximum likelihood approach. In this paper, this method was explored by using artificial and experimental data. First a set of data was used to explore the effect of system noise on estimated parameters. The experimental data was used to compare the estimated parameters with the calibrated results. Estimates obtained from artificial data show reasonable accuracy when the system noise is present. The accuracy of the estimates has an inverse relationship to the noise. Hydraulic conductivity estimates in a one-parameter situation give more accurate results than in a two-parameter situation. The effect of the noise on estimates of the longitudinal dispersion coefficient is less compared to the effect on hydraulic conductivity estimates. Comparison of the results of the experimental dataset shows that estimates of the longitudinal dispersion coefficient are similar to the aquifer calibrated results. However, hydraulic conductivity does not provide a similar level of accuracy. The main advantage of the estimation method presented here is its direct dependence on field observations in the presence of reasonably large noise levels.

Key words | groundwater, solute transport, hydrologic parameters, system noise, parameter estimation

Channa Rajanayaka (corresponding author)
Don Kulasiri
Applied Computing,
Mathematics and Statistics Group,
Division of Applied Management and Computing,
PO Box 84,
Lincoln University,
Canterbury,
New Zealand

INTRODUCTION

The estimation of parameters of groundwater systems such as hydraulic conductivity and hydrodynamic dispersion coefficients, using inverse methods, has been an active research area in hydrology and hydraulics studies over the past few decades. Generally accepted methods for the estimation of parameters, such as pumping tests and permeameter tests (literature on these tests can be found in Bear *et al.* (1968) and Bear (1979)), are either performed on limited areas of the experimental site or are based on laboratory tests on a few soil samples. These methods are applied mainly based on several assumptions: homogeneity of the groundwater system in a large region around the point of testing, uniform inputs, and uniform flow velocity. The high monetary requirements limit the

implementation of field tests over the entire experimental area. Freeze (1972) showed that the experimental values reflect the parameters only at the point measured and cannot be considered as a representation of the whole region considered. The heterogeneous formation of porous structure, irregular boundaries, random inputs (e.g. rainfall) and random boundary effects of aquifers introduce random effects into the system. Further, even though the laboratory tests are carried out very carefully, they can be subject to as much randomness as that in the field measured data (Unny 1989). Due to such randomness in the system it is not accurate to base only on the direct linear relationships and deterministic considerations without considering the noise in the system. Hence, it is

important to use a theoretically valid procedure for the estimation of aquifer hydrologic parameters in the presence of noise based on the field observed data.

Kitanidis & Vomvoris (1983) proposed a methodology for estimating hydrologic parameters in the presence of uncertainty. This method offers acceptable results in many cases and is based on a geostatistical approach. The methodology estimates the hydrologic parameters from head and discharge measurements. The main advantage of this method is that it avoids the problem of large dimensionality. The large dimensionality problem arises with almost all previously recognised parameter estimation methods due to the necessity of state and parameter vectors which contain hundreds of variables to describe the groundwater system. Those large numbers of parameters need to be estimated independently. However, due to the stochastic nature of the system, the accuracy of the estimated independent parameters is subject to randomness. Hence, representation of the groundwater system is adversely affected by the combination of such inaccurate independently estimated parameters. The method of Kitanidis & Vomvoris (1983) drastically reduces the number of independent effective parameters to be estimated and therefore increases the accuracy. However, Dietrich & Newsam (1989) showed that the methods such as described in Kitanidis & Vomvoris (1983) which use finite difference representation may lead to the problem of instability. Other prominent geostatistical approaches in the estimation of subsurface parameters are the inverse method for transient flow developed by Sun & Yeh (1992), the fast Fourier transform method developed by Gutjahr & Wilson (1989), the linearised semianalytical method developed by Dagan (1985), the fractal simulation method developed by Grindrod & Impey (1991), the pilot point method developed by RamaRao *et al.* (1995), the maximum likelihood method developed by Carrera & Neuman (1986a, b) and the sequential self-calibration method developed by Sahuquillo *et al.* (1992).

The several reviews and comparisons of inverse methods were conducted over the past two decades to investigate and identify the precision and robustness of each method. Yew (1986) carried out a review of parameter identification procedures in groundwater hydrology. Another comparison of several inverse

methods was conducted by Kuiper (1986). In 1991 Keidser & Rosbjerg (1991) investigated four inverse methods and compared them for four test problems. McLaughlin & Townley (1996) conducted a reassessment of groundwater inverse problems. However, a team of 22 researchers got together and conducted a major comparison of prominent geostatistical inverse methods (Zimmerman *et al.* 1998). These reviews show that, in practice, it may be difficult to identify the most appropriate inverse method for a given problem, as different type of heterogeneity may be prominent for the system of interest. It is apparent that researchers in this area are not clear how to select the most suitable method for a given problem. The above-mentioned reviews confirmed that some methods perform better for a given type of heterogeneity, while they would perform less well for another.

Unny (1989) presented a stochastic approach for the estimation of parameters of a groundwater system. He pointed out that the normal practice in environmental studies of solving the problem by using linear partial differential equations which describe the behaviour of groundwater systems is not accurate because of the above mentioned randomness induced into the aquifers. The problem can be represented by a stochastic partial differential equation where stochasticity was introduced as a noise term. Then the parameters are estimated from the observed values of the dependent variable of the stochastic partial differential equation by using the maximum likelihood approach, which systematically searches over different possible parameter values, finally selecting parameter estimates that are most likely (have the 'maximum likelihood') to be true, given the set of observations. The advantage of this method is that the field measurements can be directly used to compute the dependent variables and their derivatives, and to then evaluate parameters.

In this paper we briefly describe the stochastic inverse methodology of estimating parameters (Unny 1989) from observed values. Then, we investigate this method by using one-parameter and two-parameter governing equations that describe the advective and dispersive transport of solutes in a saturated porous medium in one dimension. The following one-dimensional stochastic advective transport Equation (1) was used to describe the system in the one-parameter, K , estimation study:

$$\frac{\partial C}{\partial t} = -v_x \left(\frac{\partial C}{\partial x} \right) + \xi(x,t) \quad (1)$$

where

$$v_x = \frac{K}{n_e} \left(\frac{dh}{dl} \right). \quad (2)$$

Then, we use the one-dimensional stochastic advection-dispersion Equation (3) to represent the porous media to estimate the two parameters involved, K and D_L :

$$\frac{\partial C}{\partial t} = D_L \left(\frac{\partial^2 C}{\partial x^2} \right) - v_x \left(\frac{\partial C}{\partial x} \right) + \xi(x,t). \quad (3)$$

Then, we explore the significance of system noise on estimated parameters by using Equations (1) and (3). Further, we extend the investigation to an experimental comparison of the parameter estimates by using a simulation-based contaminant transport experiment.

PARAMETER ESTIMATION PROCEDURE

It is a common practice to describe the hydraulic and hydrology problems in the form of linear time dependent partial differential equations. It is always necessary to make assumptions to describe the system in deterministic form. That is, we assume that system variables are uniformly distributed throughout the system, or in other words, assume that the aquifer is homogeneous. As an example, when dissolved solids are transported by advection in a groundwater aquifer, such flow can be described by a one-dimensional advective transport equation, when flow is normal to a unit cross-sectional area, as follows:

$$\frac{\partial C}{\partial t} = -v_x \frac{\partial C}{\partial x}. \quad (4)$$

This is the deterministic form of the equation and to account for the randomness within the system, we add a noise term to Equation (4) and describe the stochastic one-dimensional advective transport equation as given in Equation (1):

$$\frac{\partial C}{\partial t} = -v_x \left(\frac{\partial C}{\partial x} \right) + \xi(x,t) \quad (5)$$

where $\xi(x,t)$ is described by a zero-mean stochastic process.

We multiply Equation (5) by dt throughout and formally replace $\xi(x,t)dt$ by $d\beta(t)$, where $d\beta(t)$ is a Hilbert space¹ valued Wiener incremental process. Now, we can obtain the stochastic partial differential equation as follows:

$$\partial C = -v_x \left(\frac{\partial C}{\partial x} \right) dt + d\beta(t). \quad (6)$$

The explanation of the transformation of $\xi(x,t)dt$ to $d\beta(t)$ can be found in Jazwinski (1970).

When we substitute Equation (2) in Equation (6), we obtain

$$\partial C = -\frac{K}{n_e} \left(\frac{dh}{dl} \right) \left(\frac{\partial C}{\partial x} \right) dt + d\beta(t). \quad (7)$$

In this paper we use this stochastic advective transport Equation (7) as the governing equation to estimate the unknown parameter K in one-parameter case, given a set of measured concentration values.

For the two-parameter estimation, we use a one-dimensional advective-dispersive equation. In a homogeneous medium with a uniform velocity field, flow parallel to the x axis and subjected to both advection and dispersion can be described by

$$\frac{\partial C}{\partial t} = D_L \left(\frac{\partial^2 C}{\partial x^2} \right) - v_x \left(\frac{\partial C}{\partial x} \right). \quad (8)$$

As we explained in the one-parameter case, when randomness enters into the system, the stochastic advection-dispersion equation is given by

$$\frac{\partial C}{\partial t} = D_L \left(\frac{\partial^2 C}{\partial x^2} \right) - v_x \left(\frac{\partial C}{\partial x} \right) + \xi(x,t). \quad (9)$$

¹A Hilbert space is an inner space which is a complete metric space with respect to the metric induced by its inner product, and a separable Hilbert space should contain a complete orthonormal sequence (Young 1988).

When Equation (9) is multiplied by dt throughout and $\xi(x,t)dt$ is formally replaced by $d\beta(t)$ and values for v_x are substituted from equation (2), then

$$\partial C = D_L \left(\frac{\partial^2 C}{\partial x^2} \right) dt - \frac{K}{n_e} \left(\frac{dh}{dl} \right) \left(\frac{\partial C}{\partial x} \right) dt + d\beta(t). \tag{10}$$

We use equation (10) as the governing equation to estimate the two unknown parameters D_L and K .

The theoretical basis of the parameter estimation method that we use in this paper has been given by Unny (1989) and will not be repeated here (see also Lipster & Shirayev (1977), Basawa *et al.* (1980) and Kutoyants (1984)). Suppose we have the observations of solute concentration, C_i at M independent space coordinates along the x axis, where $1 \leq i \leq M$, at different time intervals, t (where $0 \leq t \leq T$). That is we have M numbers of C_i observations for each time step. Hence, altogether, there are $((T + 1)M)$ numbers of C_i observations. We use these observations to estimate the parameter θ , which may be K and/or D_L , of all possible parameter values using the maximum likelihood approach.

First, we can write the deterministic component of the above governing equations (Equations (4) or (8)) in the form of

$$dC_i(t, \theta) = S(t, C_i, \theta) dt. \tag{11}$$

As we explained above, we can add a noise, $d\beta(t)$, into equation (11) to represent the system randomness and it can be written as

$$dC_i(t, \theta) = S(t, C_i, \theta) dt + d\beta(t). \tag{12}$$

Since we describe the noise of the system by a separate term, $d\beta(t)$, we can assume that $S(t, C_i, \theta)dt$ depends linearly on the parameters θ . When there is only one parameter (say θ_1) in the governing equation (4), it can represent the $S(t, C, \theta)dt$ part in equation (12) as

$$S(t, C_i, \theta) dt = a_0(C_i, t) + \theta_1 a_1(C_i, t). \tag{13}$$

Equation (13) is similar to equation (4). Hence

$$a_0(C_i, t) = 0; \quad a_1(C_i, t) = \left(\frac{\partial C}{\partial x} \right)_i; \quad \theta_1 = v_x.$$

The parameter estimate is given by (Unny 1989)

$$\theta_1 = \frac{\sum_{i=1}^M \int_0^T \{a_1(C_i, t)\} dC_i(t) - \sum_{i=1}^M \int_0^T \{a_0(C_i, t)\} \{a_1(C_i, t)\} dt}{\sum_{i=1}^M \int_0^T \{a_1^2(C_i, t)\} dt}. \tag{14}$$

When we substitute the above values for $a_0(C_i, t)$, $a_1(C_i, t)$ and θ_1 we obtain the estimated parameter:

$$v_x = \frac{\sum_{i=1}^M \int_0^T \left(\frac{\partial C}{\partial x} \right)_i dC_i(t)}{\sum_{i=1}^M \int_0^T \left\{ \left(\frac{\partial C}{\partial x} \right)_i \right\}^2 dt}. \tag{15}$$

The value for v_x can be found by using the following summations:

$$v_x = \frac{\sum_{i=1}^M \sum_{t=0}^T \left(\frac{\partial C}{\partial x} \right)_i \Delta C_i}{\sum_{i=1}^M \sum_{t=0}^T \left\{ \left(\frac{\partial C}{\partial x} \right)_i \right\}^2 \Delta t}. \tag{16}$$

Now, we can calculate the unknown parameter K by using equation (2) for a given pressure gradient.

Then, in the two-parameter case (say, θ_1 and θ_2) it can be written as

$$S(t, C_i, \theta) = a_0(C_i, t) + \theta_1 a_1(C_i, t) + \theta_2 a_2(C_i, t). \tag{17}$$

Since equation (17) and equation (8) are similar

$$a_0(C_i, t) = 0; \quad a_1(C_i, t) = \left(\frac{\partial^2 C}{\partial x^2} \right)_i; \quad a_2(C_i, t) = \left(\frac{\partial C}{\partial x} \right)_i;$$

$$\theta_1 = D_L; \quad \theta_2 = v_x.$$

We can obtain the estimated parameter values for θ_1 and θ_2 as solutions to these two simultaneous equations (see Unny 1989):

$$\begin{aligned} \sum_{i=1}^M \int_0^T \{a_1(C_i, t)\} dC_i(t) - \sum_{i=1}^M \int_0^T \{a_0(C_i, t) + \theta_1 a_1(C_i, t) + \theta_2 a_2(C_i, t)\} \{a_1(C_i, t)\} dt &= 0 \\ \sum_{i=1}^M \int_0^T \{a_2(C_i, t)\} \{a_1(C_i, t)\} dt &= 0 \end{aligned} \tag{18}$$

$$\begin{aligned} \sum_{i=1}^M \int_0^T \{a_2(C_i, t)\} dC_i(t) - \sum_{i=1}^M \int_0^T \{a_0(C_i, t) + \theta_1 a_1(C_i, t) + \theta_2 a_2(C_i, t)\} \{a_2(C_i, t)\} dt &= 0 \\ \sum_{i=1}^M \int_0^T \{a_2(C_i, t)\} \{a_2(C_i, t)\} dt &= 0 \end{aligned}$$

Hence, we substitute $a_0(C_i, t)$, $a_1(C_i, t)$, $a_2(C_i, t)$, θ_1 and θ_2 in equations (18) to obtain the following set of equations:

$$\begin{aligned} & \sum_{i=1}^M \sum_{t=0}^T \left\{ \frac{\partial^2 C_i}{\partial x^2} \right\} \Delta C_i - D_L \sum_{i=1}^M \sum_{t=0}^T \left\{ \frac{\partial^2 C_i}{\partial x^2} \right\}^2 \\ & \Delta t - v_x \sum_{i=1}^M \sum_{t=0}^T \left\{ \frac{\partial C_i}{\partial x} \right\} \left\{ \frac{\partial^2 C_i}{\partial x^2} \right\} \Delta t = 0 \\ & \sum_{i=1}^M \sum_{t=0}^T \left\{ \frac{\partial C_i}{\partial x} \right\} \Delta C_i - D_L \sum_{i=1}^M \sum_{t=0}^T \left\{ \frac{\partial C_i}{\partial x} \right\} \left\{ \frac{\partial^2 C_i}{\partial x^2} \right\} \\ & \Delta t - v_x \sum_{i=1}^M \sum_{t=0}^T \left\{ \frac{\partial C_i}{\partial x} \right\}^2 \Delta t = 0. \end{aligned} \quad (19)$$

Therefore, D_L and v_x values can be obtained by solving these two simultaneous equations and K can be calculated by using equation (2).

The first and second order concentration gradients for the above solutions are calculated by using the central difference scheme (Morton & Mayers 1994). The first concentration gradient is

$$\left(\frac{\partial C}{\partial x} \right)_i = \frac{C_{i+1} - C_{i-1}}{2\Delta x}. \quad (20)$$

The second order concentration gradients can be obtained by applying the central difference scheme twice:

$$\left(\frac{\partial^2 C}{\partial x^2} \right)_i = \frac{C_{i+1} - 2C_i + C_{i-1}}{\Delta x^2}. \quad (21)$$

INVESTIGATION METHOD

We explore the stochastic inverse methodology (Unny 1989) by using two different types of data. The first dataset was an artificial dataset that was generated by using a computer model which represent a numerical solution of Equation (4) and (8). This dataset was used to explore the effects of different system noise levels on estimated parameters. Our second dataset was obtained from contaminant transport experiments conducted at a large, confined, artificial aquifer at Lincoln University, New Zealand. This dataset was used for experimental comparisons of the parameter values.

Exploration of noise effect

This exploration was conducted to investigate the effect of system noises of different magnitudes on estimated parameters. The dataset, which simulates real world noisy data, was created by adding noise to a dataset that was generated by deterministic solution of the system. Following is a description of the method used to generate the dataset.

First, deterministic Equations (4) and (8) were used to generate the noise-free concentration values of each space coordinate for all the time steps by using the following numerical procedure. The following example (Equation (22)) shows the calculation of concentration at the i th spatial coordinate at the next time step ($j+1$)th in the two-parameter case:

$$\begin{aligned} C[i][j+1] &= C[i][j] + D_L \frac{dt[j]}{(dx[i])^2} (C[i+1][j] - 2C[i][j] + \\ & C[i-1][j]) - v_x \frac{dt[j]}{2dx[i]} (C[i+1][j] - C[i-1][j]) \end{aligned} \quad (22)$$

where

i = space coordinate,

j = time interval,

$C[i][j]$ = solute concentration at i th space coordinate at j th time step,

$dt[j]$ = time difference between j th and $(j+1)$ th time steps, and

$dx[i]$ = space difference between i th and $(i+1)$ th spatial coordinates.

Because of the instability problems in the finite difference methods (Dietrich & Newsam 1989) we tested the solution for different Δt and Δx combinations to overcome the instability problem. It was apparent that some generated data were affected by the instability problem. However, in most of the cases it was not obvious. Hence, we estimated the parameters based on each dataset that was assumed to be noise-free data. Then we chose the most stable set of data that gave the closest values to the parameter values used to generate the data. The parameter values were estimated using the inverse method described earlier.

Then we added different levels of randomness, which are positive and negative uniformly distributed noise,

to the concentration values to create a set of noisy data. This was done by using two random number generators. Since one of our objectives is to explore the inverse methodology for different noise levels, we created the noisy datasets for different levels of noise. The first noisy dataset was generated with the randomness between $\pm 2\%$ of the deterministic concentration values. The following process was executed to add a noise component. The first random number generator generates a number between 0 and 1. The generated value is multiplied by 2% and the deterministic concentration value to obtain a noise component between 0 and 0.02 (2%) of the original concentration value. Then another random operation selects either the + or - sign which determines whether we add or subtract the noise component to the deterministic concentration value. In other words, the new value can be less than or greater than up to 2% of the original value. Then we used the same procedure to create some more datasets by changing the noise component. The randomness level was gradually increased up to $\pm 50\%$ of the deterministic value. The following example may enhance the clarity of the procedure:

Let deterministic concentration	$= C$
First random number (say)	$= 0.2568$ (between 0 and 1)
Noise component	$= C \times 0.2568 \times 2\%$ (to determine noise up to 2%)
Second random operation	$= -ve$ (select either + or - sign)
Noisy concentration value	$= C - C \times 0.2568 \times 2\%$.

We used the same numerical procedures explained above to obtain the first and second derivatives for each spatial coordinate for noisy datasets. Then the above-mentioned estimation procedure was used to estimate parameter(s) by using the noisy datasets.

Experimental comparison

Our second data set was obtained from experimentally based contaminant transport tests conducted at a large, confined, artificial aquifer at Lincoln University, New Zealand. This aquifer is 9.49 m long, 4.66 m wide and

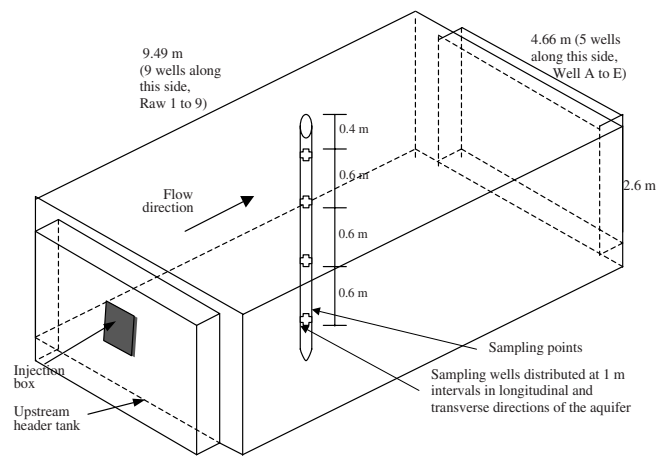

Figure 1 | Schematic diagram of artificial aquifer at Lincoln University, New Zealand.

2.6 m deep. As shown in Figure 1 constant head tanks bound the aquifer at its upstream and downstream ends. A porous wall provides the hydraulic connection between the aquifer and head tanks. A weir controls the water surface elevation in each head tank, and each weir can be adjusted to provide different hydraulic gradients. However, the uniform hydraulic gradient of 0.017 m/9.49 m ($= 0.0018$) was maintained during the entire experiment. All other boundaries are zero flow boundaries. The aquifer media is sand.

Multi-port monitoring wells are laid out on a 1 m \times 1 m grid. Computer controlled peristaltic pumps enable fully automated, simultaneous solute water samples to be collected from sample points that are uniformly distributed throughout the aquifer (four sample points for each grid point at 0.4 m, 1.0 m, 1.6 m and 2.2 m depth from the top surface of the aquifer). The tracer used was Rhodamine WT (RWT) dye with an initial concentration of 200 parts per million and then allowed to decrease exponentially. Tracer was injected at the middle of the header tank by using an injection box (dimensions of 50 cm length, 10 cm width and 20 cm depth). This tracer was rapidly mixed into the upstream header tank and thus infiltrated across the whole of the upstream face of the aquifer. The dye was injected at 12:00 noon on 26 June and samples were collected at 2–4 hour intervals (however, there are some exceptions on time intervals) for 432 h.

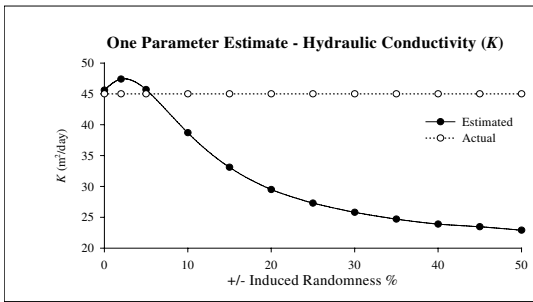

Figure 2 | Actual and estimated parameters at different noise levels.

As shown in Figure 1, the solute concentration data was collected from 45 evenly spaced sample wells at four different depths (altogether data at 180 ($= 9 \times 5 \times 4$) space coordinates). We obtained the average of five data wells along the width of the aquifer at each depth and ended up with 4 different datasets. Each dataset contains data for 9 space coordinates along the aquifer for all time intervals.

RESULTS

The parameter estimates obtained with the first dataset, the computer generated data, show that there is a direct relationship between the estimated parameter values and the amount of noise introduced into the system (Figure 2). The difference between the estimated hydraulic conductivity (K) and the actual K is almost proportional to the percentage of introduced noise in both one-parameter and two-parameter cases.

As shown in Figures 2 and 3 the estimated parameter varies with the introduced noise in almost the shape of a sine curve up to $\pm 5\%$ noise and then follows a pattern of an exponential curve with increasing noise. These two figures very clearly show that estimated parameters are converging with respect to the increase of the noise level: the rate of change (difference) of the estimated parameter is decreasing with the increase in noise. Hence, we would find that a further increase in noise, more than 30%, does not make a significant additional difference to increasing the difference between the actual and estimated parameters.

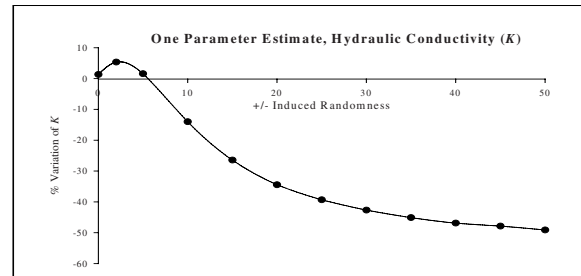

Figure 3 | Percentage variation of estimated parameter with respect to actual parameters for different noise levels.

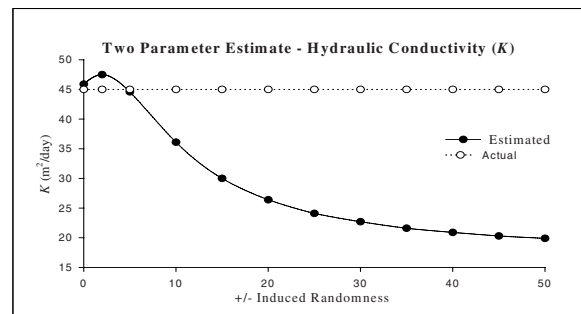

Figure 4 | Actual and estimated parameters, K , for different noise levels in the two-parameter case.

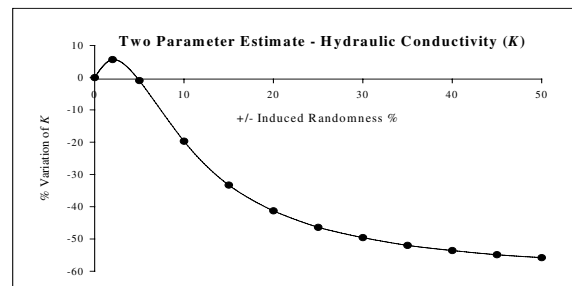

Figure 5 | Percentage variation of the estimated parameter, K , with respect to the actual parameters for different noise levels.

In the two-parameter estimation with the one-dimensional stochastic advection-dispersion equation, the estimated hydraulic conductivity, K , shows that (Figures 4 and 5) its effect on the different noise levels is behaving very similar to the one-parameter case. However, the associated error component is larger in the two-parameter case; there was only a -49% variation of estimated K for $\pm 50\%$ of noise in the one-parameter case and a variation

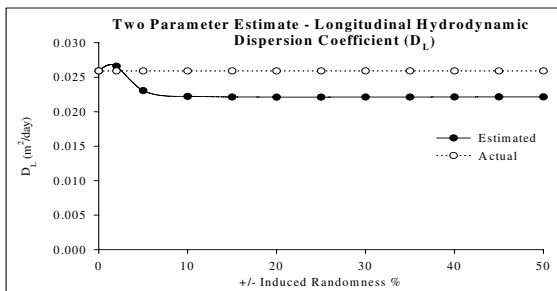

Figure 6 | Actual and estimated parameters, D_L , for different noise levels in the two-parameter case.

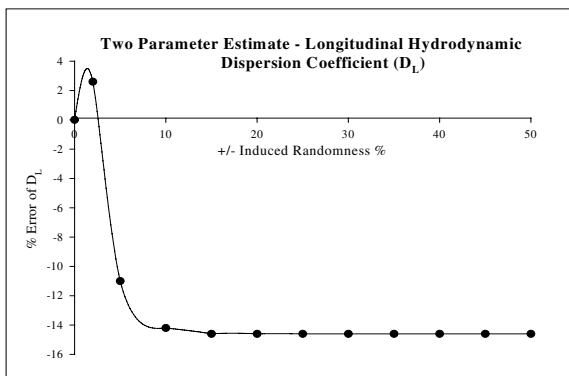

Figure 7 | Percentage variation of the estimated parameter, D_L , with respect to the actual parameters for different noise levels.

of -56% for the two-parameter case for a similar noise level.

The other parameter estimated in the two-parameter case was the hydrodynamic dispersion coefficient parallel to the principal direction of flow (longitudinal), D_L . The estimated D_L shows a similar affect as shown by the estimated parameter K , for noise up to 10% of level: it follows a sine curve variation up to approximately 2.5% of noise and increases the error in the shape of the exponential form up to 10% of noise. However, as shown in Figure 6, an increase in noise beyond 10% does not make any further significant difference in variation of the estimated parameter. Further, as shown in Figure 7, the maximum percentage variation of the estimated parameter value with respect to the actual parameter does not exceed -15% . Therefore, compared to the estimated K , the effect of noise on the estimated D_L is very minimal.

Table 1 | Estimated and experimental parameter hydraulic conductivity, K (m/d), in the one-parameter estimation case.

Depth (m)	Hydraulic conductivity, K (m/d)	
	Estimated parameter	Experimental parameter
0.4	200.6	137
1.0	213.1	137
1.6	221.9	137
2.2	261.6	137

Table 2 | Estimated and experimental parameters hydraulic conductivity, K (m/d), and longitudinal hydrodynamic dispersion, D_L (m^2/d), in the two-parameter estimation case.

Depth (m)	Hydraulic conductivity, K (m/d)		Longitudinal hydrodynamic dispersion, D_L (m^2/d)	
	Estimated	Experimental	Estimated	Experimental
0.4	203.2	137	0.167	0.1596
1.0	210.6	137	0.143	0.1596
1.6	208.9	137	0.134	0.1596
2.2	262.3	137	0.242	0.1596

We conducted the second part of our investigation with the dataset obtained from Lincoln University's artificial aquifer. Results obtained from the one-parameter and two-parameter cases with the advection transport equation and one-dimensional advection-dispersion equation are shown in Tables 1 and 2, respectively. The estimated hydraulic conductivity, K , gives very similar results in both cases for each depth of the artificial aquifer. The estimated parameter K in the one-parameter case shows a pattern of increasing values with depth. The two-parameter case has a similar pattern except at the 1.6 m depth. Estimated D_L values decrease with the depth; however, the value at 2.2 m depth shows a significant increase.

The experimental values of hydraulic conductivity, K , and hydrodynamic dispersion coefficient parallel to the principal direction of flow (longitudinal), D_L , were found

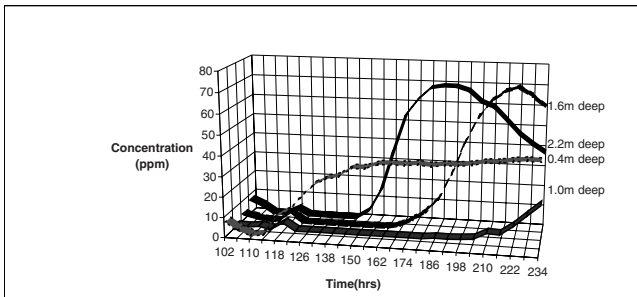

Figure 8 | The concentration values at Row 5—Well B.

to be 137 m/d and 0.1596 m²/d, respectively, assuming the aquifer is homogeneous.

DISCUSSION

Results of the first dataset show that stochastic inverse methodology (Unny 1989) gives reasonably accurate parameter estimates when system noise is present. However, parameter estimation only for one parameter gives more valid results than in the estimations of the two-parameter situation. The significance of the noise level in the groundwater system has a direct relationship to the accuracy of the estimated parameters in the investigated methodology. Hence, when the aquifer is heavily heterogeneous estimated parameters do not reflect the actual values. However, we may have considered the worst case scenario as we have added the noise for almost all the input concentration values. In reality we would be able to take the reading without any noise as well, where some parts of the aquifer are not subjected to the variations.

Comparison of the parameters which were estimated by using our second dataset, experimental data with calibrated parameters, shows mixed results. Estimated D_L values are almost similar to the experimental results. Other estimated parameters, the K values, show a considerable difference. However, Figure 8 shows the concentration values at a well which is very close to the middle of the artificial aquifer. It is very clear that concentration values are not same at all depths and that the aquifer behaviour is not the same at each depth. The graphs of the other wells

show similar heterogeneous behaviour as well. Therefore, we can state that the aquifer is not behaving homogeneously, meaning that the aquifer parameters, such as hydraulic gradient and effective porosity, are not uniformly distributed throughout the system. The variables used to calibrate the aquifer parameters are subjected to randomness and the accuracy of the results could be affected considerably. The reason this artificial aquifer does not behave homogeneously may be due to the method of construction. The aquifer was constructed using sand blocks and they were laid layer by layer. We assume that, even though the material used in the aquifer is uniform, joints between the blocks can create different types of flow patterns and flow lengths. Furthermore, the bottom layers of the aquifer get compressed and can behave differently.

The reason the estimated K values show a considerable difference to the experimental values may be caused by the assumptions made in this study. As shown in equation (2) K is a function of v_x . We estimate the v_x by using equation (16) for the one-parameter case and equation (19) in the two-parameter case. Then equation (2) was used to calculate the value of K . In this calculation, for simplicity we assumed hydraulic gradient, dh/dl , and effective porosity, n_e , as constant values, or in other words their spatial distribution is homogeneous. However, in the aquifer these may be non-linear. This reason may cause considerable differences between the experimental and estimated K values. However, the D_L value in equation (19) is not affected by such assumptions and estimates are similar to experimental results.

Other possible phenomena that can be present in solute transport such as adsorption and the occurrence of short circuits are, for simplicity, assumed to be included in the random component, $\xi(x,t)$ in the governing equations (5) and (9). However, we assumed that in the experiments the tracer was mixed in the upstream header tank, so adsorption in the aquifer could be neglected.

The first order concentration gradients $\left(\frac{\partial C}{\partial x}\right)$ and second order concentration gradients $\left(\frac{\partial^2 C}{\partial x^2}\right)$ can be subject to numerical uncertainty if we do not use an accurate method to calculate them. When dealing with a large number of observation points in complex regional

variation patterns of dependent variables it may be appropriate to use a suitable statistical procedure, such as the least squares method, to best fit the curve for input observation values to calculate concentration gradients. Timothy *et al.* (1965) pointed out that, in complex cases, seventh or eighth degree surfaces may prove useful in obtaining accurate results.

CONCLUDING REMARKS

This paper explored the parameter estimation using the inverse method presented by Unny (1989). The method is an application of the maximum likelihood parameter estimation theory for stochastic differential equations, which describes the groundwater system in the presence of uncertainty. This procedure was applied for the stochastic advection transport equation to estimate a single parameter and for the stochastic one dimensional advective dispersive equation to estimate two parameters. We used two different types of datasets: a computer generated artificial dataset and an experimental dataset. Both explorations show encouraging results in finding estimates for hydraulic conductivity, K , and longitudinal hydrodynamic dispersion coefficient, D_L , by using this inverse method. However, both estimates show that they are affected by the noise component in a proportional relationship. The result of the noise is more effective on K than on D_L . However, the accuracy of the estimates could be improved by using higher degree polynomial surfaces to obtain first and second order spatial gradients.

The main advantage of this method is the direct dependence of the solution variable on field measurements of solute concentration values (or any other value according to each case) over a period of time at discrete spatial locations. We can attempt to overcome the randomness issues which arise from the generally accepted methods such as pumping tests and permeameter tests and the inability to apply those tests to large aquifers.

ACKNOWLEDGEMENTS

The authors are grateful to Dr John Bright and Dr Fuli Wang at Lincoln Environmental, Lincoln University,

New Zealand for giving us the contaminant transport experimental data and other necessary details of the experimental aquifer for this research.

LIST OF SYMBOLS

K	hydraulic conductivity, m/d.
x	space coordinate, m.
$\frac{dh}{dl}$	hydraulic gradient, m/m.
v_x	average linear velocity, m/d.
C	solute concentration, mg/l.
n_e	effective porosity.
t	time (any given), d.
T	total time period that observations conducted, d.
D_L	hydrodynamic dispersion coefficient parallel to the principal direction of flow (longitudinal), m^2/d .
$\xi(x,t)$	zero mean random component accounting for uncertainty of the system.
$d\beta(t)$	Hilbert space valued Wiener incremental process.

REFERENCES

- Basawa, I. V. & Prakasa Rao, B. L. S. 1980 *Statistical Inference for Stochastic Processes*. Academic Press, New York.
- Bear, J., Zaslavsky, D. & Irmay, S. 1968 *Physical Principles of Water Percolation and Seepage*. Unesco Press, Paris.
- Bear, J. 1979 *Hydraulics of Groundwater*. McGraw-Hill Inc, New York.
- Carrera, J. & Neuman, S. P. 1986a Estimation of aquifer parameters under transient and steady state conditions, 1, Maximum likelihood method incorporating prior information. *Wat. Res. Res.* **22**(2), 199–210.
- Carrera, J. & Neuman, S. P. 1986b Estimation of aquifer parameters under transient and steady state conditions, 2, Uniqueness, stability, and solution algorithm. *Wat. Res. Res.* **22**(2), 211–227.
- Dagan, G. 1985 Stochastic modeling of groundwater flow by unconditional and conditional probabilities: the inverse problem. *Wat. Res. Res.* **21**(1), 65–72.
- Dietrich, C. R. & Newsam, G. N. 1989 A stability analysis of the geostatistical approach to aquifer transmissivity identification. *Stochastic Hydrol. Hydraul.* **3**(4), 293–316.

- Freeze, R. A. 1972 Regionalization of hydrogeologic parameters for use in mathematical models in groundwater flow. In: *Hydrogeology* (ed. J. E. Gill). Harpell's, Gardenvale, Quebec.
- Grindrod, P. & Impey, M. D. 1991 *Fractal Field Simulation of Tracer Migration within WIPP Culebra Dolomite*. Intera Information Technology, Henley-upon-Thames, UK.
- Gutjahr, A. L. & Wilson, J. R. 1989 Co-kriging for stochastic flow models. *Transport. Porous Media* 4(6), 585–598.
- Jazwinski, A. H. 1970 *Stochastic Processes and Filtering Theory*. Academic Press, New York.
- Kitanidis, P. & Vomvoris, E. G. 1985 A geostatistical approach to the problem of groundwater modelling (steady state) and one-dimensional simulation. *Wat. Res. Res.* 19(3), 677–690.
- Keidser, A. & Rosbjerg, D. 1991 A comparison of four inverse approaches to groundwater flow and transport parameter identification. *Wat. Res. Res.* 27(9), 2219–2232.
- Kuiper, L. K. 1986 A comparison of several methods for the solution of the inverse problem in two-dimensional steady state groundwater flow modelling. *Wat. Res. Res.* 22(5), 705–714.
- Kutoyants, Yu. A. 1984 *Parameter Estimation for Stochastic Processes*. Herderman Verlag, Berlin.
- Lipster, R. S. & Shirayev, A. N. 1977 *Statistics of Random Processes: Part I. General Theory*. Springer, New York.
- McLaughlin, D. & Townley, L. R. 1996 A reassessment of the groundwater inverse problem. *Wat. Res. Res.* 32(5), 1311–1161.
- Morton, K. W. & Mayers, D. F. 1994 *Numerical Solution of Partial Differential Equations*. Cambridge University Press, Cambridge.
- RamaRao, B. S., LaVenue, A. M., De Marsily, G. & Marietta, M. G. 1995 Pilot point methodology for automated calibration of an ensemble of conditionally simulated transmissivity fields, 1, Theory and computational experiments. *Wat. Res. Res.* 31(3), 475–495.
- Sahuquillo, A., Capilla, J. E., Gomez-Hernandez, J. J. & Andreu, J. 1992 Conditional simulation of transmissivity fields honouring piezometric data. In: *Hydraulic Engineering Software IV, Fluid Flow Modeling*, vol 2 (ed. Blain & Cabrera), pp. 201–214. Elsevier, New York.
- Sun, N. Z. & Yeh, W. W. G. 1992 A stochastic inverse solution for transient groundwater flow: parameter identification and reliability analysis. *Wat. Res. Res.* 28(12), 3268–3280.
- Timothy, W. E. H., Krumbein, W. C., Irma, W. & Beckman, W. A. Jr. 1965 *A surface fitting program for areally distributed data from the earth sciences and remote sensing*. Contractor report, NASA.
- Unny, T. E. 1989 Stochastic partial differential equations in ground water hydrology—Part 1. *J. Hydrol. Hydraul.* 3, 135–153.
- Yew, W. W. G. 1986 Review of parameter identification procedures in groundwater hydrology: the inverse problem. *Wat. Res. Res.* 22(2), 95–108.
- Young, N. 1988 *An Introduction to Hilbert Space*. Cambridge University Press, Cambridge.
- Zimmerman, D. A., De Marsily, G., Gotway, C. A., Marietta, M. G., Axness, C. L., Beauheim, R. L., Bras, R. L., Dagan, G., Davies, P. B., Gallegos, D. P., Galli, A., Gomez-Hernandez, J., Gringord, P., Gutjahr, A. L., Kitanidis, P. K., Lavenue, A. M., McLaughlin, D., Neuman, S. P., RamaRao, B. S., Ravenne, C. & Rubin, Y. 1998 A comparison of seven geostatistical based inverse approaches to estimate transmissivities for modelling advective transport by groundwater flow. *Wat. Res. Res.* 34(6), 1373–1413.