



Discussion

A Vision for a Secure Transportation System Without Hydrogen or Oil

R. E. West

Department of Chemical and Biological Engineering,
University of Colorado at Boulder,
Boulder, CO 80302

Frank Kreith¹

Department of Mechanical Engineering,
University of Colorado at Boulder,
Boulder, CO 80302

1 Introduction

Our way of life is on a collision course with geological limitations. Ever since petroleum geologist M. King Hubbard correctly predicted in 1956 that U.S. oil production would reach a peak in 1973 and then decline [1], scientists and engineers have known that worldwide oil production would follow a similar trend. Today, the only question is when the world peak will occur.

The U.S. transportation system depends almost entirely (~97%) on oil [2], and foreign imports have risen steadily since 1973 as the demand increased and domestic supplies decreased. Today, more than 60% of U.S. oil consumption is imported and the dependence on foreign oil is bound to increase. There is no question that once the world peak is reached and oil production begins to drop, either alternative fuels will have to be supplied to make up the difference between demand and supply, or the cost of fuel will increase precipitously and create an unprecedented social and economic crisis for our entire transportation system.

Among energy analysts the above scenario is not in dispute. There is, however, uncertainty about the timing. Bartlett [3] has developed a predictive model based on a Gaussian curve similar in shape to the data used by Hubbard as shown in Fig. 1. The predictive peak in world oil production depends only on the assumed total amount of recoverable reserves. According to a recent analysis by the Energy Information Agency [4], world ultimately recoverable oil reserves are between 2.2×10^{12} barrels (bbl) and 3.9×10^{12} bbl with a mean estimate of the USGS at 3×10^{12} bbl. But changing the total available reserve from 3×10^{12} bbl to 4×10^{12} bbl increases the predicted time of peak production by merely 11 yr, from 2019 to 2030. The present trend of yearly increases in oil consumption, especially in China and India, shortens the window of opportunity for a managed transition to alternative fuels even further. Hence, irrespective of the actual amount of oil remaining in the ground, peak production will occur soon

¹Corresponding author.

Contributed by the Petroleum Engineering Division of ASME for publication in the JOURNAL OF ENERGY RESOURCES TECHNOLOGY. Manuscript received February 5, 2006; final manuscript received April 10, 2006. Review conducted by Andrew K. Wojtanowicz.

and the need for starting to supplement oil as the primary transportation fuel is urgent because an orderly transition to develop petroleum substitutes will take time and careful planning.

Some analysts claim that hydrogen can take the place of petroleum in a future transportation system [5,6]. But in previous publications, the authors have shown that hydrogen is inferior as an energy carrier to electricity [7] and that the energy efficiency of hydrogen vehicles, especially if the hydrogen were produced by the electrolysis of water, is considerably less than the efficiency of hybrid electric vehicles or fully electric battery vehicles [7]. The results of these analyses have subsequently been confirmed by other studies, particularly those by Hammererschlag and Mazza [8] and Mazza and Hammerschlag [9].

Before hydrogen could become a useful automotive fuel, an entirely new system of energy production and distribution on twice the scale of today's electric power generating stations and distribution grid would have to be built. It has been estimated that a hydrogen transmission and storage system to fuel only 50% of the automotive fleet by the year 2020 would cost at least \$600 billion [10] and that to make the hydrogen by electrolysis would require doubling the electric power generation rate [11]. There is no question that a paradigm shift in fuel for worldwide transportation is imperative, and before embarking on such a huge investment, it is prudent to compare the hydrogen option with alternative ways to provide the energy and/or fuel needed by the transportation system.

This paper presents and analyzes two generic approaches to meet the future demand of the U.S. ground transportation systems that do not require hydrogen, can use existing transmission infrastructure, and can eventually reduce CO₂ emission drastically with a renewable energy system. Both these pathways are examined from an energetic and environmental perspective and are shown to be superior to the hydrogen economy on both these criteria. The first approach is a demand-side strategy based on the use of electric hybrid vehicles, an energy-efficient vehicle configuration, combined with a liquid fuel. This approach could use the existing liquid-fuel distribution system, but would need an expanded and robust electric-transmission system, albeit on a smaller and much more economical scale than a hydrogen fuel-cell infrastructure. The second approach is a supply-side strategy, based on synthetic fuel generation that can use initially coal or natural gas as the energy source, but can eventually transition to renewable biomass sources. The two pathways are not mutually exclusive, but can be combined into a secure and efficient future transportation system as will be shown in this paper.

Cradle-to-grave energy efficiency is an important criterion for comparing energy-source utilization pathways because if a pathway is less efficient than another pathway that accomplishes the same final goal from the same amount of primary energy, then the less efficient pathway requires more primary energy to accomplish the same end. Hence, if the primary energy source is nonrenewable, then the less efficient pathway leaves less of the energy source for the future. It also means that more pollution is produced and the cost for the final end use is likely higher. However, if the primary energy source is renewable, then the efficiency does

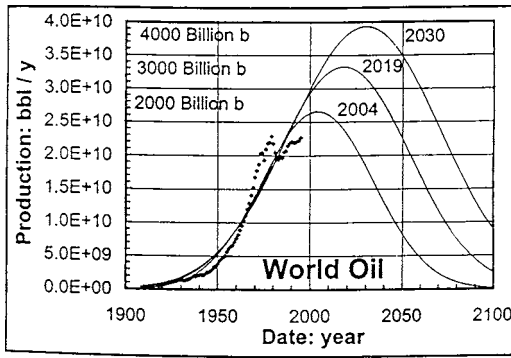

Fig. 1 Estimates of world oil production as a function of time for various amounts of ultimate recovery

not change the amount of primary energy available in the future and energy efficiency does not have the same significance for renewable energy sources as for nonrenewable sources. Efficiency is, of course, important because the cost of delivering the energy is usually strongly influenced by the system efficiency. But a comparison between renewable and nonrenewable pathways should be based on economic and environmental criteria, such as cost and CO₂ generation.

2 Effect of Introducing Hybrid or Electric Vehicles on Gasoline Consumption

In order to demonstrate the urgency for initiating a plan to supplement oil as soon as possible, we have made calculations to predict the potential gasoline savings based on the very optimistic scenario that, at an arbitrary starting time, all new light vehicles sold in the U.S. would be either hybrid or electric vehicles. The term "light vehicles" as used here includes all automobiles, family vans, sports utility vehicles, motorcycles, and pickup trucks. This scenario is an extreme case to show that because of the slow turnover of the light-vehicle fleet, it takes a long time for a significant impact on gasoline consumption to occur. The following cases are considered: (i) All new vehicles sold are gasoline-electric hybrid vehicles (HEV); (ii) all new vehicles sold are plug-in, gasoline-electric hybrids with a 20 mil electric-only range (PHEV20); (iii) all new vehicles are diesel-electric hybrids (DHEV) with diesel fuel from coal or biomass; (iv) all new vehicles are plug-in, diesel hybrids with a 20 mil all-electric range (PDHEV20); or (v) all new vehicles are all-electric vehicles (EV).

The calculations use a rate of new vehicle sales of 7% of the fleet per year, a retirement rate of 5%/y, and a resulting net increase in total vehicles of 2%/y. These numbers represent an approximate fit to the light-vehicle sales and total number data for the years 1966 to 2003 reported by the U.S. government [12]. All calculated results are presented in percentages and are therefore independent of the time at which all new vehicle sales switch to hybrids or EVs. When new car sales begin to be all hybrids or all EVs, it is assumed that the future rate of retirement of vehicles from the all-gasoline fleet is 5%/y of the remaining gasoline vehicles. The all-gasoline fleet is therefore completely retired 20 years later. The yearly rate of retirement of hybrid or EV vehicles is then 5% of the total number of vehicles at the beginning of that year, less 5% of the number of gasoline vehicles at the beginning of year zero. Thus, in year zero, no hybrid or EVs are retired.

The following average vehicle mileage values were used: gasoline fleet, 21 mpg (miles per gallon); gasoline HEV, 41 mpg; gasoline PHEV 20, 56 mpg of gasoline [13]. A mileage is not needed for the EVs, or the diesels, since neither use gasoline, and we assume that the diesel fuel will be derived from nonpetroleum sources, as discussed in Secs. 3 and 4.

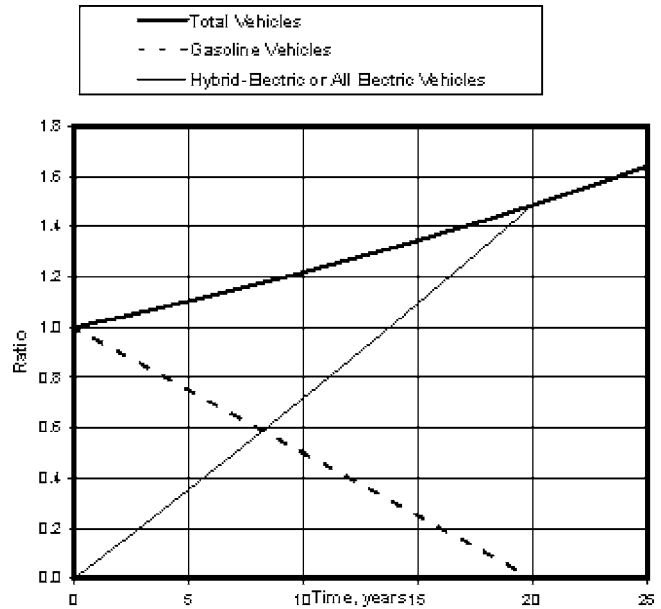

Fig. 2 Ratio of number of vehicles to number at time zero. Scenario: Starting in year zero, all new vehicles are hybrid or electric.

The results of these calculations are presented in Figs. 2–4. Figure 2 shows the ratio of the total number of vehicles in the fleet, the number of all-gasoline vehicles in the fleet, and the number of hybrid or EV vehicles in the fleet to the total number in the fleet as a function of time. The total number of vehicles increases by over 60% in 25 years at the assumed 2%/y net increase while the number of all-gasoline vehicles decreases linearly from 100% initially to 0% after 20 y. The number of hybrid or EV vehicles increases from 0% initially to 58% in 10 y and 100% in 20 y. This graph emphasizes how long it takes for the introduction of a new vehicle type to show a significant impact on the composition of the vehicle fleet, even when only the new vehicle types are sold

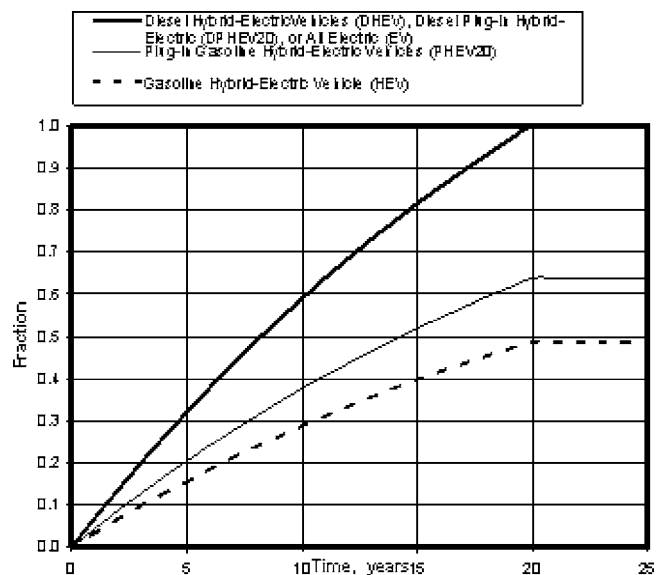

Fig. 3 Annual gasoline savings as a fraction of the gasoline usage by an all-gasoline fleet in the same year. Scenario: Starting in year zero, all new vehicles are hybrid or electric.

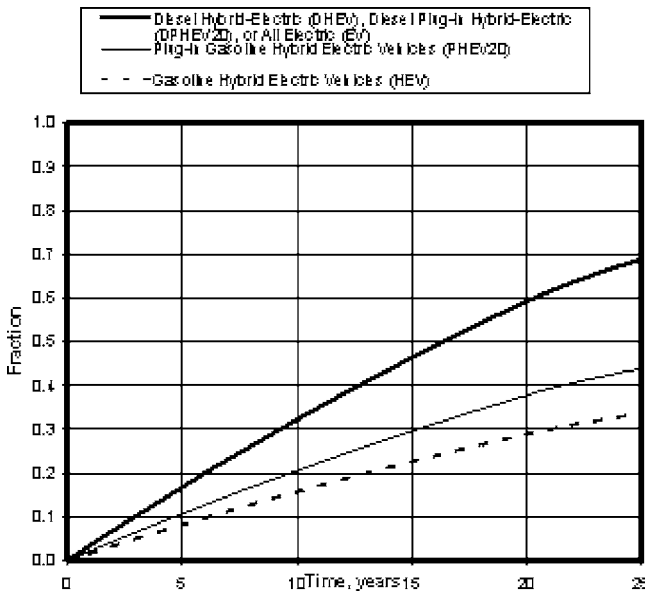

Fig. 4 Cumulative gasoline savings as a fraction of the cumulative usage by an all-gasoline fleet. Scenario: Starting in year zero, all new vehicles are hybrid or electric.

after a starting point. This slow turnover of the fleet is the fundamental reason that the effects on gasoline consumption show up so slowly.

Figure 3 shows the annual reduction in gasoline consumption as a function of time. Note that for HEVs the annual savings in gas consumption is 29% of the gasoline consumption for a conventional fleet in the tenth year and becomes constant at 49% in the twentieth year. Figure 3 also shows that the plug-in gasoline hybrid scenario saves 41% of the usage in the tenth year and increasing to 64% in the twentieth year and thereafter. Clearly, 10 y after starting to sell only hybrid or EV vehicles, the impact of the HEV or PHEV20 scenarios on gasoline consumption is still rather small. After 20 yr, the impact becomes significant, but gasoline consumption still remains high for gasoline hybrids. The total number of vehicles and the consumption (with the assumption of no efficiency improvement) by an all-gasoline fleet will have increased by more than 60%, but even the PHEV20 savings is only 40% of the zero-time annual-rate of gasoline consumption. The DHEV, DPHEV20, and EV scenarios show 59% annual savings in the tenth year and 100% in the twentieth year and thereafter. As would be expected, the nongasoline vehicles have a much greater impact on gasoline usage than gasoline-using HEVs, and the impact occurs more rapidly.

Figure 4 gives the cumulative gasoline savings for the various scenarios compared to an all-gasoline fleet. HEVs save cumulatively 16% after 10 yr and 20% after 20 years. Because of the cumulative savings, HEVs would use in 28 yr the same amount of gasoline as an all-gasoline fleet would use in 20 yr. PHEV20s save 21% after 10 yr and 38% after 20 yr. These results emphasize the relatively small effect on gasoline consumption that these highly optimistic scenarios have in the first decade after implementation. DHEVs, DPHEV20s, and EVs, the options without any gasoline use, save cumulatively as much as 32% after 10 yr and 59% after 20 yr.

3 Hybrid Electric Vehicles and Battery Technology

A 2004 report of the Committee on Alternatives and Strategies for Future Hydrogen Production and Use [14], prepared under the auspices of the National Research Council (NRC), concluded that the vision of a hydrogen economy is based on the expectation that hydrogen can be produced from domestic energy sources in a

manner that is “both affordable and environmentally benign.” An analysis of currently available technologies for achieving this goal [7] showed that irrespective of whether fossil fuels, nuclear fuels or renewable technologies are used as the primary energy source, hydrogen is inefficient compared to using the electric power or heat from any of these sources directly. Given these facts, it is important to note that the NRC report also stated that “If battery technology improves dramatically, all-electric vehicles might become the preferred alternative (to fuel cell electric vehicles).” The report also noted that “Hybrid vehicle technology is commercially available today and can therefore be realized immediately.” If synthetic fuels made from coal, natural gas, or biomass were used in place of gasoline in hybrid vehicles, the consumption of oil could be reduced immediately and eventually eliminated. In the light of these observations, it is therefore important to examine what the current state of battery technology is, what can be expected in the near future, and how these developments affect the potential of hybrid vehicle performance and economics.

To assess the performance of a battery for electric vehicles, the following characteristics have to be considered:

- Specific energy, a measure of the battery weight in units of watt hours per kilogram
- Energy density, a measure of the space the battery occupies in watt hours per cubic meter
- Capacity, the total quantity of energy a battery can store and later deliver in watt hours
- Efficiency, the ratio of energy that can be extracted from the battery to the initial energy input to change the battery
- Specific power, the rate at which the battery can deliver the stored energy per unit weight of battery in watts per kilogram
- Battery lifecycle, the number of charge and discharge cycles that a battery can sustain during its life

A significant effort to replace oil as a transportation fuel was undertaken ten years ago in California, when the California Air Resources Board [CARB] mandated that a certain percentage of all vehicles sold in California had to have zero tailpipe emissions [15]. At that time the only technology available to meet the mandate was the all battery electric vehicle [BEV], which required no gasoline for its operation. The experiment to mandate the use of BEVs in California failed because the technology was not ready for commercialization. The best battery available in 1995 (fluted-tubular lead acid) had an energy storage density of 35 Wh/kg, a specific power of 100 W/kg, and a life cycle of 600–1000 cycles. With these battery characteristics, the maximum range of a BEV was only 50 mil, and the battery pack required replacement every 25,000 mil at a cost of between \$7000 and \$8000 for an average BEV [16]. Since that time, new batteries have been developed by Panasonic, VARTA, and SAFT, that have twice the energy-storage density, three times the specific power, and two or three times the cycle life of the lead acid batteries sold in California, as shown in Table 1 [13].

In addition to the advanced batteries, a new concept has been developed that combines the best qualities of hybrid and battery vehicle technologies. This “plug-in hybrid vehicle” can recharge vehicle batteries during off-peak hours, and since most cars are parked 90% of the time, there are plenty of charging opportunities at both home and the workplace. Furthermore, a large portion of the electric generation infrastructure is only needed for peak demands and lays idle much of the time. Hence, if charging automobile batteries occurred during off-peak hours, they would level out the load of the electric production system and reduce the average cost of electricity [17]. Moreover, plug-in hybrid vehicles are not range limited because they have an engine that can refuel at existing gas stations to use when the batteries are low.

Table 2 Net present value of life-cycle costs over 117,000 mil per 10 yr for conventional gasoline(CV), HEV, and PHEV20 mid-size vehicles (extracted from Ref. [13])

Vehicle type	CV (\$)	HEV (\$)	PHEV 20 (\$)
Battery module cost (\$/kWh)	–	385 ^a	316 ^a
Incremental vehicle cost	–	(547)	224
Energy storage system cost	60	3047	3893
Fuel costs	5401	3725	2787
Maintenance costs	5445	4733	4044
Battery salvage costs	–	(54)	(43)
Total lifecycle costs	10,906	10,904	10,905

^aBattery module price at which life-cycle parity with CV occurs.

3.1 Efficiency and Performance of Plug-in Hybrid Electric Vehicles (PHEV). The efficiency of a PHEV depends on the number of miles the vehicle travels on liquid fuel and electricity, respectively, as well as on the efficiency of the prime movers according to

$$\eta = \frac{\text{energy to wheels}}{\text{energy from primary source}} = f_1 \eta_1 \eta_2 + f_2 \eta_3 \eta_4 \quad (1)$$

where η_1 is the efficiency of the primary source of electricity, η_2 is the efficiency of transmitting electricity to the wheels, f_1 is the fraction of energy supplied by electricity, f_2 is the fraction of energy supplied by fuel $= (1 - f_1)$, η_3 is the efficiency of primary source to fuel, and η_4 is the efficiency of fuel to wheels.

PHEVs can be designed with different all-electric ranges. The distance, in miles, that a PHEV can travel on batteries alone is denoted by a number after PHEV. Thus, a PHEV20 can travel 20 mil on fully charged batteries without using the gasoline engine. According to a study by EPRI [13], on average 1/3 of the annual mileage of a PHEV20 is supplied by electricity and 2/3 by gasoline. The percentage depends, of course, on the vehicle design and the capacity of the batteries on the vehicle. A PHEV60 can travel 60 mil on batteries alone, and the percentage of electric miles will be greater as will the battery capacity.

The tank-to-wheel (more appropriately, battery-to-wheel) efficiency for a battery all-electric vehicle according to EPRI [13] is 0.82. In a previous analysis by the authors [18], the efficiency in 1993 was only 0.49. Comparing these results shows the enormous improvements in the electric component efficiency (controller 87%, battery 90%, charger 90%, drivetrain 90%). When these numbers are multiplied by a hybrid-weight-times-idle factor of 1.3 [19], the overall efficiency of an electric hybrid is 82%, the same as that used in the EPRI study [13]. It is important to note that currently all-electric vehicles can be nearly twice as efficient as when [18] was published.

Table 1 Characteristics of Current Battery for Medium Power Design

	NMH Panasonic	NMH VARTA	Li Ion SAFT
Cell size (Ampere-Hours)	28	45	30
Specific energy (Wh/kg)	58	50	100
Specific power (W/kg)	300	220	950
Cycle life (80% DOD)	>1,500	>2,000	1000(?)
Status	lvp(1999)	pp(1998)	d(1999)

lvp - low volume production
pp - prototype production
d - development
DOD - depth of discharge
NMH - Nickel-Metal-Hydride
Li-ion - Lithium ion

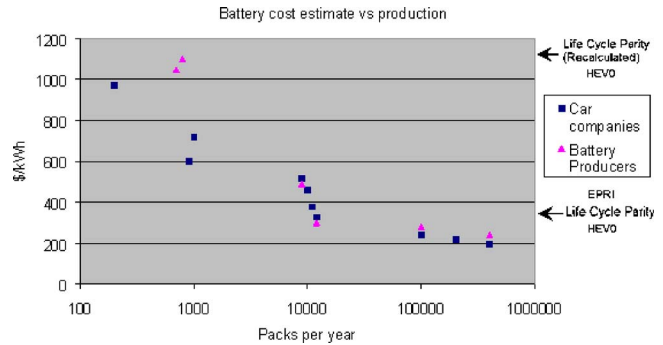

Fig. 5 Battery cost estimate versus production

3.2 Comparison of Present Value of Life-Cycle Costs. Given the potentials for plug-in hybrid vehicles, the Electric Power Research Institute [13] conducted a large-scale analysis of the cost, the battery requirements, and the economic competitiveness of plug in vehicles today and within the near term future. Table 2 presents the net present value of life-cycle costs over ten years for a mid-sized combustion vehicle [CV], hybrid vehicle [HEV] and a plug in electric vehicle with a 20 mil electric-only range [PHEV20]. The battery module cost in dollars per kilowatt hour is the cost at which the total life-cycle costs of all three vehicles would be the same. Figure 5 presents cost estimates for nickel metal-hydrate battery modules as a function of number of units produced per year. According to this projection, a production volume of about 10,000 units per year units would achieve the necessary cost reduction to make both hybrid electric vehicles and plug in electric vehicles economically competitive.

Table 3 presents the electric and plug-in hybrid vehicle battery requirements that would be necessary to make electric vehicles cost effective for medium-size vehicles according to EPRI [13]. As shown in Table 1, the characteristics of nickel metal-hydrate (NiMH) batteries, and lithium ion (Li-ion) batteries are already able to meet the required cost and performance specification. The battery characteristics shown in Table 1 and Fig. 5 are several years old, and it is likely that more up-to-date information from manufacturers would show improvements. Furthermore, the EPRI study assumed a baseline current gasoline cost of \$1.75/gal. A reevaluation of the analysis based on a gasoline cost of \$2.50/gal indicates that the permitted battery price at which the net present values of conventional internal combustion (IC) vehicles and bat-

Table 3 Electric and hybrid vehicle battery requirements (module basis) for cost estimates in Table 2 (extracted from Ref. [13])

Requirement Parameter	HEV	PHEV20	PHEV60
Vehicle ZEV range (mil)	0	20	60
Battery capacity (kWh)	<3	6	18
Cell size ^a (amp-hr)	5–10	15–30	45–90
Specific energy (Wh/kg)	>30	~50 (>=50)	~70 ^b (>=110)
Specific power (W/kg)	~1000	~440 (700 ^c)	~390 (390 ^d , 550 ^e)
Cycle life, deep (80% DOD)	na	>=2500	>=1500
shallow (±100 Wh)	200 k	200 k	200 k

^aCell-size ranges correspond to an assumed battery voltage range of 400–200 V. Cell size of 30 amp-h with 200 V battery is equivalent to 6 kWh of capacity.

^bWith a battery of 70 Wh/kg, PHEV-60 vehicle weighs about 100 kg more than corresponding conventional vehicle.

^cHigher specific power required because of higher power requirement for battery-only mode.

^dSpecific power sufficient for battery-only mode power requirement of 70 Wh/kg battery.

^eHigher specific power required for battery-only mode power requirement of 110 Wh/kg battery.

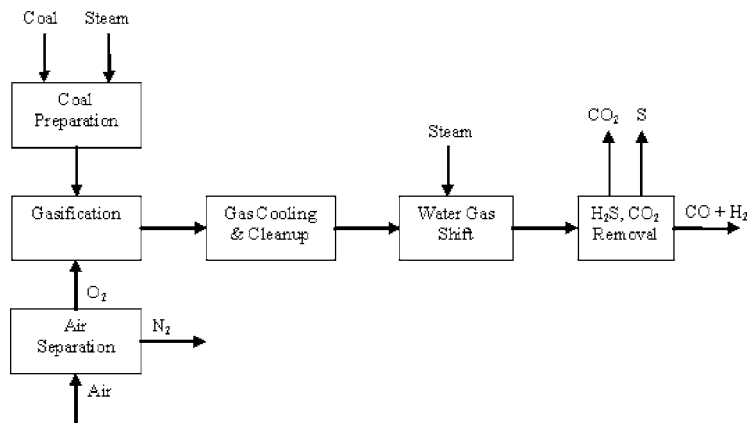

Fig. 6 Schematic of coal gasification process

tery vehicles are equal would go up from \$385 to \$1135 for an HEV and from \$316 to \$1648 for a PHEV 20. Figure 5 shows the cost estimates for batteries versus production for nickel-metal-hydride batteries. Hence, it seems that the cost of HEVs and PHEVs with presently available batteries is already competitive with that of IC engine vehicles.

Moreover, The EPRI analysis is conservative because it compared the performance of all battery electric and plug in hybrid vehicles only to currently available internal combustion engines. But, as shown in Ref. [18], the use of diesel engines in a hybrid configuration would increase the efficiency of operation compared to a hybrid with IC engine and decrease the amount of fuel required. Hence, it may be concluded that the EPRI analysis is conservative. Although it includes advanced batteries, it does not include the increased efficiency achievable by using diesel engines instead of internal combustion engines. Furthermore, diesel fuel, as will be shown in Sec. 4, can be produced from coal or renewable sources as can the electric power required for charging the batteries. The introduction of renewables to produce the energy is beyond the scope of this paper. But, it is clearly feasible and can be achieved gradually as renewable technologies become more cost effective and fossil fuels more expensive.

4 Conversion of Coal, Natural Gas, or Biomass to Vehicle Fuels

Coal, natural gas (NG), and biomass can be transformed chemically into liquid fuels. Coal, the most abundant fossil fuel in the U.S., is presently used almost exclusively to generate electricity. In order to make coal into a vehicle fuel, it must first be converted to a synthesis gas by a process of "gasification." The gaseous product of this process may then be reacted to one of several chemical products that can be used as vehicle fuel. Also, biomass and natural gas can be used instead of coal or combined with coal to make these fuels. Coal gasification and several conversion processes are discussed below.

Natural gas can be used as a vehicle fuel, or it can be reacted with steam to make synthesis gas, which can be used to produce fuels in essentially the same manner as described below for coal. The gas-to-liquid (GTL) technology is well developed as shown by the recent announcement [20] of four major projects, each of which will utilize natural gas, which is currently flared to produce liquid fuel. These projects include SASOL and Qatar Petroleum, a 34,000 bbl/day plant in Qatar, of which 22,000 bbl/day is diesel fuel; Chevron Texaco Corp., 34,000 bbl/day in Nigeria; Shell GTL Ltd. With Qatar Petroleum, a 140,000 bbl/day liquid-fuels plant with an estimated \$6 billion investment; and ExxonMobil Corp. a 154,000 bbl/day GTL plant (about half diesel fuel) with the State of Qatar, with an investment estimated at \$7 billion. The processing of natural gas to make vehicle fuels was discussed in

an earlier paper by the authors [18], and some of those results are presented later for comparison with coal as the fuel source. It should also be noted that biomass can be gasified either alone or in combination with coal and converted to liquid fuels by the same process as coal, or it can also be pyrolyzed and then processed into vehicle fuels as described in [21].

4.1 Coal or Biomass Gasification. Gasification is a well-developed process that is a common feature in the production of synthetic liquid fuels from coal for transportation [22]. The coal gasification process is shown schematically in Fig. 6. It involves reacting a feedstock, such as coal or biomass, with steam to produce "synthesis gas" (carbon monoxide and hydrogen). This gas can be separated to obtain hydrogen or reacted further to make methanol, dimethyl ether (DME), or Fischer-Tropsch diesel. Methanol can be used as a transportation fuel in spark ignition (SI) engines, but this study focuses on diesel fuel because compression ignition engines are more efficient.

In the first step of the process, coal is gasified with limited oxygen to produce syngas, mainly carbon monoxide and hydrogen. The sulfur contained in the coal is converted to hydrogen sulfide gas, and metals are removed as slag. In the "water-gas shift reaction" carbon monoxide is reacted with steam to produce carbon dioxide and additional hydrogen. The carbon dioxide and hydrogen sulfide are removed from the process and vented to the atmosphere or converted into by-product sulfur. The carbon dioxide that is generated in this process is separated from the product in a concentrated form, convenient for sequestration. Thus, it can be prevented from entering the atmosphere.

Coal plant construction, product synthesis, and refining are the main capital costs when liquid fuel is produced from coal. The estimated time of construction for a plant is four to five years. The capital investment depends on the production capacity of the facility. For example, the capital cost of a coal-gasification Fischer-Tropsch synthesis plant with a capacity to produce 20,000 barrels of liquid fuel per day is estimated to be of the order \$1.2 billion [23,24].

Opponents of coal gasification claim that there will be excessive greenhouse gas pollution from the process. However, in the future vehicle fuel-cycle emissions of carbon dioxide can be reduced below those of gasoline-only powered vehicles, by the use of plug-in hybrid electric vehicles and by sequestration of the carbon dioxide from the fuel production process.

4.2 Dimethyl Ether. Dimethyl Ether (DME) is a synthetic diesel fuel that can be made from coal gasification by further processing of synthesis gas. The "syngas" is first reacted to make methanol, which can then be dehydrated to produce DME. The unconverted syngas is sent back to the methanol synthesis, and the purge gas is burned to produce electricity for the gasification pro-

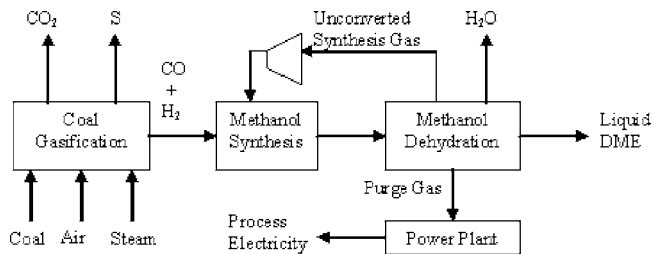

Fig. 7 Schematic of coal gasification and methane synthesis to produce dimethyl ether (DME)

cess, as shown in Fig. 7. DME is a gas at ambient conditions but can be liquefied under mild pressure (150–200 psi) and then can be handled similarly to other liquid fuels.

The properties of DME make it an excellent fuel for compression ignition engines. It is similar to petroleum-derived diesel, but has a 16–33% higher cetane number [22]. The cetane number relates to the propensity of a fuel to autoignite. With higher cetane numbers, combustion of the fuel occurs earlier after injection and NO_x emissions are diminished as a result of lower combustion temperatures. The lower combustion temperature also aids in cold starts by eliminating the need for glow plugs to help ignite the fuel.

4.3 Fischer-Tropsch Diesel. The Fischer-Tropsch (FT) process shown in Fig. 8 converts coal into liquid fuel. The process was invented by German scientists before World War I and is used

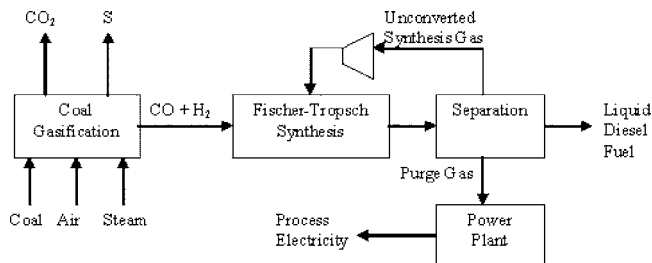

Fig. 8 Schematic of Fischer-Tropsch (FT) synthesis to produce FT diesel from coal

Table 4 Mine-to-tank or well-to-tank efficiency of providing liquid fuels from coal and natural gas to vehicle tank percent^a

Processing step	Hydrogen from		Efficiency, Percentage					
	Coal	NG	Methanol from Coal	NG	DME from Coal	NG	FT Diesel from Coal	NG
Coal or NG production	98[25]	95[18]	98[25]	95[18]	98[25]	95[18]	98[25]	95[18]
Conversion to new fuel	60[22]	78[18]	56[22]	62[18]	55[22]	61 ^b	50[22]	56[18]
Distribution, storage and compression or liquefaction	Gas 83[7] Liquid 76[7]	Gas 83[7] Liquid 76[7]	97[18]	97[18]	96 ^c	96 ^c	97[18]	97[18]
Overall well (or mine)-to-tank	Gas 49 Liquid 45	Gas 62 Liquid 57	53	57	52	56	48	52

^aNumbers in square brackets refer to the reference from which the efficiency was obtained. For Hydrogen, the overall efficiency for the gaseous fuel as well as liquid is given for comparison.

^bDME-to-methanol efficiency ratio from NG efficiency is estimated as the same as the DME-to-methanol efficiency ratio from coal.

^cDME storage efficiency is estimated as the same as other fuels less one percentage point to allow for the modest pressure required to keep DME liquid.

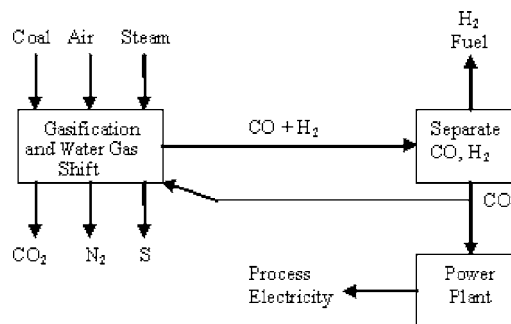

Fig. 9 Coal gasification with synthesis gas separation to produce hydrogen

today in South Africa by SASOL to make diesel fuel [22].

The Fischer-Tropsch reaction uses synthesis gas to make a liquid fuel consisting of ~75% synthetic diesel fuel, which is similar to petroleum-based diesel, and 25% naphtha, which is used to make synthetic gasoline [7]. The unconverted syngas is separated from the liquid FT diesel and recycled to the FT reactor. The purge gas resulting from separation is burned to produce electricity for the gasification process.

4.4 Hydrogen. Hydrogen can be made from coal by gasification followed by synthesis gas separation. After the hydrogen sulfide gas and carbon dioxide are removed from the synthesis gas, unconverted carbon monoxide and hydrogen are separated. The hydrogen can be stored and the carbon monoxide can be burned for electricity and/or recycled back to the water-gas shift reaction, as shown in Fig. 9.

To store and transport the hydrogen, it is necessary either to compress it to ~8000 psi or to liquefy it at a cryogenic temperature below 33 K. The efficiency of the first option is 86%, while the second is ~78% efficient [7]. Both compressed and liquefied hydrogen have been proposed for fuel storage in a board of hydrogen fuel-cell vehicles [5].

4.5 Efficiency of Conversion of Coal or Natural Gas to Vehicle Fuels. Energy is lost in the conversion of coal or natural gas into a vehicle fuel. The energy efficiency of these conversion processes is important in determining the overall well (or mine) to wheel efficiency of these alternative pathways. Table 4 presents

well-to-tank or mine-to-tank efficiency for producing various fuels from coal or natural gas. Williams and Larsen [21] have reported the mass and energy balances for coal-to-fuel conversions with sequestration of the carbon-dioxide by-product, and their values are used here. Kreith et al. [18] previously presented efficiencies for natural gas conversions without carbon-dioxide sequestration. Williams and Larsen [21] estimated that sequestration of CO₂ reduces the efficiency of coal-to-fuel conversion by about two percentage points. Since natural gas produces only about half as much carbon-dioxide per product unit of energy as coal, it has been assumed that carbon monoxide sequestration will reduce the efficiency of carbon-dioxide conversion to fuels by one percentage point. Thus, one percentage point has been subtracted from values reported by Kreith et al. [18] to obtain the values shown in Table 4. In the absence of data for the conversion of natural gas to DME, the authors assumed that the ratio of the conversion efficiencies (DME/methanol) for natural gas is the same as that for coal (0.54/0.56) to estimate this efficiency as shown in Table 4.

Table 4 demonstrates that the production of liquid fuels from natural gas is more efficient than from coal. But NG is in short supply worldwide, and the technology is not a long-term option. It is attractive, however, for utilizing the NG that is currently flared uselessly into the atmosphere in some gasoline distillation plants. The construction of some of these plants has already been announced [20]. But coal-to-liquid production is the more attractive process for the longer term and does not require hydrogen as a fuel or energy carrier. Today, SASOL Ltd., the world's largest maker of motor fuel from coal, produces 160,000 bpd at the world's only commercial coal-to-liquid refinery, in Secunda, South Africa. The 50 yr old plant provides 28% of South Africa's supplies of such fuels as diesel, gasoline, and kerosene. The economic and thermodynamic advantages of coal gasification have recently been recognized. U.S. Senators Santorum and Specter recently announced authorization for a coal-to-liquid fuel plant in Pennsylvania using Fisher-Tropsch technology (www.ultracleanfuels.com/articles/sensant_072905.htm). SASOL Ltd. and Royal Dutch Shell, Plc, are to license the project that will have a capacity to produce 5000 bpd of diesel fuel. Shell Global Solutions has licensed 14 gasifiers in China.

A recent NRC study analyzed other technologies that could produce synthetic fuels from cellulosic biomass [25] and Ref. [26] presents a comparison of the energy return on energy investment for ethanol production from corn and cellulose matter. These projects indicate significant progress in synthetic fuels. But the steps taken thus far for synthetic fuel production need to be multiplied manifold before synthetic fuels can make up for the inevitable gap between demand and supply of gasoline after the peak in oil production is passed.

5 Conclusions and Recommendations

Based on the analysis presented in this paper, we offer the following conclusions and recommendations:

1. World oil production is expected to peak within the next 5–15 years, and as peaking is approached, liquid fuel prices are expected to increase dramatically. This could lead to a crisis in the U.S. transportation system that relies 97% on petroleum, 60% of which is imported.
2. Viable mitigation options for preventing a transportation crisis exist by supplementing and/or replacing liquid fuels derived from petroleum with synthetic fuels from biomass, natural gas, or coal and by reducing demand by increasing the efficiency and mileage of vehicles.
3. For mitigation options to have substantial impact they must be initiated at least 10 yrs before peaking occurs.
4. Plug-in-electric hybrid vehicles are a promising option to reduce the liquid fuel consumption of future transportation vehicles.
5. Plug-in-electric hybrid vehicles can utilize the existing

infrastructure for electric power transmission by charging batteries during off peak hours and use liquid fuels only for a fraction of their overall power needs.

6. Plug-in-electric hybrid vehicles can employ high-efficiency diesel engines that can be fueled by synthetic fuels derived from coal, natural gas, or biomass.
7. Although higher-end use efficiency is essential, increased efficiency alone will not be sufficient to solve the transportation problem without the production of large amounts of synthetic liquid fuels.
8. A number of technologies exist for producing synthetic diesel that can be used in high-efficiency diesel engines and thereby reduce emission of greenhouse-producing gases that lead to global warming.
9. The scale of effort required to provide synthetic fuels will require many years to implement and should therefore be initiated as soon as possible.
10. Plug-in-electric hybrid or all-electric vehicles with available battery technology in an average-sized sedan are economically viable compared to spark-ignition gasoline vehicles.
11. Because of the drastic nature of the impending transportation crisis, it is recommended that market forces be supplemented by government actions, such as incentives for the construction of synthetic fuels plants and CO₂ sequestration, high liquid fuel mileage requirements for automobiles, and support for developing efficient diesel-powered plug-in hybrid vehicles.
12. The scenario proposed in this paper for a secure road transportation system can be instituted immediately with available technologies and without hydrogen or oil.

Acknowledgment

The authors want to thank Joel Mitchell for his contribution as part of an independent study project for the Department of Mechanical Engineering at the University of Colorado.

References

- [1] Hubbert, M. K., 1974, "U.S. Energy Resources: A Review as of 1972: A National Fuels and Energy Policy Study," Serial No. 93-40 (92-75), Part 1, U.S. Government Printing Office, Washington, D.C.
- [2] Kreith, F., West, R. E., and Isler, B., 2002, "Legislative and Technical Perspectives for Advanced Ground Transportation Systems," *Transp. Q.*, **56**(1), pp. 51–73.
- [3] Bartlett, A. A., 2002, "An Analysis of U.S. and World Oil Production Patterns Using Hubbert-Style Curves," *Math. Geol.*, **32**, pp. 1–16.
- [4] www.eia.gov/pub/oil_gas/petroleum/presentations/2000/long_term_supply/se400
- [5] Berry, G. D., and Aceves, S. M., 2005, "The Case for Hydrogen in a Carbon Constrained World," *ASME J. Energy Resour. Technol.*, **127**(2), pp. 89–94.
- [6] Veziroglu, T. N., and Barbir, F., 1992, "Hydrogen: The Wonder Fuel," *Int. J. Hydrogen Energy*, **17**(6), pp. 391–404.
- [7] Kreith, F., and West, R. E., 2004, "Fallacies of A Hydrogen Economy," *ASME J. Energy Resour. Technol.*, **126**, pp. 249–257.
- [8] Hammerschlag, R., and Mazza, P., 2005, "Questioning Hydrogen," *Energy Policy*, **33**, pp. 2039–2043.
- [9] Mazza, P., and Hammerschlag, R., 2004, *Carrying the Energy Future*, Institute for Lifestyle and Environmental Assessment, Seattle, WA.
- [10] Mintz, M., Falga, S., Molburg, S., and Fillette, J., 2002, *Cost of Some Hydrogen Fuel Infrastructure Options*, Argonne National Lab, Argonne, IL.
- [11] Romm, J., Testimony for the Hearing "Reviewing the Hydrogen Fuel and Freedom Car Initiatives," submitted to the House Science Committee, Washington, D.C., March 3.
- [12] <http://www.bts.gov/publications/nationaltransportationstatistics/2003/index.html>
- [13] EPRI, 2004, "Advanced Batteries for Electric Drive Vehicles: A Technology and Cost-Effectiveness Assessment for Battery Electric Vehicles, Power Assist Hybrid Electric Vehicles and Plug-in Hybrid Electric Vehicles," EPRI Tech. Report No. 1009299, EPRI, Palo Alto.
- [14] NRC, 2004, "The Hydrogen Economy: Opportunities, Costs, Barriers and R&D Needs," NRC Report, Washington, D.C.
- [15] CARB, 1994, "1994 Low Emission Vehicle and Zero Emission Vehicle Program Review," Mobile Source Division, Staff Report, California Air Resources Board, Sacramento.
- [16] Kreith, F., Norton, P., Potestio, D., 1995, "Electric Vehicles, Promise and Re-

- ality," *Transp. Q.*, **49**(2), pp. 5–21.
- [17] Sanna, L., 2005, "Driving the Solution—The Plug-in Hybrid Vehicle," EPRI J., Fall.
- [18] Kreith, F., West, R. E., and Isler, B., 2002, "Efficiency of Advanced Varied Ground Transportation Technologies", *ASME J. Energy Resour. Technol.*, **124**, pp. 173–179.
- [19] Stodolsky, F., Gaines, L., Marshall, C. L., An, F., and Eberhardt, J. J., 1999, "Total Fuel Cycle Impacts for Advanced Vehicles," 1999 SAE International Congress and Exposition, Argonne National Laboratories, Argonne, IL, SAE Paper No. 1999-01-0322.
- [20] Parkinson, G., 2005, "Gas-to-Liquid Technology Gains Momentum," *Chem. Eng. Prog.*, **101**, pp. 5–8.
- [21] Williams, R., and Larson, E., 2003, "A Comparison of Direct and Indirect Liquefaction Technologies for Making Fluid Fuels From Coal," *Energy Sustain. Dev.*, **VII**(4), pp. 89–115.
- [22] Mitchell, J., 2004, "Transportation Fuel Made From Coal as an Alternative to Petroleum-Based Fuels," independent study report submitted to the Department of Mechanical Engineering at the University of Colorado, Boulder, Dec.
- [23] Corkadel, C. C., III, 2004, "Rentech Update: FT Fuels Technology for the Future," EFI Gas-to-Market Conference, Washington, D.C., Sept.
- [24] Dept. of Interior, 2003, Final Environmental Impact Statement for the Pettsburg and Midway Coal Mining C. Coal Exchange Proposal, WYW 18816, U.S. Department of Interior, Bureau of Land Management–Wyoming Office, July.
- [25] Greene, M., 2004, "Growing Energy—How Biofuels Can Help End America's Oil Dependence," NRC Report, Washington, D.C., Dec.
- [26] Hammerschlag, R., 2006, "Ethanol's Energy Return on Investment: A Survey of the Literature 1990–Present," *Environ. Sci. Technol.*, **40**, pp. 1744–1750.