

## Adequate model complexity for scenario analysis of VOC stripping in a trickling filter

H. Vanhooren\*, T. Verbrugge\*, G. Boeije\*, D. Demey\*\* and P.A. Vanrolleghem\*

\*BIOMATH department, University of Gent, Coupure Links 653, B-9000 Gent, Belgium

\*\*EPAS N.V., Technologiepark 3, B-9052 Zwijnaarde, Belgium

**Abstract** Two models describing the stripping of volatile organic contaminants (VOCs) in an industrial trickling filter system are developed. The aim of the models is to investigate the effect of different operating conditions (VOC loads and air flow rates) on the efficiency of VOC stripping and the resulting concentrations in the gas and liquid phases. The first model uses the same principles as the steady-state non-equilibrium activated sludge model *SimpleTreat*, in combination with an existing biofilm model. The second model is a simple mass balance based model only incorporating air and liquid and thus neglecting biofilm effects.

In a first approach, the first model was incorporated in a five-layer hydrodynamic model of the trickling filter, using the carrier material design specifications for porosity, water hold-up and specific surface area. A tracer test with lithium was used to validate this approach, and the gas mixing in the filters was studied using continuous CO<sub>2</sub> and O<sub>2</sub> measurements. With the tracer test results, the biodegradation model was adapted, and it became clear that biodegradation and adsorption to solids can be neglected. On this basis, a simple dynamic mass balance model was built. Simulations with this model reveal that changing the air flow rate in the trickling filter system has little effect on the VOC stripping efficiency at steady state. However, immediately after an air flow rate change, quite high flux and concentration peaks of VOCs can be expected. These phenomena are of major importance for the design of an off-gas treatment facility.

**Keywords** Mathematical modelling; off-gas treatment; *SimpleTreat*; stripping; trickling filter; volatile organic contaminants

### Introduction

Industrial wastewater treatment plants have to cope with heavily loaded wastewaters. Often, a considerable part of the chemicals in the wastewater is highly volatile (e.g. solvents). As aeration is a basic process in aerobic biological treatment, there is a big risk for stripping of these volatile organic contaminants (VOCs) together with the air used for aeration (Melcer *et al.*, 1995). The environmental impact of VOCs is high because some of them are toxic, while others contribute to ground-level ozone generation. Most of the studies concerning stripping of VOCs have focused on activated sludge systems. Less is known about their fate in trickling filter systems or other fixed film wastewater treatment plants. Also, stripping is likely to be the most important removal mechanism of volatile components in such systems, as VOC biodegradation is known to be low in systems with short retention times (Dobbs *et al.*, 1989).

In this study, the VOC removal in an industrial wastewater treatment plant was monitored and modelled. The plant under study had a very high loaded influent carrying a considerable amount of volatile components (20 to 30% on a COD basis). The plant consisted of a downflow trickling filter system with forced countercurrent aeration, followed by an activated sludge system. Environmental legislation enforces the construction of an off-gas treatment facility for the trickling filter system. The capital and operating cost and the efficiency of this facility are dependent on the airflow to be treated and the concentration of VOCs. A high removal efficiency of the VOCs – next to biodegradation of non-volatile components – in the trickling filter process is desired, to prevent volatile compounds in the wastewater to wash out to the activated sludge system where they could strip into the open air or hamper the biomass activity.

## Site under study

A scheme of the biofilm wastewater treatment plant under study is depicted in Figure 1. Two trickling filters (TF01 and TF02), each with a height of 6 m and a diameter of 18.5 m, are working in parallel. The total reactor volume is 3160 m<sup>3</sup>. It is filled with a PVC-carrier material of the cross-flow type with a specific surface area of 100 m<sup>2</sup>.m<sup>3</sup> and a porosity of about 95%. There are two recycle loops (long:  $Q^l$  and short:  $Q^s$ ), making sure that every filter constantly receives a recycle flow of 300 m<sup>3</sup>.h<sup>-1</sup>. Both pumping tanks have a volume of 128 m<sup>3</sup>. To provide the biomass in the filters with oxygen, counter-current ventilation is installed with a flow rate of approximately 7800 m<sup>3</sup>.h<sup>-1</sup> for TF01 and 9720 m<sup>3</sup>.h<sup>-1</sup> for TF02. Both ventilators also have a “low position”, providing a flow of 4300 m<sup>3</sup>.h<sup>-1</sup> for TF01 and 6660 m<sup>3</sup>.h<sup>-1</sup> for TF02. These flow rates have been measured accurately using a pitot tube. During the study, the average total influent flow rate was 110 m<sup>3</sup>.h<sup>-1</sup>.

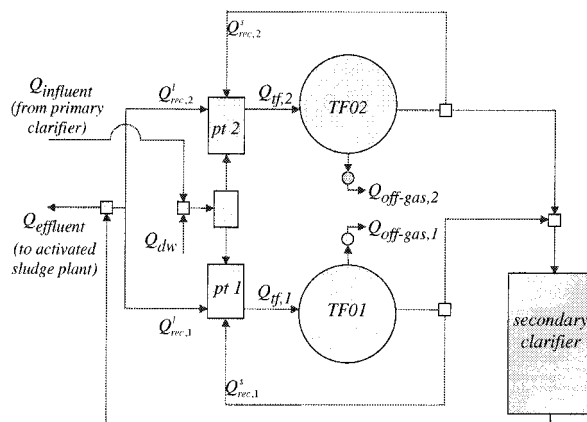
## Measurement techniques

Measurements of the VOC content (in this case mainly dichloromethane, chloroform, toluene and chlorobenzene) of the wastewater were performed in the trickling filter influent and in the short recycle loop of trickling filter TF02 using a purge-and-trap method. Volatile organic compounds are purged out of the wastewater solution with an inert gas (He) to be trapped in a column containing a sorbent (tenax). Detection of the components is then done using gas chromatography and subsequent flame ionisation. The off-gas concentrations of TF02 were measured after adsorption of the VOCs to activated carbon tubes. The same detection method as for the wastewater samples was used.

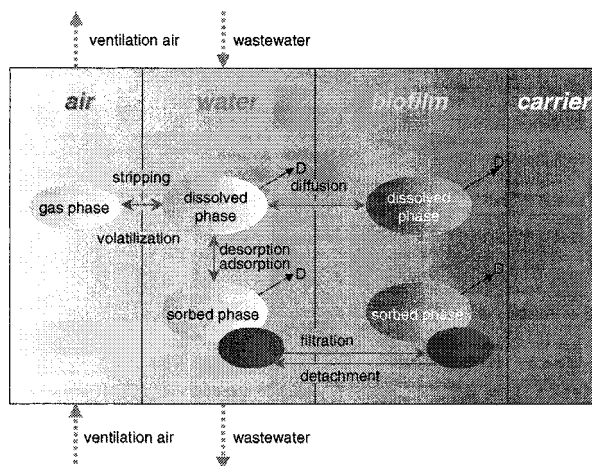
During the same measurement campaign, the off-gas of both filters was continuously analysed for O<sub>2</sub> (paramagnetic) and CO<sub>2</sub> (infrared) using two continuous measurement apparatus (Maihak AG). Together with COD and TOC analyses of the wastewater, these measurements allow us to close the carbon balance and to monitor the stripping and/or biodegradation in the filters and their behaviour under changing process conditions (e.g. changing air flow rates). In this study, the CO<sub>2</sub> and O<sub>2</sub> measurements were also used to model the hydrodynamics of the gas phase of the filters.

## Non-equilibrium steady-state modelling

A model for the fate of individual VOCs was built based on the *SimpleTreat* approach (Boeije, 1999; Struijs, 1996), which is used as a standard in EU environmental risk assessment for activated sludge systems.



**Figure 1** Hydraulic lay-out of the trickling filter system under study (pt = pumping tank, dw = dilution water)



**Figure 2** Overview of the biological and chemical processes in a trickling filter (D = degradation)

### Process description

An overview of biological and chemical processes occurring in a trickling filter is given in Figure 2. Chemicals are present in the dissolved phase and sorbed to suspended solids; the interchange between these phases goes via ad-/desorption. The dissolved chemical can diffuse into the biofilm. Suspended solids with sorbed chemicals may be filtered out of the water; chemicals associated with biofilm solids may be released in the sloughing process. (Bio)degradation may take place inside the biofilm and in the water. Finally, the dissolved chemical may be subject to volatilization and may thus be removed with ventilation air.

### Systems analysis and segmentation

The trickling filter system was subdivided into a number of completely mixed boxes. The first segmentation was between the air above the plant, the filter unit and the settler. The settler was divided further into a dissolved and sorbed phase. The filter itself was split up into five horizontal layers to mimic the plug flow behaviour of such a plant (Boeije, 1999). Each of these layers was subdivided into three compartments: pore air, pore water (dissolved phase) and pore water (sorbed phase). Downward transport of (dissolved and sorbed) chemicals through the filter unit occurs between the pore water of the different layers. By ventilation, pore air is transported upward between the layers. Within a layer, exchange processes take place between air and water (volatilization) and between the sorbed and dissolved phases. To simplify the model, it was assumed that filtration and release (by sloughing) of the sorbed chemical balance each other (resulting in a zero net effect), and chemical sorption equilibria within the biofilm were not considered.

Biodegradation mainly occurs in the biofilm. Continuous chemical diffusion from the pore water into the biofilm is sustained by a concentration gradient due to biodegradation in the biofilm. These coupled processes are dealt with by the steady-state biofilm model of Melcer *et al.* (1995). In this model, the calculated chemical diffusion flux from the pore water into the biofilm is expressed as chemical removal out of the water phase. Hence, the biofilm compartment need not be represented as an extra box.

Next to the between-layer transport, there is also transport of air from the top layer of the filter to the air above the plant, and volatilization from the settler surface. Air flows counter-current through the filter unit (in this case by forced aeration). There is water and solids transport by means of the effluent recycles to the top filter layer. Influent enters the plant into the top filter layer, and effluent, as well as waste sludge, leave the plant via the settler.

**Table 1** VOC-specific model parameters ( $H$ : Henry's law coefficient,  $K_{ow}$ : octanol-water partitioning constant,  $K_b$ : double first order biodegradation rate constant,  $D_f$ : water diffusion coefficient)

VOC	$H_{VOC}^{25^\circ C}$ ( $m^3 \cdot m^{-3}$ )	$\log K_{ow}$ (-)	$K_b$ ( $m^3 \cdot kg^{-1} \cdot h^{-1}$ )	$D_f$ ( $10^{-5} m^2 \cdot d^{-1}$ )
Dichloromethane	0.087 [b]	1.25 [c]	0.77 [d]	8.0 [d]
Choroform	0.146 [b]	1.97 [c]	0.43 [d]	9.2 [d]
Toluene	0.273 [a]	2.69 [c]	1.74 [d]	7.8 [d]
Chlorobenzene	0.157 [a]	2.84 [c]	0.77 [d]	8.0 [d]

[a] Ashworth *et al.* (1988); [b] Gossett (1987); [c] US-EPA (1985); [d] Melcer *et al.* (1995)

**Table 2** Plant-specific model parameters

Plant dimensions		
$A_{TF02}$ [TF02 filter area]	269	$m^2$
$V_{TF02}$ [TF02 filter volume]	1613	$m^3$
$A_{sec}$ [clarifier area]	52	$m^2$
$V_{sec}$ [clarifier volume]	122.5	$m^3$
Flow rates and recycle ratios		
$Q_{inf,2}$ [TF02 influent flow rate]	52.7 [a] / 72.0 [b]	$m^3 \cdot h^{-1}$
$f_{rec,2}^s$ [TF02 short loop recycle ratio]	4.70 [a] / 3.16 [b]	-
$f_{rec,2}^l$ [TF02 long loop recycle ratio]	0	-
$Q_{off-gas,2}$ [TF02 air flow rate]	9720 [a] / 6660 [b]	$m^3 \cdot h^{-1}$
Suspended solids		
$k_{TF02}^{sorption}$ [sorption rate coefficient in TF02 filter]	$19 \cdot 10^{-3}$	$s^{-1}$
$k_{sec}^{sorption}$ [sorption rate coefficient in settler]	$19 \cdot 10^{-4}$	$s^{-1}$
$\rho_{TF02}$ [density of TF02 filter water suspended solids]	1.4	$kg \cdot L^{-1}$
$\rho_{sew}$ [density of sewage (influent) solids]	1.4	$kg \cdot L^{-1}$
$R_{sec}$ [settler suspended solids removal efficiency]	0.01	-
Biofilm and carrier		
$\epsilon$ [filter porosity]	0.95	-
$f_g$ [fraction of filter pores filled with air]	0.05	-
$f_l$ [fraction of filter pores filled with water]	0.05	-
$L$ [stagnant water film thickness]	$10^{-4}$	$m$
$L_f$ [biofilm thickness]	$2 \cdot 10^{-4}$	$m$
$X_f$ [biofilm density]	40.103	$g \cdot m^{-3}$
$a_{b/w}$ [specific biofilm/pore water interfacial area]	100	$m^2 \cdot m^{-3}$
Environmental factors		
$T_g$ [stripping gas temperature]	289.2	K
$h$ [air mixing height]	10	$m$
$v_{wind}$ [wind speed]	4	$m \cdot s^{-1}$

[a] low loading – high air flow [b] high loading – low air flow

## Calculations

Non-trickling filter specific equations were taken as such from *SimpleTreat* version 3.0 (Struijs, 1996). For the calculation of diffusive exchanges, the fugacity approach was applied. Expressions for fugacities, diffusion coefficients and kinetics were taken directly

**Table 3** Influent concentration and removal of chloroform as modelled with the five-layer steady-state model

	Infl.conc. (mg·l <sup>-1</sup> )	% removed via	
		stripping	biodegr.
Low loading – high airflow	62.1	97.1	0.3
High loading – low airflow	148.5	90.1	0.7

from *SimpleTreat*, after Mackay and Paterson (1982). Box volumes in the filter unit were calculated from the number of horizontal layers, the total filter volume and the carrier material's porosity. Volatilization was modeled using the two-layer approach (Treybal, 1980). Surface volatilization in the filter unit occurs at the interface between air and water.

Biodegradation in the dissolved phase of the water compartment is expressed as the sum of two first-order rates: biodegradation by suspended biomass and disappearance of the chemical into the biofilm. In the sorbed phase, only the suspended biomass activity is taken into account. For suspended biodegradation, "double" first-order kinetics (both in active biomass and in chemical concentration) are used. Melcer *et al.* (1995) developed a biofilm model which predicts the mass flux of a chemical from the bulk water into the biofilm per unit of interfacial area and an analytical solution for the chemical mass flux into the biofilm is given. This was converted to a first-order elimination rate coefficient for combined diffusion and biodegradation in one horizontal layer of the trickling filter. In the presented model, the biofilm/water interfacial area has to be known.

### Model calibration

Most of the parameters needed by the model were taken from various literature sources. For the modelling of processes at the biofilm-bulk liquid interface, diffusion coefficients and "double" first-order biodegradation parameters were taken from Melcer *et al.* (1995). Selected parameter values are listed in Table 1 and Table 2. It has to be noted that water diffusion coefficients of low water soluble components are difficult to measure and therefore very rarely stated in literature. Approximation formulas are found in literature, e.g. relating the diffusion coefficient to the inverse of the molecular weight (Perry and Chilton, 1974).

The parameters still to be determined were gas phase and liquid phase mass transfer coefficients for the different VOCs. According to the two resistance theory (Treybal, 1980),  $K_L a$  can be defined as:

$$\frac{1}{K_L a} = \left( \frac{1}{H_{VOC} k_g} + \frac{1}{k_l} \right) \frac{1}{a} \quad (1)$$

where:

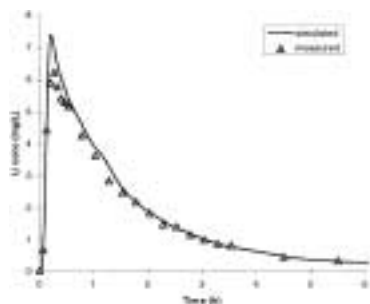
$k_{g/l}$  = mass transfer coefficient for the gas and liquid interphase ( $m \cdot d^{-1}$ )

$a$  = gas-liquid interface surface per unit volume liquid ( $m^2 \cdot m^{-3}$ )

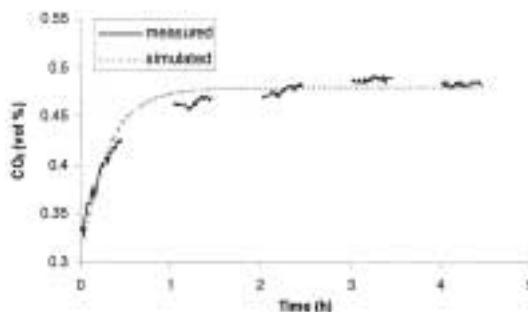
If the liquid film is in turbulent motion, it can be assumed that (De heyder *et al.*, 1997).

$$k_l \propto \sqrt{D_l} \quad (2)$$

Mainly because of the poor knowledge of the liquid diffusion coefficient of the VOCs under study, it was decided to use the same value for the mass transfer coefficients for all four components. These values were  $86.4 m \cdot d^{-3}$  for  $k_g$  and  $0.0864 m \cdot d^{-3}$  for  $k_l$ . These values were based on estimations by Parker *et al.* (1996). This resulted in an almost constant value for the total mass transfer coefficient  $K_L$  of  $0.085 m \cdot d^{-1}$  ( $K_L a = 8.5 d^{-1}$ ), where the very small changes are only due to the different Henry constant for the four VOCs.



**Figure 3** Comparison between model performance and measured lithium concentration in the short recycle stream



**Figure 4** Comparison between simulated and measured  $\text{CO}_2$  concentration in the off-gas of TF02 after lowering the air flow rate at time 0

To test the model, six measurements for VOCs in the liquid and the gas phase of filter TF02 were done under high air flow rate conditions, and four measurements were done under low air flow rate conditions. The results were averaged to minimise the effect of measurement errors. It is noteworthy that the VOC loading was quite different before compared to after the air flow change. After the lowering of the air flow rate, the load (influent flow as well as influent concentration) increased considerably.

The simulation results were very good as far as the concentrations in the off-gas are concerned. The model predictions deviated only  $5.0 (\pm 3.0)\%$  from the measured data for the different individual VOCs. The simulated effluent concentrations, on the other hand were less accurate. In the low loading – high airflow case, the deviation was  $37.7 (\pm 36.3)\%$ , and in the high loading – low airflow case, the deviation amounted  $89.2 (\pm 58.1)\%$ . These high deviations are however acceptable because in all cases, more than 90% of the volatile contaminant is stripped (Table 3). This means that the effluent concentrations were very low compared to the influent VOC-concentrations, so small measurement errors have a considerable effect. Indeed, comparing liquid phase and gas phase VOC concentrations should be done with care, due to the different sampling and measurement methods.

## Hydrodynamics of the filter system

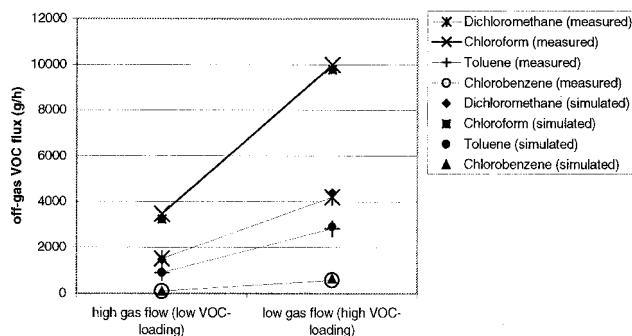
### Hydrodynamic behaviour of the liquid phase

In the original model, the number of horizontal layers was five. It was assumed this was necessary to accurately model the plug-flow behaviour in the trickling filter. To validate this assumption, a tracer test was conducted (De Clercq *et al.*, 1999). The tracer, 5 kg of LiCl, was injected as a pulse in the pumping tank. The measurement of the concentration was performed in the short recycle flow and in the effluent of the pumping tank (Figure 1). The hydraulics of the pumping tank could be adequately described by two tanks in series. Physically, it can be assumed that they correspond with the volumes before and after the baffle in the tank. Next to this, a considerable dead volume (42% of the tank volume) was found.

Once the concentration profile in the pumping tank could be simulated (serving as the influent for the filter), it was possible to study the hydraulic behaviour of the trickling filter itself. It was found that the free flowing liquid in the filter could be described as a two tanks-in-series system with two tanks of  $15 \text{ m}^3$  each (Figure 3, note the “bumps” resulting from the recycled tracer).

### Gas mixing in the trickling filters

The gas mixing in the trickling filter system could be studied, when the ventilators were switched from “high” to “low” position. The short term response provided information on the mixing properties of the gas phase inside the reactor. The results show that the gas phase



**Figure 5** Result of the calibration of the VOC flux in the off-gas of TF02 with a  $K_L a$  of  $50 \text{ d}^{-1}$

could be modelled as a single perfectly mixed tank. The measured values of the air flow rate were implemented, together with a constant production rate of  $\text{CO}_2$  and a constant consumption rate of  $\text{O}_2$ . As was shown in Vanhooren *et al.* (2000), this assumption could be made because the wastewater composition did not change significantly during the short period around the step change in air flow rate and because the biodegradation was not affected by the air flow rate change (at least not within the ranges of air flows used in this study). The volume of the single perfectly mixed tank was  $2000 \text{ m}^3$ . This volume was larger than the actual volume of the filter bed, but the head space above the bed must be considered too. The result of the simulations – no calibration was needed – can be seen on Figure 4. As an example the measured and simulated  $\text{CO}_2$  concentrations are depicted.

### Model reduction

As shown above, two tanks in series were enough to model the hydraulic behaviour of the trickling filter. The number of layers in the original model could thus be reduced to two. Also, in the original model, the total water volume in the filter was estimated to be  $80 \text{ m}^3$  per filter, based on the carrier material characteristics. The tracer test showed this volume was only  $30 \text{ m}^3$ . After the adaptation of the steady-state model, the calibration needed to be repeated, and a  $K_L a$  of  $50 \text{ d}^{-1}$  was suited to obtain similar good simulation results. The deviation between modelled and simulated off-gas concentrations was now  $5.8 (\pm 4.8)\%$ . The average deviation from the measured effluent concentrations for both high and low air flow was  $28 (\pm 28.5)\%$ . Some simulation results can be seen on Figure 5. On this figure the measured and simulated VOC flux in the gas phase is depicted. Note that the result was good for high as well as for low flow. As mentioned above, the same mass transfer coefficient  $K_L a$  was used for high as well as for low flow. Apparently, the mass transfer coefficient was independent of the applied air flow rate. Indeed, in the range of air flows applied, a change of the interfacial area between liquid and gas phase was not to be expected. In the literature it is shown that the interfacial area is the most sensitive parameter for the mass transfer in trickle flow reactors (Illiota *et al.*, 1997).

From Table 3 it becomes clear that the model predicted only very little biodegradation for these very volatile components. The model can thus further be simplified by neglecting the biodegradation term in the model formulation. Also the amount of VOCs adsorbed to suspended biomass was negligible. Neglecting these terms in the model formulation in fact simplified the model to a simple mass balance model that can be reformulated dynamical very easily. This dynamical model was then used for scenario analysis.

Here again, the gas phase in filter TF02 was modelled as a single ideally mixed tank of  $2000 \text{ m}^3$ , while the water phase inside the filter was modelled as two ideally mixed tanks (tank *a* and *b*) in series of  $15 \text{ m}^3$  each. A mass balance over the gas phase yields:

$$\frac{dC_{off-gas}}{dt} = \frac{Q_{off-gas}}{V_{gas-phase}} (C_{ambient-air} - C_{off-gas}) + N_{s,a} + N_{s,b} \quad (3)$$

where:

$N_{s,a/b}$  = flux of VOC due to stripping from the liquid phase to the gas phase ( $\text{g} \cdot \text{m}^{-3} \cdot \text{d}^{-1}$ )

$$\begin{cases} \frac{dC_{liquid,a}}{dt} = \frac{Q_{rf}}{V_{liquid-phase,a}} (C_{l,pt} - C_{liquid,a}) - N_{s,a} \\ \frac{dC_{liquid,b}}{dt} = \frac{Q_{rf}}{V_{liquid-phase,b}} (C_{liquid,a} - C_{liquid,b}) - N_{s,b} \end{cases} \quad (4)$$

The flux from liquid to gas phase was modelled as follows (for both tanks 1 and 2):

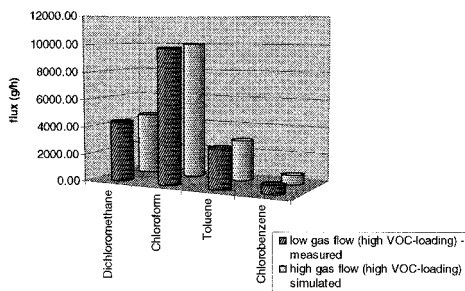
$$N_{s,a/b} = K_L a \left( C_{liquid,a/b} - \frac{C_{off-gas}}{H_{VOC}} \right) \quad (5)$$

### Scenario analysis

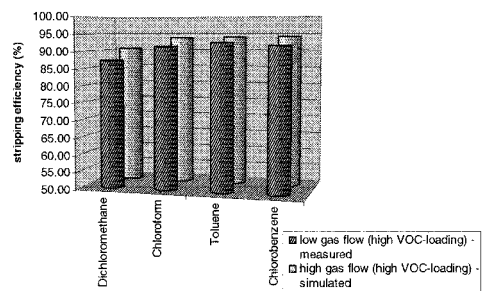
After model reduction and calibration for high loading – low air flow and low loading – high air flow, simulations were done to predict the effect of a third situation, namely a high loading of VOCs in the influent together with a high air flow rate. This situation was compared with the high loading – low air flow case. The question to be answered was whether the stripping efficiency would be higher with a high flow and what effect this would have on the VOC concentrations in the off-gas and the effluent.

The simulation results are shown on Figure 6 and Figure 7. A small increase of the VOC flux and the stripping efficiency was noticed when high air flow was compared to the low air flow case. A high air flow rate resulted in a larger driving force for stripping because of the higher concentration gradient at the gas-liquid interface. On the other hand, a high flow rate also means a lower gas residence time. The combination of these two effects diminished the effect to only a few percentages in removal efficiency and slightly lower effluent concentrations at the high flow rate. The air flow rate can thus be lowered without incurring a considerable effect on the stripping efficiency, but it will obviously result in higher concentrations in the air to be treated by the off-gas treatment facility.

At the industrial wastewater treatment plant under study an overall waste gas management strategy is to be implemented over the next year. Waste gasses are coming from the equalisation system, the trickling filters and the sludge treatment. The waste gas flow rate coming from the sludge treatment (filter presses) is not constant because of batch-wise ventilation during day-time. Four times a day, the presses have to be opened during 30 minutes

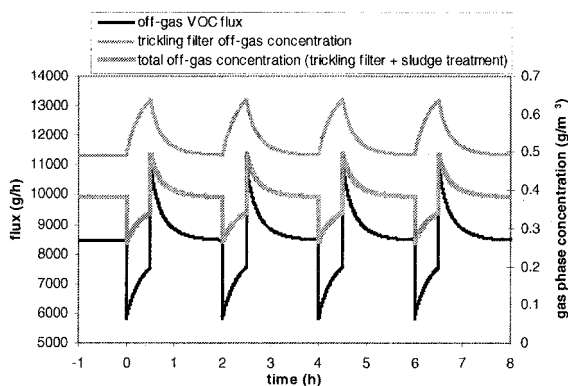


**Figure 6** Effect of two different air flow rates on the VOC flux in the off-gas at high VOC loading



**Figure 7** Effect of two different air flow rates on the VOC removal efficiency in the off-gas at high VOC loading





**Figure 8** Effect of an air flow change (low to high air flow) with a constant wastewater composition on the flux and the off-gas concentration of chloroform at the trickling filters and the VOC treatment facility

for cleaning. During these periods, the air flow coming from the presses hall increases from 2200 m<sup>3</sup>/h to 7600 m<sup>3</sup>/h. The VOC loading of these off-gasses can be neglected. To keep the flow rate in the off-gas treatment facility constant (which is necessary for its operation), the flow over the two trickling filters could be temporarily lowered during these periods. It is therefore important to know what effect these gas flow rate changes will have on the concentration and the total load of the VOCs in the off-gas treatment facility.

Dynamic simulations were performed to predict the flux and concentration profiles immediately after an air flow change. The results for chloroform are shown in Figure 8. At time 0, the air flow through the filters is decreased for 30 minutes to allow the waste gas treatment to cope with the high air flow coming from the sludge treatment. In this period, the concentration in the trickling filters off-gas increases as seen above. The increase of the flow rate after this 30 minute period therefore results in a quite high flux peak of chloroform to the VOC treatment facility. The chloroform concentration in the trickling filter off-gas immediately starts to drop during high flow periods. These are factors certainly to be taken care of when designing the off-gas treatment facility.

## Conclusions

Two mathematical models describing the stripping of VOCs in an industrial wastewater treatment plant were developed. The first model was based on the steady-state non equilibrium model *SimpleTreat* combined with a biofilm degradation model of Melcer *et al.* (1995). The second model was a simple dynamic mass balance model, built on the basis of the results of simulations with the biodegradation model and of a tracer test. The simulations showed that biodegradation as well as adsorption to suspended solids can be neglected for the volatile organics under study. The results of the tracer test with LiCl could adequately be described with a two tanks-in-series model. The hydrodynamic description of the original model (five layers in the trickling filter) could thus be simplified down to a two-layer model. The gas mixing inside the filter could be described by a single perfectly mixed tank with the actual gas volume of the reactor. The validity of this description was proven by continuous CO<sub>2</sub> and O<sub>2</sub> measurements in the gas phase of the filters. Scenario analyses with the simplified model showed that stripping was virtually independent of the applied air flow rate. At high air flow, the total stripping efficiency only increased with a few percentages, resulting in a lower gas phase VOC concentration. Dynamic simulations, however, revealed that immediately after changes in air flow rate, quite high flux and concentration peaks are to be expected. This should be considered when designing an off-gas treatment facility.

## Acknowledgement

Financial support for this work was provided by the Flemish Institute for the Promotion of Scientific-Technological Research in Industry (IWT). The first author is Research Assistant of the Fund for Scientific Research – Flanders (Belgium). The authors thank KELMA bvba (Niel, Belgium) for setting the off-gas measurement equipment at our disposal.

## References

- Ashworth, R.A., Howe, G.B., Mullins, M.E. and Rogers, T.N. (1988). Air-water partitioning coefficients of organics in dilute aqueous solutions. *Journal of Hazardous Materials*, **18**, 25–36.
- Boeije, G. (1999). Chemical fate prediction for use in geo-referenced environmental exposure assessment. PhD thesis, Faculty of Agricultural and Applied Biological Sciences, University Gent.
- De Clercq, B., Coen, F., Vanderhaegen, B. and Vanrolleghem, P.A. (1999). Calibrating simple models for mixing and flow propagation in waste water treatment plants. *Wat. Sci. Tech.*, **39**(4), 61–69.
- De heyder, B., Vanrolleghem, P.A., Van Langenhove, H. and Verstraete, W. (1997). Kinetic characterisation of microbial degradation of low water soluble gaseous compounds in batch experiments under mass transfer limited conditions. *Biotechnol. Bioeng.*, **55**, 511–519.
- Dobbs, R.A., Wang, L. and Govind, R. (1989). Sorption of toxic organic compounds on wastewater solids: correlation with fundamental properties. *Environ. Sci. Tech.*, **23**, 1092–1097.
- Gossett J.M. (1987). Measurement of Henry's law constants for C<sub>1</sub> and C<sub>2</sub> chlorinated hydrocarbons. *Environ. Sci. Tech.*, **21**, 202–208.
- Iliuta, I., Iliuta, M.C. and Thyriou, F.C. (1997). Gas-liquid mass transfer in trickle-bed reactors: gas-side mass transfer. *Chem. Eng. Technol.*, **20**, 589–595.
- Mackay, D. and Paterson, S. (1982). Fugacity revisited. *Environ. Sci. Tech.*, **16**, 654–660.
- Melcer, H., Parker, W.J. and Rittmann, B.E. (1995). Modeling of volatile organic contaminants in trickling filter systems. *Wat. Sci. Tech.*, **31**(1), 95–104.
- Parker, W.J., Montheith, H.D. and Melcer, H. (1996). VOCs in fixed film processes. II: Model studies. *J. Env. Eng.*, **122**, 564–570.
- Perry, R.H. and Chilton, C.H. (1974). *Chemical Engineers's Handbook*. London, McGraw-Hill.
- Struijs, J. (1996). *SimpleTreat 3.0: a model to predict the distribution and elimination of chemicals by sewage treatment plants*. Report nr. 719101025. National Institute of Public Health and Environmental Protection (RIVM), Bilthoven, The Netherlands.
- Trybal, R.E. (1980). *Mass Transfer Operations*. New York, McGraw-Hill.
- US-EPA (1985). *Rates, Constants and Kinetics Formulations in Surface Water Quality Modeling*. 2nd edn. Athens, Georgia, United States EPA.