

## Development of two-dimensional water quality management model using the reliability analysis method

Sang-Ho Kim, Kun-Yeun Han, Ji-Sung Kim and Joonwoo Noh

### ABSTRACT

A two-dimensional water quality management model, the unsteady/uncertainty water quality model (UUWQM), is developed for three kinds of analysis: hydrodynamic and advection–diffusion analyses by using the Petrov–Galerkin finite element method, and a reliability analysis by using uncertainty techniques. This model is then applied to a 35 km reach of the Nakdong River in Korea. Two-dimensional hydrodynamic and deterministic water quality analyses were performed in this reach. The Monte Carlo simulation (MCS) method was used to decide and verify 14 key input parameters among 80 total input parameters. These key input parameters were incorporated to compute exceedance probabilities and frequency distributions using the mean first-order second-moment (MFOSM) and MCS methods at several locations along this reach of the Nakdong River. From the results of the probable risk for water quality standard, it shows that the outputs from the MFOSM method were similar to those from the MCS method. In practical usage, the MFOSM method is more attractive in terms of its computational simplicity and shorter execution time. Therefore, the UUWQM can be applied efficiently and accurately to estimate the water quality distribution and the risk assessment for the specified water quality in any river.

**Key words** | finite element, reliability analysis, uncertainty, water quality model

#### Sang-Ho Kim

Department of Civil Engineering,  
Sangji University,  
Wonju, 83 Sangjidae-Gil Wonju 220-708,  
Korea

#### Kun-Yeun Han

Department of Civil Engineering,  
Kyungpook National University,  
Daegu, 80 Daehak-Ro Daegu 702-701,  
Korea

#### Ji-Sung Kim

River and Coastal Research Division,  
Korea Institute of Construction Technology, 1190  
Simindae-Ro Goyang 411-712,  
Korea

#### Joonwoo Noh (corresponding author)

River Environment Team,  
K-water Research Institute,  
Daejeon, 462-1 Jeonmin-Dong Daejeon 305-730,  
Korea  
E-mail: [jnoh@kwater.or.kr](mailto:jnoh@kwater.or.kr)

### INTRODUCTION

There are various water quality models of rivers, from a fairly simple analytical model through an elaborate unsteady flow model. Most variation in water quality in a river occurs along the longitudinal direction. Therefore, a one-dimensional model, which has an average value for a section, is generally used. The one-dimensional model can be applied to most river systems; however, a one-dimensional analysis cannot fully simulate the dispersion effect occurring around a pollutant outlet such as the wastewater inflow discharged into a watershed or at a junction of two rivers. Such cases require us to apply a more detailed model.

A three-dimensional model of an unsteady state is required to numerically simulate a pollutant-mixing phenomenon in a river. However, the development of this model's structure is very complicated and it takes considerable time and effort to apply. Generally, rapid mixing in the vertical direction results in less flow variation than in the

longitudinal or transversal directions. Therefore, natural phenomena can be more easily simulated with a two-dimensional depth-averaged model. A two-dimensional shallow-water equation and an advection–diffusion equation have to be solved to get the numerical solution for water flow and water quality in a river.

Three numerical techniques, the finite difference method (FDM), the finite element method (FEM) and the finite volume method (FVM), have been suggested to solve these equations. Lee & Froehlich (1986) noted that FDM requires more nodes and computational time to achieve an accuracy compared to FEM. Zhao *et al.* (1994) described the limits of the FDM in simulating flow in an unstructured grid in natural water bodies and the limits of the FVM in simulating domains having discontinuities and shocks. The FEM is attractive for simulating water flow in a river having irregular boundaries and complex topography. The

flexibility of the FEM allows one to choose from a wide array of linear and higher-order elements, which can then be combined to give the best representation of complex domains using an unstructured grid. An investigation showed that FEM results usually require fewer nodes than the FDM and FVM to achieve similar accuracy and consistency (Ghanem 1995). Gray & Van Genuchten (1978), Kinnmark & Gray (1982) and Hughes & Brooks (1982) applied the Galerkin technique to analyze an advection–diffusion equation.

The parameters used in most models, including a two-dimensional water quality model, present us with a range of values representing the natural phenomena of a river. However, we cannot use the entire range of values in each parameter. Therefore, we need to choose a deterministic value to represent each parameter. Yet, because the mechanism of water quality reactions is complicated in structure, it is difficult to identify and apply the parameters with a deterministic value.

Therefore, the reliability analysis has to be applied to evaluate the sensitivity and quantify the uncertainty of water quality parameters in a model. The most important aspect of applying reliability-analysis methods such as first-order reliability analysis (FORA) and Monte Carlo simulation (MCS) for the assessment of model-prediction uncertainty is to characterize properly the uncertainty in the individual basic variables (Melching & Yoon 1996). Burges & Lettenmaier (1975), Chadderton *et al.* (1982), Tung & Hathhorn (1988) and Melching & Anmangandla (1992) applied the FORA method to the Streeter–Phelps equation and estimated uncertainties using a statistical analysis. Zou *et al.* (2002) suggested a neural-network-embedded Monte Carlo (NNMC) approach to account for uncertainty in water quality modeling. Mailhot & Villeneuve (2003) proposed first-order second-moment (FOSM) methods to estimate uncertainties on model results based on given uncertainties of model parameters. Ghosh & Mujumdar (2006) applied an uncertainty analysis to evaluate the fuzzy risk of low water quality. More recently, the GLUE (generalized likelihood uncertainty estimation) methodology (Lindblom *et al.* 2007; Thorndahl *et al.* 2008; Freni *et al.* 2009a, b) and MCMC (Monte Carlo Markov chain) methods (Kleidorfer *et al.* 2009; Dotto *et al.* 2010) were proposed and applied to the uncertainty analysis of water quality modeling.

These approaches have the advantage in conducting stochastic calibration and uncertainty analysis simultaneously.

In this study, a water quality management model is designed and tested to advance the state of science and engineering in hydrodynamics and water quality control problems in the Nakdong River. The proposed unsteady/uncertainty water quality model (UUWQM) is a two-dimensional river flow and water quality computational model, which is composed of a hydrodynamic analysis component, a contaminant transport analysis component, a reliability analysis component and a Windows-based graphic user interface (GUI) component. A two-dimensional Petrov–Galerkin finite element method is used for both flow and advection–diffusion computations. A mean-value first-order second-moment (MFOSM) method and MCS are used for the reliability analysis and for quantifying the model and input uncertainties on the water quality control system.

The next section presents the basic concept of the finite element method for the advection–diffusion analysis and the MFOSM and MCS methods for the reliability analysis. These are followed by a description of the proposed model structure and the study area. Finally, the results of a deterministic and a stochastic analysis of water quality conditions using the proposed model are presented.

---

## DEVELOPMENT OF THE UNSTEADY/UNCERTAINTY WATER QUALITY MODEL

The UUWQM proposed in this study is composed of a deterministic two-dimensional water quality simulation model and an uncertainty and reliability analysis model. The deterministic water quality simulation model contains a hydrodynamic analysis model and a contaminant transport model. The governing equation of the deterministic water quality simulation model was solved using the finite element method.

### Deterministic 2D water quality simulation model

Prior to the water quality simulation, the hydrodynamic analysis is a prerequisite. In this study the two-dimensional depth-averaged shallow water equation was solved for hydrodynamic analysis.

The continuity equation is

$$\frac{\partial h}{\partial t} + \frac{\partial p}{\partial x} + \frac{\partial q}{\partial y} = 0 \quad (1)$$

and the momentum equations are

$$\frac{\partial p}{\partial t} + \frac{\partial}{\partial x} \left( \frac{p^2}{h} + \frac{gh^2}{2} \right) + \frac{\partial}{\partial y} \left( \frac{pq}{h} \right) + gh \frac{\partial z_0}{\partial x} + gn^2 \frac{p(p^2 + q^2)^{1/2}}{h^{7/3}} = 0 \quad (2)$$

$$\frac{\partial q}{\partial t} + \frac{\partial}{\partial y} \left( \frac{q^2}{h} + \frac{gh^2}{2} \right) + \frac{\partial}{\partial x} \left( \frac{pq}{h} \right) + gh \frac{\partial z_0}{\partial y} + gn^2 \frac{q(p^2 + q^2)^{1/2}}{h^{7/3}} = 0 \quad (3)$$

in which  $p$  and  $q$  = flow rate per unit width in the  $x$  and  $y$  directions;  $h$  = depth of water;  $t$  = time;  $g$  = gravity;  $z_0$  = bed elevation and  $n$  = the Manning roughness coefficient.

Katopodes (1984) applied the Petrov–Galerkin scheme for two-dimensional hydrodynamic analysis. Considering wave celerity in selection of the weighting function, it allows a more stable and accurate hydrodynamic analysis, especially in the discontinuous channel flow such as surges and shocks.

By applying the Petrov–Galerkin FEM, this study developed a water quality simulation model linked with the results of hydrodynamic analysis. The governing equation to simulate contaminant transport can be written as follows:

$$\frac{\partial(hC)}{\partial t} + \frac{\partial(pC)}{\partial x} + \frac{\partial(qC)}{\partial y} - \frac{\partial}{\partial x} \left[ h \left( E_{xx} \frac{\partial C}{\partial x} + E_{xy} \frac{\partial C}{\partial y} \right) \right] - \frac{\partial}{\partial y} \left[ h \left( E_{yx} \frac{\partial C}{\partial x} + E_{yy} \frac{\partial C}{\partial y} \right) \right] + R = 0 \quad (4)$$

in which  $C$  = depth-averaged concentration of an arbitrary species;  $E_{xx}$ ,  $E_{xy}$ ,  $E_{yx}$  and  $E_{yy}$  = components of the dispersion tensor and  $R$  = source or sink term for a pollutant.

### Petrov–Galerkin finite element formulation

Equation (4) can be used to simulate a contaminant transport that is well mixed over the vertical direction (Fischer

et al. 1979). The Petrov–Galerkin approximation over a single element yields

$$\int_{\Omega} N_*^T \left\{ \frac{\partial(hC)}{\partial t} + \frac{\partial(pC)}{\partial x} + \frac{\partial(qC)}{\partial y} - \frac{\partial}{\partial x} \left[ h \left( E_{xx} \frac{\partial C}{\partial x} + E_{xy} \frac{\partial C}{\partial y} \right) \right] - \frac{\partial}{\partial y} \left[ h \left( E_{yx} \frac{\partial C}{\partial x} + E_{yy} \frac{\partial C}{\partial y} \right) \right] + R \right\} d\Omega \quad (5)$$

The associated weighting function is defined by (Piasecki & Katopodes 1999)

$$N_* = N + \frac{|p|\Delta x + |q|\Delta y}{\sqrt{15(p^2 + q^2)}} \left( p \frac{\partial N}{\partial x} + q \frac{\partial N}{\partial y} \right) \quad (6)$$

where  $N$  = vector of bilinear shape functions,

$$\Delta x = 2 \left[ \left( \frac{\partial x}{\partial \xi} \right)^2 + \left( \frac{\partial x}{\partial \eta} \right)^2 \right]^{1/2},$$

$$\Delta y = 2 \left[ \left( \frac{\partial y}{\partial \xi} \right)^2 + \left( \frac{\partial y}{\partial \eta} \right)^2 \right]^{1/2},$$

and  $\xi$  and  $\eta$  = local coordinates converted from global coordinates. A hydrodynamic reaction is represented by  $R$  of Equation (4) that includes both the growth/decay and the source/sink terms:

$$R = -hGC - hS \quad (7)$$

where  $h$  = depth,  $C$  = concentration of pollutant,  $G$  = the rate of growth/decay of water quality variables and  $S$  = the rate of source/sink of water quality variables caused by interaction with other variables. Table 1 shows water quality variables that could be controlled in this study model. The interaction of water quality variables, such as the circulation of nutrients like nitrogen and phosphorus, the growth of algae and sediment oxygen demand, can be simulated using this model.

### Main features of the UUWQM

The UUWQM is developed to simulate a hydrodynamic and a contaminant transport. The UUWQM can be

**Table 1** | Controllable water quality variables

Water quality constituents		
Temperature	Dissolved oxygen (DO)	Biochemical oxygen demand (BOD)
Organic nitrogen (Org-N)	Ammonia nitrogen (NH <sub>3</sub> -N)	Nitrite nitrogen (NO <sub>2</sub> -N)
Nitrate nitrogen (NO <sub>3</sub> -N)	Organic phosphorus (Org-P)	Dissolved phosphorus (PO <sub>4</sub> -P)
Algae	Coliform	Arbitrary non-conservative

controlled for a water quality analysis with unsteady state, a two-dimensional DO-BOD analysis in a river and an eutrophication analysis considering the effects of nitrogen and phosphorus. The reliability analysis that considers the uncertainty of input parameters in a model could also be

applied with the UUWQM. From the reliability analysis, the UUWQM can suggest probabilistic results. Figure 1 shows the structure of the UUWQM, which can be applied to a deterministic water quality analysis and a reliability analysis. As shown in the figure, the model is composed of one main program and 39 subroutines. The UUWQM has the following tools to be used as a water quality management system:

- steady- and unsteady-state tool,
- boundary tool including point loads,
- geological and meteorological data control tool,
- graphical output tool using the GUI,
- sensitivity and uncertainty analysis tool for input parameters, and
- reliability analysis tool for water quality target values.

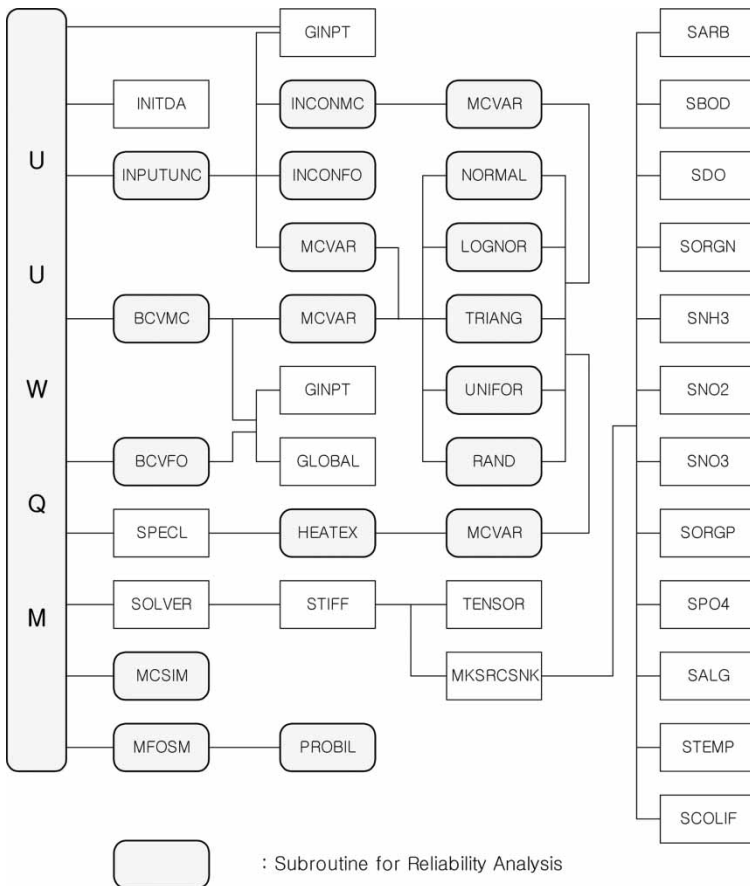

**Figure 1** | Schematic of the UUWQM.

## UNCERTAINTY AND RELIABILITY ANALYSIS

In general, the uncertainty in modeling a physical system may arise from one or more of the following: (i) insufficient knowledge of the laws of nature describing the system; (ii) computational inadequacy to accurately assess the outcome of experiments; (iii) inability to precisely replicate an experiment or insufficient knowledge of system inputs or boundary conditions, and (iv) the inherent random nature of the process (Giri *et al.* 2001). Therefore, a process to consider uncertain versus deterministic parameters is needed. Reliability analysis is able to estimate the probability of risk for output variables when uncertainties of input parameters are known. The two-dimensional UUWQM developed in this study performs uncertainty analysis using the MFOSM and MCS method, and then reliability analysis based on the results of the uncertainty analysis. This reliability analysis can simulate probabilistic results for water quality analysis in a river.

### MFOSM method

A reliability analysis using the first-order second-moment (FOSM) method was traditionally used to analyze the safety of structures. Tang & Yen (1972) have since applied it to estimate the risk for a hydraulic system. The theory of the FOSM is based on a Taylor series expansion. A Taylor series expansion for  $Y = G(x_i)$  at  $P(x_{1p}, x_{2p}, x_{3p}, \dots, x_{np})$  is described as follows:

$$Y = G(x_{1p}, x_{2p}, x_{3p}, \dots, x_{np}) + \sum_{i=1}^n (x_i - x_{ip}) \left( \frac{\partial G}{\partial X_i} \right)_p + \frac{1}{2} \sum_{i=1}^n \sum_{j=1}^n (x_i - x_{ip})(x_j - x_{jp}) \left( \frac{\partial^2 G}{\partial X_i \partial X_j} \right)_p + \text{higher order terms} \quad (8)$$

where the subscript  $p$  indicates the expansion will be applied at point  $p$ . The first-order approximation of a Taylor series expansion is formulated by a truncation of terms higher than second order in Equation (8). If a Taylor series is expanded with respect to the mean of the variables,  $X_m(x_{m1}, x_{m2}, x_{m3}, \dots, x_{mn})$ , the expected value and variance for unrelated variables can be represented

as follows:

$$E(Y) = G(x_{m1}, x_{m2}, x_{m3}, \dots, x_{mn}) \quad (9)$$

$$\text{Var}(Y) = \sum_{i=1}^n \text{Var}(X_i) \left( \frac{\partial G}{\partial X_i} \right)_m^2 \quad (10)$$

Because the first approximation contains two moments, mean and variation, of uncertain parameters that are expanded at the mean value, this approach is called the mean first-order second-moment (MFOSM) method. In practical aspects, it is more desirable and efficient to treat the dependent variables separately in a different procedure as if they are independent variables (Yoon 1994).

### Monte Carlo simulation

MCS is a means for numerically operating and repeating a complex system that has a set of random input parameters. Input parameters are sampled at random from pre-determined probability distributions with or without correlation. A type of probability distribution is identified or assumed for each uncertain characteristic in a model. The MCS method is not restricted to any particular distribution. By repeating the process, a set of results of output variables for each corresponding set of random input parameters is obtained. These results are similar to a set of results from experimental observations. Therefore, the results of the MCS may be treated statistically and methods of statistical estimation and inference are applicable (Ang & Tang 1984).

In this study, multiplicative congruential generators (MCGs) were used to generate random numbers for the MCS. MCGs take the following forms (Park & Miller 1988):

$$X_{i+1} = aX_i \pmod{m} \quad (11)$$

$$U_i = X_i/m \quad (12)$$

where  $a$  is a multiplier,  $m$  is the modulus,  $X_i$  is an initial value to generate random numbers and  $U_i$  is a uniform

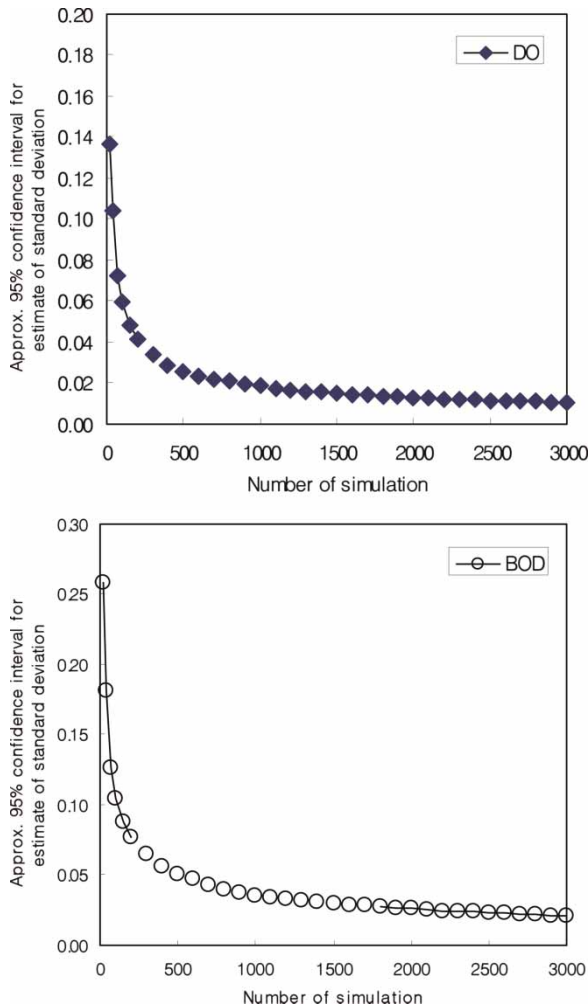

Figure 2 | Convergence characteristic of the Monte Carlo simulation.

random number between 0 and 1. In order to choose the number of simulations to use, escalating numbers of simulations, up to 3,000, were considered. As shown in Figure 2, 1,000 simulations were required to achieve estimates of output standard deviations of DO and BOD within about 5% of the average standard deviation with 95% confidence. Therefore, 1,000 simulations were used in this study.

### Reliability analysis

Reliability is defined as the probabilistic measure of whether a system meets certain standards, and can be described as a problem of load (simulated constituent concentrations) and resistance (water quality standards).

This study is focused on the violating probability of a given load versus a given resistance. Therefore, the reliability analysis is expressed in terms of exceedance probability. In general, the exceedance probability means the risk of computed concentrations of any output variable, except for DO, exceeding an existing standard. In contrast to the variables, the risk for DO represents the probability that the computed results will be less than a given standard. The risk using the MCS method can be represented as (Tung & Yen 2005):

$$P_e = \frac{\text{Number of occurrences for } Z < 0 \text{ (or } R < L)}{\text{Number of total simulations}} \quad (13)$$

where  $Z = R - L$ ;  $R$  = a given standard concentration and  $L$  = the simulated concentration. The risk using the MFOSM method is represented as

$$P_e = \Phi(-\beta) = 1 - \Phi(\beta) \quad (14)$$

$$\beta = \frac{E[R - \mu_0]}{\sigma_0} \quad (15)$$

where  $E[\ ]$  = the expectation;  $\mu_0$  and  $\sigma_0$  = the estimated mean and standard deviation of the output variables, respectively; and  $\Phi$  = the cumulative distribution function of the standard normal distribution.

### APPLICATION

The selected site is the 35.04 km main reach of the Nakdong River from Sengju to Hyunpoong in South Korea. This reach contains the polluted Keumho tributary and some water supply intake plants. The Nakdong River supplies an especially large quantity of water to the metropolitan areas that lie along its route. Therefore, the water quality of the Nakdong River has been an important issue.

### Establishment of topographical data

Three-dimensional topographical data were constructed according to the rules of making digital maps by vectorizing the base maps of the research area, which consisted

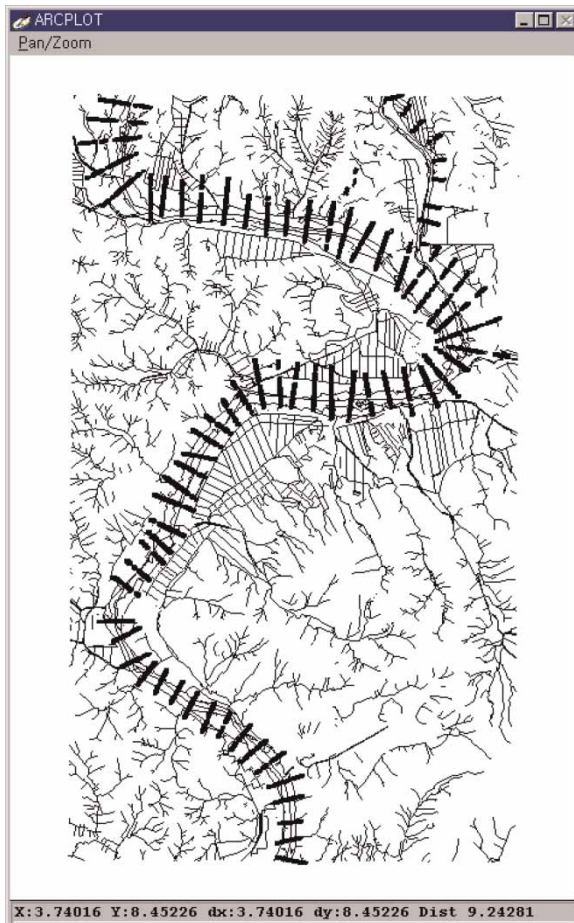

Figure 3 | The points of cross section data along the channel.

of 1/5,000-scale topographical maps. After vectorizing the base maps and combining the developed coverages to construct the topographical data, HEC-2 input data from the River Management Plan of the Nakdong River was added to reflect the topography of a surveyed channel as shown in Figure 3. A triangulated irregular network (TIN) was developed using the topographical data and the surveyed channel data. The resulting watershed-basin map can be displayed with a grid format of the research basin in the ArcView program using the TIN.

### Hydraulic and water quality analysis

A water-flowing simulation has to be performed in advance to simulate a variation of water quality in a river. A mesh was made up to represent a main channel during the mean

flow season and the hydrodynamic analysis of the discharge during the mean flow season was performed. The time interval was established at 1.0 h and the Manning roughness coefficient was applied at 0.025 for the main reach of the Nakdong River and at 0.030 for its tributary, the Keumho River (KMOCT 1992, 1993). These roughness coefficients were calibrated to show a good agreement with the observed water level. After the velocity and depth values of the hydrodynamic simulation arrived at the condition of steady state, these values were used in a two-dimensional advection–diffusion analysis to simulate for DO, BOD, temperature, nitrogen and phosphorus. The dispersion coefficient, which was decided using a relation between the velocity and the depth, was established at 60–80 m<sup>2</sup>/s as the range in the longitudinal direction and at 0.8–1.5 m<sup>2</sup>/s in the transversal direction (Rutherford 1994).

Table 2 shows the flow rate discharge and the water quality data to be used for flow and water quality simulation. These flow rates are annual averaged flow rates in Korea, which usually occur from April to June. Water quality data were also averaged ones sampled and measured by the Ministry of Environment (MOE) during the same periods. In this study area, the BFGS (Broyden–Fletcher–Goldfarb–Shanno) optimization technique was employed for calibration of the deterministic water quality simulation model (Han *et al.* 1999, 2001). Using this calibrated optimal reaction coefficient, the general 1D steady-state water quality model, QUAL2E, and the proposed 2D model, UUWQM, simulate water quality in the Nakdong River for the purpose of model comparison. Figure 4 displays the results of DO and BOD computed by QUAL2E and UUWQM, respectively, to compare with observed data. The concentration and associated error bars are mean and  $\pm$  standard deviation of the water quality data collected from April to June.

The result of BOD, which arrived at a condition of steady state after 24 h, is displayed in Figure 5 with the

Table 2 | Upstream boundary condition of study area

River	Discharge (m <sup>3</sup> /s)	Temp. (°C)	DO (mg/L)	BOD (mg/L)	T-N (mg/L)	T-P (mg/L)
Nakdong	70.0	25.56	9.19	3.01	3.64	0.06
Keumho	7.5	24.00	4.30	8.80	11.31	0.84

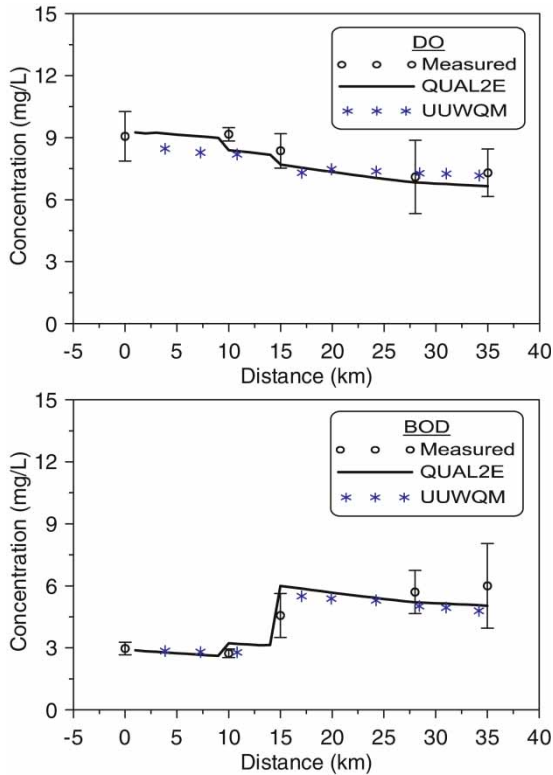

Figure 4 | Simulated results using the deterministic water quality model.

topographical data of the basin area in a grid format in the ArcView GIS program.

### Results of reliability analysis

Reliability analyses were performed based on the aforementioned simulations of deterministic hydrodynamic and water quality analyses. The developed model in this study is able to be applied to analyze the effect of uncertainty that exists in the input parameters of the model. The uncertainties of input parameters were estimated from a literature review (Bowie *et al.* 1985; Brown & Barnwell 1987) and chosen as appropriate for this model. The five main sites shown in Table 3 were selected to analyze the uncertainties of input parameters in this model. The water quality variables to be considered at the mentioned sites are DO and BOD, which are widely used variables to represent the degree of water quality, as well as  $\text{NH}_3\text{-N}$  and  $\text{PO}_4\text{-P}$ , which are closely related to eutrophication among nitrogen series and phosphorus series.

The key input parameters, which have a significant influence on the output variables at the Goryeong Bridge (location 4), were decided considering the contribution of each input parameter. The contribution is represented as follows (Yoon 1994):

$$\text{Contribution (\%)} = \frac{\text{Component of variance}}{\text{Total variance}} \times 100 \quad (16)$$

where the component of variance is a weighting of an input parameter variance by the square of sensitivity. Fourteen key input parameters that affect the variance of the four output variables were selected from a total of 80 in this model. These parameters are shown in Table 4. Table 5 shows the sum of the contributions of the 14 key input parameters.

In the analysis of urban drainage system, Willems (2008) addressed that the uncertainty of the water quality module is bigger than the quantity one based on the concept of variance decomposition. However, Freni & Mannina (2010) stressed that one should consider possible correlations of uncertainty sources during the application of the variance decomposition approach. In this study, the mean and coefficient of variation (CV) of the four output variables procured using the key input parameters was verified with the MCS method against the results computed from all 80 input parameters. This is to evaluate the impact of key parameter selection without considering the correlation of the variance (CV) for the results of uncertainty analysis. The results from 1,000 runs of each set of parameters are represented in Table 6. The table shows that the results in each case are generally close to each other, containing only slight differences in value. Therefore, the selection of the key input parameters is appropriate.

A reliability analysis using the MFOSM and MCS methods was performed to determine whether or not the exceedance probability violated the existing water quality standards at the Goryeong Bridge (location 4) and the Dal-seong intake (location 5). Water quality is a crucial issue at these locations, which serve as the Ministry of Environment's focal site for the water quality survey and a major intake for water supply, respectively. The exceedance probability (risk) means that the computed concentrations of



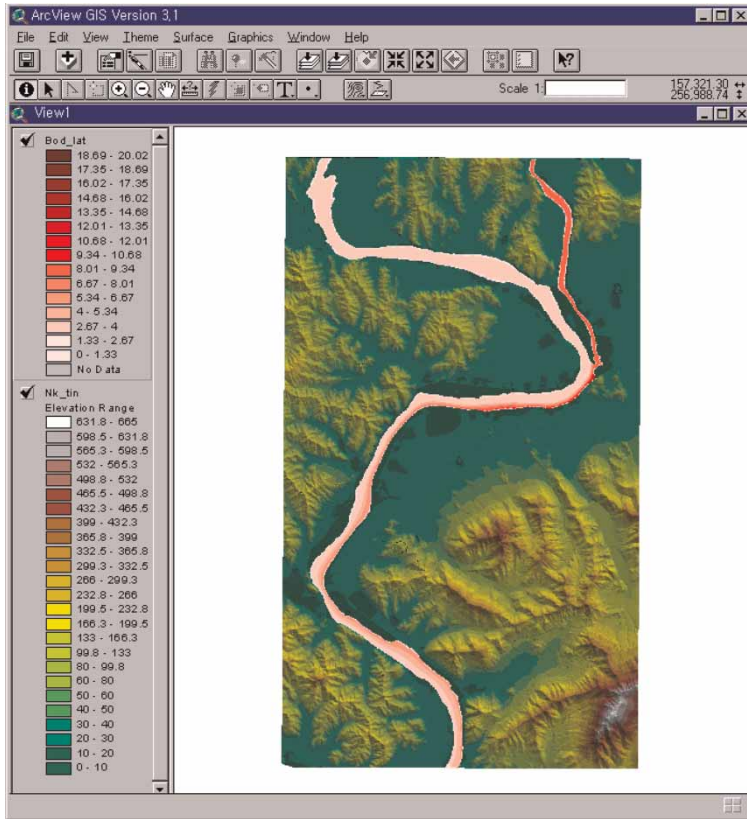

Figure 5 | BOD concentration displayed in the ArcView GIS.

Table 3 | Selected sites for the uncertainty analysis

Location number	Node number	Distance from the conjunction of the Keumho River (km)	Remarks
1	3128	3.13	–
2	4550	6.50	–
3	5173	9.81	–
4	5997	13.94	Goryeong Bridge
5	7457	21.20	Dalseong intake

the output variables, except for DO, have the probability to exceed the allowance of the standard. In contrast to most output variables, the risk for DO represents the probability that the computed results will not exceed the allowance of the standard. Figure 6 shows the results of the reliability analysis for DO and BOD, which are generally known as the most important variables for water quality control,

Table 4 | List of the key input parameters

Variable	Description
DISPXD(N)	Longitudinal diffusion coefficient in the Nakdong River
DISPYD(N)	Lateral diffusion coefficient in the Nakdong River
DISPXD(K)	Longitudinal diffusion coefficient in the Keumho River
BODU5	Convert coefficient of ultimate BOD to 5-day BOD
THET4	Temperature coefficient of organic-N decay
THET6	Temperature coefficient of ammonia-N decay
THET9	Temperature coefficient of organic-P decay
THET12	Temperature coefficient of BOD decay
BET3	Org-N to NH <sub>3</sub> -N conversion rate
BET1	NH <sub>3</sub> -N to NO <sub>2</sub> -N conversion rate
BET4	Org-P decay rate
K1	BOD decay rate
SIG6	BOD settling rate
K4	Sediment oxygen demand rate

**Table 5** | Sum of the contributions of the key input parameters

Output variables	DO	BOD	NH <sub>3</sub> -N	PO <sub>4</sub> -P
Sum of the contributions (%)	97.629	98.982	99.518	100.00

using the MFOSM and MCS methods at location 4. These cumulative distribution curves were then used for computing the frequency distributions of the output variables from both methods. The frequency distribution of BOD is represented in Figure 7. The results at location 5 were very similar to those at location 4, as shown in Figures 8 and 9.

The ranges of DO and BOD were 6.67–7.65 mg/L and 4.70–6.71 mg/L at Goryeong Bridge, and 6.70–7.70 mg/L and 4.53–6.47 mg/L at Dalseong Intake. With this model, it is possible to consider the deterministic analysis and the reliability analysis of water quality for any interesting sites. In terms of practical use in this study area, the MFOSM method would seem to be the most appropriate when considering its computational simplicity and shorter execution time.

### CONCLUSION

In this study, UUWQM based on the finite element method, was developed to consider two-dimensional water quality control problems. This model is able to simulate the 12 water quality variables and to control the

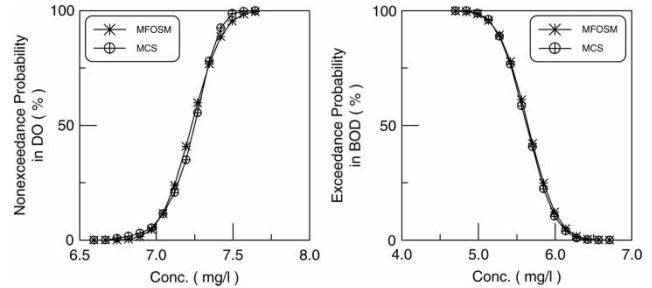

**Figure 6** | Results of reliability analysis estimated at the Goryeong Bridge station (location 4).

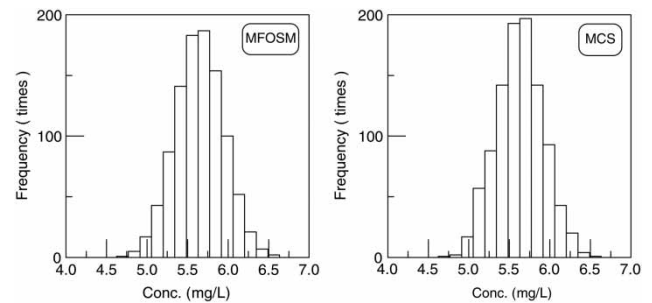

**Figure 7** | Frequency distributions of BOD estimated at the Goryeong Bridge station (location 4).

point/nonpoint sources in the steady/unsteady state. For uncertainty analysis of the deterministic water quality simulation the MFOSM and MCS methods were employed in this study.

The UUWQM was applied to perform two-dimensional hydrodynamic and water quality analyses of a 35.04 km

**Table 6** | Verification results for the key input parameters

Location number	Input parameters	DO (mg/L)		BOD (mg/L)		NH <sub>3</sub> -N (mg/L)		PO <sub>4</sub> -P (mg/L)	
		Mean	CV	Mean	CV	Mean	CV	Mean	CV
1	Key	7.915	0.017	2.999	0.054	0.604	0.037	0.074	0.019
	All	7.927	0.019	2.986	0.055	0.602	0.037	0.074	0.018
2	Key	7.895	0.019	3.010	0.057	0.585	0.041	0.073	0.021
	All	7.908	0.020	2.996	0.058	0.583	0.040	0.073	0.020
3	Key	7.658	0.019	3.861	0.057	0.779	0.032	0.089	0.021
	All	7.671	0.020	3.847	0.057	0.778	0.033	0.089	0.020
4	Key	7.213	0.020	5.649	0.051	1.177	0.016	0.125	0.013
	All	7.229	0.021	5.630	0.051	1.176	0.016	0.125	0.014
5	Key	7.257	0.021	5.443	0.051	1.123	0.019	0.122	0.017
	All	7.274	0.021	5.424	0.051	1.121	0.019	0.122	0.018

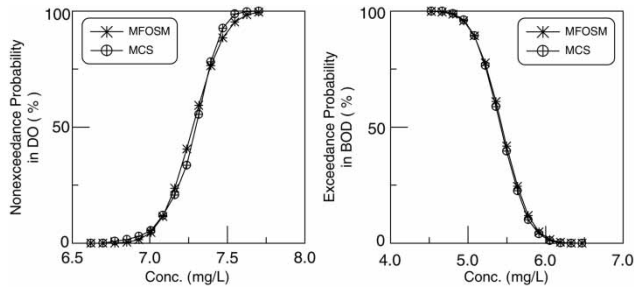

Figure 8 | Results of reliability analysis estimated at the Dalseong intake (location 5).

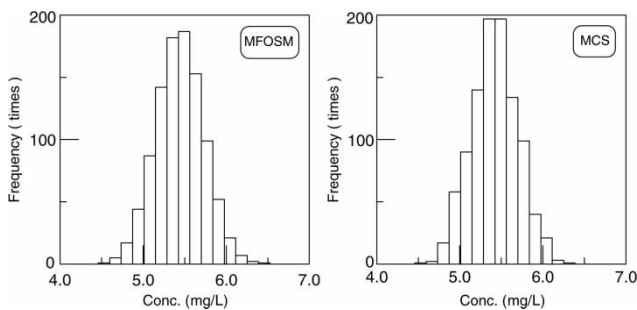

Figure 9 | Frequency distributions of BOD estimated at the Dalseong intake (location 5).

reach of the Nakdong River. The key input parameters out of a total of 80 which contribute the variation of output results were verified by the MCS method. In this study area, selected key parameters were closely related with the uncertainties of the output results such as DO, BOD,  $\text{NH}_3\text{-N}$  and  $\text{PO}_4\text{-P}$ .

Using the key input parameters, the MFOSM and MCS methods were applied to test the reliability of simulated results computed at several key stations based on the exceedance or non-exceedance probabilities. From the frequency distributions of output results, the reliability of DO and BOD computed using both methods was almost identical, demonstrating that the MFOSM is an efficient and robust tool to evaluate the uncertainty of water quality simulations. From a practical decision-making perspective, the performance of the MFOSM method is more attractive because of its lower computational complexity and less effort for execution.

In addition, the proposed model is useful for stochastic analysis of the water quality modeling in establishing the water quality planning and management of the Nakdong River.

## REFERENCES

- Ang, A. H. & Tang, W. H. 1984 *Probability Concepts in Engineering Planning and Design*, Vol. II. John Wiley & Sons, New York.
- Bowie, G. L., Porcella, D. B., Campbell, C. L., Pagenkopf, J. R., Rupp, G. L., Johnson, K. M., Chan, P. W. H., Gherini, S. A. & Chamberlin, C. E. 1985 *Rates, Constants, and Kinetic Formulation in Surface Water Quality Modeling*. Technical Report EPA-600/3-85/040. US Environmental Protection Agency, Athens, GA.
- Brown, R. T. & Barnwell, T. O. 1987 *Computer Program Documentation for the Enhanced Stream Water Quality Model QUAL2E and QUAL2E-UNCAS*. EPA/600-3-87/007. US Environmental Protection Agency, Athens, GA.
- Burges, S. J. & Lettenmaier, D. P. 1975 Probabilistic methods in stream quality management. *Water Res. Bull.* **11** (1), 115–130.
- Chadderton, R. A., Miller, A. C. & McDonnell, A. J. 1982 Uncertainty analysis of dissolved oxygen models. *J. Environ. Engng. Div.* **108** (EE5), 1003–1011.
- Dotto, C. B. S., Kleidorfer, M., Deletic, A., Fletcher, T. D., McCarthy, D. T. & Rauch, W. 2010 *Stormwater quality models: performance and sensitivity analysis*. *Water Sci. Technol.* **62**, 837–843.
- Fischer, H. B., List, J. E., Koh, R. C. Y., Imberger, J. & Brooks, N. H. 1979 *Mixing in Inland and Coastal Waters*. Academic, New York.
- Freni, G. & Mannina, G. 2010 *Uncertainty in water quality modelling: the applicability of variance decomposition approach*. *J. Hydrol.* **394** (3–4), 324–333.
- Freni, G., Mannina, G. & Viviani, G. 2009a *Uncertainty assessment of an integrated urban drainage model*. *J. Hydrol.* **373**, 392–404.
- Freni, G., Mannina, G. & Viviani, G. 2009b *Uncertainty in urban stormwater quality modelling: the influence of likelihood measure formulation in the BLUE methodology*. *Sci. Total Environ.* **408**, 138–145.
- Ghanem, A. M. 1995 *Two-dimensional Finite Element Modeling of Flow in Aquatic Habitats*. PhD dissertation, University of Alberta, Edmonton.
- Ghosh, S. & Mujumdar, P. P. 2006 *Risk minimization in water quality control problems of a river system*. *Adv. Water Res.* **29** (3), 458–470.
- Giri, B. S., Karimi, I. A. & Ray, M. B. 2001 *Modeling and Monte Carlo simulation of TCDD transport in a river*. *Water Res.* **35** (5), 1263–1279.
- Gray, W. G. & van Genuchten, M. T. 1978 *Economical alternatives to Gaussian quadrature over isoparametric quadrilaterals*. *Int. J. Numer. Meth. Engng.* **12** (9), 1478–1484.
- Han, K. Y., Choi, H. S. & Kim, S. H. 1999 Analysis of water quality model uncertainty in the Nakdong River. In *Proc. 28th IAHR Congress, Graz, Austria, 22–27 August CD-ROM*.

- Han, K. Y., Kim, S. H. & Bae, D. H. 2001 A Stochastic water quality analysis using reliability methods. *J. AWRA* **37** (3), 695–708.
- Hughes, T. J. R. & Brooks, A. N. 1982 A theoretical framework for Petrov–Galerkin methods with discontinuous weighting functions: application to the streamline-upwind procedure. In: *Finite Elements in Fluids* (R. H. Gallagher, D. H. Norrie & J. T. Oden & O. C. Zienkiewicz, eds.), Vol. 4. Wiley, London, pp. 46–65.
- Katopodes, N. D. 1984 Two-dimensional surges and shocks in open channels. *J. Hydraul. Engng* **110** (6), 794–812.
- Kinnmark, I. P. & Gray, W. G. 1982 Time-weighting of the momentum equation in explicit wave-equation models of surface water flow. In *Proc. 4th Int. Conf. on Finite Elements in Water Resources, Hannover, Germany*. Springer, Berlin, pp. 5.67–5.77.
- Kleidorfer, M., Deletic, A., Fletcher, T. D. & Rauch, W. 2009 Impact of input data uncertainties on stormwater model parameters. *Water Sci. Technol.* **60**, 1545–1554.
- KMOCT 1992 *River Management Plan of the Nakdong River (Supplementary Survey II)*. Korean Ministry of Construction and Transportation (in Korean).
- KMOCT 1993 *River Management Plan of the Nakdong River (Supplementary Survey III)*. Korean Ministry of Construction and Transportation (in Korean).
- Lee, J. K. & Froehlich, D. C. 1986 *Review of Literature on the Finite Element Solution of the Equations of Two-Dimensional Surface-Water Flow in the Horizontal Plane*. US Geological Survey Circular 1009, Denver, CO, USA, pp. 1–65.
- Lindblom, E., Madsen, H. & Mikkelsen, P. S. 2007 Comparative uncertainty analysis of copper loads in stormwater systems using GLUE and grey-box modeling. *Water Sci. Technol.* **56**, 11–18.
- Mailhot, A. & Villeneuve, J. P. 2003 Mean-value second-order uncertainty analysis method: application to water quality modelling. *Adv. Water Res.* **26**, 491–499.
- Melching, C. S. & Anmangandla, S. 1992 Improved first-order uncertainty method for water quality modeling. *J. Environ. Engng.* **118** (EE5), 791–805.
- Melching, C. S. & Yoon, C. G. 1996 Key sources of uncertainty in QUAL2E model of Passaic River. *J. Wat. Res. Plann. Mngmnt.* **122** (2), 105–113.
- Park, S. K. & Miller, K. W. 1988 Random number generators: good ones are hard to find. *Commun. ACM* **31** (10), 1192–1201.
- Piasecki, M. & Katopodes, N. D. 1999 Identification of stream dispersion coefficients by adjoint sensitivity method. *J. Hydraul. Engng.* **125** (7), 714–724.
- Rutherford, J. C. 1994 *River Mixing*. John Wiley & Sons, New York.
- Tang, W. H. & Yen, B. C. 1972 Hydrologic and hydraulic design under uncertainties. In *Proc. Int. Symposium on Uncertainties in Hydrologic and Water Resources Systems, Tucson, AZ*, no 2. University of Arizona Press, Tucson, AZ, pp. 868–882.
- Thorndahl, S., Beven, K. J., Jensen, J. B. & Schaarup-Jensen, K. 2008 Event based uncertainty assessment in urban drainage modelling, applying the GLUE methodology. *J. Hydrol.* **357**, 421–437.
- Tung, Y. K. & Hathhorn, W. E. 1988 Assessment of probability distribution of dissolved oxygen deficit. *J. Environ. Engng.* **114** (EE6), 1421–1435.
- Tung, Y. K. & Yen, B. C. 2005 *Hydrosystems Engineering Uncertainty Analysis*. McGraw-Hill, New York.
- Willems, P. 2008 Quantification and relative comparison of different types of uncertainties in sewer water quality modeling. *Water Res.* **42**, 3539–3551.
- Yoon, G. Y. 1994 *Uncertainty Analysis in Stream Water Quality Modeling: Reliability and Data Collection for Variance Reduction*. PhD dissertation, Rutgers, The State University of New Jersey, New Brunswick, NJ.
- Zhao, D. H., Shen, H. W., Tabios III, G. Q., Lai, J. S. & Tan, W. Y. 1994 Finite-volume two-dimensional unsteady-flow model for river basins. *J. Hydraul. Engng.* **120** (7), 863–883.
- Zou, R., Lung, W. S. & Guo, H. 2002 Neural network embedded Monte Carlo approach for water quality modeling under input information uncertainty. *J. Comput. Civil Engng.* **16** (2), 135–142.

First received 3 October 2010; accepted in revised form 25 May 2011. Available online 27 July 2011