

Extension of the River Water Quality Model No. 1 with the fate of pesticides

Veerle C. J. De Schepper, Katrijn M. A. Holvoet, Lorenzo Benedetti, Piet Seuntjens and Peter A. Vanrolleghem

ABSTRACT

The existing River Water Quality Model No. 1 (RWQM1) was extended with processes determining the fate of non-volatile pesticides in the water phase and sediments. The exchange of pesticides between the water column and the sediment is described by three transport processes: diffusion, sedimentation and resuspension. Burial of sediments is also included. The modified model was used to simulate the concentrations of diuron and chloridazon in the river Nil. A good agreement was found between the simulated pesticide concentrations and measured values resulting from a four-month intensive monitoring campaign. The simulation results indicate that pesticide concentrations in the bulk water are not sensitive to the selected biochemical model parameters. It seems that these concentrations are mainly determined by the imposed upstream concentrations, run-off and direct losses. The high concentrations in the bulk water were not observed in the sediment pore water due to a limited exchange between the water column and the sediment. According to a sensitivity analysis, the observed pesticide concentrations are highly sensitive to the diffusion and sorption coefficients. Therefore, model users should determine these parameters with accuracy in order to reduce the degree of uncertainty in their results.

Key words | chloridazon, diuron, modelling, pesticide fate, river water quality, sediment

Veerle C. J. De Schepper* (corresponding author)

Katrijn M. A. Holvoet

Lorenzo Benedetti

Peter A. Vanrolleghem

BIOMATH, Department of Applied Mathematics, Biometrics and Process Control, Ghent University, Coupure Links 653, B-9000 Gent, Belgium

*Current address: Laboratory of Plant Ecology, Ghent University, Coupure Links 653, B-9000 Gent, Belgium

E-mail: Veerle.DeSchepper@Ugent.be

Katrijn M. A. Holvoet

Piet Seuntjens[†]

VITO, Flemish Institute for Technological Research, Land and Water Management, Boeretang 200, B-2400 Mol, Belgium

[†]Department of Soil Management, Ghent University, Coupure Links 653, B-9000 Ghent, Belgium and Department of

Bio-engineering Sciences, University of Antwerp, Groenenborgerlaan 171, B-2020 Antwerp, Belgium

Peter A. Vanrolleghem

modelEAU, Département de génie civil et génie des eaux, Université Laval, 1065 Avenue de la Médecine, Québec, QC, G1V 0A6, Canada

NOMENCLATURE

A	bottom surface (m^2)	$k_{b,20}$	biodegradation constant at 20°C (d^{-1})
C	concentration (mg L^{-1})	k_{burial}	first-order rate constant for burial (d^{-1})
d	depth (m)	k_{res}	first-order rate constant for resuspension (d^{-1})
d_{max}	maximum thickness of a sediment layer (m)	k_{sed}	first-order rate constant for sedimentation (d^{-1})
E_0	erodibility constant ($\text{g m}^{-2} \text{d}^{-1}$)	K	temperature constant ($^\circ\text{C}^{-1}$)
f_d	fraction of totally dissolved pesticides (-)	$K_{L,GC}$	diffusion mass transfer coefficient (m d^{-1})
f_{DOC}	fraction of sorbed pesticides on dissolved organic carbon (-)	K_{OC}	sorption coefficient ($\text{m}^3 \text{g}^{-1}$)
f_p	fraction of sorbed pesticides on particulate organic carbon (-)	M	mass (g)
f_{sed}	fraction that settles (-)	V	volume (m^3)
k_b	first-order rate constant for biodegradation (d^{-1})	p	porosity (-)
		Q	water flow ($\text{m}^3 \text{d}^{-1}$)

r	reaction rate for conversion processes ($\text{mg L}^{-1} \text{d}^{-1}$)
slp	bottom slope (–)
S	concentration of dissolved component (mg L^{-1})
S_{GC}	pesticide concentration (mg L^{-1})
T_W	mean water temperature ($^{\circ}\text{C}$)
v_s	settling velocity (m d^{-1})
X	concentration of particulate component (mg L^{-1})

Greek letters

θ_H	hydraulic retention time (d^{-1})
τ_b	bottom shear stress (N m^{-2})
τ_{crit}	critical bottom shear stress (N m^{-2})

Subscript

bed	sediment compartment
c	compartment (sediment + bulk water)
d	inflowing water from tributaries
i	state variables
in	inflowing water from upstream
out	outflowing water to downstream
pore	porewater
res	resuspension
sed	sedimentation

INTRODUCTION

Pesticides are of concern to water quality managers and environmental risk regulators to maintain and achieve a good water quality status. From this perspective, dynamic models can form suitable instruments for risk assessment and can help to gain insight into the most important processes determining the fate of pesticides. When pesticides enter an aquatic environment, they are exposed to different physical, chemical and microbial processes. Two processes which have a major impact on the fate of pesticides are the sorption–desorption processes and biodegradation. Both are strongly influenced by the presence of a sediment layer (Warren *et al.* 2003).

The final destination of pesticides in rivers is strongly determined by their sorption behaviour. For hydrophobic organic substances and for soils and sediments with a total

organic carbon content higher than 0.1%, it is proven that the content of natural organic carbon is the dominant sorbent (Karickhoff 1984; Ying & Williams 2000; Chefetz *et al.* 2004; Chen *et al.* 2004). Hence, the sorption can be described by a constant normalized for the organic carbon content (Karickhoff 1984; Warren *et al.* 2003). For sediments with a low organic carbon content (Karickhoff 1984; Ying & Williams 2000; Warren *et al.* 2003) the sorption is proportional to the cation exchange capacity, to the sediment specific surface and to pH (Rae *et al.* 1998; Madsen *et al.* 2000). Besides the clear effect that sorption has on the physical transport, it can also influence directly or indirectly the degradation of the pesticide. The chemical reactivity of a sorbed pesticide is significantly different from that in solution (Warren *et al.* 2003). In addition, pesticides undergo biological breakdown, especially when micro-organisms are able to attach on surfaces such as the sediment–water interface, rocks and plants. Several scientists (Ying & Williams 2000; Smalling & Aelion 2004) believe that the sorption of pesticides to suspended solids and to sediment organic carbon reduces the decay rates of pesticides in water systems. Many studies (Warren *et al.* 2003) have demonstrated an inverse relationship between decay rates and the amount of organic matter. In some cases the opposite is observed, i.e. sorption accelerates degradation which is mainly the consequence of abiotic pathways (Ying & Williams 2000). Hence, natural sorbents, like sediments, form buffers that influence the reactivity of pesticides in a considerable way as they indirectly control processes in the water phase by the release or uptake of pesticides.

There exists a whole range of models predicting the fate of pesticides. Some of them assume steady state conditions, e.g. EXAMS (Burns 2000) and the Mackay Level III Model (Mackay 2001). The advantage of such models is that they require relatively few input data, but they can never reflect the dynamics – both in space and time – observed for pesticides in real river systems (Holvoet *et al.* 2005). As the occurrence of pesticides is highly dynamic and can pose acute toxicity to ecosystems, dynamic models are necessary to perform reliable risk assessments. The European Surface Water FOCUS workgroup (Forum for the Co-ordination of Pesticide Fate Models and Their Use), which is an initiative of the European Commission with the objective to harmonise the calculation of predicted environmental concentrations (PEC), advises us to use the

dynamic TOXSWA model (FOCUS 2002; ter Horst *et al.* 2002). Limitations of this model exist in a short edge-of-field water body and in neglecting sedimentation, resuspension and biomass growth. There also exist non-point source pollution models on the catchment scale such as AGNPS (Merritt *et al.* 2003) and SWAT (Neitsch *et al.* 2002). These models both contain a mix of empirical and physics-based components and do not have closed elemental mass balances.

The purpose of this study was to develop a dynamic model that simulates the fate of pesticides in the water phase and sediments of surface waters. The presented model is an extension of a simplified version of the existing model RWQM1 (Reichert *et al.* 2001; Deksis *et al.* 2004). The strength of the developed model lies in its dynamics, in its ability to deal with closed elemental mass balances and in the fact that it takes into account the most important processes describing the fate of the pesticides in the water phase and the sediments (i.e. biodegradation, sorption, sedimentation, resuspension, diffusion and burial). A model performance evaluation of the developed model was performed for the case of the pesticides diuron and chloridazon in the river Nil, a small stream flowing in a rural area in Belgium. Model predictions are compared with measured concentrations for both pesticides in the water phase as well as in the sediment. In addition, the model predictions were used to study the distribution of both pesticides between the water phase and the sediment in time and space. Furthermore, the sensitivity of the model output to changes

in the model parameters was tested to define the parameters that should be determined with accuracy in order to reduce the degree of uncertainty in the results.

MATERIAL AND METHODS

Study site and pesticides

In this study the model is applied for the 'Nil', a small, hilly basin situated in the central part of Belgium (Figure 1). The Nil catchment drains an area of 32 km², where the main reach is 14 km long and has a retention time of about 1 day. 7% of the area is inhabited and the main crops grown are winter wheat (22% of the catchment area), corn (15%) and sugar beet (10%). 18% of the catchment consists of pasture. The predominant soil type is loam. The Nil catchment was selected because it is a well-documented basin, studied in detail in terms of pesticide application (Beernaerts *et al.* 2005) and comprehensively described by Holvoet *et al.* (2007).

Two pesticides applied in the Nil catchment were selected to be studied in more detail: chloridazon and diuron. Chloridazon is used as a specific herbicide to protect sugar beet, while diuron is a general herbicide which is even used for domestic use. These pesticides were selected among others, because the legislature had decided not to forbid their use in the near future. In addition, diuron and chloridazon

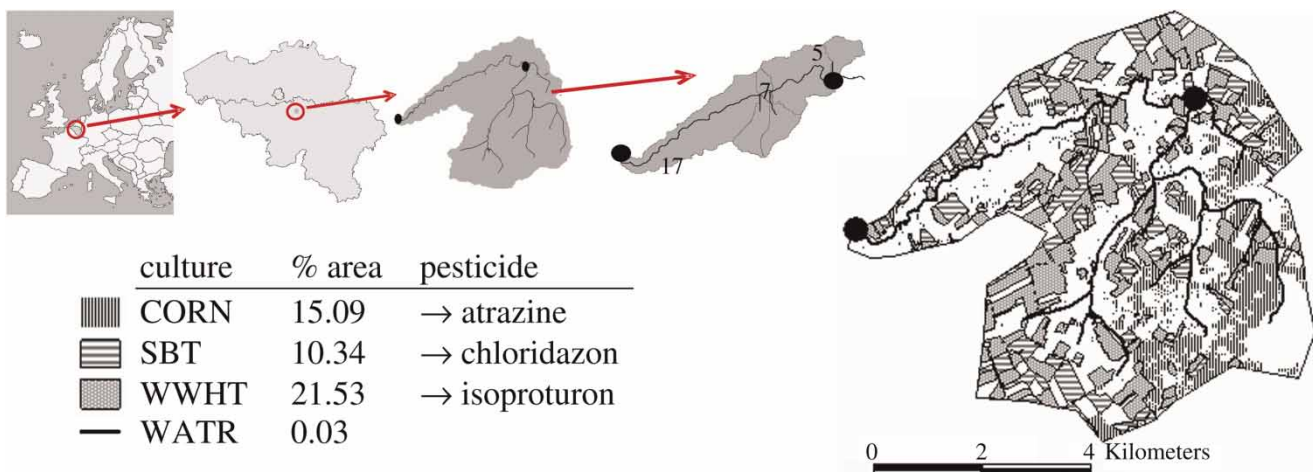

Figure 1 | Location of the Nil catchment with crops and associated areas: CORN = corn, SGBT = sugar beet, WWHT = winter wheat, WATR = water. The • represents two measuring points; the considered sub-catchments are indicated, with their corresponding number.

have clearly different characteristics. Chloridazon contains a pyridazinone compound and is rather hydrophilic, while diuron belongs to the phenyl urea herbicides group and is rather hydrophobic (Table 1). Due to their different properties, their fate in the river is expected to be different.

Monitoring campaign

An intensive monitoring campaign was run during spring 2004: it started on 15 March and ended on 15 June. Two automatic samplers were placed in the river basin, one at the closing section and one upstream (Figure 1). Every 15 min, 50 ml of river water was taken by each sampler resulting in composite samples every 8 h. Pesticide analyses were performed for at least one water sample a day for each monitoring point. For the upstream sampling station, the first sample of the day was always analysed, which represented the samples taken from 0 till 8 o'clock. In order to follow the pollution plug and taking into account a residence time of about 16 h between the two sampling stations, every second sample of the day at the mouth of the river was analysed. Once the results of the screening analyses were available, periods showing high peaks of pesticide concentrations were selected. For these periods, the two remaining samples per day were analysed as well, both upstream and downstream. In addition, one water sample

was weekly analyzed to determine the biological oxygen demand (BOD) and the nutrient concentrations (total N, NO₃-N, NO₂-N, NH₄-N and PO₄-P). An undisturbed sediment sample was taken on 17 May by means of a macrocore and was immediately frozen in the field with CO₂ ice. Once in the laboratory, the sample was sliced and analysed for pesticides in pore water and in the sediment. Besides this collection of water and sediment samples, physiochemical variables (pH, water temperature, conductivity and oxygen concentration) were measured at the mouth of the river using a Hydrolab DS3 (HydroTech, Hutto, TX, USA) multi-parametric probe. A more detailed description of the data collection, sample handling and analysis of the different samples and fractions is given in Holvoet *et al.* (2007). Daily rainfall data for the meteorological station Chastre-Blanmont were obtained from the Royal Meteorological Institute (RMI) and hourly discharge data at the mouth of the river Nil were made available by DGRNE (Direction Générale des Ressources Naturelle et de l'Environnement).

MODEL DESCRIPTION

The main purpose of the developed model was to describe the fate of pesticides in both the bulk water and the sediment

Table 1 | Properties of chloridazon and diuron (Tomlin 2000; Field *et al.* 2003; Caraciolla *et al.* 2005)

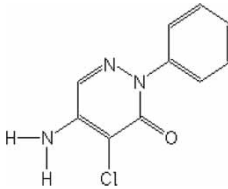
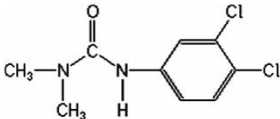
Parameter	Chloridazon	Diuron
Formula		
K_{oc}	89–340	170–1058
Biological degradation in water: $DT_{50water}$ (d)	35–66	30
Photolytic degradation in water: $DT_{50water,photolysis}$ (d)	36.8	–
Hydrolytic degradation in water: $DT_{50water,hydrolysis}$ (d)	Stable	–
$DT_{50water/sediment}$ (d)	74–200	30
$\log K_{ow}$	1.2	2.71
Vapour pressure (mPa)	0.000001	0.0002
Henry coefficient (Pa m ³ /mol)	6,520,000	7,040,000

phase along the river. The model consists of: (1) a submodel describing the water flow along the river and (2) a submodel describing the biochemical and physical processes that pesticides undergo in the sediment and water phases.

Concept of the 'dynamic water flow' submodel

The water flow model consists of a cascade of continuously stirred tank reactors in series (CSTRs) with variable volumes (Beck & Reda 1994; Deksis et al. 2004) (Figure 2). The volume changes are based on the following water mass balance per stirred tank reactor (CSTR):

$$\frac{dV(t)}{dt} = Q_{in}(t) + Q_d(t) - Q_{out}(t) \quad (1)$$

with V the volume of water in the tank at time t (m^3); Q_{in} the inflow from upstream at time t and equal to the outflow of the previous tank (except for the first tank) ($m^3 d^{-1}$); Q_d the flow from tributaries, ground water and run-off along the considered river stretch ($m^3 d^{-1}$) and Q_{out} the outflow of the tank at time t ($m^3 d^{-1}$). The considered tanks have a prismatic shape with a trapezoidal cross section (Deksis et al. 2004). The outflow of the tanks is calculated according to Manning's equation:

$$Q_{out}(t) = A_c(t)/n \cdot \left(A_c(t)/P(t) \right)^{2/3} \cdot \sqrt{s} \quad (2)$$

with A_c the cross section of the tank (m^2), n the Manning coefficient (-), P the wet perimeter (m) and s the slope of

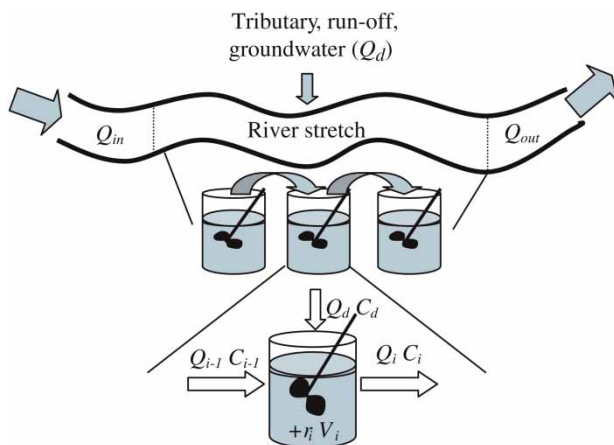

Figure 2 | Schematic representation of continuously stirred tank reactors in series with their conversion reaction rate r .

the river bottom (m/m). The wet perimeter can be calculated from the morphological parameters of the tank which are determined by its trapezoidal shape. The number of tanks and their morphological parameters are dependent on the river under study.

Concept of the 'pesticides fate' submodel

The 'pesticides fate' submodel describes the distribution of pesticides between the bulk water and the sediment. Each CSTR is subsequently subdivided into two compartments which represent the bulk water phase and the sediment phase. Water and pesticides can be exchanged between those two compartments. In each compartment several processes are taking place which determines the fate of the pesticides (Figure 3).

Extension of a simplified version of RWQM1

This submodel is an extension of a simplified version of the IWA River Water Quality Model No. 1 (RWQM1) (Reichert et al. 2001) developed by Deksis et al. (2004). They simplified the RWQM1 by selecting the most important components (nutrients, suspended and dissolved solids) related to the pesticides fate. In our study, this simplified RWQM1 is further extended with the fate of pesticides. Table 2 shows the model components or state variables: the soluble components are represented by means of an S, the insoluble components by means of an X and the subscripts are used to specify state variables. Table 3 represents the possible interactions between the different state variables according to the considered model processes. Deksis et al. (2004) extended their simplified RWQM1 model also with the fate of pesticides (CHETOX1); nevertheless it was chosen in this study to develop a new model. It was found that CHETOX1 did not represent the sediment well. Namely the sediment acted as a biofilm at the bottom of the river in which biodegradation of pesticides occurred according to an empirical equation designed for trickling filters (Melcer et al. 1995). Trickling filters are wastewater treatment plants used to purify water and are always performing under optimal conditions concerning nutrients and oxygen. In a river sediment those optimal conditions almost never appear;

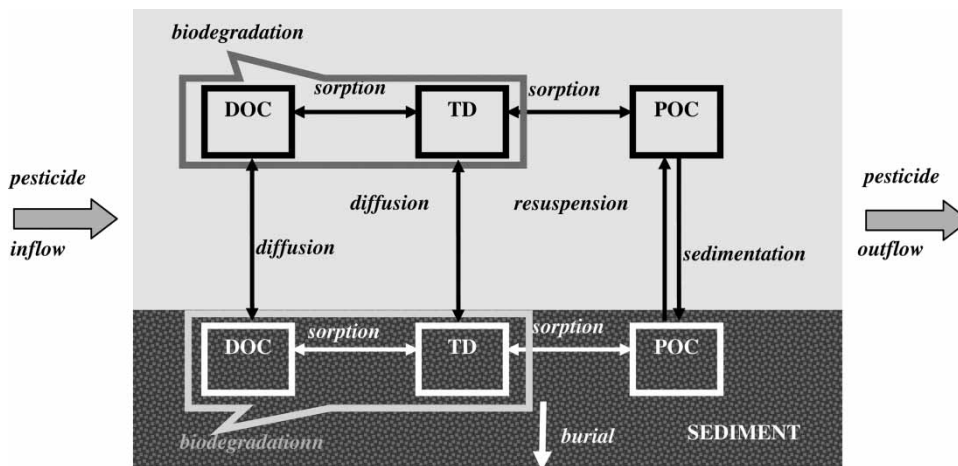

Figure 3 | Schematic representation of processes which determine the fate of pesticides in rivers according to the RM1GC model (based on Deksissa *et al.* (2004)).

Table 2 | State variables in the model, soluble components are represented by means of an S, insoluble components by means of an X, and subscripts are used to specify the different state variables

State variables	Description
1 S_{GC}	Dissolved and sorbed generic compound (pesticide)
2 S_S	Readily biodegradable COD
3 S_I	Inert soluble COD
4 S_{NH}	Ammonia nitrogen (NH_3 and HN_4)
5 S_{NO2}	Nitrite nitrogen
6 S_{NO3}	Nitrate nitrogen
7 S_{PO}	Phosphate phosphorus (H_2PO_4 and HPO_4)
8 S_{O2}	Dissolved oxygen
9 X_H	Heterotrophic biomass
10 X_{N1}	Nitrifying biomass (first step)
11 X_{N2}	Nitrifying biomass (second step)
12 X_S	Particulate biodegradable organic matter
13 X_I	Particulate inert COD
14 X_P	Phosphorus adsorbed to particles

hence this approach of CHETOX1 was not followed. In our study the sediment is approached in a different way. The sediment is seen as a physically separate compartment from the bulk water which contains all the state variables considered in the simplified RWQM1 model (Table 2). The soluble components (components with an S in Table 2) are assumed to be dissolved in the bulk water or pore water of the water and sediment

compartment, respectively. The insoluble components (components with an X in Table 2) of the water compartment represent the suspended load, while they represent the bed load in the sediment compartment. In this case, biodegradation was determined not only by the first-order degradation constant, but also by the environmental conditions such as oxygen and the activity of the heterotrophic biomass (Table 3, component 14).

Mass balance

The simplified RWQM1 (Deksissa *et al.* 2004) was extended with two generic pesticide components, i.e. the state variables S_{GC1} and S_{GC2} . For simplicity, only one variable (S_{GC}) is mentioned in the model description as there are no assumed interactions between the two chemicals. The pesticides are subjected to aerobic biodegradation and sorption processes both in the bulk water and in the sediment compartment. The considered transport processes between the two compartments are sedimentation, resuspension and diffusion. In the sediment compartment a burial process occurs as well (Figure 3). The pesticides can be present in three different forms: totally dissolved in bulk or pore water (TD), sorbed to dissolved organic carbon (DOC) and sorbed to particulate organic carbon (POC).

Pesticide concentrations are calculated by means of mass balances which include the following assumptions concerning the pesticide. The volatilization and hydrolysis

Table 3 | The Petersen matrix for the model represents the interactions between the different state variables according to the considered model processes. In the matrix, the sign '+' indicates a positive stoichiometric coefficient, '-' a negative coefficient, '?' and '(+)' indicates a coefficient of which the sign depends on the composition of the organic substances involved in the processes. For '(+)' the composition should be chosen in such a way the coefficient is positive

Component → <i>i</i>		(1)	(2)	(3)	(4)	(5)	(6)	(7)	(8)	(9)	(10)	(11)	(12)	(13)	(14)
<i>j</i>	Process ↓	S_{GC}	S_S	S_I	S_{NH}	S_{NO_2}	S_{NO_3}	S_{PO}	S_{O_2}	X_H	X_{N_1}	X_{N_2}	X_S	X_I	X_P
(1a)	Aerobic growth of Heterotrophs with NH_4		-		?			?	-	1					
(1b)	Aerobic growth of Heterotrophs with NO_3		-				-	?	-	1					
(2)	Aerobic respiration of heterotrophs				+			+	-	-1				+	
(3)	Anoxic growth of heterotrophs with NO_3		-			+	-	?		1					
(4)	Anoxic growth of heterotrophs with NO_2		-			-		?		1					
(5)	Anoxic respiration of heterotrophs				+		-	+		-1				+	
(6)	Growth of first step nitrifiers				-	+		-	-		1				
(7)	Aerobic respiration of first step nitrifiers				+			+	-		-1			+	
(8)	Growth of 2nd step nitrifiers					-	+	-	-			1			
(9)	Aerobic respiration of 2nd step nitrifiers				+			+	-			-1			
(10)	Hydrolysis		(+)		(+)			(+)	(+)				-1		
(11)	Adsorption of phosphorus							-1							1
(12)	Desorption of phosphorus							1							-1
(13)	Aeration								1						
(14)	Degradation of GC by heterotrophs	-1							-	+					

processes are neglected for both pesticides since their Henry coefficient is low (Tomlin 2000) and they are stable pesticides (Tomlin 2000; ARSUSDA 2006), respectively. Furthermore it is assumed that the sorption equilibrium is reached very quickly, hence the use of a partition coefficient is acceptable.

The mass balances for the pesticide concentrations are as follows:

Bulkwater

$$\begin{aligned}
 & \frac{d(VS_{GC})}{dt} \\
 &= \underbrace{Q_{in}(t)S_{GC,in}(t) + Q_d(t)S_{GC,d}(t) - Q_{out}(t)S_{GC}(t)}_{\text{waterflow}} \\
 & - \underbrace{(k_b 1 - f_p(t))S_{GC}(t)V(t)}_{\text{biodegradation}} - \underbrace{k_{sed}f_p(t)S_{GC}(t)V(t)}_{\text{sedimentation}} \\
 & + \underbrace{k_{res}f_{p,bed}(t)S_{GC,bed}(t)V_{bed}(t)}_{\text{resuspension}} \\
 & + \underbrace{K_{L,GC} \left[(1 - f_{p,bed}(t))S_{GC}(t)/p - (1 - f_p(t))S_{GC}(t) \right] A}_{\text{diffusion}}
 \end{aligned} \quad (3)$$

Sediment

$$\begin{aligned}
 & \frac{d(V_{bed}S_{GC,bed})}{dt} \\
 &= \underbrace{-k_b(1 - f_{p,bed}(t))S_{GC,bed}(t)V_{bed}(t)}_{\text{biodegradation}} \\
 & + \underbrace{k_{sed}f_p(t)S_{GC}(t)V(t)}_{\text{sedimentation}} - \underbrace{k_{burial}S_{GC,bed}(t)V_{bed}(t)}_{\text{burial}} \\
 & - \underbrace{k_{res}f_{p,bed}(t)S_{GC,bed}(t)V_{bed}(t)}_{\text{resuspension}} \\
 & - \underbrace{K_{L,GC} \left[(1 - f_{p,bed}(t))S_{GC}(t)/p - (1 - f_p(t))S_{GC}(t) \right] A}_{\text{diffusion}}
 \end{aligned} \quad (4)$$

where S_{GC} and $S_{GC,bed}$ are the total-dissolved and sorbed-pesticide concentration in, respectively, the bulk water and the sediment (mg L^{-1}); k_b , k_{sed} , k_{res} and k_{burial} are the first-order rate constants for respectively biodegradation, sedimentation, resuspension and burial (d^{-1}); f_p and $f_{p,bed}$ are the pesticide fractions sorbed on suspended and benthic POC (-), respectively; $K_{L,GC}$ is the mass transfer coefficient which describes the diffusion of the pesticide from sediment

to bulk water (m d^{-1}); p is the porosity (-); V and V_{bed} are the volumes of the bulk water and sediment compartment (m^3), respectively, and A is the bottom surface of the reach (m^2).

Calculation of the model parameters

To solve the model a large number of model parameters needs to be provided. For the *sorption* process the most important parameter is the partition coefficient K_{OC} ($\text{m}^3 \text{g}^{-1}$). The use of this coefficient presumes that sorption is proportional to the organic carbon content (Karickhoff 1984; Warren *et al.* 2003). This assumption is reasonable for hydrophobic pesticides (Chefetz *et al.* 2004; Chen *et al.* 2004), such as diuron, and less valid for chloridazon, which is rather hydrophilic. When K_{OC} is known, the fraction of total dissolved pesticides (f_d), of pesticides sorbed on DOC (f_{DOC}) and POC (f_p) can be calculated in each compartment (i) (Karickhoff 1984):

$$f_{p,i}(t) = K_{OC} S_{POC,i}(t) / (1 + K_{OC}(S_{POC,i}(t) + S_{DOC,i}(t))) \quad (5)$$

$$f_{DOC,i}(t) = K_{OC} S_{DOC,i}(t) / (1 + K_{OC}(S_{POC,i}(t) + S_{DOC,i}(t))) \quad (6)$$

$$f_{d,i}(t) = 1 - f_{DOC,i}(t) - f_{p,i}(t) \quad (7)$$

$$\text{with: } S_{DOC}(t) = \alpha_C S_S(t) + \alpha_C S_1(t) \quad (8)$$

$$S_{POC}(t) = \alpha_C X_S(t) + \alpha_C X_I(t) + \alpha_C X_H(t) + \alpha_C X_N(t) \quad (9)$$

where α_C is the fraction of organic carbon calculated according to RWQM1 (Reichert *et al.* 2001). S_{DOC} and S_{POC} are the total soluble compounds of DOC and POC which are derived from state variables calculated according to the simplified RWQM1 and i stands for bulk water or sediment (*bed*) compartment.

The *biodegradation* process for pesticides is typically described according to first-order kinetics (Hamaker 1972; Wu & Nofziger 1999) with temperature-dependent rates:

$$k_b = k_{b,20} \exp(K(T_w - 20)) \quad (10)$$

The exponential term in the above equation corrects the

biodegradation constant at 20°C , $k_{b,20}$ (d^{-1}), with the mean measured temperature in the compartment, T_w . K is a temperature constant and has a typical value of 0.069 ($^\circ\text{C}^{-1}$) (Warren *et al.* 2003). The pesticides sorbed on POC are considered as not biodegradable.

The *sedimentation* process is responsible for the transport of particles from the bulk water to the sediment. The sedimentation rate constant, k_{sed} (d^{-1}), is a function of the settling velocity of the particles and the shear stress on the bottom (Blom & Aalderink 1998; Liu *et al.* 2002; Lumborg 2005; Perianez 2005). To minimize the model complexity, the mass of particles that settles is calculated on the basis of the outflowing flux of bulk water:

$$k_{sed}(t) = \left(1 - \tau_b(t)/\tau_{crit, sed}\right) f_{sed}(t)/\theta_H(t) \quad (\text{if } \tau_b \leq \tau_{crit, sed}) \quad (11)$$

$$k_{sed}(t) = 0 \quad (\text{if } \tau_b > \tau_{crit, sed}) \quad (12)$$

$$\text{with: } \tau_b(t) = 0,5 \rho_w f_c v^2(t) \quad (13)$$

$$f_{sed}(t) = v_s \theta_H(t)/d(t) \quad (14)$$

$$\theta_H(t) = V(t)/Q_{out}(t) \quad (15)$$

$$v_s = g d_X^2 (\rho - \rho_w) / (18\mu\rho_w) \quad (16)$$

where f_{sed} is the fraction of particles that can settle on the basis of their hydraulic retention time and their sedimentation velocity (-); τ_b is the shear stress at the bottom of the river (N m^{-2}); $\tau_{crit, sed}$ is the critical shear stress above which no sedimentation can occur because of turbulence (0.05 N m^{-2}); θ_H is the hydraulic retention time of the bulk water compartment (d^{-1}); v_s is the sedimentation velocity (m d^{-1}); ρ_w and ρ are the density of water and particles (kg/m^3); f_c is the friction factor (-); v is the velocity in the bulk water compartment (m/s); d_X is the diameter of the particles (m); μ is the kinematic viscosity at mean temperature (T_w) and g is the universal gravitational constant (m/d^2). As shown in Equations (11) and (12), sedimentation is only possible when the bottom shear stress is smaller than the critical value.

The *resuspension* process is responsible for particles flowing from the sediment to the bulk water. The calculation of the resuspension rate constant, k_{res} (d^{-1}), is based on an experimentally determined erodibility constant (Blom & Aalderink 1998; Liu et al. 2002; Lumborg 2005; Perianez 2005). It is assumed that resuspension only occurs when the turbulence is higher than a certain value:

$$k_{res}(t) = E_0(\tau_b(t)/\tau_{crit,res} - 1)A/(M_{POC,bed}(t)) \quad (\text{if } \tau_b > \tau_{crit,res}) \quad (17)$$

$$k_{res}(t) = 0 \quad (\text{if } \tau_b \leq \tau_{crit,res}) \quad (18)$$

with E_0 the erodibility constant ($g\ m^{-2}\ d^{-1}$); $\tau_{crit,res}$ the critical shear stress above which resuspension occurs ($0.1\ N\ m^{-2}$); $M_{POC,bed}$ the mass of particles which are in the sediment compartment at a certain time and which is calculated as $S_{POC,bed} \cdot V_{bed}$ (g) and τ_b is the shear stress at the bottom of the river ($N\ m^{-2}$) and is calculated as in Equation (13).

The *burial* process is introduced to create a gradient in the sediment layer. When settled material accumulates on the river bottom, the sediment–water interface is advecting upward and the active layer also moves accordingly. Although the deep sediments under the active layer do not actually move, their distance from the sediment–water interface increases. It is reasonable to conceptualize this process to be a burial process, namely the interface is static and the deeper inactive layers are moving downward (Wang et al. 2003). In the developed model, the sediment consists of three sediment layers: the first two have a maximum thickness and the last one, the deepest layer, is a sink layer with unlimited thickness. The burial rate constant, k_{burial} (d^{-1}), is set proportional to the settling velocity, v_s (Equation (16)):

$$k_{burial}(t) = v_s A / v_{bed} \quad \text{if } (d > d_{max}) \quad (19)$$

$$k_{burial}(t) = 0 \quad \text{if } (d \leq d_{max}) \quad (20)$$

where d is the thickness of the layer and d_{max} is the maximum thickness of the layer. Between the different sediment layers there is only exchange of material by diffusion and burial.

INITIAL AND BOUNDARY CONDITIONS

Boundary conditions

The calibrated SWAT model (Holvoet et al. 2005) estimated the water inflow at the upstream measurement point (Q_{in}) and the water inputs along the selected river coming from tributaries, run-off and groundwater (Q_d). The pesticide concentrations (S_{GC}) of Q_{in} were equated with the measured pesticide concentrations at the upstream measurement point. In contrast to the water input, the pesticide inputs (S_{GC}) of Q_d could not be predicted with the SWAT model, because there were no data available concerning pesticide application doses or dates during spring 2004. Therefore, pesticide inputs from the tributaries and run-off were estimated based on a mass balance. The comparison of the measured pesticide loads passing the upstream and downstream monitoring points gave an estimation of the incoming pesticide mass between these two points. This mass was then spatially distributed based on the land use map (Figure 1). The state variables (Table 2, except S_{GC}) of Q_{in} were calculated from the measured BOD and nutrient concentrations at the upstream measurement point. The mean water temperature (T_w) was set equal to the averaged water temperature ($11.8 \pm 2.8^\circ C$) measured during the entire monitoring campaign. All simulations and the sensitivity analysis were performed for the entire monitoring campaign from 15 March until 15 June, which corresponds to 92 simulation days.

Initial conditions

The actual longitudinal dispersion of pesticides in the river can be overestimated by the use of CSTRS. To minimize this effect, each CSTR is set equal to the river stretch situated in a sub-catchment. The deviation of the river Nil catchment in three sub-catchments was done by a calibrated SWAT model (Arnold et al. 1998) for the Nil catchment (Holvoet et al. 2005) (Figure 1). The SWAT model calculated the required morphological parameters for each sub-catchment (CSTR), i.e. length of the river (L); the slope of the river bank (z) and of the river bottom (s); the Manning coefficient (n); and the depth (d_{bf}) and width (W_{bf}) of the river when it is

at full capacity (Table 4). For each sub-catchment the initial amount of water and sediment was calculated according to their morphological parameters and assuming a sediment porosity of 58% (v/v), which was experimentally determined. The initial values of the state variables (Table 2) were calculated by means of a steady state simulation for both sediment and bulk water compartment of each CSTR. A mean composition of the upstream incoming water was used as model input for this simulation and the simulation time was set to 100 d, because then all variables reached a steady state. These calculated steady state values were used as the initial

state values of the CSTRs during all simulations and sensitivity analysis.

MODEL IMPLEMENTATION IN WEST

The proposed model was implemented in the WEST[®] modeling and simulation software (MOSTforWATER NV, Kortrijk) (Vanhooren *et al.* 2003). Figure 4 shows the WEST[®] configuration of the CSTR-in-series model for the case study of the Nil River. Figure 4 points out that each river stretch consists of one bulk water compartment and one sediment compartment of three tanks for each of the three sediment layers. In the configuration the full and striped arrows represent, respectively, physical and data transfers. The physical transfers refer to mass fluxes, while the data transfer refers to information exchange. How the different transport processes are implemented in WEST[®] is shown in Figure 5. The mass of each component, which is transported from the bulk water to the sediment by sedimentation and diffusion, is calculated in a special 'splitter'. In contrast, the mass that will leave the sediment layer through resuspension, diffusion or burial, is calculated in the sediment compartment itself. The resuspended sediment particles are added to the inflowing

Table 4 | Estimated parameter values of each CSTR (sub-catchment) calculated by a SWAT model (Holvoet *et al.* 2005) for the river Nil

Parameters	CSTR 1 (sub-catchment 5)	CSTR 2 (sub-catchment 7)	CSTR 3 (sub-catchment 17)
W_{bf} (m)	2.5	2.5	3.5
d_{bf} (m)	0.474	0.483	0.517
z	0.5	0.5	0.5
slp	0.0008	0.0008	0.003
n	0.07	0.07	0.07
L (m)	2567	405	4990

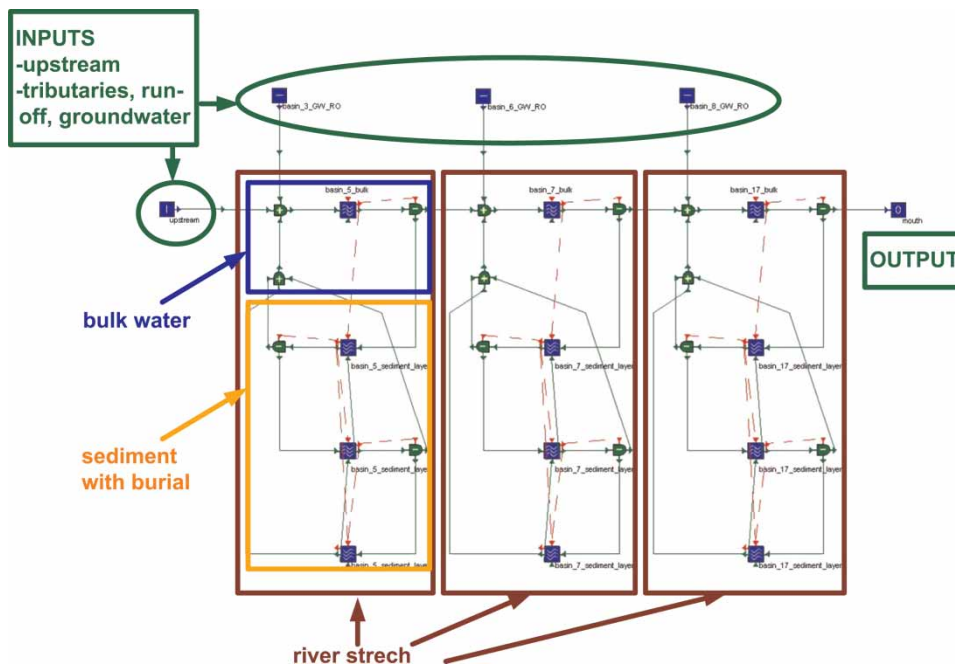

Figure 4 | Model configuration in WEST of the pesticide fate model for the river Nil.

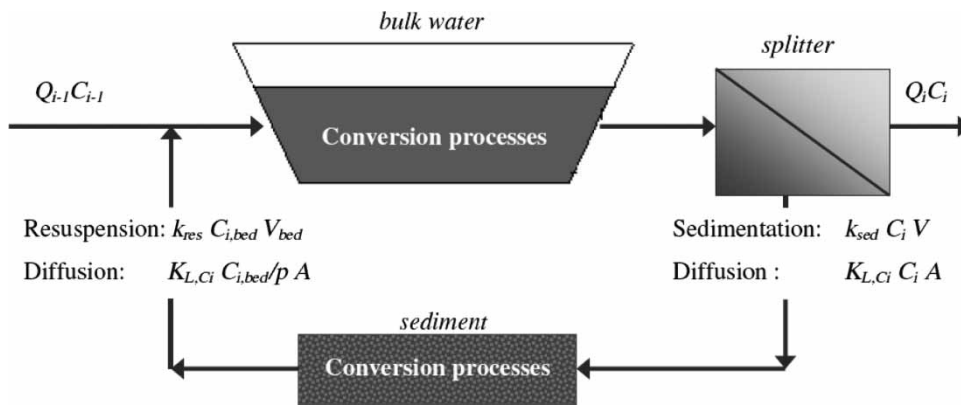

Figure 5 | Schematic presentation of the model implementation in WEST.

bulk water. To get the overall exchange between bulk and sediment, the equilibrium is calculated between the diffusion from the bulk water to the sediment and the diffusion in the opposite direction, namely from the sediment to the bulk water.

SENSITIVITY ANALYSIS

In order to gain insight into the parameter sensitivity of the developed model, a sensitivity analysis was performed with the WEST[®] software. In this way, model parameters that have significant influence on the modelling results can be identified. Uncertainty in influential parameters propagates

into uncertainty in the output results while non-influential parameters are of minor importance in this aspect. This information is useful for model users as it tells which parameters should be investigated with the most accuracy.

In this study, the sensitivity S of a variable R to a parameter P is defined as follows: $S = |\Delta R/R|/|\Delta P/P|$. Note that, as R is a dynamic variable, the sensitivity is also a function of time. The sensitivity analysis was performed for 13 parameters that may have an influence on the fate of pesticides in a river system (Table 5). Each parameter has a certain range of variation, as the exact value is, in most cases, not known or is not determined in the field. The ranges of variation of the parameters in this study are based on the literature and on values observed in the

Table 5 | Parameters and parameter ranges used in the sensitivity analysis. All parameters have a uniform distribution, except n , slp , d_x and $\tau_{crit, sed}$ which have a triangular distribution

Name	min	median	max	Definition	Process
d_x	1	45	60	Particle size diameter (μm)	Sedimentation
E_0	207	–	311	Erodibility constant ($\text{g m}^{-2} \text{d}^{-1}$)	Resuspension
f_c	0.0032	–	0.0048	Friction coefficient (–)	Sedimentation
$k_{b,GC1}$	0.02	–	0.028	Biodegradation constant for pesticide 1 (d^{-1})	Biodegradation
$k_{b,GC2}$	0.0105	–	0.02	Biodegradation constant for pesticide 2 (d^{-1})	Biodegradation
$K_{L,GC1}$	0.00432	–	0.00648	Diffusion coefficient for pesticide 1 (m d^{-1})	Diffusion
$K_{L,GC2}$	0.00432	–	0.00648	Diffusion coefficient for pesticide 2 (m d^{-1})	Diffusion
$K_{OC,GC1}$	89	–	340	Sorption coefficient pesticide 1 ($\text{m}^3 \text{water g}^{-1} \text{POC}$)	Sorption
$K_{OC,GC2}$	453	–	1058	Sorption coefficient pesticide 2 ($\text{m}^3 \text{water g}^{-1} \text{POC}$)	Sorption
n	0.02	0.04	0.07	Manning coefficient (–)	Hydraulics
slp	0.01	0.015	0.02	Slope of the bottom of the river stretch (m m^{-1})	Hydraulics
$\tau_{crit, res}$	0.09	–	0.11	Critical shear stress above which resuspension occurs (N m^{-2})	Resuspension
$\tau_{crit, sed}$	0.045	0.05	0.055	Critical shear stress below which sedimentation occurs (N m^{-2})	Sedimentation

study area (Arnold *et al.* 1998; Blom & Aalderink 1998; Tomlin 2000; Liu *et al.* 2002; Perianez 2005; Lumborg 2005). The outputs studied were the pesticide concentrations in the bulk water, the pore water and on the sediment particles.

RESULTS AND DISCUSSION

Results of the monitoring campaign

Figure 6 represents the measured values upstream and at the closing section in the river Nil during the monitoring campaign. From this figure it is clear that the pesticide concentrations at certain times are much higher downstream than upstream. This phenomenon is mainly caused by run-off (rain) and point losses (in periods without rain) in the considered river section (Holvoet *et al.* 2007).

Simulated values versus measured values

This section verifies whether the simulation results approximate the measured pesticide concentrations. The parameter values in the model were taken from the literature. Hence, no automatic calibration was performed to reach the results presented in Figure 3 and Table 6. However, when a range of literature values was available a manual calibration was performed to select the best parameter values.

The measured pesticide concentrations in the bulk water at the closing section are compared with the

Table 6 | Measured and simulated values of pesticide concentrations in pore water and the amount of sorbed pesticides on the sediment particles at the mouth of the river (MPE: Mean Percentage Error)

Compartment	Pesticide	Measured	Simulated	MPE
Pore water (ng/L)	Chloridazon	940	594	-0.37
	Diuron	1540	73.5	-0.95
Sediment particles (ng/g)	Chloridazon	1.2	2.5	1.08
	Diuron	4.9	13.4	1.73

simulated values in Figure 7. At several times (three times for chloridazon and two times for diuron) there was, for a very brief moment, a major overshoot of the measured pesticide concentration. It appears that the simulated concentrations approximate the measured concentrations well for diuron ($r = 0.521$, $SSE = 1.3 \times 10^{-5}$) and less well for chloridazon ($r = 0.382$, $SSE = 7 \times 10^{-4}$). This discrepancy between chloridazon and diuron can be explained by the differences in the amount of point losses and run-offs which occurred in spring 2004 along the considered river section. From Figure 6 it is clear that the amount of point losses and run-off for chloridazon was much higher than for diuron. There were no data available concerning application doses, dates and point losses, so the pesticides input caused by run-off, groundwater flow and tributaries could not be accurately estimated from the SWAT model (cf. the section on boundary conditions). Due to the larger amount of point losses for chloridazon, more estimations had to be made for this pesticide. Therefore, it is reasonable to assume that the accuracy of the input data for chloridazon is lower than for diuron. Furthermore, it needs to be

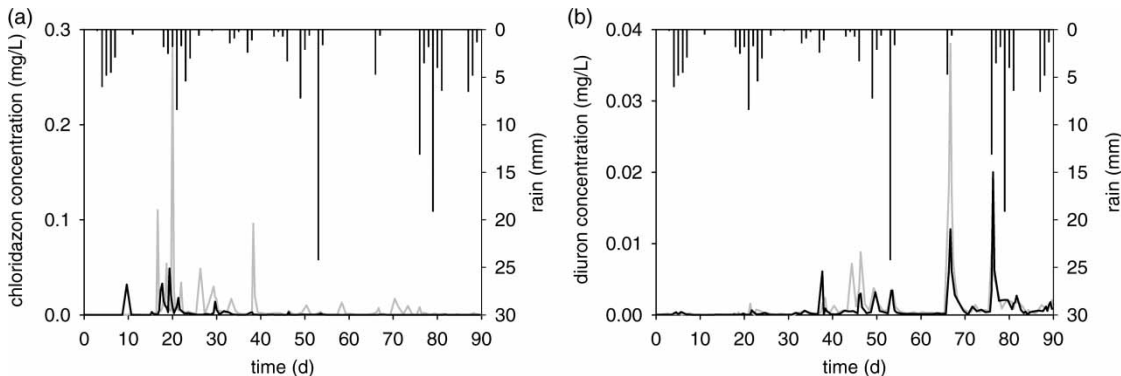

Figure 6 | Measured chloridazon (a) and diuron (b) concentrations upstream (black line) and downstream (grey line) of the river Nil, with measured rainfall (black bars).

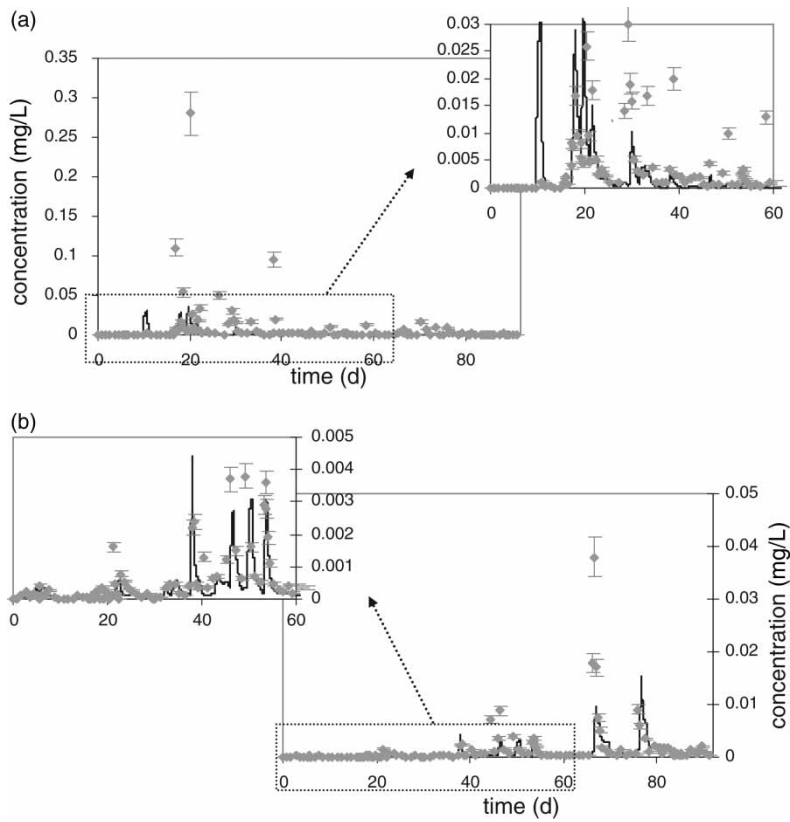

Figure 7 | Simulated (full lines) and measured (dots) concentrations of chloridazon (a) and diuron (b) at the mouth of the river Nil. The data in the dotted box is zoomed in.

mentioned that the water inflow coming from tributaries, groundwater flow and run-off were daily estimations calculated by an existing SWAT model (Holvoet *et al.* 2005). Since the water entering by run-off was estimated as only one value for one day, the run-off peaks on an hourly scale were spread out over the whole day. Hence, an underestimation was made of the real pesticide fluxes which are fluctuating with an hourly timescale as the experimental data showed, especially during periods with large run-offs. Consequently, the estimated pesticide input is not as dynamic as the measured concentrations; therefore, an underestimation could appear when peaks occur.

In Table 6 the measured sediment concentrations observed on 17 May (day 63 in the simulation window) are compared with the simulated values. Measurements were available of pesticide concentrations in the pore water and of the amount of pesticides sorbed on the sediment particles. Table 6 shows that the developed model is able to reasonably predict the pore water concentration

for chloridazon. However, for diuron the simulated pore water concentration downstream is much lower than the real measured concentration. Regarding the pesticides sorbed on the sediment particles, the model overestimates compared to the measured value. This overestimation could be caused by an underestimated measured pesticide concentration: stones were not removed from the sediment in the performed analyses, leading to an overestimation of the sediment weight. Another possible cause is that the parameters from the literature, such as sorption constant and biodegradation constant, are not representative for the considered sediment. If the sorption constant would be calibrated, it is clear that a lower value would generate lower diuron concentrations in the sediment and higher concentrations in the pore water. Finally, it is necessary to mention that data of only one day was available to compare simulated and measured pesticide concentrations in the sediment phase. For a thoroughness validation more data points should be available; consequently, at this stage only a preliminary validation could be performed.

Model-based analysis of pesticide fate in the Nil catchment

The developed model gives the opportunity to study the distribution of pesticides between bulk water and sediment in time and space. Such a distribution is shown in Figure 8, showing the simulated pesticide concentration in the bulk water and in the pore water at the mouth of the river Nil. At the beginning of the monitoring period the chloridazon concentration is higher than the diuron concentration, while at the end of the monitoring period it is just the opposite (Figure 8). This difference is probably caused by the different application periods. The application period of chloridazon lasts from March till April, so it is ended during the simulated period, while for diuron the application period has started up during the simulated period, as it is mainly used from April till July. The profile in Figure 8 shows that the diuron concentrations in the pore water are always lower than the concentrations in the bulk water, while for chloridazon this is not always true. In addition, the shape of the profile is quite different. In the bulk water the pesticide concentrations vary rapidly from very high to very low values. In contrast, the concentration

profile in pore water shows a tailed behaviour, i.e. the concentrations do not vary as much as in the bulk water and maintain elevated levels much longer. For chloridazon this results in a higher concentration in the pore water compared to that in the bulk water at the end of the simulation period (Figure 8(a)). At that moment desorption processes take place in the sediment which gradually release the pesticides attached to the sediment particles into the pore water.

Figure 9 shows the amount of pesticides sorbed to the sediment particles. It seems that the amount of chloridazon sorbed to the sediment particles is almost the same up- and downstream. For diuron there is a huge increase in the sorbed amount in the sediment downstream on 9 May (day 54). The increase is caused by an intense rainfall on 8 May which increased the river flow considerably and caused resuspension in the central reach of the river. At the mouth, sedimentation occurs because of the lower slope in that part of the river. For chloridazon the effect of sedimentation due to its lower sorption constant is much less pronounced. It should also be mentioned that the amount of diuron sorbed to the sediment particles is higher than the amount of sorbed chloridazon, while in

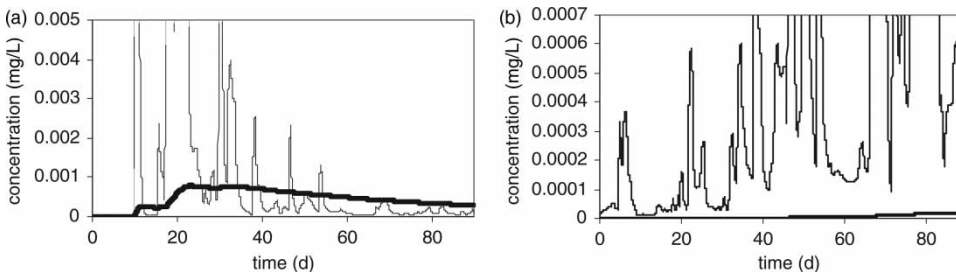

Figure 8 | Simulated concentrations for chloridazon (a) and diuron (b) in the bulk (thin line) and pore water (thick line) at the mouth of the river Nil.

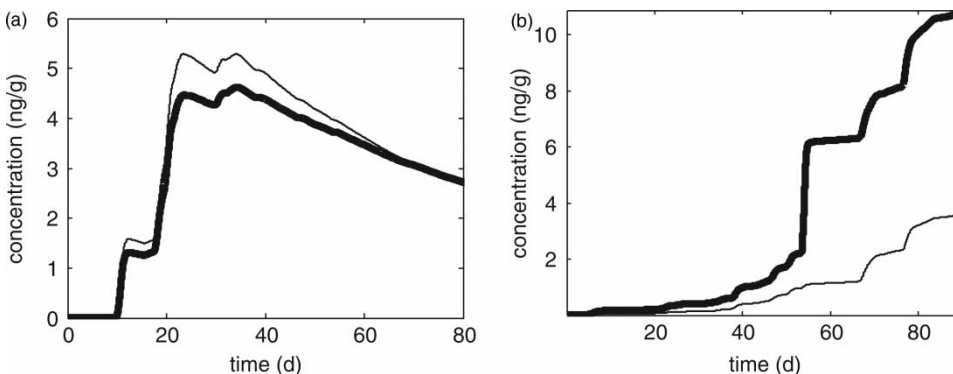

Figure 9 | Simulated amount of chloridazon (a) and diuron (b) sorbed on the sediment particles upstream (thin line) and downstream (thick line) in the river Nil.

the bulk and pore water the chloridazon concentration is higher than the diuron concentration.

Sensitivity analysis

Regarding the 5th, 50th and 95th percentiles of the simulated concentrations for chloridazon and diuron in the bulk water at the mouth (data not shown), it could be concluded that pesticide predictions in the bulk water are not sensitive to the studied parameters. It seems that concentrations in the bulk water are mainly determined by input data rather than by processes in the river system. Figure 10 illustrates the variability in the model results for the pore water and particle concentrations for diuron at the closing section (data not shown), it could be concluded that pesticide predictions in the bulk water are not sensitive to the studied parameters. It seems that concentrations in the bulk water are mainly determined by input data rather than by processes in the river system. Figure 10 illustrates the variability in the model results for the pore water and particle concentrations for diuron at the mouth of the river. These concentrations are much more influenced by the studied parameters than the concentrations in the bulk water. The results for diuron and chloridazon upstream were similar (not shown).

In Figure 11 the sensitivity S of the three output variables to the seven most influential parameters P is visualized. This figure shows that the diffusion coefficient $K_{L,GC}$ is by far the most sensitive parameter for the bulk water concentrations. For the concentrations on the sediment particles, K_{OC} is the most influential parameter for diuron, whereas for chloridazon it is the diffusion coefficient $K_{L,GC}$ closely followed by K_{OC} . As the model predictions for concentrations on particles are influential, it means that the values for these parameters should be assessed with the utmost accuracy to reduce the degree of uncertainty in the results. The importance of a good estimation of the K_{OC} parameter could be expected, as it determines to a great extent the sorption of pesticides on

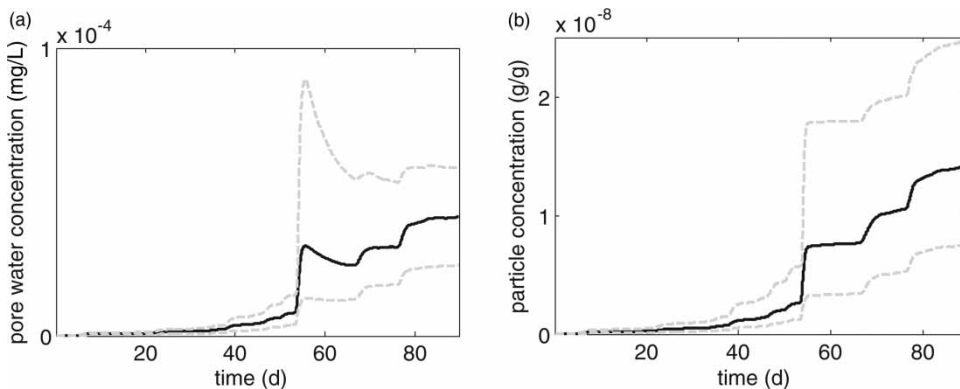

Figure 10 | 50th percentile of the simulated concentrations of diuron in the pore water (a) and on the particles (b) at the closing section (black line) with 5th and 95th percentiles (stripped grey lines).

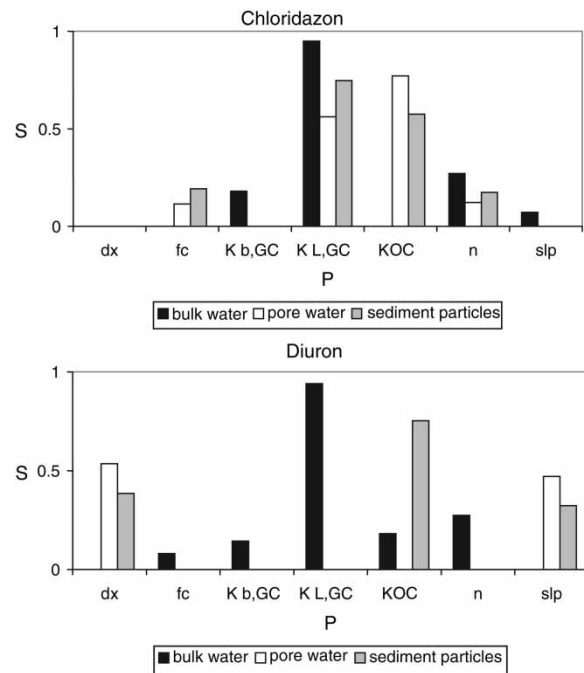

Figure 11 | Graphical representation of the sensitivity S of the three output variables for the seven most influential parameters P for three output variables of the presented model. The definition of the different parameters can be found in Table 5.

particles. For the concentrations in the pore water, the parameters that are most influential for diuron are the particle size diameter (d_x) and the slope of the river stretch. For chloridazon it is K_{OC} and $K_{L,GC}$.

CONCLUSIONS

In conclusion, a simplified version of the RWQM1 model was successfully extended with the fate of pesticides.

A comparison between measured and simulated concentrations in the different compartments of a water–sediment system was performed. This comparison revealed that, in the bulk water compartment, the simulated concentrations underestimated the real concentrations, probably due to incomplete input data. In the sediment compartment the simulated and measured concentrations were of the same order of magnitude, which is a reasonable result, although it should be mentioned that this comparison for the sediment compartment is only preliminary. For a profound comparison more data should be collected.

In the bulk water the pesticide concentrations varied rapidly from high to low values, while the simulated pore water concentrations were much less dynamic. Model simulations showed a different behaviour between the two pesticides, mostly because of their different sorption property. The sedimentation effect was observed to be much more pronounced for diuron, the most hydrophobic pesticide of the two. In addition, the amount of diuron sorbed to the sediment particles is much higher in comparison with chloridazon.

The model can be used to gain insight into the importance of different processes in a river. Therefore, it is important to feed the model with reliable pesticide input data. By means of a sensitivity analysis, it was shown that special attention should be given to the determination of the sorption coefficient K_{OC} and the diffusion coefficient $K_{L,GC}$. A good approximation of both parameters will reduce the uncertainty in the model results for the pore water and particle concentrations.

ACKNOWLEDGEMENTS

The work of LB has been partially supported by the EU CD4WC-project, contract no. EVK1-CT-2002-00118. PV holds the Canada Research Chair of Water Quality Modelling.

REFERENCES

- Arnold, J. G., Srinivasan, R., Muttiah, R. S. & Williams, J. R. 1998 Large area hydrologic modeling and assessment part I: Model development. *J. Am. Wat. Res. Assess.* **34**, 73–89.
- ARSUSDA (Agricultural Research Services Pesticide Properties Database) 2006 US Department of Agriculture. Available at: <http://www.ars.usda.gov/Services/docs.htm?docid=6433> (accessed 8 January 2006).
- Beck, M. B. & Reda, A. 1994 Identification and application of a dynamic model for operational management of water quality. *Wat. Sci. Technol.* **30** (2), 31–41.
- Bernaerts, S., Debongnie, P., Gérard, M., Barthelemy, J.-P., Copin, A., Guns, M. & Pussemier, L. 2005 Evaluation of crop-protection-product losses into surface waters with the SEPTWA system. *Int. J. Environ. Anal. Chem.* **85**, 41–50.
- Blom, G. & Aalderink, R. H. 1998 Calibration of three resuspension/sedimentation models. *Wat. Sci. Technol.* **37** (3), 41–49.
- Burns, L. A. 2000 *Exposure Analysis Modeling System (EXAMS): User Manual and System Documentation*. US Environmental Protection Agency, Washington, DC, EPA/600/R-00/081, p. 206.
- Caracciolo, A. B., Giuliano, G., Grenni, P., Guzzella, L., Pozzoni, F., Bottoni, P., Fava, L., Crobe, A. & Orru, M. 2005 Degradation and leaching of the herbicides metolachlor and diuron: a case study in an area of Northern Italy. *Environ. Pollut.* **134**, 525–534.
- Chefetz, B., Bilkis, Y. & Polubesova, T. 2004 Sorption-desorption behaviour of triazine and phenylurea herbicides in Kishon river sediments. *Wat. Res.* **38**, 4383–4394.
- Chen, Y.-X., Chen, H.-L., Xu, Y.-T. & Shen, M.-W. 2004 Irreversible sorption of pentachlorophenol to sediments: experimental observations. *Environ. Pollut.* **30**, 31–37.
- Deksissa, T., De Pauw, D. & Vanrolleghem, P. A. 2004 Dynamic in-stream fate modeling of xenobiotic organic compounds: a case study of linear alkylbenzene sulfonates in the Lambro River. *Italy. Environ. Toxicol. Chem.* **23**, 2267–2278.
- Field, J. A., Reed, R. L., Sawyer, T. E., Griffith, S. M. & Wigington, P. J. 2003 Diuron occurrence and distribution in soil and surface and ground water associated with grass seed production. *J. Environ. Qual.* **32**, 171–179.
- FOCUS 2002 *FOCUS Surface Water Scenarios in the EU Evaluation Process under 91/414/EEC, Report of the FOCUS Working Group on Surface Water Scenarios*. EC Document Reference SANCO/4802/2002-rev1, p. 221.
- Hamaker, J. W. 1972 Decomposition: quantitative aspects. In: *Organic Chemicals in the Soil Environment* (C. A. I. Goring & J. W. Hamaker eds). Marcel Dekker, New York, vol. I, pp. 253–279.
- Holvoet, K., Seuntjens, P., Mannaerts, R., De Schepper, V. & Vanrolleghem, P. A. 2007 The dynamic water–sediment system: results from an intensive pesticide monitoring campaign. *Wat. Sci. Technol.* **55** (3), 177–182.
- Holvoet, K., van Griensven, A., Seuntjens, P. & Vanrolleghem, P. A. 2005 Sensitivity analysis for hydrology and pesticide supply towards the river in SWAT. *Phys. Chem. Earth* **30**, 518–526.
- Karickhoff, S. W. 1984 Organic pollutant sorption in aquatic systems. *J. Hydraul. Engng.* **110**, 707–735.

- Liu, W.-C., Hsu, M.-H. & Kuo, A. Y. 2002 [Modeling of hydrodynamics and cohesive sediment transport in the Tanshui river estuarine system, Taiwan](#). *Marine Pollut. Bull.* **44**, 1076–1088.
- Lumborg, U. 2005 [Modeling the deposition, erosion, and flux of cohesive sediment through Øresund](#). *J. Marine Syst.* **56**, 179–193.
- Mackay, D. 2001 *Multimedia Environmental Models: The Fugacity Approach*, 2nd edition. Lewis Publishers, Boca Raton, Florida, p. 261.
- Madsen, L., Lindhardt, B. & Rosenberg, P. 2000 [Pesticide sorption by low organic carbon sediments: as screening for seven herbicides](#). *J. Environ. Qual.* **29**, 1488–1500.
- Melcer, H., Parkr, W. J. & Rittman, B. E. 1995 [Modeling of volatile organic contaminants in trickling filter systems](#). *Wat. Sci. Technol.* **31** (1), 95–104.
- Merritt, W. S., Letcher, R. A. & Jakeman, A. J. 2003 [A review of erosion and sediment transport models](#). *Environ. Modell. Software* **18**, 761–799.
- Neitsch, S. L., Arnold, J. G., Kiniry, J. R., Williams, J. R. & King, K. W. 2002 *Soil and Water Assessment Tool User's Manual: Version 2000*. Texas Water Resources Institute, College Station, Texas, p. 438.
- Perianez, R. 2005 [Modeling the transport of suspended particulate matter by the Rhone river plume \(France\). Implications for pollutant dispersion](#). *Environ. Pollut.* **133**, 351–364.
- Rae, J. E., Cooper, C. S., Parker, A. & Peters, A. 1998 [Pesticide sorption onto aquifer sediments](#). *J. Geochem. Explor.* **64**, 263–276.
- Reichert, P., Brochardt, D., Henze, M., Rauch, W., Shanahan, P., Somlyódy, L. & Vanrolleghem, P. A. 2001 *Scientific and Technical Report No. 12: River Water Quality Model No. 1*. IWA Publishing, London, p. 136.
- Smalling, K. L. & Aelion, C. M. 2004 [Distribution of atrazine into three chemical fractions: impact of sediment depth and organic carbon content](#). *Environ. Toxicol. Chem.* **23**, 1164–1171.
- ter Horst, M. M. S., Adriaanse, P. I., Beltman, W. H. J. & van den Berg, F. 2002 *Manual of FOCUS_TOXSWA version 1.1.1*. Draft 27 September 2002. Alterra, Wageningen, The Netherlands, p. 62.
- Tomlin, C. D. S. (ed.) 2000 *Pesticide Manual, A World Compendium*, 12th edition. British Crop Protection Council, Blackwell Scientific Publications, Cambridge, Massachusetts.
- Vanhooren, H., Meilaen, J., Amerlinck, J., Claeys, F., Vangheluwe, H. & Varolleghem, P. A. 2003 [WEST: modelling biological wastewater treatment](#). *J. Hydroinf.* **5**, 27–50.
- Wang, H., Appan, A. & Gulliver, J. S. 2003 [Modeling of phosphorus dynamics in aquatic sediments: I – Model development](#). *Wat. Res.* **37**, 3928–3938.
- Warren, N., Allan, I. J., Carter, J. E., House, W. A. & Parker, A. 2003 [Pesticides and other micro-organic contaminants in freshwater sedimentary environments – a review](#). *Appl. Geochem.* **18**, 159–194.
- Wu, J. & Nofziger, D. L. 1999 [Incorporating temperature effects on pesticide degradation into a management model](#). *J. Environ. Qual.* **28**, 92–100.
- Ying, G.-G. & Williams, B. 2000 [Laboratory study on the interaction between herbicides and sediments in water systems](#). *Environ. Pollut.* **107**, 399–405.

First received 29 January 2010; accepted in revised form 31 August 2010. Available online 12 April 2011