

Temperature effects on bank filtration: redox conditions and physical-chemical parameters of pore water at Lake Tegel, Berlin, Germany

A. Gross-Wittke, G. Gunkel and A. Hoffmann

ABSTRACT

In the city of Berlin, artificial groundwater recharge techniques, such as bank filtration and infiltration ponds, are an important source for drinking water production. Climate change with increasing surface water temperatures can influence the water purification processes during bank filtration mainly due to the intensification of metabolic processes leading to a decrease of oxygen and an increase of anaerobic conditions. In Lake Tegel a significant increase of water temperature in the epilimnion of 2.4°C within the last 30 years was recorded. For a better understanding of induced bank filtration at Lake Tegel, redox processes and physical-chemical conditions within the surface sediment layers (0–26 cm depth) at the littoral infiltration zone were investigated. The influence of temperature in the range of 0–25°C on microbial catalysis of redox processes, such as reduction of nitrate and sulphate, was examined during the period March 2004–June 2005. High water temperatures (16–25°C) were accompanied by negative redox potentials ($E_H = -47$ mV) and decreasing N_{inorg} concentrations, while the amount of ammonia, Mn^{2+} and Fe^{2+} was rising. This indicates redox processes such as denitrification, Mn^{4+} reduction, nitrate respiration and ammonification, as well as Fe^{3+} reduction. The reduction of sulphate, however, has not yet become significant at Lake Tegel, but with increasing water temperature, sulphate reduction must be expected.

Key words | bank filtration, climate change, groundwater recharge, redox chemical processes, self-purification, water temperature

A. Gross-Wittke (corresponding author)

G. Gunkel

A. Hoffmann

Department of Water Quality Control,

Berlin University of Technology,

Sekr. KF 4, Straße des 17. Juni 135,

10623 Berlin,

Germany

Tel.: +49 30 31423791

Fax: +49314 30 23850

E-mail: alexandra.gross-wittke@tu-berlin.de

INTRODUCTION

Bank filtration is an old water abstraction technology and has been used for over 100 years. Different infiltration systems, such as river banks, lake shores and artificial ponds for groundwater recharge have been established (Gunkel & Hoffmann 2009). At present, riverbank filtration is the main water abstraction method used in many European regions, and lake bank filtration also is applied on a large scale in a few places such as Berlin, where 2.6 million inhabitants have been supplied with bank filtration water from Lake Tegel and other sites for about the past 70 years. Water abstraction occurs from over 1,000 wells. Only raw water is

oxygenated for iron precipitation by water sprinkling, and fast sand filtration is used for iron elimination.

Bank-filtration water purification is based on two processes: first, biological self-purification and second, geochemical and hydrogeological processes during groundwater passage (Gunkel & Hoffmann 2009). Biological self-purification is realised by an adapted biocoenosis with high turnover rates, whereas geochemical and hydrogeological processes are characterised by low turnover rates. However, the transit time during bank filtration of about 50 days guarantees water purification by absorption and

doi: 10.2166/wcc.2010.005

metabolisation. The zone with increased bioactivity and its structural components within the interstices, the biofilm, amounts only to a few metres of the bank filtration zone (Brugger *et al.* 2001; Hiscock & Grischek 2002; Gunkel & Hoffmann 2009). This observation is of great interest for water treatment by bank filtration, especially when considering shock loads and physical and chemical disturbances such as temperature increases.

The purification process within the pore water is a redox-dependent biodegradation of organic material, and turnover rates are highly dependent on local redox conditions as well as on temperature. Up to now, little has been discovered about these processes during groundwater recharge. An assessment of redox processes and temperature effects for bank filtration is required for a better understanding of the regulatory mechanisms of biological self-purification and physical-chemical redox processes, as well as their effects on pore water quality in natural and induced bank filtration sites. Degradation of organic material leads to consumption of oxygen, and the resultant use of alternative electron acceptors such as nitrate, manganese, iron oxide, hydroxide and sulphate. This leads to the formation of distinct redox zones along the flow direction (Massmann *et al.* 2008).

Temperature effects on bank filtration are highly significant and have become the focus of further research activities with special regard to climate change and water temperature all over the world, as well as implementation of bank filtration techniques in some subtropical and tropical countries (Sens & Dalsasso 2007; Dash *et al.* 2008; Ray 2008). Temperature change scenarios in Europe vary

regionally but show a clear trend toward warming (EEA 2007; IPCC 2008). For example, regions of the Iberian Peninsula and East Germany are already characterised by low precipitation and little excess of water (Schröter *et al.* 2005). The city of Berlin and the surrounding Brandenburg region is one of the driest regions in Germany, with a negative climate water balance in summer. Therefore, this area is highly sensitive to climate change (PIK *et al.* 2003). In future, the mean discharge of the Havel and Spree Rivers, with extended bank filtration sites, will further decrease, and without this dilution effect, higher sewage and other contaminants will be increasingly concentrated (Gunkel 2009), and will, thus, strongly influence water quality following bank filtration. Lake water warming was registered at Lake Müggel, an enlargement of the Spree River in Berlin, and within 25 years the mean summer surface water temperature had risen about 2.3°C (Adrian *et al.* 2006), with consequences for oxygen and nutrient levels (Wilhelm & Adrian 2008) and phytoplankton response (Huber *et al.* 2008).

MATERIALS AND METHODS

Regional climate

The Berlin region is part of the temperate climate zone, with transition to continental climate. The mean annual temperature is 8.9°C, and the warmest months are July and August, with means of 18.5°C and 17.7°C, respectively (Table 1). Regular hot periods occur with air temperatures

Table 1 | Annual mean climatic characteristics of the Brandenburg region, including Berlin

Climatic feature	Summer mean*	Winter mean†	Annual mean
Precipitation (mm a ⁻¹)	314.4	262.1	603.5
Potential evaporation (mm a ⁻¹)	517.8	110.2	628.0
Climate balance (mm a ⁻¹)	-176.4	-24.5	151.9
Air temperature (°C)	14.7 (max = 39.4)	2.7 (min = -29.5)	8.7
Sun duration (h d ⁻¹)			4.2–4.7
Water temperature (°C)‡	18.5 (24.0 highest monthly mean) (<i>River Havel</i>)	5.65	12.1

*May–October 1951–2000.

†November–April 1951–2000.

‡Water temperature data from IfM (2009); all other data from PIK *et al.* (2003).

up to 39°C. Precipitation amounts to only 603 mm year⁻¹, whereas actual evaporation is 511 mm year⁻¹.

It must be pointed out that occasionally a high epilimnic water temperature occurred in the Berlin lakes: 28.9°C (Lake Tegel, this study) and >30°C (Lake Müggel; R. Adrian, pers. com.). A further temperature increase can lead to periodically ‘tropical’ conditions in this region. Within a scenario until 2055 for Berlin-Brandenburg, the Potsdam Institute for Climate Impact Research estimates an increasing number of hot days (>30°C air temperature) with an increase in sun duration per day in summer compared with the reference period of 1951–2000 (PIK *et al.* 2003).

Study site

Lake Tegel is a lowland lake, a glacial enlargement of the Havel River, situated in Berlin, with an area of 396 ha and a mean depth of 6.6 m. Water balance and water quality are determined by the inflow of two small rivers (Tegeler Fließ, Nordgraben) and by water exchange with the Havel River (Figure 1). After a severe eutrophication period, a phosphate elimination plant was built in 1985, and now the water quality of the lake is mesotrophic, but organic-rich anoxic sediments are still typical, and periodically cyanobacteria blooms occur (Heinzmann & Chorus 1994; Schauser *et al.* 2006). Lake Tegel has a sedge-rich littoral zone with forest stands, sporadically interrupted by beach sections caused by erosion, with sparse macrophyte growth

(reed *Phragmites australis*, water lily *Nuphar lutea*). On the shore of Lake Tegel, water abstraction for Berlin’s water supply is accomplished through several galleries with 116 wells, 30–60 m deep, about 100 m from the lake. The pumping rate of each well ranges from 50 to 150 m³ h⁻¹.

Experiments were conducted at the eastern shore of Lake Tegel in front of the Reiswerder islet (N52°34′13″, E 13°15′25″ to N52°34′10″, E13°15′24″; Figure 1). The littoral zone of Lake Tegel is formed by fine- to medium-sized sands, which are poorly sorted. The theoretical sediment permeability values (k_f) were calculated from sediment grain-size distribution after Beyer (1964) and range from $5 \times 10^{-5} \text{ m s}^{-1}$ to $1 \times 10^{-4} \text{ m s}^{-1}$. The smallest values are in the upper sediment layer, owing to a higher proportion of fine sands; k_f values based on in situ infiltration rates and hydraulic potential, measured in the upper 2 cm, were 4×10^{-7} to $6 \times 10^{-5} \text{ m sec}^{-1}$, indicating severe plugging of the interstices (Table 2, Hoffmann & Gunkel 2009).

Climate change effects in Lake Tegel

Within 28 years (1980–2008), the mean surface water temperature (0.5 m water depth) of Lake Tegel had risen about 2.4°C (monthly mean). This climate change effect is obvious, with increasing minimum temperatures during winter and increasing maximum temperatures in summer (Figure 2). During the period studied, the maximum epilimnic water temperatures reached about 23–25°C. Temperature at the infiltration site was not recorded

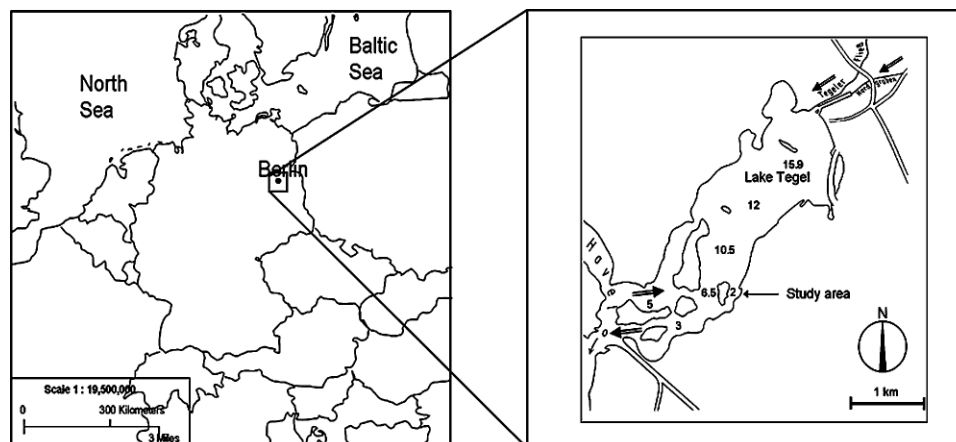

Figure 1 | Map of Central Europe and the study area at Lake Tegel, showing the water depths in meters. Arrows mark water inflow and outflow (modified from Gunkel *et al.* 2009).

Table 2 | Lake Tegel sediment characteristics of the littoral zone

	Sediment depth (cm)					
	0–5	5–10	10–15	15–20	20–25	25–28
Water content (%)	20.3	20.2	11.5	14.5	17.6	16.8
Mean grain diameter (mm)	0.13	0.14	0.27	0.25	0.22	0.23
d_{10} (mm)	0.07	0.07	0.09	0.11	0.09	0.10
Sorting coefficient (S_o)	1.48	1.47	1.61	1.46	1.44	1.41
Porosity	0.40	0.40	0.26	0.31	0.36	0.35
k_f (m sec ⁻¹)*	5×10^{-5}	5×10^{-5}	7×10^{-5}	1×10^{-4}	8×10^{-5}	1×10^{-4}

*According to Beyer (1964).

Source: Hoffmann & Gunkel (2009).

continuously, but we must assume that temperatures in the shallow littoral zone are even higher than in the central lake monitoring station.

Field methods

From March 2004 to June 2005, pore water sampling was conducted monthly at a water depth of 30–50 cm, about 3 m away from the splash water zone close to *Phragmites* and *Nuphar* stands. Pore water was recovered using micro-suction cups (diameter 2.5 mm, length 5 cm; UMS GmbH Munich, Germany). The suction cups were permanently inserted in the interstices in 5 cm steps from 1 to 26 cm sediment depth, fixed in a rack-like acrylic glass tube. This device was placed into the sediment, and the micro-suction cups were inserted horizontally from inside to outside the tube into the undisturbed sediment.

For different sediment depths (at 2–18 cm), oxygen concentrations were determined via optodes: optical oxygen-minisensors (PST3, Precision Sensing GmbH), connected with fibre optics extension cords, and an oxygen meter (Fibox 3, Precision Sensing GmbH) were used. Seven optodes were permanently inserted horizontally into the sediment fixed by an acrylic plate with holes drilled. Measurements were made monthly between November 2004 and December 2005. Nevertheless the application of the optodes in fine sediments needs further investigations due to high variability.

Analytical methods

For the determination of pH and redox potential (E_H) in parallel with pore water sampling, a sediment core was removed using an acrylic glass tube (diameter 6 cm), and

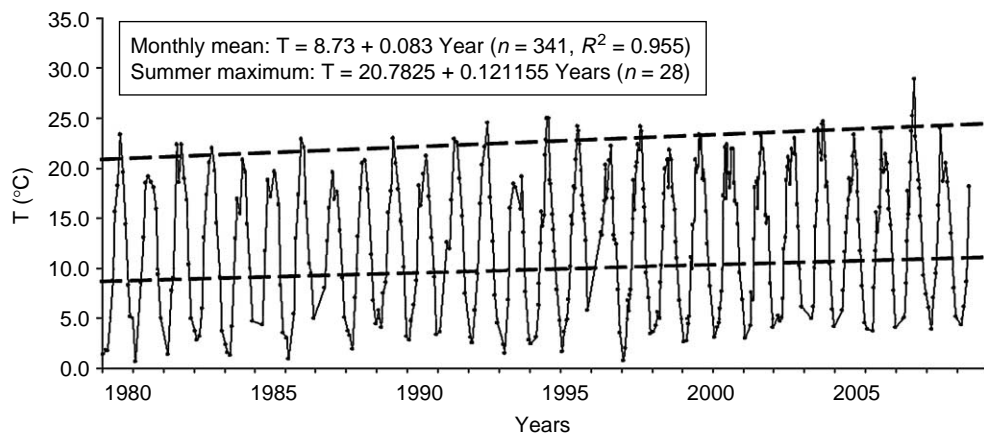

Figure 2 | Surface water heating in Lake Tegel, Berlin, since 1980; water depth 0.5 m, central lake position. Shown are the mean of the years (ANOVA variance analysis; $p = 0.09$) and the maximum summer temperatures (ANOVA variance analysis; $p = 0.01$) (data from Berlin Senate Department for Urban Development).

redox potentials were measured by pushing the sediment in the core sampler upwards step by step and inserting a WTW pH and redox electrode (Pt in Ag/AgCl) every 2 cm into the sediment.

Pore water and lake samples were filtered (0.45 μm pore filter) and analysed immediately in the laboratory. Most parameters were assayed by flow injection analysis (FIAStar 5000, Foss Tecator) because of small probe volumes of a few ml (N_{total} , NO_3^- , and NH_4^+), and metal ion concentrations were determined by atomic absorption spectroscopy (Varian Spektra A 400) after acidification with concentrated nitric acid to $\text{pH} < 2$. Fe, Mn and Ca were analysed using GBC 906A Scientific Equipment. SO_4^{2-} was determined by ionic chromatography (IC Dionex), and dissolved organic carbon (DOC) was analysed using a High TOC Elementar analyser. Nitrite analyses were carried out immediately after sampling in situ using a test kit (Aquaquant, Merck). Lake water was analysed in a similar way using the methods mentioned above.

In analyses by scanning electron microscope with energy dispersive spectroscopy (SEM-EDS), wet mini-cores (1 cm height, 0.7 cm diameter) with sediment were air dried and then sputtered with gold or carbon. The mini-sediment cores were inserted completely into the vacuum chamber of an REM-EDS Hitachi S 2700 electron microscope with an acceleration voltage of 20 kV and IDFix hard- and software from SAMx for analysis.

Data statistical analyses were done by a nonlinear curve fit as well as an extrapolation up to 30°C water temperature by OriginPro 7.5 software. A one-way ANOVA test (OriginPro 7.5) was used for significant level determination.

For further comparison between the electron availability and consumption within the infiltrating lake water (= input into the bank filtration system) and the pore water at >20 cm sediment depth (= output into the groundwater), the redox-equivalent for each redox sensitive species (O_2 ; NO_3^- ; Mn/Fe; SO_4) was calculated on the basis of Equation (1):

$$\text{Redox equivalent} = m/M \cdot z^* \quad (1)$$

m : concentration [mmol L^{-1}];

M : molar mass [mg mmol^{-1}];

z^* : number of electrons transferred.

RESULTS

Lake water

Lake Tegel is a weakly alkaline lake with a conductivity of $767.7 \pm 10.3 \mu\text{S cm}^{-1}$, owing mainly to a high calcium content of 70 mg L^{-1} (Table 3). After treatment of inflow water by a phosphate elimination plant, lake water quality was enhanced and actually can be classified as mesotrophic, but cyanobacterial blooms occur periodically (Schäuser *et al.* 2006). In lake water the main redox components besides O_2 ($11.64 \pm 1.21 \text{ mg L}^{-1}$) are nitrate ($1.65 \pm 0.67 \text{ mg L}^{-1}$), manganese ($17.40 \pm 13.72 \mu\text{g L}^{-1}$), iron (winter mean, $11.67 \pm 3.50 \mu\text{g L}^{-1}$; summer mean, $77.33 \pm 85.23 \mu\text{g L}^{-1}$) and sulphate ($116.80 \pm 14.08 \text{ mg L}^{-1}$). Nitrate has been present for a long time in Lake Tegel water and this points clearly to the eutrophication period, with high N_{inorg} concentrations (up to 12 mg L^{-1}) but low NO_3^- concentrations ($< 2 \text{ mg L}^{-1}$). The recuperation period since 1985 has led to increasing NO_3^- concentrations (up to 6 mg L^{-1}), and since 1995 an oligotrophication period has occurred with decreasing N_{inorg} concentrations and a lack of ammonium, which means that N_{inorg} concentration corresponds to a NO_3^- concentration of about 2.5 mg L^{-1} (Figure 3). During the summer period, NO_3^- concentration decreases to 1.5 mg L^{-1} , and in some years there were no occurrences or only traces of NO_3^- .

Bank infiltration redox conditions and water temperature

The highest E_{H} values were observed at temperatures from 0 to 15°C with maximum redox potentials in the range of +348 mV to +383 mV. The E_{H} values decrease significantly with increasing temperatures in the total sediment zone (0–10 cm); thus, immediately after infiltration pore-water redox potential decreases, no depth gradient was detected in the upper infiltration zone (Figure 4). The redox potentials for the temperature range of 16–20°C varied from +178 to –14 mV, whereas at temperatures between 21 and 25°C even lower E_{H} values with +17 mV and –47 mV were observed.

The pore water concentrations of all investigated redox-active compounds (except for SO_4^{2-}) exhibit temperature

Table 3 | Lake Tegel water chemistry

	Mean (2004/2005)	Standard deviation	Min	Max
pH	8.00	0.34	7.50	8.70
Conductivity ($\mu\text{S cm}^{-1}$)*	767.67	10.27	757.00	789.00
P _{tot} (mg L^{-1})	0.06	0.04	0.03	0.20
Ca ²⁺ (mg L^{-1})	70.38	11.55	48.40	80.00
Chla ($\mu\text{g L}^{-1}$) [†]	14.31	8.61	2.00	32.00
DOC	7.12	0.43	6.30	7.70
O ₂ (mg L^{-1})	11.64	1.21	10.09	13.42
NO ₃ (mg L^{-1})	1.65	0.67	0.85	2.73
NH ₄ (mg L^{-1})	0.10	0.06	0.02	0.21
N _{tot} (mg L^{-1})	1.77	0.66	0.98	2.92
Mn ²⁺ ($\mu\text{g L}^{-1}$)	17.40	13.23	3.30	43.10
Fe ²⁺ ($\mu\text{g L}^{-1}$) winter	11.67	3.50	8.00	16.00
Fe ²⁺ ($\mu\text{g L}^{-1}$) summer	77.33	85.23	18.00	175.00
SO ₄ (mg L^{-1})	116.80	14.08	91.7	133.8

*Data set May–September 2008 (LAGeSo 2008).

[†]Data set May–September 2004 & 2005 (LAGeSo 2008).

dependencies, even if the effect for some of them is small and for some compounds a high variance exists. The influence of temperature on N_{inorg} and NO₃⁻ concentrations in pore water and lake water is variable (Figure 5(a,b)): a statistically significant decline of N_{inorg} and NO₃⁻ in the interstices from 0 to 5°C in comparison with the temperature range 6–25°C was proven, whereas the lowest N_{inorg} and NO₃⁻ values were detected at 11–15°C ($0.62 \pm 0.15 \text{ mg L}^{-1}$ N_{inorg}, respectively $0.59 \pm 0.15 \text{ mg L}^{-1}$ NO₃⁻). The declining N_{inorg} and NO₃⁻ concentrations indicate a bacterial denitrification process within the

interstices ($\text{NO}_3^- \Rightarrow \text{N}_2$), which occurs after oxygen depletion. The scattering of the data is important, because a small-scale patchiness of sediment characteristics occurs as well as a time-dependent variation of infiltration capacity (Hoffmann & Gunkel 2009). The extrapolation of N_{inorg} and NO₃⁻ concentrations in pore water at 26–30°C indicates a further decline, with increasing temperature down to 0.8 mg L^{-1} N_{inorg}, respectively NO₃⁻.

The NO₃⁻/NH₄⁺ redox process also was observed at a Lake Tegel bank infiltration site: NH₄⁺ concentration in pore water rises with increasing water temperature while

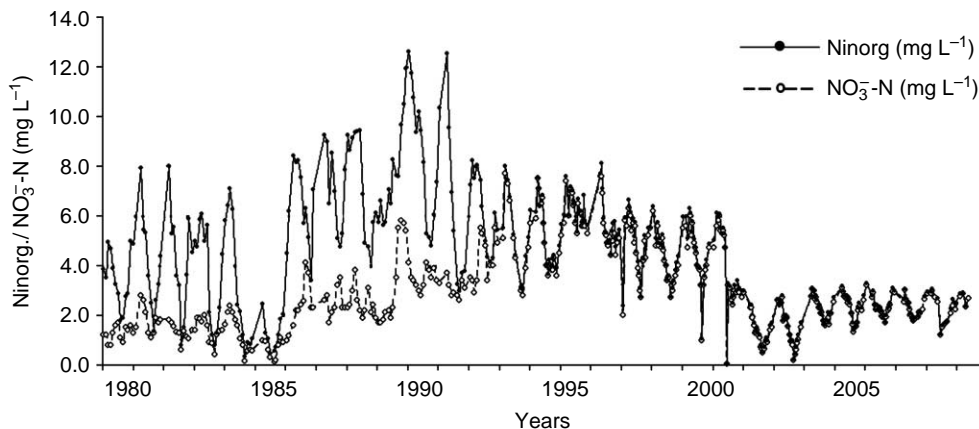
**Figure 3** | N_{inorg} and NO₃⁻ concentrations in surface water of Lake Tegel since 1980; water depth 0.5 m, central lake position (data from Berlin Senate Department for Urban Development).

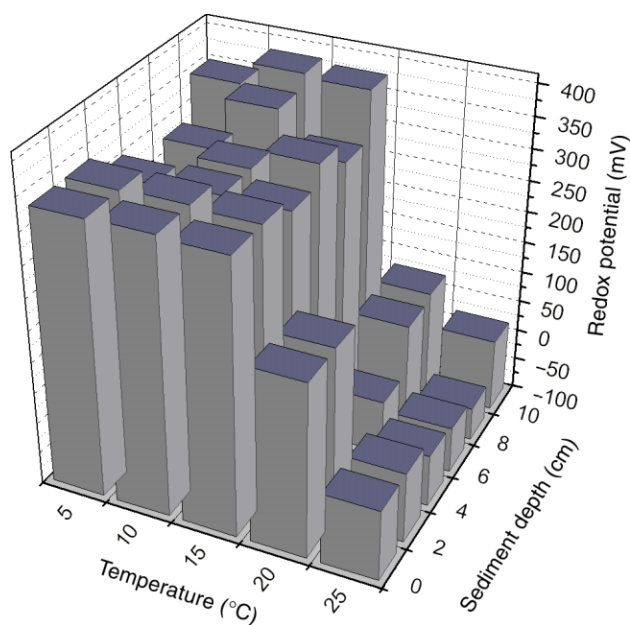

Figure 4 | Redox potentials (mV) at different temperatures within the sediment. Note that the y-axis starts with negative values.

the lake water values do not exceed $0.21 \text{ mg L}^{-1} \text{ NH}_4^+$ (Figure 6(c)). The NH_4^+ pore water concentrations with values up to $0.77 \text{ mg L}^{-1} \text{ NH}_4^+$ at increased temperatures (21–25°C) are significantly ($\alpha = 0.05$) higher than at 0–15°C. Thus a temperature effect occurs, indicating bacterial ammonification as incomplete NO_3^- respiration in the pore water interstices. The extrapolation of the NH_4^+ concentration up to 30°C shows a further increase with a mean concentration of $0.44 \text{ mg L}^{-1} \text{ NH}_4^+$.

The Mn^{2+} and Fe^{2+} concentrations demonstrate the existence of further anoxic processes in the pore water interstices such as redox-chemical reduction of Mn^{4+} to Mn^{2+} as well as of Fe^{3+} to Fe^{2+} , particularly in the higher temperature range of 21–25°C. At temperatures <20°C only traces of Mn^{2+} and Fe^{2+} occurred ($<0.05 \text{ mg L}^{-1}$), whereas at temperatures >21°C an intensive reduction of Mn^{4+} and Fe^{3+} was observed (Figure 5(d,e)). The Mn^{2+} concentrations in the pore water as well as in lake water at <20°C amounted to $<50 \mu\text{g L}^{-1} \text{ Mn}^{2+}$, whereas at 21–25°C concentrations up to $311 \mu\text{g L}^{-1} \text{ Mn}^{2+}$ in the interstices occurred while the lake water concentrations remains below $50 \mu\text{g L}^{-1} \text{ Mn}^{2+}$. For Fe^{2+} pore water concentrations with a mean of $0.030 \pm 0.011 \text{ mg L}^{-1} \text{ Fe}^{2+}$ for 16–20°C were determined, a significantly higher concentration ($\alpha = 0.05$) at 21–25°C occurred with

$0.104 \pm 0.058 \text{ mg L}^{-1} \text{ Fe}^{2+}$. However, for lake water and pore water Fe^{2+} concentrations an assimilable pattern was observed. At temperatures up to 30°C, the extrapolation of manganese ($0.449 \text{ mg L}^{-1} \text{ Mn}^{2+}$) and iron concentrations ($0.177 \text{ mg L}^{-1} \text{ Fe}^{2+}$) showed a further increase in Lake Tegel pore water.

The $\text{SO}_4^{2-}/\text{S}^{2-}$ redox reaction is still without significance in the pore water of the Lake Tegel bank filtration site. The SO_4^{2-} concentrations showed a slight increase with rising temperature and did not differ from the lake water (Figure 5(f)); the mean concentrations of SO_4^{2-} varied from $116 \pm 5 \text{ mg L}^{-1} \text{ SO}_4^{2-}$ at 0–5°C to $130 \pm 9 \text{ mg L}^{-1} \text{ SO}_4^{2-}$ at 21–25°C, possibly an increase owing to higher mineralisation rates in the summer period. A decrease of SO_4^{2-} in pore water interstices was not registered, but desulphurisation had already occurred in the interstices, proven by pyrite crystallisation (Figure 6). At 5–6 cm depth, localized zones with anaerobic conditions occurred, sulphate reduction was enabled, indicating a limiting concentration of redox components with a high E_H potential, even while a high infiltration flow velocity of 0.5 m d^{-1} occurred.

DISCUSSION

Climate change has led to an increase of lake water temperature, and up to now water temperature has increased to 2–3°C during the past 50 years (EEA 2007). Only few data are available about temperature increase of the epilimnic water, which indicates a more intensive temperature increase, e.g. in Lake Müggel of 2.3°C in 25 years (Adrian et al. 2006) and of 2.4°C in Lake Tegel in 28 years (this study). Wilhelm et al. (2006) investigation proved that epilimnic lake water temperature is not simply correlated with air temperature but is a more complex multi-parameter interdependent with air temperature, air moisture and cloud cover.

Surface water warming must be regarded as a significant factor in the bank filtration processes, because infiltration occurs only in shallow littoral zones (Massmann et al. 2008; Gunkel & Hoffmann 2009); deeper (hypolimnic) lake areas are clogged by fine sediments. From an ecological point of view, maximum epilimnic water temperature is regulating bank filtration processes, first by lethal effects of high temperatures on organisms, and second by the intensification

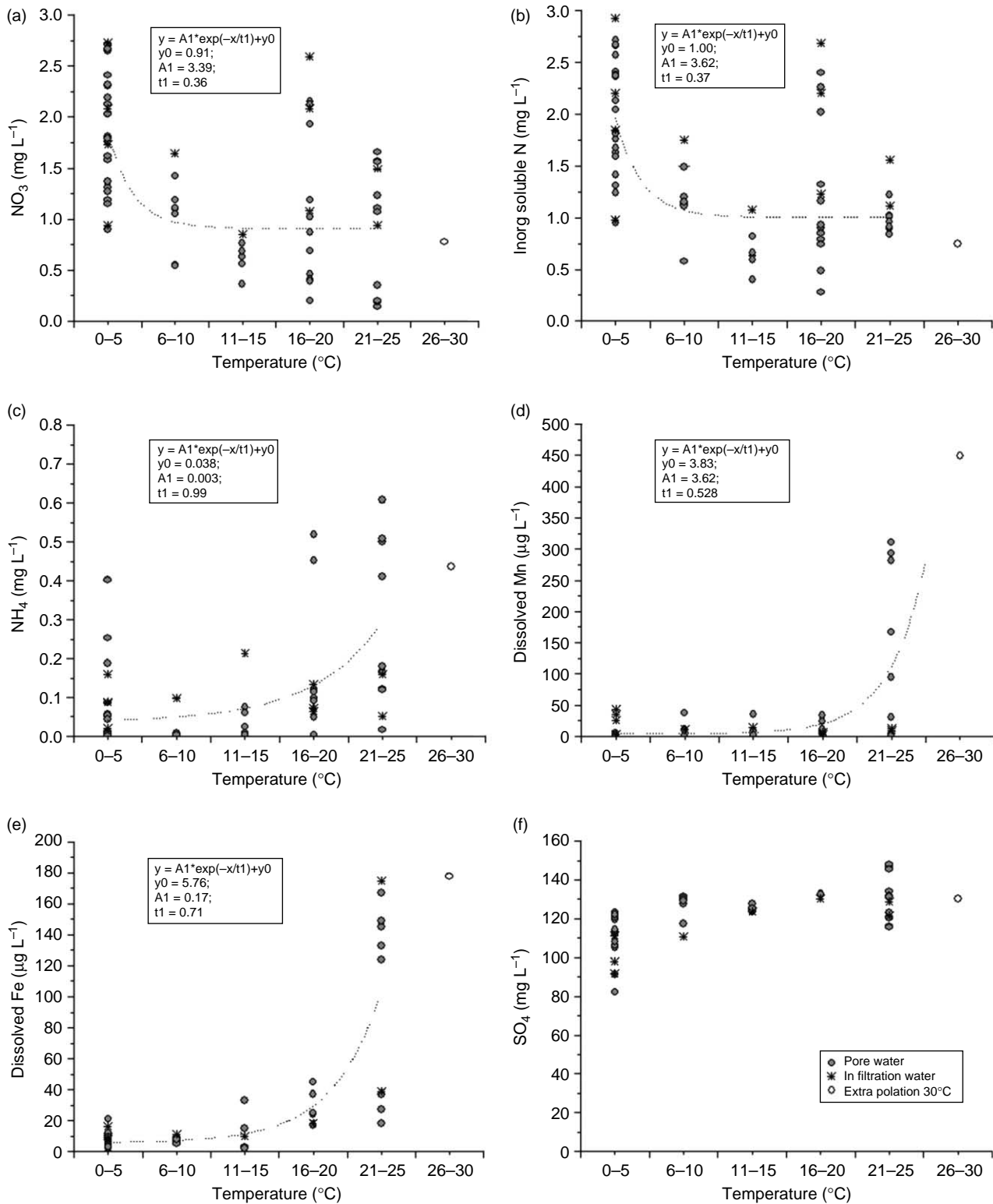

Figure 5 | Pore water (●) and infiltration water (*) concentration at different temperatures. Dashed line shows the nonlinear curve fit (equation box); white dot (○) gives extrapolated concentration values for the temperature range 26–30°C; note that Mn²⁺ and Fe²⁺ concentrations are plotted in μg L⁻¹.

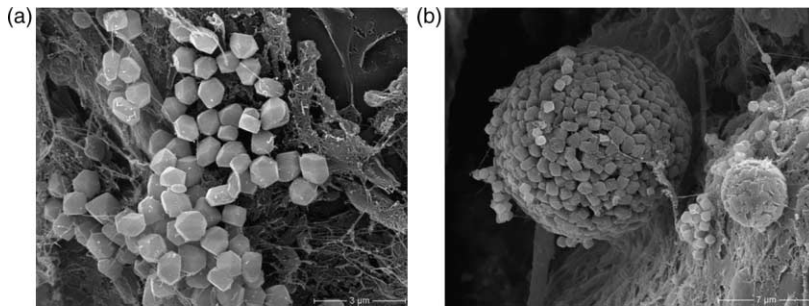

Figure 6 | FeS₂ formation in the interstices (5–6 cm depth) at Lake Tegel bank filtration site. (a): Beginning anaerobic conditions with distinct FeS₂ crystals covering the extracellular polymeric substances (EPS), which form net structures and plaques (right side, above). (b): Matured FeS₂ crystals as framboidal pyrite formed in the EPS. SEM photos; crystal determination by SEM-EDS.

of all metabolic processes in water, leading to a decrease of oxygen and the probability of increased anaerobic conditions in bank filtration zone. Anaerobic conditions cause lethal damage to all aerobic microorganisms as well as to meiofauna, the active components of self-purification processes in bank filtration. The anaerobic microbial community is less effective, and metabolic processes are slower, and this cannot substitute for aerobic bacteria and meiofauna activity.

Sediment redox chemical processes

The theoretical model consists of an infiltrating lake water input flow towards the sediment, which contains oxygen, nitrate, manganese, iron and sulphate as well as fine particulate organic matter and DOC. Distinct redox zones were defined along the flow direction, which proceed from the highest energy yield downwards. After sediment passage through these zones infiltrate/pore water finally reaches groundwater. Water quality of this output flow into groundwater strongly depends on the preceding redox and degradation processes along the bank filtration (Figure 7).

The following major redox zones can be distinguished:

1. Aerobic respiration zone

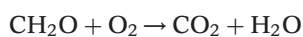

2. Anoxic Fe³⁺, Mn⁴⁺, NO₃ reduction zone

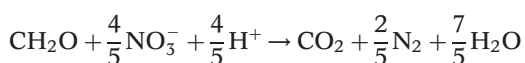
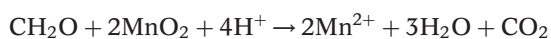
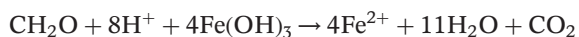

3. SO₄²⁺ reduction zone

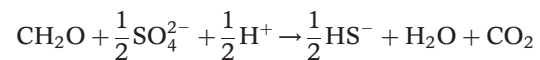

4. CH₄ fermentation zone

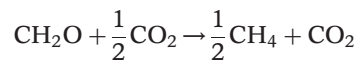

The main part of the microbial community lives within the aerobic zone, and these organisms are primarily responsible for the degradation of organic material. The anoxic zone is characterised by the intense use of alternative electron acceptors and processes like Fe³⁺, Mn⁴⁺, NO₃⁻ reduction as well as denitrification. The toxic SO₄²⁺ reduction as well as CH₄ fermentation zones with the formation of H₂S, S²⁻, and CH₄ cannot be tolerated by the benthic community, and thus are unacceptable from the ecological point of view as well as for the drinking water purification process.

Under undisturbed conditions, littoral lake sediments possess relatively high redox potentials (approximately +300 to +400 mV) owing to low organic matter content and resuspension of the sediment by wind and wave action. But at bank filtration sites, redox potential decreases by intensive infiltration of lake water with its nutrients and dissolved organic matter; the particulate organic matter (POM), however, does not contribute to the turnover processes, because the vertical transport is hindered by the three-dimensional structure of the extracellular polymeric substances (EPS; Gunkel *et al.* 2009). Another factor of significance for the decrease of the redox potential is the water temperature: With increasing water temperature,

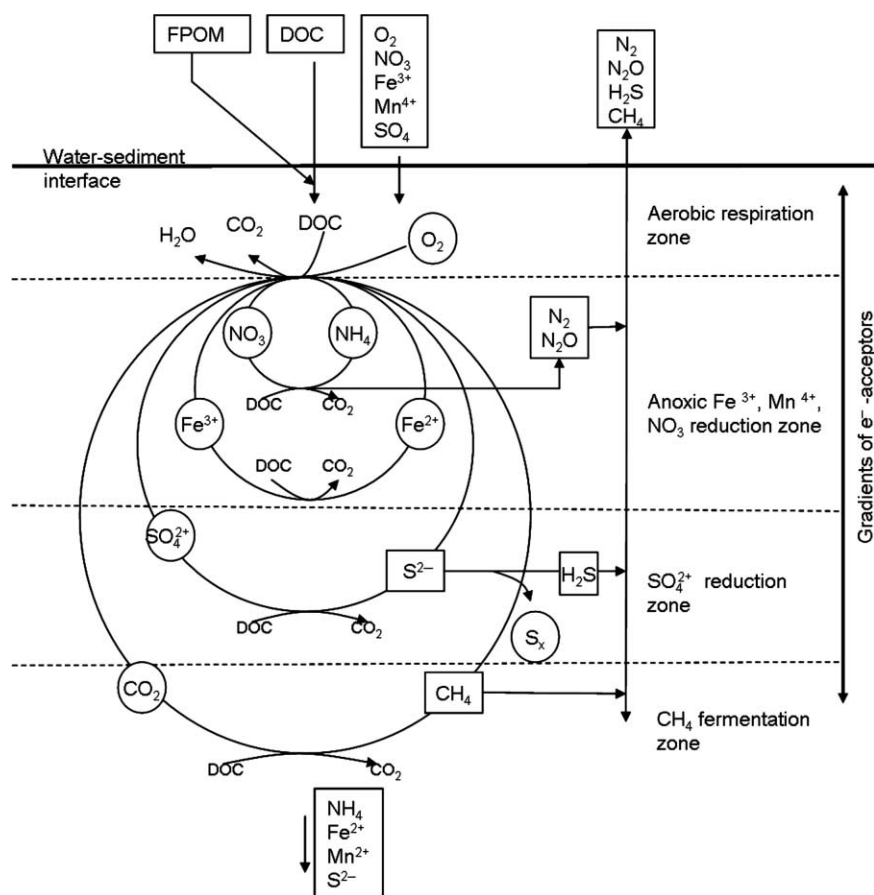

Figure 7 | Theoretical model of biogenic redox processes in the lake infiltration site, modified after *Andreae et al.* (1989).

microbial activity increases, and the oxygen consumption within the sediment also increases. After oxygen depletion, alternative electron acceptors are used step by step (see [Figure 7](#)). Microbially catalysed reduction of nitrate and denitrification starts below E_H values of +421 mV, followed by the reduction of manganese below E_H values of +396 mV. With further decreasing redox potentials, reduced iron appears, and finally desulphurisation starts at E_H values of -100 mV ([Matthess 1990](#)).

This step by step occurrence of sediment-bound redox processes corresponds with the findings of this study at the bank filtration site of Lake Tegel. Especially at high temperatures (21–25°C), the pore water analysis revealed denitrification, ammonification and the reduction of Mn^{4+} and Fe^{3+} , but up to now the sulphate reduction has had no significance; but sulphate reduction and occurrence of S^{2-} has already been demonstrated by pyrite crystallisation at a depth of 5–6 cm. Possibly these anaerobic zones were very

small and were located in dead-end pores of the interstices ([Gunkel & Hoffmann 2009](#)), but the often-discussed hypothesis ([Gunkel et al. 2009](#)) of organic-rich flocs with a redox gradient from outside to inside could not be verified.

Within the infiltrating lake water, the calculation of redox equivalents for e^- acceptors like O_2 , NO_3^- , Mn^{4+} , and Fe^{3+} were $1.5 \pm 0.13 \text{ mmol L}^{-1}$ in total. During the sediment passage from 0 to 26 cm depth the available redox equivalents decreased to about 0.39 mmol L^{-1} . After the depletion of this redox equivalent pool only the SO_4^{2-} -redox equivalents with a mean of $10.53 \pm 0.72 \text{ mmol L}^{-1}$ provides electrons for further reduction/degradation processes of organic matter, but under anaerobic conditions, the formation of toxic S^{2-} .

From an ecological point of view, the sulphate reduction is a catastrophe because of the extreme toxic effect of S^{2-} , and the interstitial biocoenosis with a high abundance and diversity will break down ([Beulker & Gunkel 1996](#)).

The interstitial biocoenosis is the cause of the physical-chemical structure of the interstices because of excretion of EPS, which also accounts for self-purification processes during bank filtration (Gunkel & Hoffmann 2009).

Temperature effects on bank filtration

The capacity of bank filtration is limited by the amount of redox compounds with an $E_H > 0$ mV, as they contain mainly nitrate, manganese and iron. These redox processes are well known during lake eutrophication with an excess of POM and the formation of anaerobic sediments in the hypolimnion of the lake. Additionally an increase in temperature can lead to $E_H < 0$ mV in sediments, because of the reduced solubility of oxygen in water and the intensification of biological as well as biochemical processes. Temperature dependency of redox processes such as denitrification was reported in various studies (e.g. Carrera *et al.* 2003); the maximum denitrification rates were continuously increasing with rising temperatures.

However, with further increase in maximum summer temperature a reduction of SO_4^{2-} and the formation of H_2S must be expected. Studies of bacterial sulphate reduction indicate that environmental temperature is the dominant variable that influences the sulphate reduction rate in sediment; furthermore, optimum temperatures of 30–37°C are reported for sulphate reduction (Abdollahi & Nedwell 1979; Ingvorsen *et al.* 1981).

The future situation of the Lake Tegel bank filtration site depends, on the one hand, on low concentration of nitrate in water mainly from geological conditions in the watershed and by an additional continuous reduction of nitrate due to the implementation of high-efficiency wastewater treatment plants, and on the other hand by dramatically increased temperatures in the epilimnic water. At times complete depletion of nitrate in the water occurs, and other redox compounds such as manganese and iron served in the infiltration zone as electron acceptors, but the capacity of electron acceptors under anoxic conditions is nearly depleted (to 26% of the input) and the occurrence of anaerobic conditions must be expected in future. Recent risk assessment and management strategies are not sufficiently developed concerning water temperature change

and its effects, or the role of nitrate as an electron acceptor in limnic systems.

CONCLUSIONS

With regard to climate change, water warming can lead to large-scale changes in natural self-purification capacities during bank filtration. The consequences of increasing water temperatures in bank filtration at Lake Tegel, Germany, are:

1. a decrease in redox potential owing to intensive microbial and respiratory activity, and the development of anoxic conditions;
2. the intense use of alternative electron acceptors after oxygen consumption, such as NO_3^- microbial catalysed reduction of nitrate/ammonification, denitrification and reduction of Mn^{4+} and Fe^{3+} followed by enrichment of groundwater with manganese, and iron;
3. no significant sulphate reduction so far, but the occurrence of S^{2-} was already shown by pyrite crystallisation within the sediment.

In future, with further increase in maximum summer temperature the expected SO_4 reduction could lead to the breakdown of the interstitial biocoenosis, and by this way of the self-purification capacity.

ACKNOWLEDGEMENTS

We thank the German Scientific Society (DFG) for financing this project (Gu 307/11-1/2). The investigations were supported by Dipl. Ing. Ulrich Gernert, ZELMI and TU Berlin (SEM-EDS). The Senate of Berlin performed the long-term lake monitoring and provided these data, and Cand.-Ing. Florian Selge carried out statistical work on Lake Tegel water-quality data.

REFERENCES

- Abdollahi, H. & Nedwell, D. B. 1979 Seasonal temperature as a factor influencing bacterial sulphate reduction in a saltmarsh sediment. *Microb. Ecol.* 5, 73–79.
- Adrian, R., Wilhelm, S. & Gerten, D. 2006 Life-history traits of lake plankton species may govern their phenological response to climate warming. *Glob. Environ. Change* 12, 625–661.

- Andreae, M. O., Schimel, D. S. & Robertson, G. P. 1989 *Report of the Dahlem Workshop on Exchange of Trace Gases between Terrestrial Ecosystems and the Atmosphere*, Berlin, February 19–24 1989.
- Beulker, C. & Gunkel, G. 1996 Studies on the occurrence and ecology of meiofauna and benthic algae in the littoral sediment of lakes. *Limnologia* **26**, 311–326.
- Beyer, W. 1964 Determination of water permeability of gravels and sands from the grain size distribution curve (Zur Bestimmung der Wasserdurchlässigkeit von Kies und Sanden aus der Kornverteilungskurve.). *WWT (Wasserwirtschaft und Wassertechnik)* **14** (6), 165–168.
- Brugger, A., Reitner, B., Kolar, I., Quéric, N. & Herndl, G. J. 2001 Seasonal and spatial distribution of dissolved and particulate organic carbon and bacteria in the bank of an impounding reservoir on the Enns River, Austria. *Freshw. Biol.* **46** (8), 997–1016.
- Carrera, J., Vicent, T. & Lafuente, F. J. 2003 Influence of temperature on denitrification of an industrial high-strength nitrogen wastewater in a two-sludge system. *Water SA* **29** (1), 11–16.
- Dash, R. R., Mehrotra, I., Kumar, P. & Grischek, T. 2008 [Lake bank filtration at Nainital, India: water quality evaluation](#). *Hydrogeol. J.* **16**, 1089–1099.
- EEA (European Environment Agency) 2007 *Climate change and water adaptation issues. Techn. Report 2*. European Environment Agency, Copenhagen.
- Gunkel, G. 2009 Vulnerability of aquatic systems to climate change—findings from European waters. In: *Sustainable Development: Energy, Environment and Natural Disasters* (eds L. Duarte & P. Pinto), pp. 9–23. Fundação Luis de Molina, Évora.
- Gunkel, G. & Hoffmann, A. 2009 Bank filtration of rivers and lakes to improve the raw water quality for drinking water supply. In *Water Purification* (ed. N. Gertsen & L. Sønderby), pp. 137–169. Nova Science, Hauppauge, NY.
- Gunkel, G., Beulker, C., Hoffmann, A. & Kosmol, J. 2009 Fine particulate organic matter (FPOM) transport and processing in littoral interstices—use of fluorescent markers. *Limnologia* **39**, 185–199.
- Heinzmann, B. & Chorus, I. 1994 [Restoration concept for Lake Tegel, a major drinking and bathing water resource in a densely populated area](#). *Environ. Sci. Technol.* **28**, 1410–1416.
- Hiscock, K. M. & Grischek, T. 2002 [Attenuation of groundwater pollution by bank filtration](#). *J. Hydrol.* **266**, 139–144.
- Hoffmann, A. & Gunkel, G. 2009 [Bank filtration in the sandy littoral zone of Lake Tegel \(Berlin\): Structure and dynamics of the biological active filter zone and clogging processes](#). *Limnologia* (doi:10.1016/j.limno.2009.12.003).
- Huber, V., Adrian, R. & Gerten, D. 2008 Phytoplankton response to climate warming modified by trophic state. *Limnol. Oceanogr.* **53**, 1–13.
- IfM (Institut für Meteorologie der Freien Universität Berlin) 2009 Meteorological mean and extreme values of Berlin-Dahlem–Wassertemperature of River Havel (Meteorologische Mittel- und Extremwerte von Berlin-Dahlem–Wassertemperatur der Havel). <http://www.met.fu-berlin.de/~manfred/extrema.htm#wasser>
- Ingvorsen, K., Zeikus, J. G. & Brock, T. D. 1981 Dynamics of bacterial sulfite reduction in an eutrophic lake. *Appl. Environ. Microbiol.* **42** (6), 1029–1036.
- IPCC (Intergovernmental Panel on Climate Change) 2008 *Climate change and Water. IPCC Technical Paper VI*. UNEP.
- LAGESo (Berlin State Office of Health and Socials) 2008 Data set bathing water monitoring Lake Tegel 1994–2008.
- Massmann, G., Nogeitzig, A., Taute, T. & Pekdeger, A. 2008 Seasonal and spatial distribution of redox zones during lake bank filtration in Berlin, Germany. *Environ. Geol.* **54** (1), 53–65.
- Matthess, G. 1990 *The Composition of Groundwater*. 2nd edition (*Die Beschaffenheit des Grundwassers. 2. Auflage*), *Lehrbuch der Hydrologie 2*, S. 498, Gebrüder Borntraeger, Berlin, Stuttgart.
- PIK (Potsdam Institute for Climate Impact Research), Gerstengarbe, F. W., Badeck, F., Hattermann, F., Krysanova, V., Lahmer, W., Lasch, P., Stock, M., Suckow, F., Wechsung, F. & Werner, P. C. 2003 Study of the climatic development in Brandenburg until 2055, and the impacts on water balance, agriculture and forestry, as well as first perspectives (Studie zur klimatischen Entwicklung im Land Brandenburg bis 2055 und deren Auswirkungen auf den Wasserhaushalt, die Forst- und Landwirtschaft sowie die Ableitung erster Perspektiven). *PIK Report* 83, S.91.
- Ray, C. 2008 [Worldwide potential of riverbank filtration](#). *Clean Technol. Environ. Policy* **10** (3), 223–225.
- Schauser, I., Chorus, I. & Heinzmann, B. 2006 [Strategy and current status of combating eutrophication in two Berlin lakes for safeguarding drinking water resources](#). *Water Sci. Technol.* **54** (11–12), 93–100.
- Schröter, D., Acosta-Michlik, L., Arnell, A. W., Araújo, M. B., Badeck, F., Bakker, M., Bondeau, A., Bugmann, H., Carter, T. & de la Vega-Leinert, A. C. 2005 *ATEAM Final Detailed report, related to overall project duration*. Potsdam Institute for Climate Impact Research. Potsdam.
- Sens, M. L. & Dalsasso, R. L. 2007 Bank filtration of reservoir as an efficient technique for water supply treatment. In *Reservoir and River Basin Management: Exchange of Experiences from Brazil, Portugal and Germany* (ed. G. Gunkel & M. C. Sobral), pp. 253–264. Universitätsverlag TU Berlin.
- Wilhelm, S. & Adrian, R. 2008 [Impact of summer warming on the thermal characteristics of a polymictic lake: consequences for oxygen, nutrients and phytoplankton](#). *Freshw. Biol.* **53**, 226–237.
- Wilhelm, S., Hintze, T., Livingstone, D. M. & Adrian, R. 2006 [Long-term response of daily epilimnetic temperature extrema to climate forcing](#). *Can. J. Fish. Aquat. Sci.* **63** (11), 2467–2477.

First received 14 May 2009; accepted in revised form 11 February 2010