

## Mixing Processes in Lakes

Niels-Erik Ottesen Hansen

Technical University of Denmark, Copenhagen

A review of the available methods for analyzing turbulent mixing in lakes is presented. The different types of flow are classified and their turbulence characteristics described. The diffusion caused by turbulence is examined with the conclusion that no reliable analytical description is available for the moment, so for technical purposes field surveys are recommended. Entrainment processes in stratified lakes are analyzed by considering the turbulent energy exchange, and analytical expressions for common types of flow are presented. Finally windrows, their origin and their effect on the mixing are described.

### Introduction

The aim of this paper is to give a short review of the knowledge obtained so far of the mixing processes in lakes and reservoirs. The first part is devoted to an identification of the different mechanisms, whereas theory and analysis are presented in the following parts.

Turbulence is by far the most important source for mixing in lakes, so before more detailed analyses of the mixing processes are presented a short description of the lake-turbulence is given. This turbulence is either generated by direct wind action or by shear action of currents. The wind action is the most important and is characterized by the set up of a current with a large production of turbulent energy close to the water surface – see Fig. 1. The greater part of this energy is dissipated in the same area whereas the rest is transported down to lower levels.

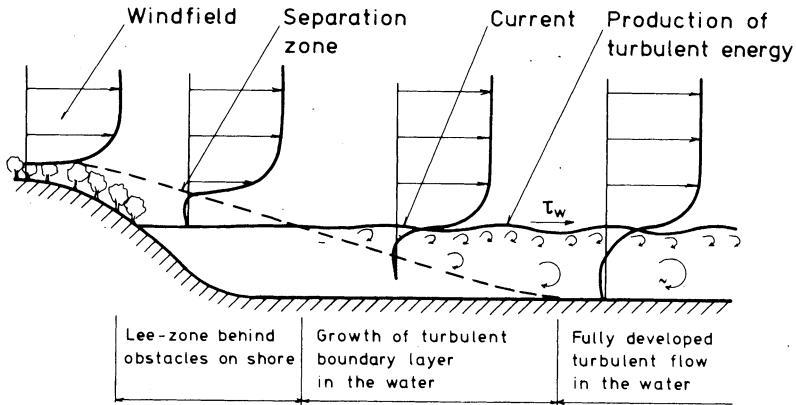

Fig. 1. The development of a Flow Field in a Lake.  $\tau_w$  is the wind shear stress on the surface of the lake.

Turbulence will be generated at the bottom too due to the shear of the wind induced currents, but this turbulence is usually weak compared with that at the surface and is consequently often neglected – (Engelund 1973, Bengtsson 1973).

In small lakes the turbulence level is usually unevenly distributed over the area of the lake because shelter effects of structures on shore will make the windfield uneven and because part of the flow in the lake will be boundary layer flow instead of fully developed turbulent flow – see Fig. 1. The fully developed flow resembles very much that of ordinary channel flow (Bye 1965) with the lake surface corresponding to the channel bottom. Similarly the turbulence in boundary layer regions in the lake resembles that of ordinary wall boundary layers (Larnæs 1976). Hence the major problem of estimating turbulence in lakes is mainly a problem of identifying the different flow zones; but this is a formidable task and the major obstacle for analytical work on lake turbulence. Possible methods of analysis are presented in later sections.

The mixing is not completely dependent on the turbulence level in lakes but also on the presence of strong secondary vortex motions usually denoted Langmuir circulations or windrows. These vortex motions usually appear for strong winds and are characterized by having the axis parallel with the direction of the wind and by having diameters of the same order of magnitude as the waterdepth. The flow is clearly visible on the lake surface on which foam and debris will be assembled in the convergence zones of the flow – see Fig. 2.

The cell flow can be very strong and can be in the order of 1/4 to 1/3 of the directly generated current drift and is consequently very important for the distribution of turbulence in the lake. The mechanisms behind Langmuir flow is not very well understood but they fall into the line of recent discoveries that turbulent flow not only consists of a mean and a turbulent motion but also of a cell

## Mixing Processes in Lakes

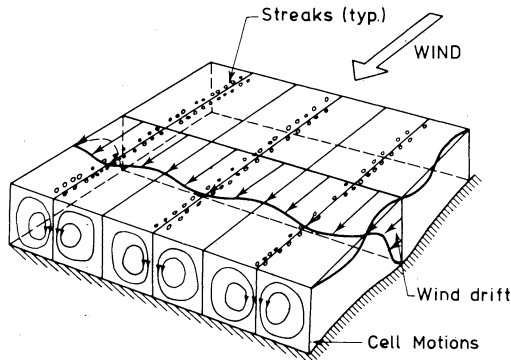

Fig.2. Windrows (Langmuir Circulations).

motion (bursts, Langmuir Flow) – see Laufer (1975). In a special section of the paper a more detailed description of this flow is given.

So far only homogeneous lakes have been considered. In stratified lakes the turbulence is somewhat changed due to density effects caused by the mixing between layers of different density. The turbulence structure is highly dependent on how and where the turbulence is generated. In Fig. 3 different flow situations are shown.

In wind induced circulations (Fig. 3a) the turbulence level and distribution is almost similar to homogeneous lakes with the exception that part of the turbulent energy is used to mix the water of the different layers. The interface is merely acting as a kind of »bottom« for the upper layer – the epilimnion. Langmuir cells may be present in this flow too further promoting the mixing in the epilimnion. In this case the typical cell diameter will be of the same order as the depth of the layer.

In situations with inflow of water of different density (Fig. 3b) the turbulence is generated at the bottom, if the inflowing water is more dense. The turbulence will then have the same structure and magnitude as in wind induced flows or shear flow turbulence. If, on the other hand, the inflowing water does not have any contact with the bottom the turbulence is generated in the interface and has a completely different structure due to the stabilizing effect of the density gradient in the interface. It more resembles turbulence in estuarine flow as fjords or salt water wedges.

Internal seiche motions (Fig. 3c) are more complicated with features resembling both the wind generated flows and the inflow situation. In areas with large velocities the turbulence will be generated in the interface and will have the same structure as in the inflow situation whereas in areas in which the interface is in contact with the bottom more complicated conditions are present.

In the following the state of the art for analysis of the different situations is presented.

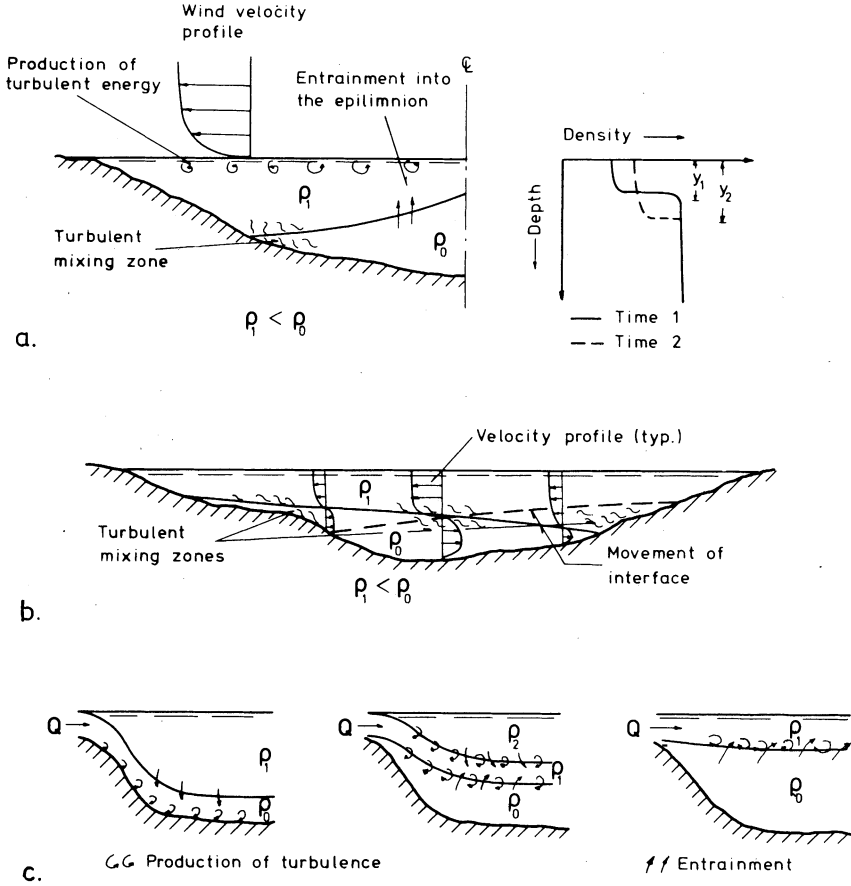

Fig.3. Turbulence and Mixing in Stratified Lakes.  
 a) Windgenerated turbulent surface layer,  
 b) turbulence caused by inflow, and  
 c) turbulence caused by Seiche motions.

### Diffusion and Dispersion in Lakes

Diffusion processes in lakes have been considered for quite a while but still theoretical and practical knowledge is lacking, which is not surprising because even for simple flows as river or channel flow the analysis is not so advanced that diffusion and dispersion can be predicted with sufficient accuracy in all cases. Instead one has to turn to field measurements for normal practical purposes.

Usually diffusive transport is analytically described by the Fickian approach i.e. as.

$$K_j \frac{\partial c}{\partial x_j} \tag{1}$$

in which  $c$  is the concentration of the tracer,  $x_j$  a cartesian coordinate, and  $K_j$  the diffusivity in the  $x_j$ -direction.

Values for diffusivities have been determined by measurements in many different lakes but the scatter is usually very large so no single value or single expression can be used in calculations. One of the effects responsible for the scatter is the presence of windrows which impede the lateral diffusion. Another effect is ill-defined conditions for the diffusion process. In Fig. 4 the different possibilities are shown. A velocity gradient will together with the vertical diffusion increase the dispersion of a tracer in the horizontal direction compared with turbulent diffusion alone, so if no particular knowledge about the velocity distribution is available or if the variation in velocity is not considered this process appears as a normal diffusion around the centroid of the tracer cloud. This less detailed description of a dispersion process is referred to as »Dispersion« for not confusing it with straight turbulent diffusion. The two processes are difficult to distinguish from each other in field tracer studies so when a measured diffusivity for a lake is presented, it is usually a mixture of a diffusion and a dispersion coefficient.

The case of practical interest is usually the diffusion and the dispersion in wind driven currents. Bengtsson (1973) has reported measurements conducted in small Swedish lakes and the results are shown in Fig. 5. It turns out that the longitudinal diffusivity (diffusion parallel with the flow) or – to be more precise – the

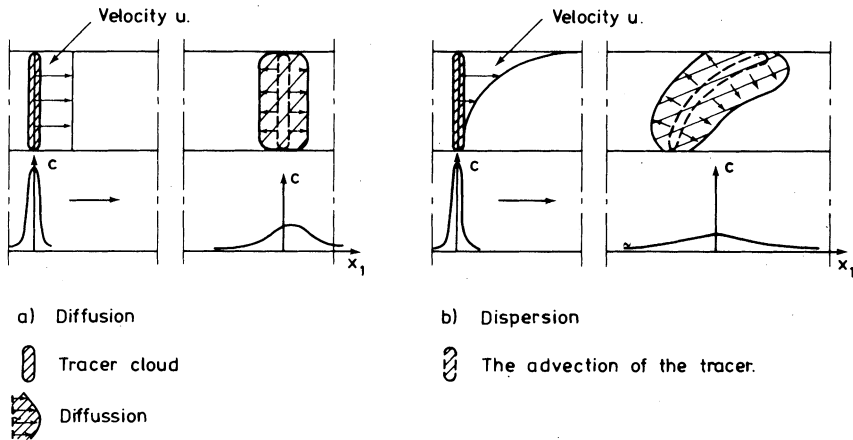

Fig.4. Diffusion and Dispersion in Lakes.

- a) Turbulent diffusion,
- b) combined advection and turbulent diffusion (dispersion).

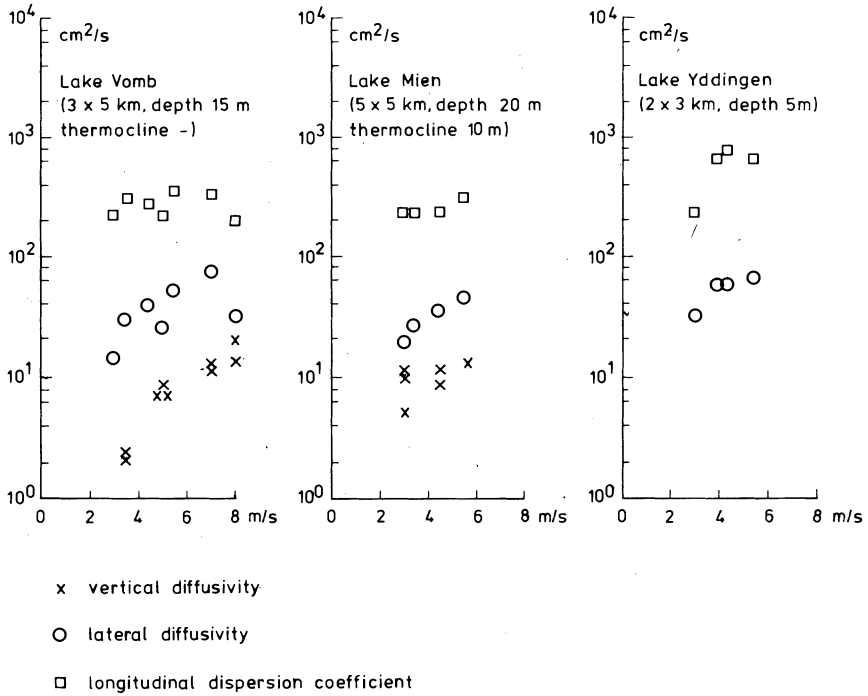

Fig.5. Measured Diffusivities in Lakes. Bengtsson (1973).

longitudinal dispersion coefficient is virtually constant, whereas the transverse and vertical diffusivities are linearly dependent on the wind velocity.

Csanady (1963) has reported the results for diffusion experiments in Lake Huron and found much higher values for the diffusivities than Bengtsson did, and other reported studies give further different values, so it is difficult to recommend or assign particular diffusivities or dispersion coefficients for a given lake. The discrepancy between the results may be due to the different sizes of the lakes considered. The Swedish lakes mentioned, for instance, are rather small without fully developed turbulent flow, whereas Lake Huron is a fresh water sea in which the turbulence definitely is fully developed over the depth. Hence it seems rather impossible to express diffusivities theoretically. The field survey, however, at least indicates that the lateral and vertical diffusivities are given by an expression of the type

$$K = C u_f \delta \tag{2}$$

in which  $u_f = \sqrt{\tau_w / \rho}$  is the frictional velocity,  $\tau_w$  the wind shear stress, and  $\rho$  the density of the water.  $\delta$  is the length scale of the turbulence equal to the water depth in case of fully developed flows (in stratified flows equal to the depth of the upper layer) or equal to the boundary layer thickness for surface boundary layer

## Mixing Processes in Lakes

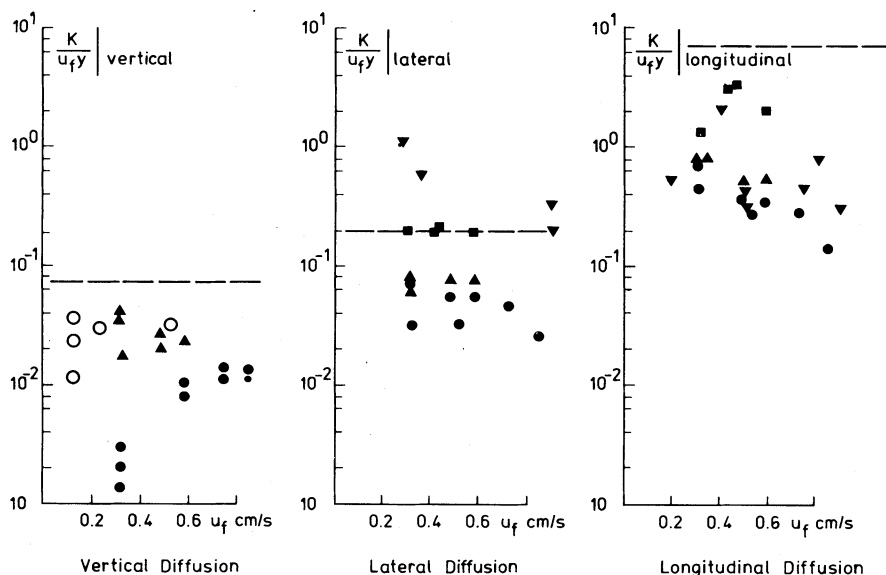

Fig. 6. Non-dimensional diffusivities  $K/u_f y$  versus the frictional velocity  $u_f$  for different lakes. Lake Vomb, Lake Mien, Lake Yddingen, Lake Velen, Lake Huron, and open channel flow.

flows.  $C$  is a constant of proportionality. Values for the longitudinal, the lateral, and the vertical diffusivities are shown in Fig. 6, from which appears that it hardly is a constant. On the other hand the greater part of the scatter is caused by a wrong choice of the turbulent length scale. For instance the lateral diffusivity coefficient for the shallow Lake Yddingen is considerably higher than for the other small lakes and it is very close to the magnitude known from open channel flow thus indicating a fully developed turbulent flow field.

Summarizing the available results for diffusion and dispersion it can be concluded that no reliable analytical expressions for diffusion coefficients in lakes are available so far. Therefore to determine the diffusion characteristics of a lake, field measurements have to be conducted.

### Entrainment in Stratified Lakes

The analysis of the exchange of matter between the different layers in lakes has taken different directions in recent years. Some tend to consider the complete system of equations both for the turbulent motion and for the mean motion (equation of motions) – see Svensson (1977) and (1978). This system of equations is extremely complicated, and the amount of computational work is enormous

even if very large computers are used. Further some aspects of this approach are not resolved. For instance still some doubt is present about the magnitude of the different coefficients in the conservation equations for the turbulence. Due to these difficulties only a limited number of calculations for simple flows has been made so far – Svensson (1978). There is no doubt that this approach is the most accurate one, but for the time being it is not practical in calculations for technical purposes in which more simple formulations are applied, as for instance the equation of motions integrated over the depth of the layer with either empirical or theoretical expressions for the exchange of matter between the layers. Sometimes a more refined variant is used in which the three-dimensional flow inside the different layers is considered, but still special expressions for exchange of matter between the layers have to be applied to close the mathematical formulation. These approaches seem to be the most practical for the moment especially if more complicated situations are considered, and they have been applied with success by Bengtsson (1973) and The Danish Hydraulic Institute (1975). Hence we shall confine ourselves to consider these methods.

The necessary condition for applying this approach is that the expressions for mixing and dilution are correct. The most promising approach and for the moment the most accurate one is suggested by Pedersen (1976, 1977, and 1978) and is based on the budget equation for turbulent energy. It is limited in the respect that it only applies to situations in which one of the layers is turbulent and the adjacent layers non-turbulent (Figs. 7a and 7b), but fortunately these are the more common situations in lake hydraulics. Further it is limited to consider fully developed turbulence and not boundary layer turbulence which means that the results are valid for relatively large lakes and not for small lakes. The implications of this are discussed later.

The basic assumption in Pedersen's approach is that for each type of flow shown in Fig. 7 a relatively constant fraction of the available turbulent energy is transferred to the entrained fluid. The assumption is not obvious, but experiments and measurements in nature confirm it. To deduct the necessary relations the analytical expressions for the contributions to the turbulent energy budget have to be considered. The reader is referred to Fig. 7 for the following calculations.

The amount of turbulent energy transferred to the entrained fluid consists of two parts:

1. The rate of gain in potential energy per area unit

$$\frac{1}{2} \xi \rho g \bar{\Delta} y v_E \quad (3)$$

2. The rate of gain in turbulent kinetic energy per area unit

$$\left( \frac{1}{q} \int_0^y u \bar{e} dx_3 = e_i \right) v_E \quad (4)$$



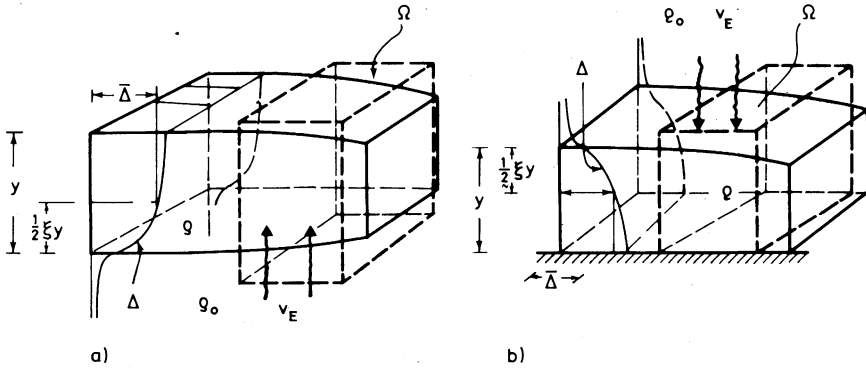

Fig.7. Entrainment in Stratified Lakes. a) Turbulent surface layer, b) turbulent bottom layer.  $\Delta$  is the density deficit.

in which

$x_3$  = vertical coordinate

$\bar{\quad}$  = time average

' = turbulent fluctuation

$v_j$  = velocity component in  $j$  direction

$u$  = horizontal velocity

$v_E$  = rate of entrainment

$$q = \int_0^y u dx_3 = \text{rate of flow per unit width}$$

$y$  = depth of turbulent layer

$\xi$  = a constant depending on the density distribution  
(= 1 for uniform and = 1/3 for triangular distribution)

$g$  = gravitational acceleration

$\rho$  = the density of the turbulent layer

$\rho_0$  = the density of the stagnant layer

$\bar{\Delta} = (\rho_0 - \rho) / \rho_0$

$\bar{e} = \frac{1}{2} \rho v_k' v_k' =$  the turbulent energy per unit mass

$e_i$  = the turbulent energy per unit mass at the interface.

In Eq. (3) the following parameters can be identified:

$\frac{1}{2} \xi y =$  average movement of the entraining fluid into the turbulent layer,

$\rho \bar{\Delta} =$  the density deficit of the entraining mass,

and in Eq. (4) the following parameter is identified

$$\frac{1}{q} \int_0^y u \bar{e} dx_3 = \text{average turbulent kinetic energy in the turbulent layer weighed with the distribution of velocity,}$$

which means that Eq. (4) simply states that the gain in turbulent kinetic energy of the entrained mass is the difference in turbulence level between the turbulent layer and the interface times the volume flux of the entrained fluid.

The gain in energy for the entraining mass has to be taken from the turbulent layer. The sources for the presence of turbulence are the following:

Production of turbulent energy in the volume  $\Omega$  (see Fig. 7)

$$\int_{\Omega} \left( -\tau \frac{\partial u}{\partial x_3} \right) d\Omega = \text{PROD} \tag{5}$$

Storing or removal of turbulent energy by advection

$$-q \frac{\partial}{\partial x_j} \left( \frac{1}{q} \int_0^y u_j \bar{e} dx_3 \right) = \text{STORE} \tag{6}$$

in which

$\tau$  = horizontal shear stress (Reynolds Stress)

$\Omega$  = the volume considered (see Fig. 7).

The ratio between the sink terms, Eqs. (3) and (4), and the source terms, Eqs. (5) and (6), is a measure of the efficiency of the transfer mechanism for turbulent energy to the entraining fluid and is by Pedersen (1976) denoted the Bulk Flux Richardson Number  $R_f^T$



$$R_f^T = \frac{v_E \left[ \frac{1}{2} \xi \rho \bar{\Delta} g y + \frac{1}{q} \int_0^y u \bar{e} dx_3 - e_i \right]}{\text{PROD} + \text{STORE}} \tag{7}$$

This efficiency is of course dependent on the distance between the main generating center of turbulent energy and the interface. If the distance is large (externally generated turbulence) a large proportion of the energy is dissipated before it reaches the interface and is active in the mixing process, so in this case  $R_f^T$  is small. On the other hand  $R_f^T$  is larger when the distance is small (internally generated turbulence). For fully developed turbulent flow over the layer depth the range of  $R_f^T$  is not large.

$$0.05 \leq R_f^T \leq 0.2 \tag{8}$$

in which the lower limit is valid for turbulence generated far from the interface and the upper limit is valid for turbulence generated close to the interface. However, the important thing is that  $R_f^T$  is constant for a particular flow situation which means that as soon as the flow type is identified  $R_f^T$  can be determined from tables as Table 1 or the literature – see Pedersen (1977, 1978). With  $R_f^T$  known Eq. (7) can be used to determine the rate of entrainment  $v_E$ . The equation, however, is

Table 1 - Expressions for entrainment  $v_E$  in different flows. \* The lower limit is valid for externally generated turbulence, the upper limit for internally generated turbulence. (Pedersen 1977, 1978)

	 Wind driven circulation	 Heavy turbulent bottom layer	 Lighter turbulent upper layer
$\int_{\Omega} \tau \frac{\partial u}{\partial x_3} d\Omega$	$\rho A u_f^2; u_f \approx \sqrt{\frac{\tau_w}{\rho}}$	$V \tau (1-\beta); \beta = \frac{u_i}{V} \frac{\tau_i}{\tau_i + \tau_b}$	$\rho g q \tau_{\Delta}^2 \alpha \sqrt{\alpha} \left[ \frac{f}{2} \left( 1 - \frac{u_i}{U} \right) + \frac{v_E}{U} \frac{1}{2} \left( 1 - \frac{u_i}{U} \right)^2 \right]$
$\frac{1}{q} \frac{\partial}{\partial x_j} \left( \frac{1}{q} \int_0^y u_j \bar{e} dx_3 \right)$	$\sim 0$	$\sim 0$	$\sim 0$
$\frac{1}{q} \int_0^y u e dx_3 - e_i$	$\rho B u_f^2; B = 7$	<p>Not known</p>	$B \frac{1}{2} \rho U^2; B \approx 0.13$
$R_f^T$	$0.05$	$0.05 - 0.13^*$	$0.13$
$\xi$	$0.5 - 1$	$0.5 - 1$	$0.5 - 1$
<p>Entrainment rate <math>v_E</math> (general expression)</p>	$\frac{v_E}{u_f} \approx \frac{3}{R_i^* + 15}$	<p>Not known</p>	$\frac{v_E}{u_f} = \frac{R_f^T F_{\Delta}^2}{2 \left( \frac{u_i}{U} \right) \left( 1 - \frac{u_i}{U} \right)}$ $1 + F_{\Delta}^2 \left[ B \left( 1 - \frac{u_i}{U} \right) - R_f^T \left( 1 - \frac{u_i}{U} \right)^2 \right]$
<p><math>v_E</math> for small <math>F_{\Delta}</math> (large <math>R_i^*</math>)</p>	$\frac{v_E}{u_f} \approx \frac{3}{R_i^*}$	$\frac{v_E}{U} = 0.05 - 0.13 \frac{f}{2} F_{\Delta}^{2*}$	$\frac{v_E}{U} = 0.13 \frac{f}{2} F_{\Delta}^2; f \approx 5 \times 10^{-4}$
<p><math>v_E</math> for large <math>F_{\Delta}</math> (small <math>R_i^*</math>)</p>	$\frac{v_E}{u_f} = 0.2$	$\frac{v_E}{U} = f; f \approx 0.075$	$\frac{v_E}{U} = f; f \approx 0.075$

in the present form impractical, because the different terms are not expressed by the usual hydraulic flow parameters as depth, velocity, or frictional coefficient. In Table 1 expressions are given for the parameters together with the final results for the entrainment. Several parameters have been used and they are listed in the following.

- $\tau_w$  = wind shear stress
- $V$  = average velocity in the turbulent layer
- $U$  =  $\sqrt{\alpha} V$
- $\alpha$  =  $(1/V^3) \int_0^y u^3 dx_3$  = velocity distribution coefficient
- $u_i$  = horizontal velocity in the interface
- $\tau_i$  = interfacial shear stress
- $\tau_b$  = bottom shear stress
- $u_f$  =  $\sqrt{\tau_w/\rho}$  = the frictional velocity
- $F_\Delta$  =  $U^2/g\bar{\Delta}y$
- $R_\Delta^*$  =  $g\bar{\Delta}y/u_f^2$

For more details of the entrainment functions the reader is referred to Pedersen (1977, 1978) or Ottesen Hansen (1975). In Fig. 8 the expressions in Table 1 are compared with experiments.

In cases where the flow in lakes is caused by seiche motions – see Fig. 3c – no method of analysis is available so far. An order of magnitude analysis indicates that the mixing due to the velocity difference in the middle of the lake is negligible compared with other mechanisms. On the other hand the mixing in the shallow areas where the interface is in contact with the bottom cannot always be ignored. The problem has been considered for the Baltic by Kullenberg (1977).

So far all the methods are only applicable for fully developed turbulent flow over the entire layer depth. For boundary layer flow in the top of the upper layer only a very small fraction of the turbulent energy is active in the entrainment process, because nearly all turbulence is dissipated in the boundary layer itself. No theory is available for the moment, but experiments by Wu (1975) give some indications of how the entrainment might vary. The author suggests the following rather crude expression (unpublished) based on Wu's experiments (Wu 1973), measurements in Lake Esrum and Lake Velen (Ottesen Hansen (1975), Falkenmark (1971)) and the analysis of the surface boundary layer performed by Larnæs (1976).

$$\frac{v_E}{u_f} = \frac{3(1-20\frac{y}{L})}{R_\Delta^* + 15(1-20\frac{y}{L})} \quad L > 25y \quad (9)$$

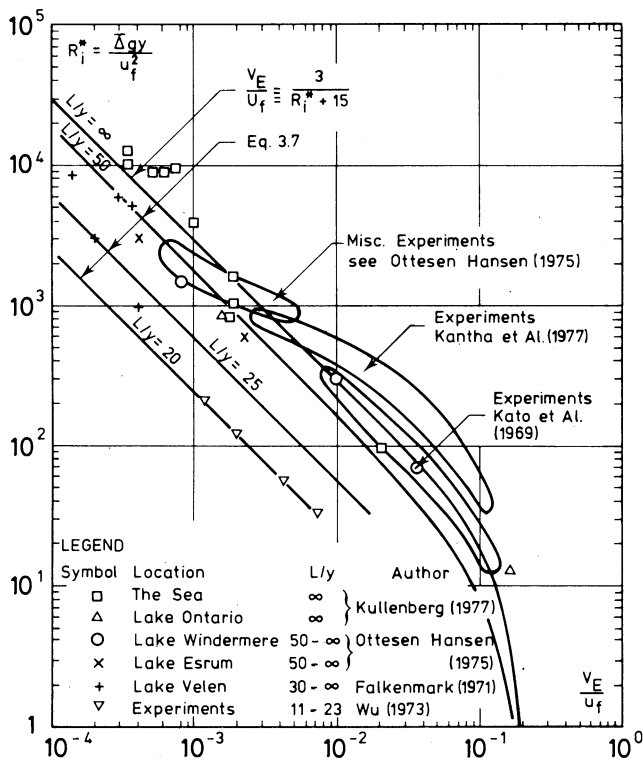

Fig.8. Calculated and Measured Entrainment Rates in Lakes.

$$\frac{v_E}{u_f} = \frac{0.6 \left(\frac{L}{25y}\right)^4}{R_i^* + 3 \left(\frac{L}{25y}\right)^4} \quad L > 25y \quad (9)$$

in which  $L$  is the fetch length for wind across the lake. Eq. (9) are as mentioned very crude expressions and further research in this topic is needed. Examples of Eq. (9) are shown in Fig. 8.

In the deductions so far no attention has been paid to the presence of windrows. Basically the formulae are only valid when windrows are absent, but experience shows that as approximations they might be used even when windrows are present, which means that 5% - 15% of the energy input is always spent on entrainment irrespective of the detailed flow pattern.

## Langmuir Circulations

Langmuir circulations or windrows were briefly described in the introduction and they will now be considered in more detail. They are present during stronger winds as shown in Fig. 9. The results presented are not representative for all areas. For instance it is unusual that windrows occur for windspeeds as low as 3m/sec and further they might not be present at all even for windspeeds exceeding 5-7 m/sec. An Example of this has been observed in a contaminated area near Stockholm where no evidence of windrows were found even for wind speeds well above 5-7 m/sec probably because the wind was unable to break up a strong surface film formed by the pollution. Further strong density gradients just below the surface might inhibit the formation of windrows as shown in Fig. 10.

The cell velocities will depend on the density gradients; but under neutral conditions the downwelling velocities will be typically twice that of the upwelling velocities and they will vary approximately linearly with the wind speed as shown in Fig. 11. Their magnitude is approximately 1/4-1/3 that of the directly wind induced current, which is typically 1/30 of the wind velocity. This current is affected by the cell motions too and is changed from originally being uniformly distributed lateral to the wind to be laterally varying with maxima in the downwelling zones and minima in the upwelling zones, see Fig. 2. The strong cell motions give rise to a large transfer of momentum and matter between the different levels in the lake - a transfer far larger than the direct turbulent diffusion. On the other hand they do not seem to be active in the mixing between the layers in stratified lakes because they seldom reach down to the interface, but they do mix water inside the upper layer which ends up with being virtually uniform in density. It is

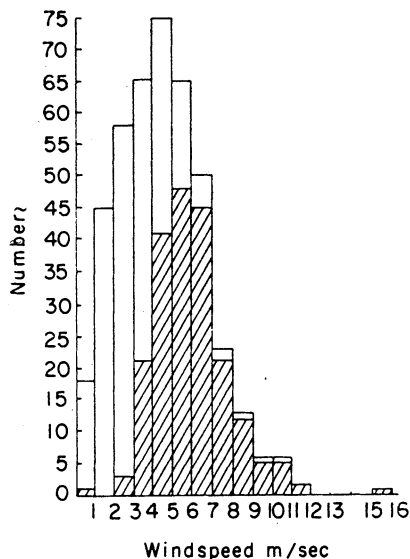

Fig.9. Histogram of windrow occurrence versus windspeed. The total bar gives the number of observations and the hatched bar gives the number for which windrows were observed. (Scott et al. 1969)

## Mixing Processes in Lakes

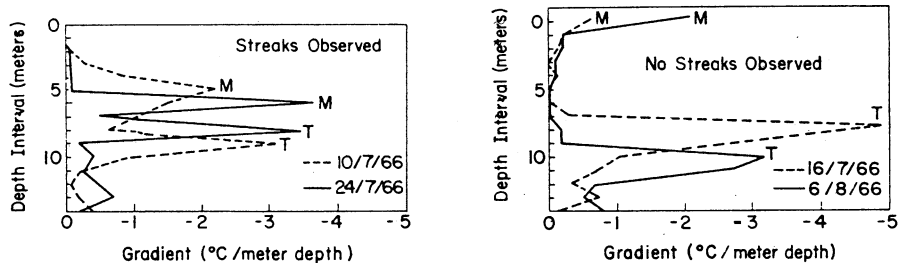

Fig.10. Temperature gradient plotted against depth for two cases each when streaks were and were not present. All dates are for conditions of warning at the surface of Lake George. *T* represents the thermocline and *M* represents the maximum temperature gradient. (Scott et al. 1969).

difficult to assign any particular value to their mixing effect; but for all practical purposes the layer in which they are generated can always be considered completely mixed. As mentioned previously the windrows have decisive effect on the lateral and longitudinal dispersion of matter because the individual cells tend to trap material. How much is trapped and how much is transferred to the neighbouring cells is impossible to predict with the present knowledge.

Summarizing the effect of windrows they will completely mix the layer in which they occur over the depth and they will have a confining effect on the dispersion of tracers.

No satisfactory explanation for the occurrence of Langmuir circulations has been given so far although many hypotheses have been offered. The latest theories advance the idea that they are caused by interaction of some kind between wind-generated waves and the current generated by the wind shear stress. For instance Leibovich (1977) suggests that regular crossing wavetrains symmetrical with respect to the wind direction generate a laterally varying drift current (Stokes drift) which will shear the current generated by the wind shear stress and break it up into cell motions. Hence according to this theory the windrows are a kind of forced motion caused by the wavedrift of crossing wavetrains. The basis of the approach seems rather questionable especially because it demands rather regular wave trains which are definitely not present in

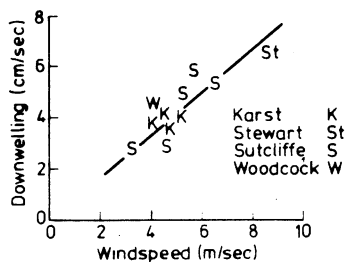

Fig.11. Measured speed of downwelling currents in windrows versus windspeed. Data are from Lake George (Karst and Stewart, unpublished) and from oceanic conditions (Sutcliffe et al. 1963 and Woodcock 1944). From Scott et al. (1969).

confined waters as lakes. On the contrary the power spectra of waves in such areas are known to be very wide.

Other approaches suggest that the windrows are formed by an instability mechanism and not as a forced motion. For instance a mechanism has been proposed in which initially small spanwise periodic irregularities in the current are amplified by the wave drift, which then transfers energy from the basic motion to the lateral motion. The turbulent viscosity will damp this motion but not sufficiently to stop it. Another suggestion is that irregularities in the current field will change the refraction of crossing wavetrains and hereby change the forces exerted by the waves on the current field. In areas with maximum velocities the forces will be largest with the result that the irregularity is amplified and a cell motion is formed.

Some theories do not consider the wave current interaction but instead suggest that differences in »roughness« of the water surface in up- and downwelling zones cause variable wind shear stress which is responsible for the instability. Such theories are ordinarily referred to as film theories. For more details the reader is referred to Scott et al. (1969) and Leibovich (1977).

It is a question whether wave motions have anything to do with the problem at all especially because windrows have been present for waveheights as low as 5 cm. Similar cell structures have been observed in ordinary channel flow by Fisher (1974) and in alluvial streams where they cause the sediment to be transported in streaks and in these flows no wave motions were present so it might just be the same effect which generates the Langmuir circulations.

Summarizing the work done so far on the occurrence and origin of Langmuir flow no conclusion can be drawn. Hence for the moment the only knowledge lies in the existing field surveys.

#### List of notation

$c$	= concentration of tracer
$C$	= a constant
$e$	= turbulent kinetic energy
$e_i$	= turbulent kinetic energy at the interface
$F_{\Delta}$	= The Densimetric Froude Number
$g$	= the gravitational acceleration
$j$	= integer with values 1, 2, 3
$K_j$	= diffusivity or dispersion coefficient in the $x_j$ -direction
$L$	= fetch length for wind across a lake
$q$	= rate of flow per unit width
$R_f^T$	= Bulk Flux Richardson Number



## Mixing Processes in Lakes

$R_z^*$	= The Richardson Number
$u$	= a horizontal velocity
$u_f$	= the frictional velocity
$U$	= $\sqrt{\alpha} V$
$v_j$	= velocity in the $j$ -direction
$v_E$	= entrainment velocity
$V$	= average velocity
$x_j$	= coordinates $j = 1, 2, 3$
$y$	= depth of the lake or a turbulent layer
$\alpha$	= a velocity distribution coefficient
$\delta$	= the turbulent length scale
$\Delta$	= non-dimensional mass-deficit
$\xi$	= mass distribution coefficient
$\rho$	= density of water
$\rho_0$	= reference density
$\tau$	= a shear stress
$\tau_w$	= wind shear stress on lake surface
$\Omega$	= a volume
$-$	= time average
$'$	= turbulent fluctuation

## References

- Bengtsson, L. (1973) Conclusions about turbulent exchange coefficients from model studies. IAHS Publication no. 109 pp. 306-312. Proceedings of the Helsinki Symposium July 1973.
- Bengtsson, L. (1973) Mathematical models of wind-induced circulations in a lake. IAHS Publication no. 109 pp. 313-320. Proceedings of the Helsinki Symposium July 1973.
- Bye, J.A.T. (1965) Wind-driven circulation in unstratified lakes. *Limnol. Oceanogr.* 10, 451-458.
- Csanady, G.T. (1963) Turbulent diffusion in Lake Huron. *Journal of Fluid Mech.* Vol. 17, part 3, 360-385.
- Danish Hydraulic Institute (1977) Belt Project. Mathematical models of the Great Belt and the Sound. Final report, Danish Hydraulic Institute, DK-2970 Hørsholm.
- Engelund, F. (1973) Steady wind set-up in prismatic lakes. Progress report no. 28, April 1973, Institute of Hydrodynamic Engineering. The Technical University of Denmark.
- Falkenmark, M. (1971) Dynamic studies in Lake Velen. International Hydrological Decade Sweden, Report 31. Swedish Nature and Science Research Council.
- Fischer, H.B. (1973) A possible explanation for Nordin, Mc Quivey, and Mejia's observation of the Hurst Phenomenon. *Water Resources Research* Vol. 9, No. 2, 492-493.
- Kantha, L.H., Phillips, O.M., and Azad, R.S. (1977) On turbulent Entrainment at a stable density interface. *Journal of Fluid Mech.* Vol 79, part 4, 753-769.

- Kato, H., and Phillips, O.M. (1969) On the penetration of a turbulent layer into stratified fluid. *Journal of Fluid Mech.* Vol 37 part 4, 643-655.
- Kullenberg, G.E.B. (1977). Observations of the mixing in the Baltic thermo- and halocline layers. *Tellus* (1977), 29, 572-587.
- Larnæs, G. (1976) Formations of wind waves. Series Paper no. 10. Institute of Hydrodynamics and Hydraulic Engineering. The Technical University of Denmark.
- Laufer, J. (1975) New trends in experimental turbulence research. *Annual Review of Fluid Mechanics*, Vol 7, 307-327.
- Leibovich, S. (1977) On the evolution of the system of wind drift currents and Langmuir circulations in the ocean. Part 2. Structure of the Langmuir vortices. *Journal of Fluid Mech.* Vol 80, part 3, 481-509.
- Ottesen Hansen, N.-E. (1975) Entrainment in two-layered flows. Series Paper no. 7. Institute of Hydrodynamics and Hydraulic Engineering. Technical University of Denmark.
- Ottesen Hansen, N.-E. (1975) Effect of wind stress on stratified deep lake. *A.S.C.E. Vol. 101 No. HY 8*, 1037-1051.
- Pedersen, Fl. Bo (1976) The Flux Richardson Number and the entrainment function. Progress Report 39, Aug. 1976. Institute of Hydrodynamics and Hydraulic Engineering. Technical University of Denmark.
- Pedersen, Fl. Bo (1977) The Bulk Flux Richardson Number applied on turbulent entrainment at a stable density interface. Progress Report 43. Aug. 1977. Institute of Hydrodynamics and Hydraulic Engineering. Technical University of Denmark.
- Pedersen, Fl. Bo (1978) On dense bottom Currents in the Baltic deep water. *Nordic Hydrology*, Vol. 8, No. 5, 297-316.
- Pedersen, Fl. Bo (1978) The entrainment function for gradually varying two-layered stratified flow part 1. Progress Report 45. April 1978, Institute of Hydrodynamics and Hydraulic Engineering. Technical University of Denmark.
- Scott, J.T., Glenn, E. Myer, Steward, R., and Walther, E.G. (1969) On the mechanism of Langmuir circulations and their role in Epilimnion mixing. *Limnology and Oceanography* 14, 493-503.
- Svensson, U. (1977) A complete derivation of a turbulence model for environmental fluid flows. Report No. 3007 Department of Water Resources Engineering, Lund, Institute of Technology, University of Lund, Sweden.
- Svensson, U. (1978) Examination of the summer Stratification. *Nordic Hydrology*, Vol. 9, No. 2.
- Wu, J. (1973) Wind-induced turbulent entrainment across a stable density interface. *Journal of Fluid Mech.* 61, part 2, 275-287.

Received: 6th March, 1978

**Address:**

Institute of hydrodynamics and hydraulic engineering,  
ISVA, Technical University of Denmark,  
Bldg. 115,  
DK-2800, Lyngby, Denmark.