

## Gene-expression programming to predict pier scour depth using laboratory data

Mujahid Khan, H. Md. Azamathulla and M. Tufail

### ABSTRACT

Prediction of bridge pier scour depth is essential for safe and economical bridge design. Keeping in mind the complex nature of bridge scour phenomenon, there is a need to properly address the methods and techniques used to predict bridge pier scour. Up to the present, extensive research has been carried out for pier scour depth prediction. Different modeling techniques have been applied to achieve better prediction. This paper presents a new soft computing technique called gene-expression programming (GEP) for pier scour depth prediction using laboratory data. A functional relationship has been established using GEP and its performance is compared with other artificial intelligence (AI)-based techniques such as artificial neural networks (ANNs) and conventional regression-based techniques. Laboratory data containing 529 datasets was divided into calibration and validation sets. The performance of GEP was found to be highly satisfactory and encouraging when compared to regression equations but was slightly inferior to ANN. This slightly inferior performance of GEP compared to ANN is offset by its capability to provide compact and explicit mathematical expression for bridge scour. This advantage of GEP over ANN is the main motivation for this work. The resulting GEP models will add to the existing literature of AI-based inductive models for bridge scour modeling.

**Key words** | artificial intelligence, artificial neural networks, data-driven models, gene-expression programming, pier scour, regression models

**Mujahid Khan** (corresponding author)  
**M. Tufail**  
 Department of Civil Engineering,  
 University of Engineering & Technology,  
 Peshawar,  
 Pakistan  
 E-mail: [mujahidkhan@nwfpuet.edu.pk](mailto:mujahidkhan@nwfpuet.edu.pk)

**H. Md. Azamathulla**  
 REDAC,  
 Universiti Sains Malaysia,  
 Penang,  
 Malaysia

### NOTATION

$d_{50}$	mean sediment diameter
$g$	gravitational acceleration
$y$	approaching flow depth
$b$	pier width
$F_r$	Froude number
$V$	approaching flow velocity
$R^2$	coefficient of determination
AAE	average absolute error
RMSE	root mean square error
$d_s$	bridge pier scour depth
$V_c$	critical velocity
$F_{rc} = V_c / \sqrt{(g * h)}$	critical Froude number
$d_s / y$	relative scour depth

doi: 10.2166/hydro.2011.008

### INTRODUCTION

The pier, an essential component of a bridge, provides an obstruction to the flow of water causing removal of the bed material from around the pier and abutment. This phenomenon is called scouring. Bridge scour is the result of the erosive action of flowing water, excavating and carrying away material from the bed and banks of streams and from around the piers and abutments of bridges (Richardson & Davies 1995). Scour is a complex phenomenon and accurate prediction of scour depth is thus a difficult task given the numerous factors that contribute to it. Bridge scour is one of the biggest causes of bridge failure and a major factor that contributes to the total construction and maintenance costs of bridges. Under-prediction of bridge scour designs

can lead to costly bridge failures associated with a possible loss of human lives. Similarly, over-prediction can result in wasting millions of dollars on a single bridge (Florida Department of Transportation Manual 2005). Acknowledging the problems posed by bridge failures due to scour-related processes, the subject of bridge scour prediction needs proper attention and there is a need to enhance the current research in this area, including tools and techniques to accurately predict bridge scour. Enhancing research in these areas can lead to safe, economical and technically sound bridge pier design (Azamathulla *et al.* 2010).

In the past, many investigators have attempted to develop conservative, analytical, semi-empirical or empirical equations based on an understanding of the mechanics of scour, dimensional analysis and data correlation of laboratory experiments (Breusers *et al.* 1977; Melville & Sutherland 1988; Richardson & Davis 1995; Melville 1997; Coleman & Melville 2001; Muzzammil & Gangadharaiah 2003; Muzzammil & Ayyub 2009). Other recent work in data-driven modeling include that of Mohammad *et al.* (2005) which reported that the Laursen & Toch (1956) and the Colorado State University (Richardson & Davis 1995) formulae give reasonable estimates, whilst the Melville & Sutherland (1988) and Jain & Fischer (1979) formulae over-predict pier scour based on the comparison of some bridge pier scour formulae using field and laboratory data.

As a result we have a number of empirical equations based on the principles of conventional data-driven modeling techniques such as regression analysis of available field data as well as laboratory data. The complexity of bridge scour processes requires that such models be based on datasets that include all relevant decision variables that contribute to the process of bridge scour. Further, there is also then a need that the modeling techniques used to derive empirical models for bridge scour are effective and accurate, and can capture the cause-and-effect relationship of the input and output variables involved in the process. In summary, the two major factors affecting the advancement of bridge scour prediction methods include (1) availability of the data (field-collected or laboratory-collected) covering all relevant parameters and (2) availability and application of effective and efficient modeling tools that can be applied to the available data to generate accurate bridge scour prediction models for use by designers

in bridge design. Use of unreliable data and/or modeling methodology can lead to models that may not properly and accurately predict bridge scour depth. It is also important to calibrate the existing models available in literature with reliable data. Yanmaz (2003) concluded that the calibration of the scour prediction models with field data is restricted mainly due to the lack of relevant size and precision of the field data.

To address the relevant needs of research in the field of bridge scour modeling, recent research initiatives are exploring ways to either enhance the data collection efforts by collecting reliable field and laboratory datasets and/or to enhance the available modeling tools used to fit empirical models to available datasets. In particular, recent research has made good advances in the development of modern data-driven modeling techniques such as those based on artificial intelligence (AI) techniques. Such techniques have found excellent applications in the field of hydraulic and water resources engineering and have provided more effective model structures when compared to more conventional techniques such as those based on multiple linear regression (MLR). Recent literature reveals that AI-based inductive modeling techniques are increasingly being used to model complex response functions such as bridge scour analysis due to their powerful and nonlinear model structures and capability to better capture the cause-and-effect relationship of such complex processes. Such AI-based techniques include artificial neural networks (ANNs), adaptive neuro-fuzzy inference system (ANFIS), genetic algorithms (GA) and genetic programming (GP) (ASCE Task Committee 2000a, b; Azamathulla *et al.* 2005, 2010; Bateni *et al.* 2007; Lee *et al.* 2007) and have been found to provide favorable results in modeling complex response functions including bridge scour depth based on available data collected either in the field or laboratory. ANNs have been reported to provide reasonably good solutions for hydraulic engineering problems in cases of highly nonlinear and complex response functions (Azamathulla *et al.* 2005, 2008).

More recently a new technique called gene-expression programming (GEP) was developed which is an extension of GP (Koza 1999). It is a search technique that evolves computer programs (mathematical expressions, decision trees and logical expressions). The computer programs of GEP

are all encoded in linear chromosomes, which are then expressed or translated into expression trees (ETs). ETs are sophisticated computer programs that are usually evolved to solve a particular problem, and are selected according to their fitness at solving that problem. From these trees, the corresponding empirical expressions can be derived. It has been found to give reasonably good prediction for sediment load (Ab Ghani et al. 2010).

The main objective and motivation of this study is to further enhance the available data-driven modeling tools for predicting bridge scour by developing GEP-based models for pier scour prediction utilizing available laboratory data and then comparing its performance with ANN and regression-based models. Further, another objective is to evaluate the utility of GEP-based models for bridge scour prediction with the aim to provide compact, explicit empirical expression that can be used for predicting bridge scour. While ANN-based models are powerful in that they provide good fit to the data used in model training and validation, often such models do not result in compact and explicit equations for use by designers. The resulting ANN-based model structure is often a long expression consisting of activation functions with variable complexity, depending on the number of hidden layers used in the model structure. Lastly, this work provides an opportunity to combine a range of laboratory data used by various researchers in the past to provide a diversified dataset that can be used in the development of data-driven bridge scour models. The resulting dataset collected and used in this work covers a broad spectrum and variation of the related model input decision variables.

## LOCAL SCOUR AROUND A BRIDGE PIER

The equilibrium local scour depth ( $d_s$ ) around a circular pier (Figure 1(a)) over a bed of uniform and non-cohesive sediments depends on numerous decision variables including flow, sediment characteristics and pier geometry (Figure 1(b)). Local scour at piers is a function of the following parameters:

$$d_{se} = f(V, y, g, d_{50}, b, L, \sigma) \quad (1)$$

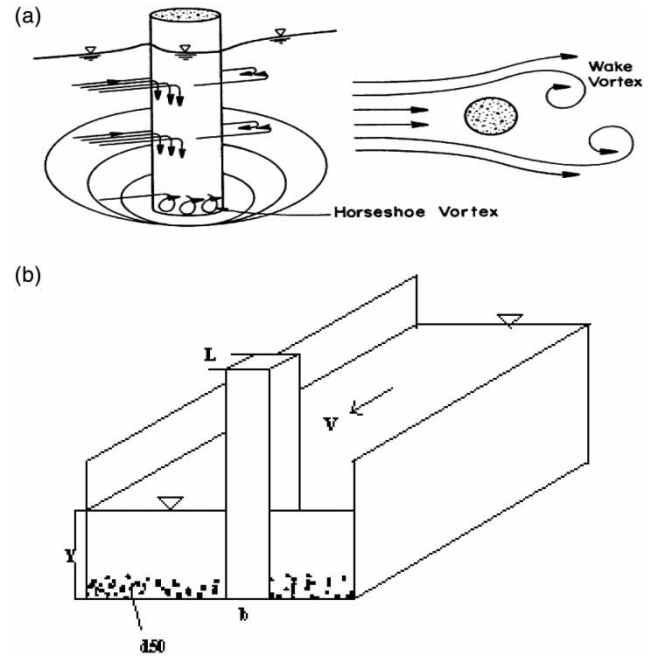

**Figure 1** | (a) Schematic representation of scour at cylindrical pier (US Department of Transportation 2001). (b) Different parameters affecting scour depth.

where  $V$  = approach velocity,  $y$  = approach flow depth,  $g$  = acceleration due to gravity,  $d_{50}$  = particle mean diameter,  $b$  = pier width,  $L$  = length of pier and  $\sigma$  = grain size distribution. In this study only pier width ( $b$ ), flow velocity ( $V$ ), flow depth ( $y$ ), mean diameter of bed material ( $d_{50}$ ) and acceleration due to gravity ( $g$ ) were used in the model development. The current study will utilize available laboratory data for all such relevant variables used by researchers in the past. Table 1 summarizes the ranges of these variables in the available laboratory data collected from past literature.

The five dimensional parameters selected for use in the current study are reduced to three non-dimensional parameters as follows:

$$\frac{d_s}{y} = f\left(F_r, \frac{b}{y}, \frac{d_{50}}{y}\right) \quad (2)$$

where  $F_r$  is the Froude number. The above three parameters were used for the development of the ANN and GEP models.

**Table 1** | Ranges of laboratory data

Variables	Minimum		Median		Maximum	
	Training	Testing	Training	Testing	Training	Testing
$b$ (m)	0.010	0.025	0.067	0.070	0.700	0.910
$V$ (m/s)	0.110	0.204	0.316	0.410	2.478	1.290
$y$ (m)	0.010	0.050	0.115	0.200	0.600	1.900
$d_{50}$ (m)	0.000006	0.0000006	0.00096	0.00095	0.0169	0.0030
$d_s$ (m)	0.0000	0.000	0.079	0.124	0.321	1.390
$F_r$	0.0712	0.118	0.285	0.288	2.146	0.980
$d_{50}/y$	0.00000	0.001	0.005	0.010	0.188	0.099
$b/y$	0.0475	0.080	0.469	0.548	21.053	5.353
$d_s/y$	0.0000	0.020	0.581	0.640	5.056	4.74

## DEVELOPMENT OF DATA-DRIVEN MODELS FOR BRIDGE PIER SCOUR DEPTH USING LABORATORY DATA

The work described in this paper presents the development of data-driven models using different techniques for bridge scour prediction using laboratory data collected by various researchers. In the current study, three different types of model structures will be used in the development of data-driven models namely (1) regression, (2) ANN and (3) GEP. Regression-based models are evaluated for the purpose of comparison with the other two artificial intelligence (AI)-based inductive models and these consist of (1) the use of regression-based empirical formulae developed for bridge scour prediction developed by previous researchers and (2) the development of new MLR models that are trained and tested on the available laboratory data. As described above, the main motivation of this paper is to advance the data-driven modeling techniques by investigating more robust and efficient techniques that can result in more accurate and effective data-driven models for bridge scour prediction. In this regard, the current work will investigate the utility of two AI-based models (ANN and GEP) for bridge scour prediction and compare their performance to traditional regression-based models.

The laboratory data used in this work consist of 529 datasets previously used by researchers in the development of similar models using various techniques. The three

types of models developed and evaluated in this work are described in the following sections.

## TRADITIONAL REGRESSION MODELS

Bridge pier scour is dependent on a number of factors as discussed above. Most of the pier scour prediction formulae available in the literature are developed based on conventional regression methods. Most of these models overpredict the pier scour, resulting in an uneconomical bridge foundation design. Under the current practice of bridge scour prediction, one either refers to one of the already available empirical equations for a particular application, or if sufficient new data is available for the particular application (field or laboratory), then new empirical models are or can be developed by fitting the available data to conventional empirical model structures such as regression-based techniques. In the current study, both these approaches are evaluated by first (1) selecting empirical equations already developed by previous researchers and comparing its performance on the validation (testing) dataset to other models or techniques and second by (2) developing new MLR-based empirical models by utilizing the laboratory data used in the study and subsequent training and testing on the corresponding datasets. This way, one can evaluate the relative performance of empirical equations already developed by other researchers to the ones developed specifically for the data (529 laboratory datasets). The

performance of both types of regression-based models is then compared to that of the more complex and nonlinear AI-based models including ANNs and GEP-based models.

### Regression models previously developed by other researchers

For the regression models and equations already developed by other researchers, the current study will evaluate the performance of three existing models (equations) including (1) the Jain & Fischer equation (1979), (2) the revised Shen II equation (1971) and (3) the revised Hancu equation (1971). The reason for specifically selecting these formulae for comparison is the fact that all of these are based on conventional regression techniques and two of these had been recently revisited and revised accordingly for predicting bridge scour. Ab Ghani *et al.* (2010) revised 11 different pier scour equations using multiple linear regression techniques including the Shen II and Hancu equations. The existing regression-based models evaluated in this study are presented below.

#### Jain & Fischer (1979) equations

Jain & Fischer (1979) developed a set of equations shown below for clear water and live bed scour conditions based on laboratory experiments:

$$d_{se} = 1.84 * b * \left(\frac{h}{b}\right)^{0.3} * F_{rc}^{0.25} \quad (3a)$$

valid for  $F_r - F_{rc} < 0$  in clear water conditions

$$d_{se} = 2.0 * b * \left(\frac{h}{b}\right)^{0.5} * (F_r - F_{rc})^{0.25} \quad (3b)$$

valid for  $F_r - F_{rc} \leq 0.2$  in live bed conditions

where  $d_{se}$  = equilibrium scour depth,  $b$  = pier width,  $h$  = flow depth,  $F_r$  = Froude number,  $F_{rc}$  = critical Froude number given by  $F_{rc} = V_c / \sqrt{(g * h)}$ .

For  $0 < (F_r - F_{rc}) < 0.2$  the largest value obtained from Equations (3a) or (3b) is to be taken.

These formulae were recently used by Mohammad *et al.* (2005) for comparison with other model structures and

techniques and it was found that they over-predict the local scour depth. Equations (3a) and (3b) accordingly are used as one of the regression-based equations for comparison with the new MLR, ANN and GEP-based models.

#### Revised Shen II equation

The original Shen II equation developed by Shen (1971) is as given below:

$$\frac{d_s}{b} = \beta_0 * (F_r)^{\beta_1} \quad (4a)$$

This equation was revised by Ab Ghani *et al.* (2010) by finding the numerical values of the coefficients  $\beta_0$  and  $\beta_1$  by using the least-squares method, which results in the following equation:

$$\frac{d_s}{b} = 0.716 * (F_r)^{0.192} \quad (4b)$$

where  $d_s$  is the scour depth,  $b$  is pier width and  $F_r$  is the Froude number. Accordingly, Equation (4b) above is the revised Shen II equation and is the one used in this work for comparison with the new MLR, ANN and GEP models.

#### Revised Hancu equation

The original Hancu equation developed by Hancu (1971) is as given below:

$$\frac{d_s}{b} = \beta_0 * \left(\frac{V^2}{(g * b)}\right)^{\beta_1} \quad (5a)$$

This equation was also revised by Ab Ghani *et al.* (2010) by finding the numerical values of the coefficients  $\beta_0$  and  $\beta_1$  by using the least-squares method, which results in the following equation:

$$\frac{d_s}{b} = 0.176 * \left(\frac{V^2}{(g * b)}\right)^{0.088} \quad (5b)$$

Accordingly, Equation (5b) above is the revised Hancu equation and is the one used in this work for comparison with the new MLR, ANN and GEP models.

Note that for the above three existing regression equations (Jain & Fisher equation, revised Shen II equation and revised Hancu equation), model training is not performed in the current study since these were already developed and trained previously. These equations are only utilized in model validation (testing) and their testing results are compared to the new MLR, ANN, and GEP-based models.

### New MLR-based data-driven models

In addition to the three previously developed and existing regression equations described above, new MLR-based models are developed utilizing the 529 data points. MLR-based data-driven models were developed for predicting pier scour depth based on three model inputs including  $F_r$ ,  $b/y$  and  $d_{50}/y$ . The form of the MLR model is given in Equation (6):

$$BS = a_0 + a_1 \frac{b}{y} + a_2 \frac{d_{50}}{y} + a_3 F_r \quad (6)$$

where  $a_0$ ,  $a_1$  and  $a_2$  are regression coefficients,  $b/y$  (relative pier diameter),  $d_{50}/y$  (relative sediment size) and  $F_r$  (Froude's number) are the independent decision variables in the regression model and BS (relative bridge scour) is the dependent variable to be predicted by the model. The results of the MLR-based modeling exercise resulted in the following equation for the prediction of bridge pier scour:

$$\frac{d_s}{y} = 0.18945 + 0.466 \frac{b}{y} + 0.0975 \frac{d_{50}}{y} + 0.533 F_r \quad (7)$$

### AI-BASED DATA-DRIVEN MODELS FOR BRIDGE SCOUR

An inductive or empirical model is based on data and is often used to predict, not explain, a system. The equations and calibrations of inductive models rely (more directly) on field or laboratory data, or empirical observations

(Tufail *et al.* 2008). Numerous empirical formulae or inductive models based on regression analysis have been discussed above to estimate scour depth at bridge piers under different conditions using laboratory data. Most of the regression-based models developed and applied for bridge scour predictions, including the ones described above, tend to overestimate the scour depth. This is because such conventional models are too simple (linear) in their structure, thereby failing to accurately predict the influence of all relevant input parameters on scour depth. Accordingly, such models often fail to accurately model the cause-and-effect relationship between inputs and output. Recognizing these difficulties and the importance of improving prediction capabilities, this paper looked into the utility of more complex model structures for developing inductive models for bridge scour prediction, such as those based on artificial intelligence techniques. In particular, this paper will investigate the utility of two AI-based inductive models namely ANNs and a relatively new GP-based technique called gene-expression programming (GEP) for predicting bridge scour depth using laboratory data.

### ARTIFICIAL NEURAL NETWORK MODEL

Artificial neural network (ANN) is a mathematical model constructed so as to approximate the basic functions associated with a biological neuron. In other words, it is a digital model of the human brain and it imitates the way a human brain works. It consists of a highly interconnected network of several simple processing units called neurons. ANNs are constructed by creating connections between a set of digital processing elements (the computer equivalent of neurons) that consists of an input layer of elements or neurons, hidden layers of neurons and an output layer of neurons. The organization and weights of these connecting elements are adjusted through a process of 'training' in order to calibrate the model. A wealth of literature on the architecture of neural networks, training and testing can be found elsewhere (e.g. Zurada 1992). Concepts involved behind such training schemes are also outlined in the ASCE Task Committee (2000a, b). The number of hidden layers varies based on the complexity of the model. The number of hidden layers and the number of neurons in

each hidden layer are often varied to optimize the performance of the final model.

ANN-based models, such as the popular multi-layer feed-forward networks, have frequently been used to approximate the response of a particular system by training with available data. ANN models are often referred to as 'black box models' as they are not primarily used to produce empirical equations to represent a process, but are rather used to produce outputs according to inputs received by the model. Such models generally require considerable data for training and thus may not be favorable for applications where the objective is to obtain a simple, easy to use and functionally compact approximation. ANNs have been successfully used in modeling of water resources systems in areas such as rainfall-runoff modeling, reservoir operations, etc. (Babovic & Bojkov 2001). ANNs have also been applied extensively in the past decade in the field of hydrology for estimation and forecasting of hydrologic variables (ASCE 2000a, b; Govindaraju & Rao 2000). Jeng *et al.* (2006) reported that the neural network approach has been applied to many branches of science, including aspects of hydraulic and environmental engineering. Some of the earliest applications of neural network models in hydrology and water resources engineering were reported by Daniel (1991). Some earliest applications of ANN include Karunanithi *et al.* (1994), Grubert (1995), Minns (1998), Coppola *et al.* (2003), Nagy *et al.* (2002), Jain & Prasad (2003) and Sudheer & Jain (2003). Recent applications of ANN in the field of hydraulic engineering are Azamathulla *et al.* (2005, 2008), Jeng *et al.* (2006), Bateni *et al.* (2007), Lee *et al.* (2007) and Muzzammil & Ayyub (2009). Also, Kambekar & Deo (2003) estimated scour depth around a group of piles using neural network models.

As previously indicated, laboratory data was used in the development of inductive models in this study. The data was collected from different studies in the literature including Chabert & Engeldinger (1956), Hancu (1971), Jain & Fischer (1979), Ettema (1980), Chee (1982), Chiew (1984), Yanmaz & Altinbilek (1991), Kothiyari *et al.* (1992), Graf (1995), Melville (1997), Ettema *et al.* (1998), Melville & Chiew (1999), Ting *et al.* (2001), Oliveto & Hager (2002), Lauchlan & Melville (2001), Mia & Nago (2003), Molinas (2003), Sheppard *et al.* (2004) and Mohammad *et al.* (2005). Out of the total 529 datasets 398 (75%) were used for training of the ANN

model while the remaining 131 (25%) were used for its validation. There were three input variables ( $F_r$ ,  $d_{50}/y$ ,  $b/y$ ) and one output variable, i.e.  $d_s/y$ .

In this study Neuro sort software was used for development of ANN models (Lingireddy *et al.* 2003). A simple feed-forward-type network was trained using the back-propagation technique. The data used in the model development was normalized before it was fed to the software for subsequent training and validation. The neural network training was done using a standard error, supervised back-propagation training algorithm (Rumelhart & McClelland 1986; Haykin 1994) with a learning rate of 0.1 and momentum factor of 0.4. The learning rate, also known as the step size, is a factor that determines the amount by which the connection weight is changed according to error gradient information. The momentum parameter governs the weight change in the current iteration of the algorithm due to change in the previous iteration. The values used for the learning rate and momentum, 0.1 and 0.4 respectively, were obtained by the trial-and-error method (Haykin 1994; Maier & Dandy 1998). The back-propagation algorithm (Rumelhart & McClelland 1986) used in the current study employs a gradient descent technique to adopt weights in the ANN structure to minimize the mean squared difference between the ANN output and desired (actual) output. The number of neurons in the hidden layer were varied between 3 (number of model inputs) to a maximum of 6. In all cases, the optimal results were obtained by using three neurons in the hidden layer. The model results did not vary significantly for ANN models with the number of neurons in the hidden layer ranging from 3 to 6. In the hidden and output layers, a sigmoidal activation function was used for modeling the transformation of values across the layers as given in Equation (8):

$$f(x) = \frac{1}{1 + e^{-x}} \quad (8)$$

The initial weights used in the ANN model were generated randomly to values close to zero. The maximum number of epochs (iterations) in model training was set to 20,000 for all ANN models developed in this study. The training epochs were decided based on trials by observing ANN training and validation (testing) results together to locate the optimal termination. Such a simultaneous

monitoring of training and testing model errors is beneficial as it avoids over-training of the models. The statistical measures used by [Mohammad \*et al.\* \(2005\)](#) and [Azamathulla \*et al.\* \(2010\)](#), i.e. root mean square error (RMSE), mean absolute error (MAE) and coefficient of determination ( $R^2$ ) were evaluated as the measure of performance of the AI-based inductive models in this study.

## OVERVIEW OF GENE-EXPRESSION PROGRAMMING

Gene-expression programming (GEP) is a new evolutionary AI-based technique developed by Candida Ferreira in 1999. This technique is an extension of genetic programming (GP) developed by [Koza \(1999\)](#). The genome is encoded as linear chromosomes of fixed length just like in genetic algorithms (GA), which are then expressed as a phenotype in the form of expression trees by GEP. GEP combines the advantages of both its predecessors, GA and GP, while eliminating some of the limitations of these two techniques. GEP is a fully fledged genotype/phenotype system where both are dealt with separately. As a consequence of this, the fully fledged genotype/phenotype system of GEP surpasses the old GP system by a factor of 100–60,000 ([Ferreira 2000a, b](#)).

In GEP, just like the other evolutionary methods, the process starts from the random generation of an initial population. It consists of individual chromosomes of fixed length. The chromosome may contain one or more than one genes. Each individual chromosome of the initial population is then evaluated and their fitness is computed using a fitness function based on the mean square error. These chromosomes are then selected based on the fitness value using a roulette wheel selection process. The fitter the chromosomes, the better the chances of selection into the next generation. After selection these are reproduced with some modifications done by genetic operators. In GEP, genetic operators including mutation, inversion, transposition and recombination are used for modification. Mutation is found to be the most effective genetic operator and in most cases is found to be the only operator used to modify the chromosomes. The new individuals are then subjected to the same process of modification and the process continues until the maximum number of generations is reached or the required accuracy is achieved ([Ferreira](#)

[2000a, b](#)). In the GEP system, several of these genetic operators used for genetic modification of chromosomes are explained as follows ([Ferreira 2006](#)):

*Mutation.* It is the most important and influential of all the operators. In GEP modeling, mutation can take place at any position in a genome. However, the structural organization of the chromosomes must remain the same, i.e. in the head of a gene, a function can be replaced by either another function or a terminal but, in the tail of a gene, terminals can only change into other terminals as there is no function in the tail. In this way all the new individuals produced by mutation are structurally correct programs.

*Inversion.* In this operator a sequence within the head of gene is selected and is inverted. It randomly chooses the chromosome, the gene to be modified and the start and terminal points of the portion of the head to be inverted.

*Insertion sequence (IS) transposition.* The IS elements are short portions of the genome having the function or terminal at the first position. This operator randomly chooses the chromosome or gene to be modified and the start and end of the IS element and is transposed to the start of the gene just after the root.

*Root insertion sequence (RIS) transposition.* It is a short fragment of the genome like the IS element with the only difference being that here the starting point is always a function. It randomly selects the chromosome, the gene to be modified and the start and end point of the RIS element and transpose it to the start point of gene.

*Gene transposition.* In gene transposition, an entire gene works as a transposon and transposes itself to the beginning of the chromosome. In contrast to the other forms of transposition, in gene transposition, the transposon (the gene) is deleted at the place of origin.

*Single or double crossover/recombination.* In single crossover, the parent chromosomes are paired and same point is selected. The portion of the gene downstream of the crossover point is then exchanged between the two chromosomes. In double crossover two parent chromosomes are paired and two points are randomly chosen as crossover points. The material between the crossover points is then exchanged between the parent chromosomes, forming two new offspring chromosomes ([Güven & Ayttek 2010](#)).



*Gene crossover.* In gene crossover, entire genes are exchanged between two parent chromosomes, forming two offspring chromosomes containing genes from both parents. The exchanged genes are randomly chosen and occupy exactly the same position in the parent chromosomes.

Since a random numerical constant is a crucial part of any mathematical model it therefore must be taken into account in deriving an empirical expression for the response function being modeled. GEP has the ability to handle random numerical constants efficiently, given a user-defined range of minimum and maximum values.

Recent application of GEP in different fields includes Ab Ghani & Azamathulla (2011) for sediment transport in the sewer pipe system, Fernando *et al.* (2009) for rainfall-runoff model development, Xie *et al.* (2004) for constructing sentence ranking function, Güven & Ayttek (2010) for the stage discharge relationship, Eldrandaly & Negm (2008) for hydraulic data prediction, Bărbulescu & Băutu (2009) for time series modeling, Nagy *et al.* (2002) for hypertension therapy, Gempeler (2006) for Image compression and Dehuri & Cho (2008) for multi-objective classification rule mining, etc.

## GEP MODELING FOR BRIDGE PIER SCOUR DEPTH USING LABORATORY MODEL DATA

Initially the available data is divided into training and testing datasets. The training set consists of 398 data points and will be used for the development of GEP model, while the testing set consisting of 131 data points and will be used for the model validation. After data division, different parameters for the model were decided which are demonstrated in the following six-step procedure:

1. Like most other evolutionary algorithms, GEP starts with an initial population of individuals. The population of individuals consists of chromosomes of fixed length. The chromosome may be unigenic (single gene) or multigenic. In the current study, multigenic chromosomes (consisting of three genes) were used. Any number of population sizes can be used in the initial population but population sizes in the range of 30–100 chromosomes have given good results in the past (Ferreira 2001b). After several trials, a population size of 30 chromosomes was

selected as the optimal size and was subsequently used in all GEP-based models.

2. After initializing the population, the individuals are evaluated and their fitness function was computed using the mean square error (MSE) as the fitness function:

$$f_i = 1,000 * \frac{1}{1 + E_i} \quad (9)$$

for  $E_i = P_{ij} - O_j$ , where  $P_{(i,j)}$  is the value predicted by the individual chromosome  $i$  for fitness case  $j$  and  $O_j$  is the observed value for fitness case  $j$ . For  $P_{ij} = O_{ij}$  means that  $E_{ij} = 0$  representing a perfect solution with no error.

3. After selecting the fitness function, the next step is to decide the set of terminals and set of functions for the chromosome genes. Here the four basic arithmetic operators and powers were used as functions  $F = \{+, -, *, /, \text{power}\}$ , while the set of terminals  $T = \{F_r, d_{50}/y, b/y, ?\}$  was used, where the terminal ‘?’ represents the random numerical constants.
4. The next step is to decide about the number of genes and the length of head and tail for each gene in a chromosome. According to Ferreira (2001b), increasing the number of genes from one to three will considerably increase the success rate; therefore after some trials three genes per chromosome were used. Head length was taken equal to 10, i.e.  $h = 10$ , and since we have the maximum number of arguments per function is equal to two giving  $n_{\max} = 2$  so the tail length will be calculated by the following relation:  $10 \times (2 - 1) + 1$ , giving a tail length  $t = 11$ . To account for the random numerical constants an additional domain  $D_c$  with length equal to the tail of gene was introduced. Five floating-type random numerical constants will be selected in the range  $\{-10, 10\}$ . So the lengths of the gene is equal to  $10 + 11 + 11 = 32$ , since there are three genes per chromosome so the length of the chromosome is equal to 96.
5. After finalizing the chromosome architecture, genetic operators and their rate were decided. All genetic operators, like mutation, inversion, transposition (IS, RIS and gene-transposition), recombination or crossover (one-point, two-point, and gene-recombination), and  $D_c$  specific genetic operators were used. Two one-point

mutations with a mutation rate of 0.044 were used. The rate of the remaining genetic operators is given in Table 2 below.

- The last step is to select the linking function. Since we have three genes these result in three different sub-ETs. To get the final solution these sub-ETs must be linked through some linking function. In this study the addition operator (+) was used as the linking function.

After all the parameters are defined, the model is simulated. In this study, GeneXproTools 4.0 (Ferreira 2006), a powerful soft computing software package, is used to develop GEP-based models for bridge pier scour depth prediction. This program provides a compact and explicit mathematical expression for the bridge scour model. The terminating criterion was the maximum fitness function

**Table 2** | Parameters of gene expression programming for pier scour depth problem

Parameters	Values
Population size	30
Number of generations	200,000
Function set	+, -, *, /, power
Terminal set	$d_{50}/y$ , $b/y$ , $F_r$ , ?
Random constant array length	05
Random constant type	Floating point
Random constant range	[-10, 10]
Head length	10
Gene length	32
Number of genes	03
Chromosome length	96
Linking function	+
Mutation rate	0.044
Inversion rate	0.1
IS transposition rate	0.1
RIS transposition rate	0.1
Gene transposition rate	0.1
One-point recombination rate	0.1
Two-point recombination rate	0.3
Gene recombination rate	0.3
$D_c$ -specific mutation rate	0.044
$D_c$ -specific inversion rate	0.1
$D_c$ -specific IS transposition rate	0.1
Random constant mutation rate	0.01

which in turn is a function of the mean square error. The program was run for a number of generations and was stopped when there was no improvement in the fitness function value and coefficient of determination. After some trials it was found that after 200,000 generations there was no appreciable change. A sample of model parameters and settings for one representative GEP model are given in Table 2.

The best generation has a fitness 898.3 for  $d_s/y$ . The corresponding explicit equation obtained from the GEP model for  $d_s/y$  is given in Equation (10) and the corresponding expression trees are shown in Figure 10:

$$\frac{d_s}{y} = ET_1 + ET_2 + ET_3 \quad (10)$$

where

$$ET_1 = \left[ \frac{b}{y} + \frac{d_{50}}{y} \right] - \left[ \left( \left( -9.96 - \frac{b}{y} \right) - F_r^{-3.76} \right) * \left( \frac{F_r * (d_{50}/y)}{-5.96} \right) \right]$$

$$ET_2 = \left[ \frac{(b/y)}{-9.58} * \left[ F_r * \left\{ (2 * F_r + (b/y)) - \left( (b/y) * \frac{d_{50}}{y} \right) \right\} \right] \right]$$

$$ET_3 = \left[ 0.04 * F_r * (F_r^{-0.79} + 9.03) * \left\{ (F_r^{(b/y)})^{((b/y)+(d_{50}/y))} \right\}^{(b/y)} \right]$$

## RESULTS AND DISCUSSION OF GEP MODELING

Laboratory model data from previous literature and research work done by other researchers is used in this study. The performance of the AI-based technique, namely GEP, is evaluated by comparing its performance to other models including regression and ANN models. The regression-based empirical equations used for comparison include those derived by Jain & Fischer (1979), revised Shen II equation (2010), revised Hancu equation (2010) and the newly developed MLR-based equation, given as Equation (3), (4), (5) and (7), respectively. The values of three statistical measures, i.e.  $R^2$ , RMSE and average absolute error (AAE), were calculated for all the above-mentioned models. The performance of all models developed in terms of statistical measures is given in Table 3. The scattered

**Table 3** | Summary of model results for all modeling techniques

Scour model	Training			Testing		
	AAE	RMSE	$R^2$	AAE	RMSE	$R^2$
Jain & Fischer (1979)	–	–	–	1.3210	2.8999	0.20
Revised Shen II	–	–	–	0.7594	1.7052	0.13
Revised Hancu	–	–	–	0.7471	1.0646	0.14
Newly developed MLR-based model	0.2905	0.4386	0.63	0.4544	0.9901	0.38
ANN	0.2260	0.3508	0.81	0.2317	0.3526	0.74
GEP	0.3273	0.4130	0.79	0.2407	0.3674	0.73

plots for all the models developed are also drawn and are shown in Figures 2–10.

Table 3 reveals that, although the Jain & Fischer equation gives maximum values for RMSE and AAE, it gives a good  $R^2$  value when compared to the other two regression-based models. The newly developed regression-based model performs better than all the three previously developed regression-based equations. The revised Shen II equations give the worst results followed by the revised Hancu equation. The relatively inferior performance of the regression-based models further strengthens the notion that such models are not always suited for effectively predicting bridge pier scour depth, given its prediction capability. Also, the three existing regression-based

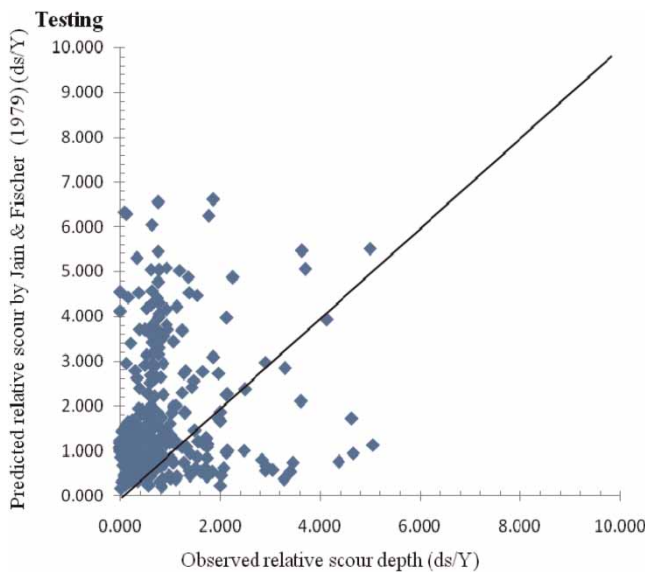
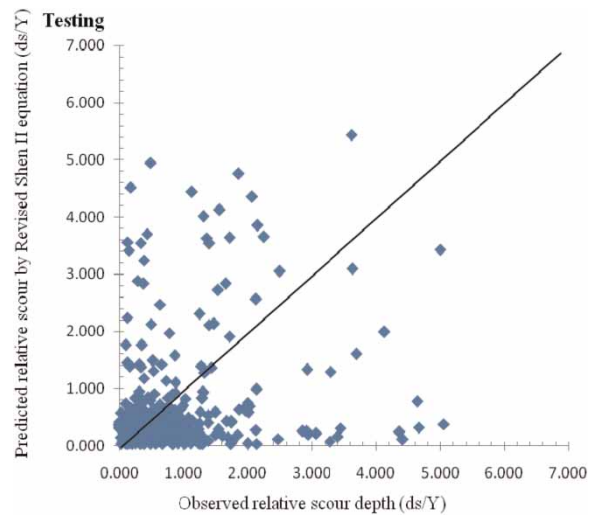
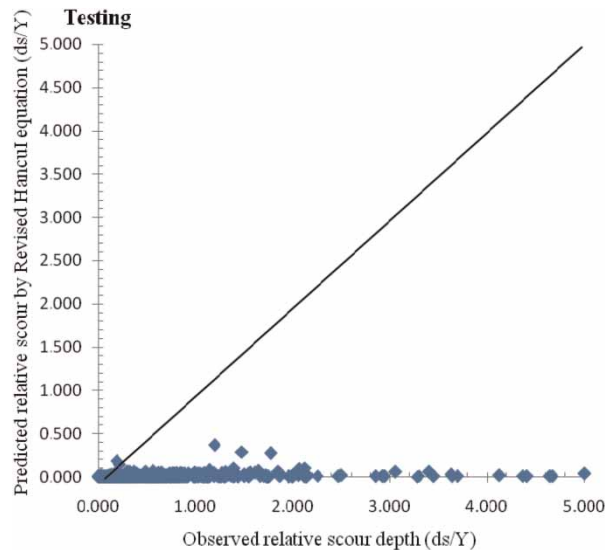
**Figure 2** | Scattered plot of observed and predicted ( $d_s/y$ ) using Jain & Fischer (1979).**Figure 3** | Scattered plot of observed and predicted ( $d_s/y$ ) using the revised Shen II equation.**Figure 4** | Scattered plot of observed and predicted ( $d_s/y$ ) using the revised Hancu equation.

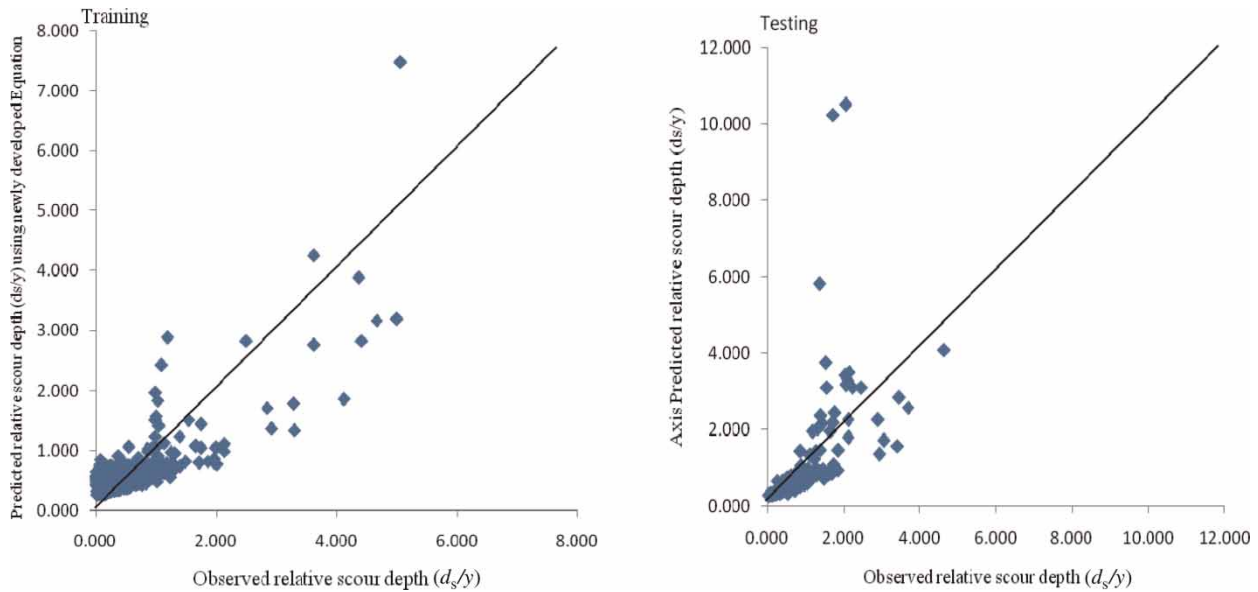

**Figure 5** | Scattered plot of observed and predicted ( $d_s/y$ ) using newly developed MLR-based equation.

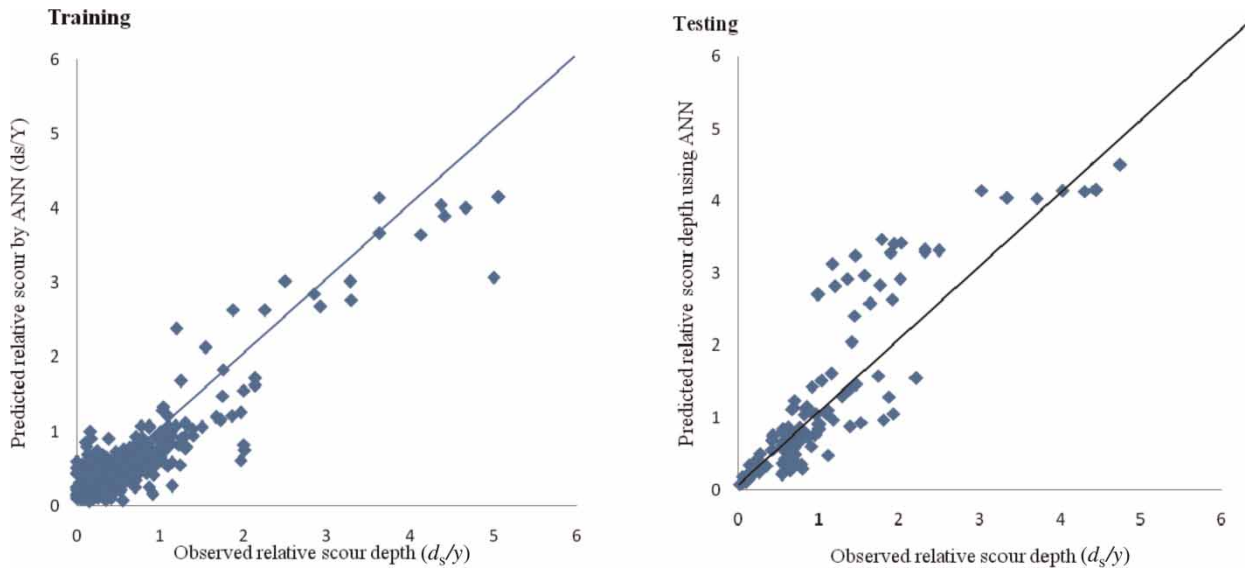

**Figure 6** | Scattered plot of observed and predicted ( $d_s/y$ ) using ANN.

equations used in this study (Equations (3)–(5)) do not contain all of the influential and important parameters needed to accurately predict bridge pier scour such as depth of water, sediment size and standard deviation of bed material. On comparing the scattered graph of Figures 2–5 it was concluded that the newly developed MLR-based equations performed better than the three previously developed

regression-based equations but much inferior to the AI-based models including ANN and GEP.

The values of the statistical measures in Table 3 shows that ANN performs better than GEP because it gives smaller values for RMSE and AAE and a slightly greater value of  $R^2$  as compared to GEP. The scatter plot of training as well as testing using ANN is shown in Figure 6 while that using

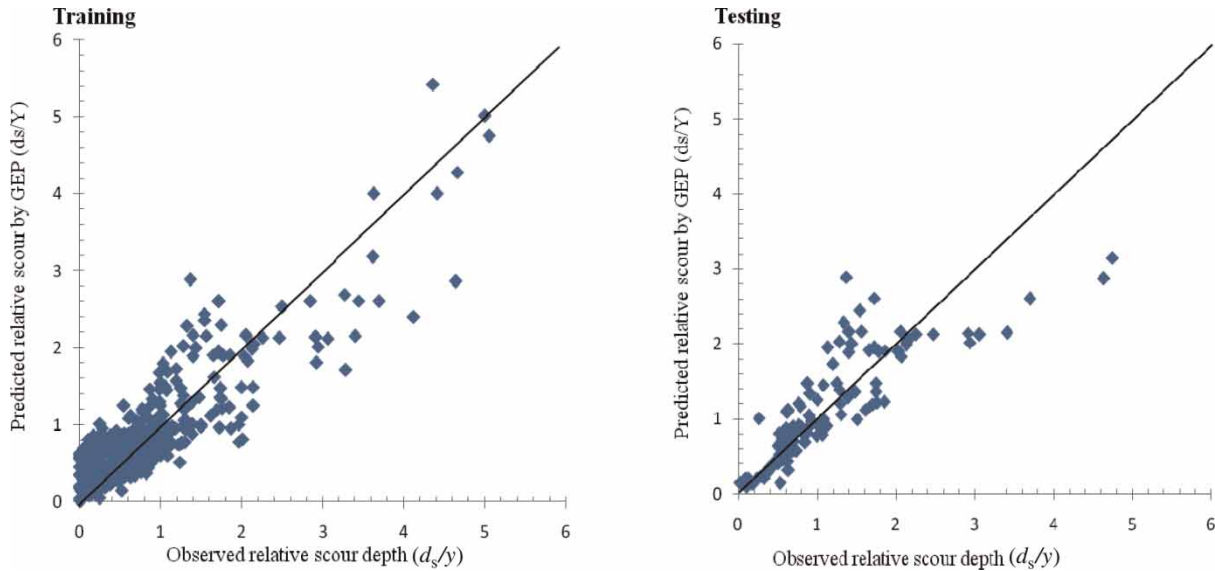

Figure 7 | Scattered plot of observed and predicted ( $d_s/y$ ) using GEP.

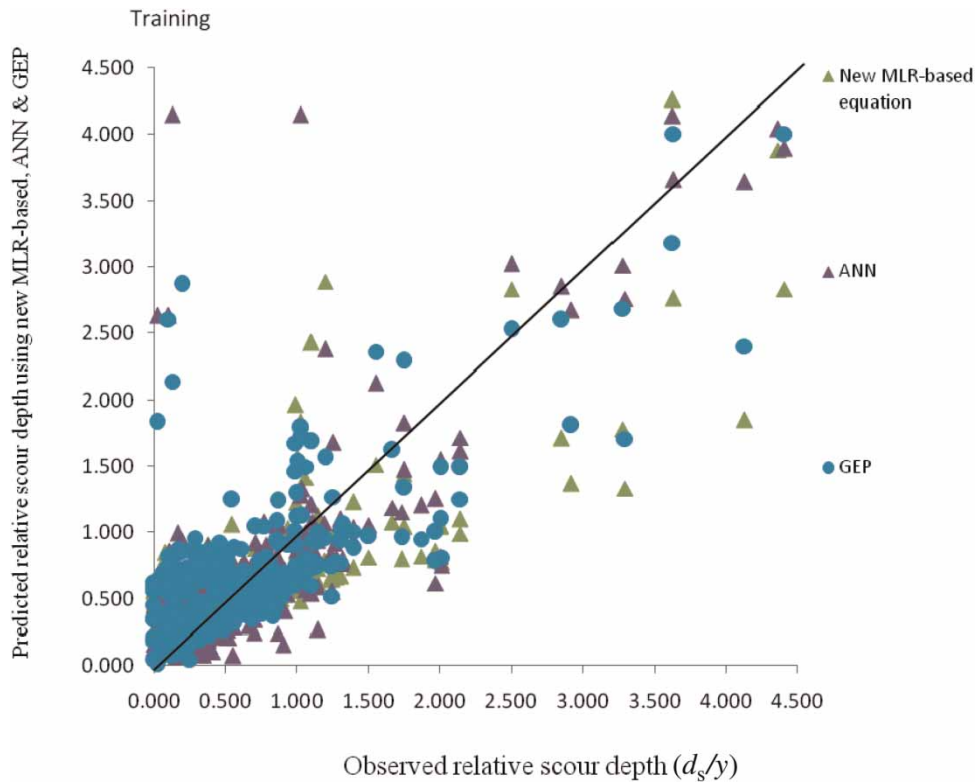
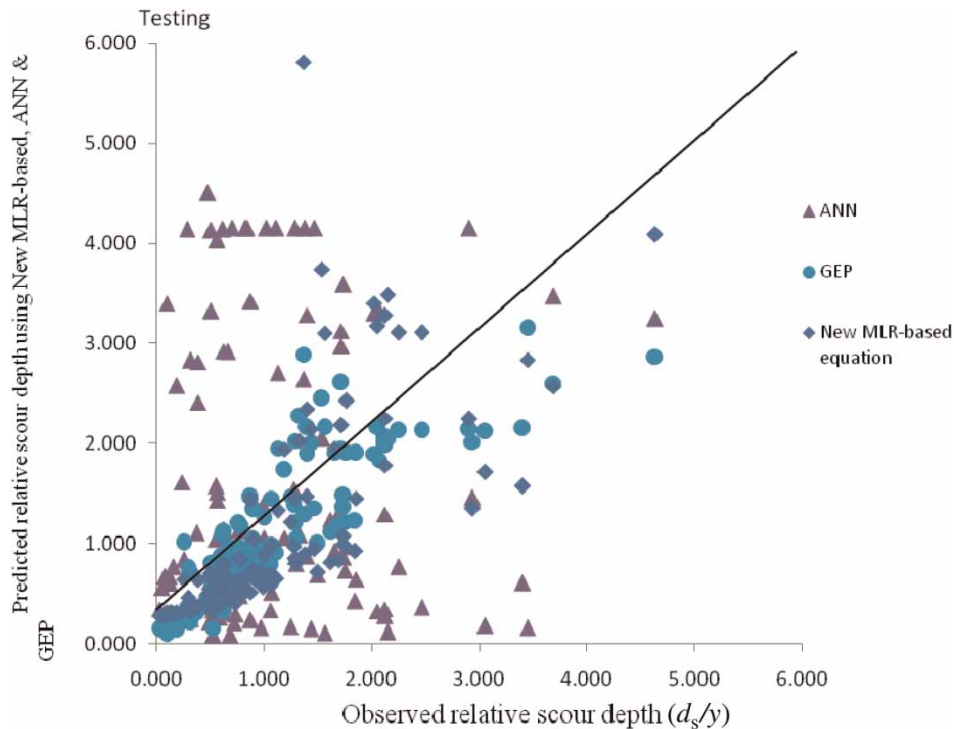

Figure 8 | Comparison between MLR, ANN and GEP models (training data).

GEP is in Figure 7. These figures also show that ANN performs slightly better than GEP. The comparison of the MLR, ANN, and GEP models in a single plot is shown in

Figures 8 and 9. GEP has the unique property of providing an easy-to-use explicit expression as shown by Equation (10) which gives it an edge over ANN.



**Figure 9** | Comparison between MLR, ANN and GEP models (testing data).

In summary, the regression-based equations show very low performances and are not suggested to be effective for design purposes. Although ANN performs slightly better than GEP with respect to the statistical measures and scatter plots it does not give any explicit mathematical expression. Lastly, GEP has the ability to provide an explicit and compact empirical expression that can be helpful for the designers in future.

## CONCLUSIONS

Bridge pier scour is a complex phenomenon and there is a need to accurately predict the scour depth. The use of new AI-based models for bridge scour modeling adds to the limited applications that exist in this area. Bridge scour modeling is challenging owing to the significant variability in the various input decision variables. This is encountered in both data-driven and process-based (deductive) modeling approaches. While deductive models may be preferred owing to their ability to better reflect the true dynamics of the process or processes modeled, there are scenarios

where this is not possible, such as computational expense constraints, lack of extensive knowledge of the process being modeled, and budgetary or other non-monetary constraints that prevent the development of deductive models. In such scenarios, data-driven models can be effectively used to model bridge pier scour based on available field or laboratory data.

This paper investigated the use of MLR and AI-based data-driven models for predicting the relative bridge pier scour depth utilizing laboratory data collected previously by various research efforts. Consequently, this paper explored the utility of a range of data-driven modeling techniques, from simple (MLR) to complex (AI-based) in nature. In particular, a new AI-based soft computing technique, GEP, was applied for the prediction of the bridge pier scour depth using laboratory model data and then its results were compared with another AI-based technique, namely ANN, as well as conventional regression-based models. The performance of the optimal empirical model developed using GEP was found to be significantly better than all regression-based models but slightly inferior to ANN in terms of the statistical measures. Table 3 shows that the

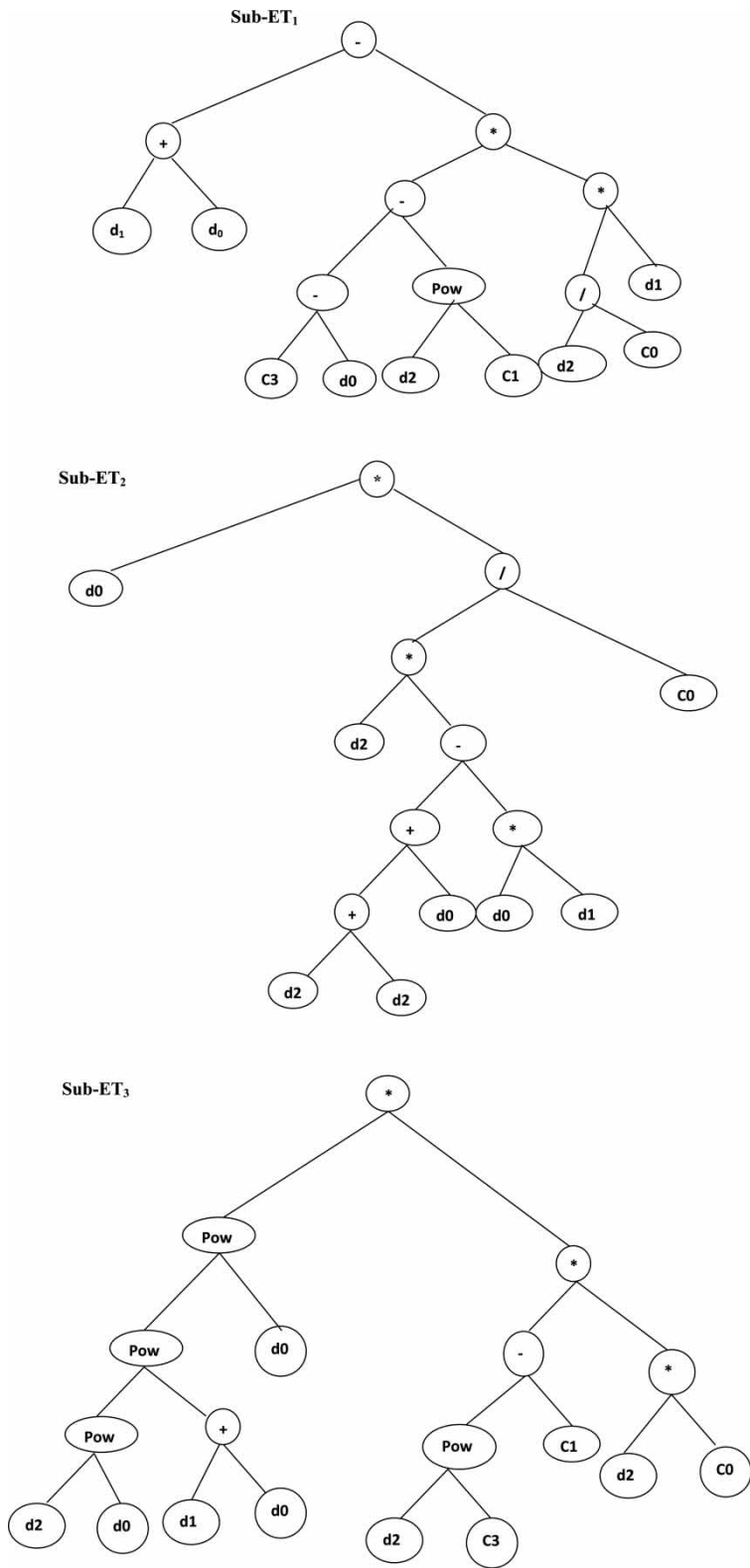

Figure 10 | Expression tree (ET) for the GEP formulation.

statistical measures  $R^2$ , AEE and RMSE for GEP are superior to the regression models but slightly inferior to the ANN model. Although ANN performs slightly better than GEP but it did not give any compact mathematical expression for use by designers while the GEP has the advantage that it results in an explicit and compact equation (Equation (10)), which can be used by engineers in bridge design.

The study also validates the promise of GEP as an effective modeling tool for applications in hydraulic modeling. GEP comes with the added advantage of providing a simple and easy-to-use empirical expression for the response function modeled. In contrast, ANN-based models require considerable data for training and are not favorable for applications where the objective is to obtain a simple, easy to use and functionally compact approximation. As the number of hidden layers and number of neurons in each hidden layer increases, the functional form extracted from these so-called black-box models can turn out to be a long expression (a linear and nonlinear combination of sigmoidal functions) with numerous terms.

## REFERENCES

- Ab Ghani, A. & Azamathulla, H. Md. 2011 [Gene-expression programming for sediment transport in sewer pipe systems](#). *J. Pipeline Syst. Engng. Pract.* **2** (3).
- Ab Ghani, A., Azamathulla, H. Md., Yahaya, A. S. & Zakaria, N. A. 2010 Revised equations for bridge pier scour prediction. *Hydro 2010 India*.
- ASCE 2000a [Task committee on application of artificial neural networks in hydrology. I: preliminary concepts](#). *J. Hydrol. Engng.* **5** (2), 115–123.
- ASCE 2000b [Task committee on application of artificial neural networks in hydrology. II: hydrologic applications](#). *J. Hydrol. Engng.* **5** (2), 124–137.
- Azamathulla, H. Md., Deo, M. C. & Deolalikar, P. B. 2005 [Neural networks for estimation of scour downstream of ski-jump bucket](#). *J. Hydraul. Eng.* **131** (10), 898.
- Azamathulla, H. Md., Chang, C. K., Ab Ghani, A., Zakaria, N. A. & Abu Hassan, Z. 2008 An ANFIS-based approach for predicting the bed load for moderately sized rivers. *J. Hydro-environ. Res.* **2009**, 35–44.
- Azamathulla, H. Md., Ab Ghani, A., Zakaria, N. A. & Guven, A. 2010 [Genetic programming to predict bridge pier scour](#). *J. Hydraul. Engng.* **136** (3), 165–169.
- Babovic, V. & Bojkov, V. H. 2001 [Runoff Modeling with Genetic Programming and Artificial Neural Networks](#). D2K Technical Rep. No. D2K TR 0401-1. DHI, Copenhagen.
- Bărbulescu, A. & Băutu, E. 2009 Time series modeling using an adaptive gene expression programming algorithm. *Int. J. Math. Models Meth. Appl. Sci.* **3** (2).
- Bateni, S. M., Borghei, S. M. & Jeng, D.-S. 2007 [Neural network and neuro-fuzzy assessments for scour depth around bridge piers](#). *Engng. Appl. Artif. Intell.* **20**, 401–414.
- Breusers, H. N. C., Nicollet, G. & Shen, H. W. 1977 [Local scour around cylindrical pier](#). *J. Hydraul. Res.* **15** (3), 211–252.
- Chabert, J. & Engeldinger, P. 1956 [Etude des affouillements autour des piles des ponts](#). Laboratoire d'Hydraulique, Chatou, France (in French).
- Chee, R. K. W. 1982 [Live-bed Scour at Bridge Piers](#). Rep. No. 290, School of Engineering, University of Auckland, Auckland, New Zealand.
- Chiew, Y. M. 1984 [Local Scour at Bridge Piers](#). Rep. No. 355, School of Engineering, University of Auckland, Auckland, New Zealand.
- Coleman, S. E. & Melville, B. W. 2001 [Case study: New Zealand bridge scour experiences](#). *J. Hydraul. Engng.* **127** (7), 535–546.
- Coppola Jr., E., Szidarovszky, F., Poulton, M. & Charles, E. 2003 [Artificial neural network approach for predicting transient water levels in a multilayered groundwater system under variable state, pumping, and climate conditions](#). *J. Hydraul. Engng.* **8** (6), 348–360.
- Daniel, T. M. 1991 Neural networks—application in hydrology and water resources engineering. In *Proc. Int. Hydro Water Resource Symp.*, Institute of Engineers, Perth, Australia. Institute of Engineers, Perth, pp. 797–802.
- Dehuri, S. & Cho, S. B. 2008 [Multi-objective classification rule mining using gene expression programming](#). In *Proc. 3rd 2008 International Conference on Convergence and Hybrid Information Technology*. IEEE.
- Eldrandaly, K. & Negm, A. A. 2008 Performance evaluation of gene expression programming for hydraulic data mining. *Int. Arab J. Inf. Technol.* **5** (2), 126–131.
- Ettema, R. 1980 [Scour at Bridge Piers](#). Rep. No. 216. University of Auckland, Auckland, New Zealand.
- Ettema, R., Melville, B. W. & Barkdoll, B. 1998 [Scale effect of pier-scour experiments](#). *J. Hydraul. Engng.* **124** (6), 639–642.
- Fernando, D. A. K., Shamseldin, A. Y. & Abrahart, R. J. 2009 Using gene expression programming to develop a combined runoff estimate model from conventional rainfall–runoff model outputs. In *Proc. 18th World IMACS/MODSIM Congress*, Cairns, Australia, 13–17 July.
- Ferreira, C. 2009a Gene expression programming in problem solving. In *Proc. 6th Online World Conference on Soft Computing in Industrial Applications Invited tutorial*. Springer-Verlag, Berlin.
- Ferreira, C. 2009b Gene expression programming: a new adaptive algorithm for solving problems. *Complex Syst.* **13** (2), 87–129.



- Ferreira, C. 2006 *Gene Expression Programming, Studies in Computational Intelligence*. Springer-Verlag, Berlin.
- Florida Department of Transportation (FDOT) 2005 *Bridge Scour Manual*. FDOT, Tallahassee, FL.
- Gempeler, M. 2006 *Image Compression Using Gene Expression Programming*. Technical report, NSF Research Experiences for Undergraduates, Computer Vision and Image Processing, Department of Computer Science, Utah State University.
- Govindaraju, R. S. & Rao, A. R. 2000 *Artificial Neural Networks in Hydrology*. Kluwer, Dordrecht.
- Graf, W. H. 1995 *Load Scour Around Piers*. Annual Rep., Laboratoire de Recherches Hydrauliques, Ecole Polytechnique Federale de Lausanne, Lausanne, Switzerland, pp. B.33.1–B.33.8.
- Grubert, J. P. 1995 *Application of neural networks in stratified flow stability analysis*. *J. Hydraul. Engng.* **121** (7), 523–532.
- Güven, A. & Aytek, A. 2010 *A new approach for stage-discharge relationship: gene-expression programming*. *J. Hydrol. Engng.* **14** (8), 812–820.
- Hancu, S. 1971 *Sur le calcul des affouillements locaux dans la zone des piles des ponts*. In *Proc. 14th IAHR Congress*, Paris, France. Vol 3, IAHR, Madrid, Spain, pp. 299–313.
- Haykin, S. 1994 *Neural Networks: A Comprehensive Foundation*. Macmillan, New York.
- Jain, A. & Prasad Indurthy, S. K. V. 2003 *Comparative analysis of event-based rainfall runoff modeling techniques—deterministic, statistical, and artificial neural networks*. *J. Hydrol. Engng.* **8** (2), 93–98.
- Jain, S. C. & Fischer, E. E. 1979 *Scour Around Circular Piers at High Froude Numbers*. Rep. No. FHWA-RD-79-104, US Department of Transportation, Federal Highway Administration, Washington, DC.
- Jeng, D. S., Bateni, S. M. & Lockett, E. 2006 *Neural Network Assessment for Scour Depth Around Bridge Piers*. Research rep. no. R855.
- Kambekar, A. R. & Deo, M. C. 2003 *Estimation of group pile scour using neural networks*. *J. Appl. Ocean Res.* **25**, 225–234.
- Karunanithi, N., Grenney, W. J., Whitly, D. & Bovee, K. 1994 *Neural networks for river flow production*. *J. Comput. Civil Engng.* **8** (2), 201–220.
- Kothiyari, U. C., Grade, R. J. & Ranga Raju, K. G. 1992 *Temporal variation of scour around circular bridge piers*. *J. Hydraul. Engng.* **118** (8), 1091–1106.
- Koza, J. R. 1999 *Genetic Programming: On the Programming of Computers by Means of Natural Selection*. MIT Press, Cambridge, MA.
- Lauchlan, S. C. & Melville, B. W. 2001 *Riprap protection at bridge piers*. *Hydraulic Engineering* **127** (5), May. ASCE.
- Laursen, E. M. & Toch, A. 1956 *Scour Around Bridge Piers and Abutments*. Bulletin No. 4, Iowa Highway Research Board, Ames, IA.
- Lee, T. L., Jeng, D. S., Zhang, G. H. & Hong, J. H. 2007 *Neural network modeling for estimation of scour depth around bridge piers*. *J. Hydrodyn.* **19** (3), 378–386.
- Lingireddy, S., Brion, G. M., Chandramouli, V. & Neelakantan, T. R. 2003 *Neural Network Modeling Software for Water and Environmental Engineering*. Civil Engineering Department, University of Kentucky, Lexington, KY.
- Maier, H. R. & Dandy, G. C. 1998 *The effect of internal parameters and geometry on the performance of back-propagation neural networks: an empirical study*. *Environ. Modell. Software* **13** (2), 193–209.
- Melville, B. W. 1997 *Pier and abutment scour: integrated approach*. *J. Hydraul. Engng.* **123** (2), 125–136.
- Melville, B. V. & Sutherland, A. J. 1988 *Design method for local scour at bridge piers*. *J. Hydraul. Engng.* **114**, 1210–1226.
- Melville, B. W. & Chiew, Y. M. 1999 *Time scale for local scour depth at bridge piers*. *J. Hydraul. Engng.* **125** (1), 59–65.
- Mia, M. F. & Nago, H. 2003 *Design methods of time-dependent local scour at circular bridge piers*. *J. Hydraul. Engng.* **129** (6), 420–427.
- Minns, A. W. 1998 *Artificial Neural Networks as Sub Symbolic Process Descriptors*. A.A. Balkema, Rotterdam.
- Mohammad, T. A., Noor, M. M., Ghazali, A. H. & Huat, B. K. 2005 *Validation of some bridge pier scour formulae using field and laboratory data*. *Am. J. Environ. Sci.* **1** (2), 119–125.
- Molinas, A. 2003 *Bridge Scour in Non uniform Sediment Mixtures and In Cohesive Materials: Synthesis Report*. FHWA-RD-03-083. US Department of Transportation, Federal Highway Administration, Washington, DC.
- Muzzammil, M. & Ayyub, M. 2009 *ANFIS-based approach for scour depth prediction at piers in non-uniform sediments*. *J. Hydroinf.* **12** (3), 303–317.
- Muzzammil, M. & Gangadharaiah, T. 2003 *The mean characteristics of horseshoe vortex at a cylindrical pier*. *J. Hydraul. Res.* **41** (3), 285–297.
- Nagy, H., Watanabe, K. & Hirano, M. 2002 *Prediction of sediment load concentration in river using artificial neural network model*. *J. Hydraul. Engng.* **128** (6), 588–595.
- Oliveto, G. & Hager, W. H. 2002 *Temporal evolution of clear-water pier and abutment scour*. *J. Hydraul. Engng.* **128** (9), 811–820.
- Richardson, E. V. & Davis, S. R. 1995 *Evaluating Scour at Bridges*. Hydraulic Engineering Circular 18 Publ. FHWA-IP-90-017. US Department of Transportation, Federal Highway Administration, Washington, DC. Report FHWA NHI 01-001.
- Rumelhart, D. E. & McClelland, J. L. 1986 *Parallel Distributed Processing*. MIT Press, Cambridge, MA.
- Shen, H. W. 1971 *Scour near piers*. In: *River Mechanics*. Vol II, ch 23, Fort Collins, CO.
- Sheppard, D. M., Odeh, M. & Glasser, T. 2004 *Large scale clearwater local pier scour experiments*. *J. Hydraul. Engng.* **130** (10), 957–963.
- Sudheer, K. P. & Jain, S. K. 2003 *Radial basis function neural network for modeling rating curves*. *J. Hydrol. Engng.* **8** (3), 161–164.
- Ting, C. K., Briaud, J. L., Chen, H. C., Gudavalli, R., Perugu, S. & Wei, G. 2001 *Flume tests for scour in clay at circular piers*. *J. Hydraul. Eng.* **127**, 969.

- Tufail, M., Ormsbee, L. E. & Teegavarapu, R. 2008 [Artificial intelligence-based inductive models for prediction and classification of fecal coliform in surface waters](#). *J. Environ. Engng.* **134** (9), 789.
- US Department of Transportation 2001 *Evaluating Scour at Bridges*. Hydraulic Engineering Circular No. 18, Pub. No. FHWA NHI 01-001. US Department of Transportation, Federal Highway Administration, Washington, DC.
- Xie, Z., Li, X., Eugenio, B. D., Xiao, W., Tirpak, M. T. & Nelson, P. C. 2004 Using gene expression programming to construct sentence ranking functions for text summarization. In *Proc 20th International Conference on Computational Linguistics*. Association for Computational Linguistics Stroudsburg, PA, pp. 1381–1384.
- Yanmaz, A. M. 2003 Reliability simulation of scouring downstream of outlet facilities. *Turkish J. Engng. Environ. Sci.* **27**, 65–71.
- Yanmaz, A. M. & Altinbilek, H. D. 1991 [Study of time-dependent local scour bridge piers](#). *J. Hydraul. Engng.* **117** (10), 1247–1268.
- Zurada, J. M. 1992 *Introduction to Artificial Neural Systems*. PWS Publishing, Boston.

First received 17 January 2011; accepted in revised form 16 June 2011. Available online 8 November 2011