

# Differential evolution algorithm for optimal design of water distribution networks

C. R. Suribabu

## ABSTRACT

Water distribution networks are considered as the most important entity in the urban infrastructure system and need huge investment for construction. The inherent problem associated with cost optimisation in the design of water distribution networks is due to the nonlinear relationship between flow and head loss and availability of the discrete nature of pipe sizes. In the last few decades, many researchers focused on several stochastic methods of optimisation algorithms. The present paper is focused on the Differential Evolution algorithm (henceforth referred to as DE) and utilises a similar concept as the genetic algorithm to achieve a goal of optimisation of the specified objective function. A simulation–optimisation model is developed in which the optimization is done by DE. Four well-known benchmark networks were taken for application of the DE algorithm to optimise pipe size and rehabilitation of the water distribution network. The findings of the present study reveal that DE is a good alternative to the genetic algorithm and other heuristic approaches for optimal sizing of water distribution pipes.

**Key words** | differential evolution, rehabilitation, water distribution networks

**C. R. Suribabu**  
School of Civil Engineering,  
SASTRA University,  
Thanjavur 613402,  
India  
E-mail: [suribabu@civil.sastra.edu](mailto:suribabu@civil.sastra.edu)

## NOTATION

The following symbols are used in this paper.

|                  |   |                    |   |
|------------------|---|--------------------|---|
| $X_{i,j}^{(G)}$  | $j$ th component (diameter of $j$ th link) of $i$ th candidate solution | $H_{\text{allow}}$ | allowable pressure head   |
| $X_i^{(G)}$      | $i$ th candidate solution or individual in the $G$ th generation        | $hf_i$             | head loss due to friction in pipe $i$                               |
| $[D]$            | set of available pipe sizes   | $H_{\text{min}}$   | minimum required pressure head                                      |
| $f(x_i^{(G)})$   | cost of $i$ th individual in $G$ th generation                          | $H_n$              | pressure head at node $n$   |
| $x_j^{(L)}$      | lower limit of variable $j$   | in, $n$            | set of pipes entering to the node $n$                               |
| $x_j^{(U)}$      | upper limit of variable $j$   | $L_i$              | length of the pipe $i$  |
| $A, B$ and $C$   | randomly selected solution vectors                                      | $NL$               | loop set  |
| $C_{\text{HW}}$  | Hazen–Williams coefficient  | $NN$               | node set  |
| $C_r$            | user-defined crossover constant   | $NP$               | number of pipes   |
| $D_i$            | diameter of the pipe $i$  | $n_{\text{pop}}$   | population size   |
| $F$              | user-defined weighting factor (mutation constant)                       | $n_{\text{var}}$   | number of variables   |
| $G_{\text{max}}$ | user-defined maximum number of generations                              | out, $n$           | set of pipes emerging from node $n$                                 |
| $H_{\text{act}}$ | actual pressure head  | $P^{(G)}$          | population in $G$ th generation                                     |
|                  |   | $Q_i$              | flow in pipe $i$  |
|                  |   | rand $_{ij}$       | uniformly distributed random value within the range of (0.0 to 1.0) |
|                  |   | WDV                | weighted differential vector  |
|                  |   | $\alpha$           | conversion factor   |
|                  |   | $\Delta H$         | difference in nodal heads between ends                              |

doi: 10.2166/hydro.2010.014

## INTRODUCTION

The water distribution system is one of the major requirements in urban and regional economic development. For any agency dealing with the design of the water distribution network, an economic design will be an objective. The funds needed for the construction, maintenance and operation of these systems require the achievement of a good compromise between technical and economic aspects. Several methods are available to design a water distribution network in which rule of thumb and trial and error are the most popular methods. With the development of high speed digital computers and improved optimisation techniques, the design of water distribution networks was attempted since the 1970s. The complexity of the problem is due to the nonlinear relationship between flow and head loss, the presence of discrete decision variables such as pipe diameter, cost functions for the materials, labour, geographical layout, multiple demand loading patterns, uncertainty in demands, and location of tanks, pumping stations, booster pumps, valves, etc. Numerous works were reported in the literature for optimal design and some of them considered certain reliability aspects too. In optimisation models, continuous diameters (Pitchai 1966; Jacoby 1968; Varma *et al.* 1997) and split pipes (Alperovits & Shamir 1977; Quindry *et al.* 1979; Goulter *et al.* 1986; Fujiwara *et al.* 1987; Kessler & Shamir 1989; Bhawe & Sonak 1992) were more prominently used. Conversion of continuous diameter to the nearest commercial size after optimisation does not guarantee the true optimal solution. Also use of a split pipe length with different diameters for a link is very uncommon in practice. The last two decades witnessed a growing interest in adapting evolution-based algorithms, which overcome such a problem. A straightforward approach to the solution of such a problem would be the enumeration of all possible solutions and choosing the best one. Unfortunately, in most cases, such an approach becomes rapidly infeasible because of the exponential growth of possible solutions with the increase in the number of variables. Moreover the design of a water distribution system is a combinatorial problem, which generally possesses greater numbers of local optima. Hence, deep insight into the problem structure and understanding of specific characteristics of the problem

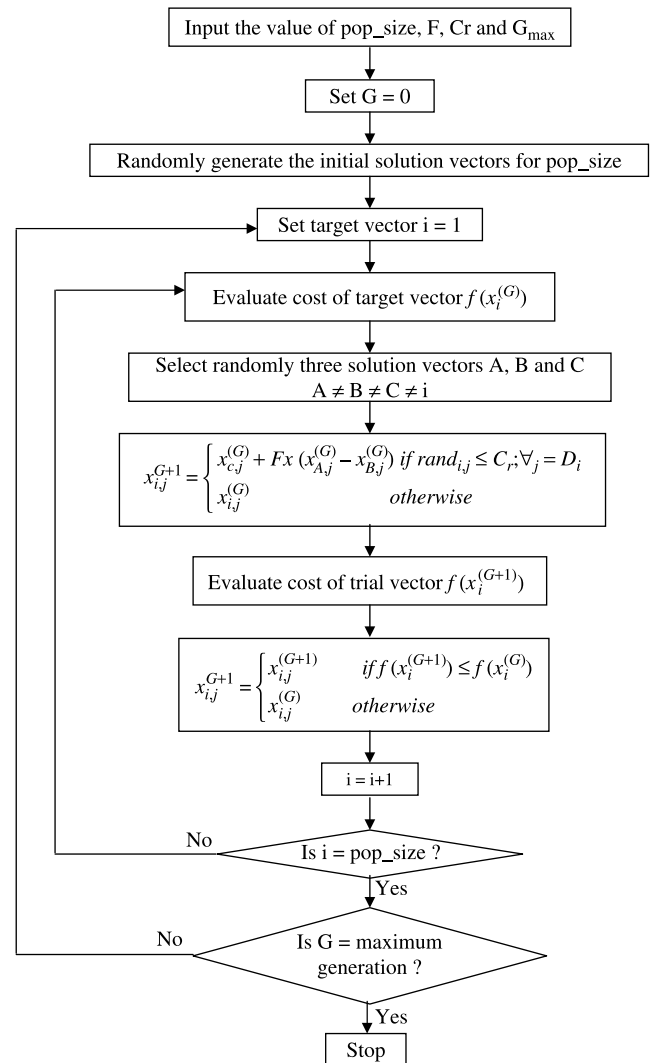

Figure 1 | Steps in differential evolution algorithm.

permits the heuristic and meta-heuristic algorithm to explore the solution in less computational time, but unfortunately resulting in an enormous computational burden due to the relatively large number of hydraulic simulations. Several attempts were made by researchers to reduce the number of hydraulic simulations and for easy handling of discrete variables. Application of the genetic algorithm (Dandy *et al.* 1996; Savic & Walters 1997; Vairavamoorthy & Ali 2000, 2005), the modified genetic algorithm (Montesinos *et al.* 1999; Neelakantan & Suribabu 2005; Kadu *et al.* 2008), the simulated annealing algorithm (Cunha & Sousa 1999), the shuffled leapfrog algorithm

(Eusuff & Lansey 2003), ant colony optimization (Maier *et al.* 2003; Zecchin *et al.* 2007; Ostfeld & Tubaltzev 2008), novel cellular automata (Keedwell & Khu 2006) and the particle swarm algorithm (Suribabu & Neelakantan 2006a,b) for optimal design of water distribution systems are some of them. The present paper is focused on implementation of the DE algorithm for optimal design

and rehabilitation of water distribution networks. Use of addition, subtraction and component swapping are the distinguishing features of DE that successively update the population of solution vectors, until the population hopefully converges to an optimal solution. In the recent past, DEA was used to optimise the water pumping system (Babu & Angira 2003), multi-objective reservoir system

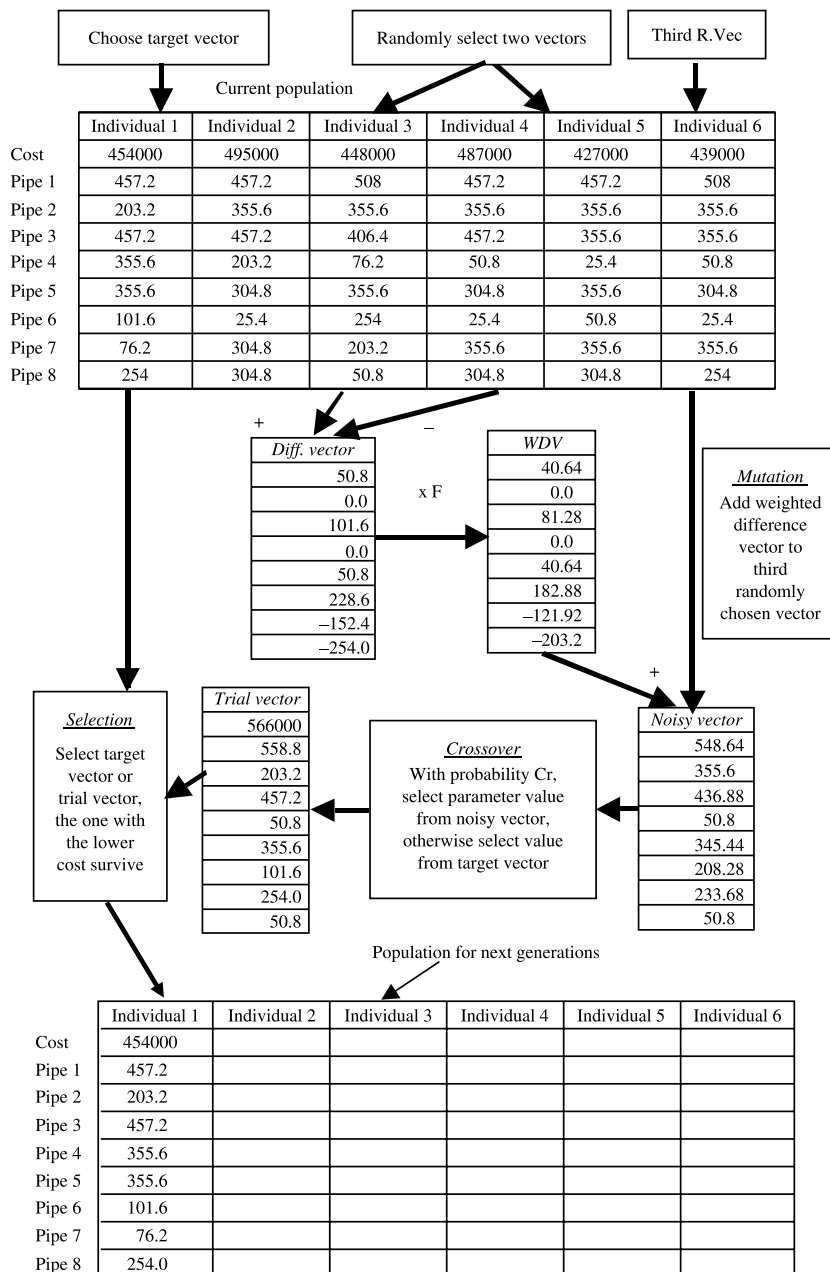

Figure 2 | Computational module for differential evolution algorithm.

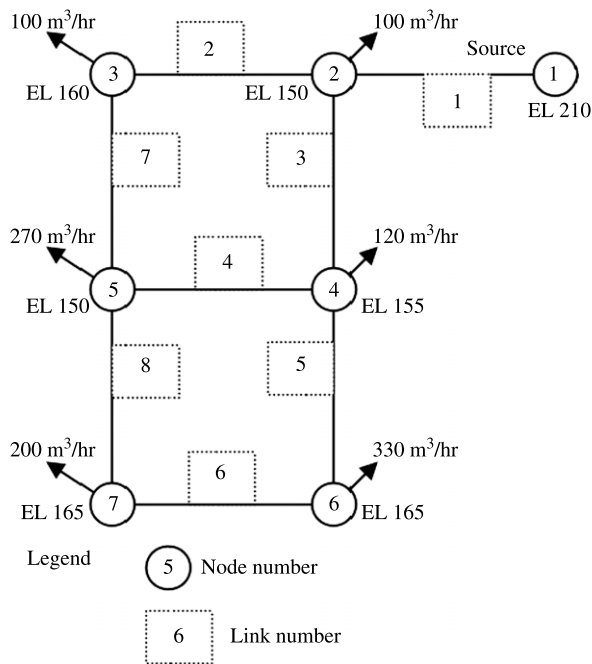

Figure 3 | Layout of example network 1 (two-loop network).

operation (Janga Reddy & Nagesh Kumar 2007) and irrigation system planning (Vasan & Raju 2007).

## OPTIMISATION MODEL

The problem of optimal design of the water distribution network usually has an objective of minimising the total capital cost. For a given layout, details like demand and elevation of the node, tank size and its bottom level are assumed as known variables. The objective is to find a combination of different sizes of pipe that gives the minimum cost subjected to the following constraints.

Continuity of flow in each node must be maintained in the network. The continuity principle states that the quantity of flow into the node must be equal to the quantity of flow leaving that node. The quantity of flow leaving the node includes the external demand and flow passes out through other pipes emerging from the node. Mathematically it is expressed as

$$\sum_{i \in \text{in}, n} Q_i = \sum_{j \in \text{out}, n} Q_j + ND_n \quad \forall n \in NN \quad (1)$$

where  $Q$  = pipe flow;  $ND_n$  = demand at node  $n$ ; in,  $n$  = set of pipes entering to the node  $n$ ; out,  $n$  = set of pipes emerging from node  $n$  and  $NN$  = node set.

The total head loss around the closed path (loop) should be equal to zero or the head loss along a path between the two fixed head nodes should be equal to the difference in elevation:

$$\sum_{i \in \text{loop } p} hf_i = \Delta H, \quad \forall p \in NL \quad (2)$$

where  $hf_i$  = head loss due to friction in pipe  $i$ ;  $NL$  = loop set;  $\Delta H$  = difference between nodal heads at both ends and  $\Delta H = 0$ , if the path is closed.

The Hazen-Williams head loss equation for pipe  $i$  of connecting nodes  $j$  and  $k$  is

$$H_j - H_k = hf_i = \frac{\alpha L_i Q_i |Q_i|^{0.852}}{C_{HW,i}^{1.852} D_i^{4.87}} \quad \forall j \in NP \quad (3)$$

where  $NP$  = number of pipes;  $C_{HW}$  = Hazen-Williams coefficient;  $D_i$  = diameter of the pipe  $i$ ;  $L_i$  = length of the pipe  $i$  and  $\alpha$  = conversion factor which depend on the units used for calculation (in this,  $\alpha = 10.667$ ).

The pressure head in all nodes should be greater than the prescribed minimum pressure head:

$$H_n \geq H_{\min} \quad (4)$$

Table 1 | Pipe cost data for example 1 (two-loop network)

| Diameter (in) | Diameter (mm) | Cost (units) |
|---------------|---------------|--------------|
| 1             | 25.4          | 2            |
| 2             | 50.8          | 5            |
| 3             | 76.2          | 8            |
| 4             | 101.6         | 11           |
| 6             | 152.4         | 16           |
| 8             | 203.2         | 23           |
| 10            | 254.0         | 32           |
| 12            | 304.8         | 50           |
| 14            | 355.6         | 60           |
| 16            | 406.4         | 90           |
| 18            | 457.2         | 130          |
| 20            | 508.0         | 170          |
| 22            | 558.8         | 300          |
| 24            | 609.6         | 550          |

**Table 2** | Results of the trial runs for two-loop network

| Trial run number   | Weighting factor | Crossover probability | Number of times the least cost solution obtained (out of 30 trials) | Average number of function evaluation in getting least cost solution |
|--|------------------|-----------------------|---|--|
| 1  | 0.8              | 0.5                   | 14  | 5,564  |
| 2  | 0.8              | 0.4                   | 20  | 4,350  |
| 3  | 0.7              | 0.5                   | 10  | 4,328  |
| 4  | 0.6              | 0.5                   | 14  | 3,378  |
| 5  | 0.6              | 0.4                   | 15  | 4,005  |
| 6  | 0.7              | 0.4                   | 9   | 5,051  |
| 7  | 0.8              | 0.3                   | 12  | 5,116  |
| 8  | 0.7              | 0.3                   | 7   | 5,214  |
| 9  | 0.9              | 0.6                   | 8   | 5,172  |
| 10   | 0.9              | 0.4                   | 11  | 5,323  |
| Average no. of function evaluations for the solution (419,000 units) |                  |                       |   | 4,750  |

where  $H_n$  = pressure head at node  $n$  and  $H_{\min}$  = minimum required pressure head.

The diameter of the pipes should be available from a set of commercial sizes:

$$D_i = [D], \quad \forall i \in NP \quad (5)$$

## DIFFERENTIAL EVOLUTION (DE) ALGORITHM

Storn & Price (1995) introduced the DEA, which basically resembles the structure of an evolutionary algorithm and differs in terms of the way in which mutation and crossover operators are applied to generate new

candidate solutions from standard evolutionary algorithms. Randomly selected candidate solutions (solution vectors) from the population are allowed to undergo the subtraction, addition and component swapping before reaching the next generation. DE performs mutation before crossover and mutation is treated as a constant, which acts as a weighting factor for the differential vector. The differential vector is obtained by finding the numerical difference between any two randomly selected solution vectors from the population or by taking the average of a number of differential vectors created from various randomly selected pairs from the population. This weighted difference vector is added with a third randomly chosen solution vector, which in turn creates

**Table 3** | Solutions for two-loop network

| Sl. no. | Authors                        | Technique used                | Average number of function evaluations |
|---------|--------------------------------|-------------------------------|--|
| 1       | Savic & Walters (1997)         | Genetic algorithm             | 65,000                                 |
| 2       | Cunha & Sousa (1999)           | Simulated annealing algorithm | 25,000                                 |
| 3       | Eusuff & Lansey (2003)         | Shuffled leapfrog algorithm   | 11,155                                 |
| 4       | Liong & Atiquzzaman (2004)     | Shuffled complex algorithm    | 1,019                                  |
| 5       | Neelakantan & Suribabu (2005)  | Modified genetic algorithm    | 2,440*                                 |
| 6       | Suribabu & Neelakantan (2006a) | Particle swarm optimization   | 5,138                                  |
| 7       | Present work                   | Differential evolution        | 4,750                                  |

\*Corresponds to the minimum number of function evaluations.

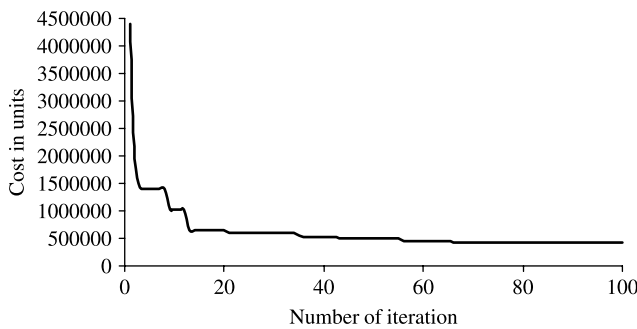

Figure 4 | Evolution process for two-loop network.

a new solution vector called a noisy vector. Now the crossover operation is performed between the noisy vector and target vector (from the population) to get a trial vector. Finally, the trial vector is compared with its target vector and the better one is passed to the next generation. The above-mentioned process gets repeated until the number of newly generated candidate solutions fills up the next generation. Figure 1 shows the steps involved in the differential evolution algorithm. It is to be noted that the randomly selected vectors should be distinctive from each other. It is interesting to note that DE does not use any selection mechanism as in GA; instead the lowest cost solution vector (in the case of the minimization problem) either from the trial vector or its parent target vector is allowed to advance to the next generation.

DE operates on a population  $P^{(G)}$  of generation  $G$  that contains  $n_{pop}$  candidate solutions (individuals). The position matrix of the population of generation  $G$  can be represented as

$$P^{(G)} = X_i^G \begin{bmatrix} x_{1,1}^G, x_{2,1}^G, x_{3,1}^G, \dots, x_{n_{pop},1}^G \\ x_{1,2}^G, x_{2,2}^G, x_{3,2}^G, \dots, x_{n_{pop},2}^G \\ x_{1,3}^G, x_{2,3}^G, x_{3,3}^G, \dots, x_{n_{pop},3}^G \\ \vdots \\ x_{1,n_{var}}^G, x_{2,n_{var}}^G, x_{3,n_{var}}^G, \dots, x_{n_{pop},n_{var}}^G \end{bmatrix} \quad (6)$$

where  $X_i^{(G)}$  is the  $i$ th candidate solution or individual in the  $G$ th generation,  $x_{ij}^{(G)}$  is the  $j$ th component (diameter of the  $j$ th link) of the  $i$ th candidate solution,  $n_{var}$  denotes the number of variables (in this case, the number of diameters to be selected) and  $G_{max}$  is the user-defined maximum number of generations.

The initial population  $P^{(0)}$  for the DE is created arbitrarily:

$$P^{(0)} = x_{ij}^{(0)} = x_j^{(L)} + \text{rand}_{ij} (x_j^{(U)} - x_j^{(L)}) \quad i = 1 \text{ to } n_{pop}, j = 1 \text{ to } n_{var} \quad (7)$$

where ‘rand<sub>ij</sub>’ denotes a uniformly distributed random value within the range [0.0 to 1.0].  $x_j^{(U)}$  and  $x_j^{(L)}$  are upper and lower limits of variable  $j$ .

From the first generation onwards, the population (new vectors) of the subsequent generation  $P^{(G+1)}$  is generated by the combination of vectors randomly chosen from the current population by mutation. The noisy vector is then mixed with the predetermined target vector.

The population of ‘trial’ vectors  $P^{(G+1)}$  is generated as follows (mutation and recombination):

$$x_{ij}^{G+1} = \begin{cases} x_{Cj}^{(G)} + F \times (x_{Aj}^{(G)} - x_{Bj}^{(G)}) & \text{if } \text{rand}_{ij} \leq C_r; \quad \forall j = D_i \\ x_{ij}^{(G)} & \text{otherwise} \end{cases} \quad (8)$$

where

$$D = 1, \dots, n_{param}$$

$$A \in [1, \dots, n_{pop}], \quad B \in [1, \dots, n_{pop}],$$

$$C \in [1, \dots, n_{pop}], \quad A \neq B \neq C \neq i,$$

$$C_r \in [0 \text{ to } 1], \quad F \in [0 \text{ to } 1], \quad \text{rand} \in [0 \text{ to } 1].$$

The weighting factor  $F$  is a user-defined mutation constant within the range [0 to 1].  $C_r$  is a user-defined

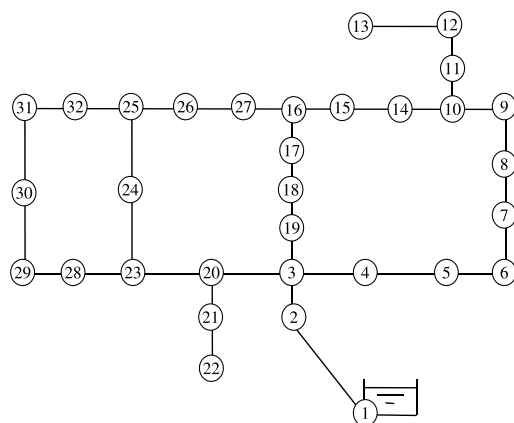

Figure 5 | Layout of example network 2 (Hanoi network).

**Table 4** | Node and link data for Hanoi network

| Node no. | Demand (m <sup>3</sup> /h) | Link index | Arc     | Length (m) |
|----------|----------------------------|------------|---------|------------|
| 1        | -19,940                    | 1          | (1,2)   | 100        |
| 2        | 890                        | 2          | (2,3)   | 1,350      |
| 3        | 850                        | 3          | (3,4)   | 900        |
| 4        | 130                        | 4          | (4,5)   | 1,150      |
| 5        | 725                        | 5          | (5,6)   | 1,450      |
| 6        | 1,005                      | 6          | (6,7)   | 450        |
| 7        | 1,350                      | 7          | (7,8)   | 850        |
| 8        | 550                        | 8          | (8,9)   | 850        |
| 9        | 525                        | 9          | (9,10)  | 800        |
| 10       | 525                        | 10         | (10,11) | 950        |
| 11       | 500                        | 11         | (11,12) | 1,200      |
| 12       | 560                        | 12         | (12,13) | 3,500      |
| 13       | 940                        | 13         | (10,14) | 800        |
| 14       | 615                        | 14         | (14,15) | 500        |
| 15       | 280                        | 15         | (15,16) | 550        |
| 16       | 310                        | 16         | (16,17) | 2,730      |
| 17       | 865                        | 17         | (17,18) | 1,750      |
| 18       | 1,345                      | 18         | (18,19) | 800        |
| 19       | 60                         | 19         | (19,3)  | 400        |
| 20       | 1,275                      | 20         | (3,20)  | 2,200      |
| 21       | 930                        | 21         | (20,21) | 1,500      |
| 22       | 485                        | 22         | (21,22) | 500        |
| 23       | 1,045                      | 23         | (20,23) | 2,650      |
| 24       | 820                        | 24         | (23,24) | 1,230      |
| 25       | 170                        | 25         | (24,25) | 1,300      |
| 26       | 900                        | 26         | (25,26) | 850        |
| 27       | 370                        | 27         | (26,27) | 300        |
| 28       | 290                        | 28         | (27,16) | 750        |
| 29       | 360                        | 29         | (23,28) | 1,500      |
| 30       | 360                        | 30         | (28,29) | 2,000      |
| 31       | 105                        | 31         | (29,30) | 1,600      |
| 32       | 805                        | 32         | (30,31) | 150        |
|          |                            | 33         | (31,32) | 860        |
|          |                            | 34         | (32,25) | 950        |

crossover constant, which assists in the differential perturbation to select the parameters either from the noisy vector or target vector to get the trial vector. Finally, the trial vector is carried to the next generation only if it yields a reduction in the value of the objective function in the case

**Table 5** | Cost data for pipes for Hanoi network

| Diameter (in) | Diameter (mm) | Cost (units) |
|---------------|---------------|--------------|
| 12            | 304.8         | 45.73        |
| 16            | 406.4         | 70.40        |
| 20            | 508.0         | 98.38        |
| 24            | 609.6         | 129.333      |
| 30            | 762.0         | 180.8        |
| 40            | 1016.0        | 278.3        |

of the minimization problem. Otherwise the target vector will be selected for the next generation.

The population of the next generation  $P^{(G+1)}$  is selected as follows:

$$x_{ij}^{G+1} = \begin{cases} x_{ij}^{(G+1)} & \text{if } f(x_i^{(G+1)}) \leq f(x_i^{(G)}) \\ x_{ij}^{(G)} & \text{otherwise} \end{cases} \quad (9)$$

where  $f(x_i^{(G)})$  represents the cost of the  $i$ th individual in the  $G$ th generation.

Figure 2 shows the computational modules of the differential evolution algorithms applicable to the optimal design of water distribution networks.

## APPLICATION

In the present study, a combined simulation-optimisation model is developed and used. The optimisation model is an outer driven whereas the simulation is an inner driven one. The computer programming code was written for DE using Visual Basic and EPANET (Rossman 2000) is linked via the EPANET Toolkit. The complete programme performs a hydraulic network analysis at each function evaluation to determine the pressure head at the nodes. The algorithm is applied to four well-known networks. A penalty value will be added to the solution vector that violates pressure at the node and it will be taken as the cost of the network forming links with maximum pipe size. The implementation strategy of DE for optimal design of the water distribution network is presented in Figure 2. It can be seen from Figure 2 that all the initial solution vectors consist of discrete pipe sizes. In the DE process, these discrete sizes will be converted to continuous

**Table 6** | Results of ten trial runs for Hanoi network

| Trial run number   | Weighting factor | Crossover probability | Number of times the least cost solution obtained (out of 5 trials) | Average number of function evaluation in getting least cost solution |
|--|------------------|-----------------------|--|--|
| 1  | 0.8              | 0.5                   | 5  | 50,840   |
| 2  | 0.8              | 0.4                   | 4  | 60,075   |
| 3  | 0.7              | 0.5                   | 5  | 33,400   |
| 4  | 0.7              | 0.4                   | 5  | 62,460   |
| 5  | 0.6              | 0.5                   | 3  | 32,800   |
| 6  | 0.6              | 0.4                   | 3  | 46,700   |
| 7  | 0.9              | 0.5                   | 5  | 48,260   |
| 8  | 0.9              | 0.4                   | 4  | 43,400   |
| 9  | 0.8              | 0.3                   | 2  | 64,300   |
| 10   | 0.9              | 0.6                   | 5  | 45,000   |
| Average no. of function evaluations for the solution (6,081,087 units) |                  |                       |  | 48,724   |

diameter when it undergoes the mutation process. From the initial population, two solution vectors are randomly selected and the difference between each of the parameters is determined. The weighted vector is obtained by multiplying by the mutation constant and it is added to the third randomly selected vector from the initial population to get a noisy vector. Furthermore, a new solution vector is obtained by performing crossover, which basically selects the pipe diameter either from the noisy vector or target vector, according to the selection probability. The selection probability is randomly generated in order to compare with the crossover constant. If it is less than or equal to the crossover constant, the pipe diameter is selected from the noisy vector, otherwise from the target vector. The overall cost of the new solution (called a trial vector) is calculated after converting the pipe diameters selected from the noisy vector to the nearest commercial size. As this conversion of continuous diameter to discrete diameter occurs within the optimisation (i.e. before the selection of the vector for the next generation), this does not affect the goal of optimisation.

### Example 1 (two-loop network)

The pipe network in this example (Figure 3) is a hypothetical problem drawn from Alperovits & Shamir (1977). The network consists of eight links, six demand

nodes and a reservoir. All the links of the network has a length of 1,000 m each and the Hazen–Williams coefficient is considered as 130 for all the links. The minimum pressure head requirement for all the nodes is 30 m. Table 1 shows the commercially available pipes and their cost per metre length. Thirty trial runs are performed with different initial random seeds, for each set of selected operator constants by setting a population size as 20. The mutation constant is varied from 0.6–0.9 in 0.1 increments and similarly the crossover constant is varied from 0.3–0.5 in increments of 0.1. Ten different combinations of constants are considered from the above range. The termination criterion for the optimisation is arbitrarily set to 500 generations. As the population size is set to twenty, each generation consists of 20 function evaluations. Table 2 provides the results of an average of 30 trial runs for each combination of constants. From the trials, the least cost of 419,000 units is found out with an average probability of success of 40%, i.e. out of 300 trials, 120 times a least cost of 419,000 is obtained. The same is reported in the literature too (Savic & Walters 1997; Cunha & Sousa 1999; Eusuff & Lansey 2003; Liang & Atiquzzaman 2004; Suribabu & Neelakantan 2006a,b). The average number of function evaluations corresponding to the least cost is determined as 4,750. In the evaluation process, one of the trials having a weighting factor of 0.6 and crossover constant of 0.5 has provided an optimal solution of 419,000 units at the expense of 1,320 function evaluations. The optimal diameters for links 1–8 are found



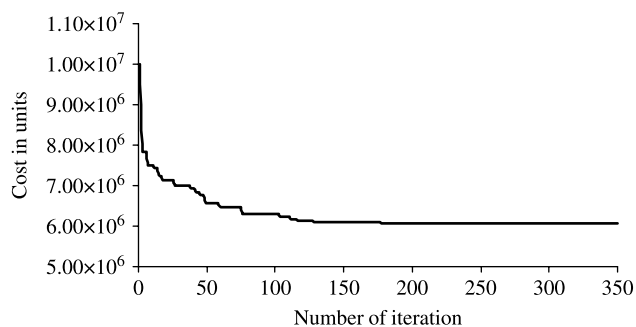

**Figure 6** | Evolution process for Hanoi network.

as 457.2, 254, 406.4, 101.6, 406.4, 254, 254 and 25.4 mm, respectively. The CPU time taken for running the module using a PC IV 65 MHz, 98 MB RAM for a maximum of 10,000 function evaluations is 2 s. Further, by setting the population size as 100, while the maximum permitted generations was 500, ten trial runs were carried out with ten different combinations of constants. It is to be noted that the least cost of the 419,000 units is determined at the first instant of every trial run. The average number of function evaluations taken to obtain the least cost is 23,000, while the population size is 100. This ensures that DE performs well in searching for an optimal solution for this example without getting trapped in a local minimum value. The computation time taken for 50,000 function evaluations is 7 s. Table 3 presents the average number of

function evaluations reported in the literature for obtaining the least cost of 419,000 units. Figure 4 shows an evolution process for a two-loop network corresponding to the least number of function evaluations obtained in the trial runs.

### Example 2 (Hanoi network)

The second test network (Figure 5) is a three-loop water distribution network of the Hanoi city water distribution system, which consists of thirty-two nodes, thirty-four pipes and a reservoir. The input data for this problem is given in Fujiwara & Khang (1990) and is presented in Tables 4 and 5. The design of this network is restricted to selecting six different diameter pipes assumed to be commercially available (Table 5). The minimum pressure head requirement for all the nodes is set at 30 m. The solution space consists of  $6^{34}$  numbers of solutions, as there are 6 possible pipe diameters and 34 links in the system. Similar to the previous case study, 300 trial runs are performed by keeping the population size as 20 with weighting factors ranging from 0.6–0.9 (mutation rate) and crossover constant ranging from 0.3–0.5. The termination criterion for the algorithm is arbitrarily set to 500 generations. In each combination of constants, 30 trials are performed with different initial random seeds. The network solution having a least cost of \$60,81,087 was obtained 62 times out of

**Table 7** | Solutions for Hanoi network

| Authors                        | Algorithm                       | Number of function evaluation | Cost (units) |
|--------------------------------|---------------------------------|-------------------------------|--------------|
| Savic & Walter (1997)          | Genetic algorithm               | 1,000,000                     | 6,073,000    |
| Cunha & Sousa (1999)           | Simulated annealing algorithm   | 53,000                        | 6,056,000    |
| Geem <i>et al.</i> (2002)      | Harmony search                  | 200,000                       | 6,056,000    |
| Eusuff & Lansey (2003)         | Shuffled frog leaping algorithm | 26,987                        | 6,073,000    |
| Liong & Atiquzzaman (2004)     | Shuffled complex algorithm      | 25,402                        | 6,220,000    |
| Neelakantan & Suribabu (2005)  | Standard GA                     | 1,234,340*                    | 6,081,087    |
| Neelakantan & Suribabu (2005)  | Modified GA                     | 74,500*                       | 6,081,087    |
| Vairavamoorthy & Ali (2005)    | Genetic algorithm               | 18,300                        | 6,056,000    |
|                                | Pipe index vector               |                               |              |
| Suribabu & Neelakantan (2006b) | Particle swarm optimization     | 6,600*                        | 6,081,087    |
| Kadu <i>et al.</i> (2008)      | Modified GA 1                   | 18,000                        | 6,056,000    |
| Kadu <i>et al.</i> (2008)      | Modified GA 2                   | 18,000                        | 6,190,000    |
| Present work                   | Differential evolution          | 48,724                        | 6,081,087    |

\*Correspond to the minimum number of function evaluations.

**Table 8** | Pipe diameter (mm) and nodal pressure heads (m) for solutions of Hanoi network obtained using EPANET version 2

| Pipe/node no. | Network cost    |           |                 |           |                 |           |                 |           |
|---------------|-----------------|-----------|-----------------|-----------|-----------------|-----------|-----------------|-----------|
|               | \$6.056 million |           | \$6.073 million |           | \$6.081 million |           | \$6.220 million |           |
|               | Dia. (mm)       | Pres. (m) | Dia. (mm)       | Pres. (m) | Dia. (mm)       | Pres. (m) | Dia. (mm)       | Pres. (m) |
| 1             | 1,016           | 100.00    | 1,016           | 100.00    | 1,016           | 100.00    | 1,016           | 100.00    |
| 2             | 1,016           | 97.14     | 1,016           | 97.14     | 1,016           | 97.14     | 1,016           | 97.14     |
| 3             | 1,016           | 61.67     | 1,016           | 61.67     | 1,016           | 61.67     | 1,016           | 61.67     |
| 4             | 1,016           | 56.87     | 1,016           | 56.88     | 1,016           | 56.92     | 1,016           | 57.54     |
| 5             | 1,016           | 50.92     | 1,016           | 50.94     | 1,016           | 51.02     | 1,016           | 52.43     |
| 6             | 1,016           | 44.64     | 1,016           | 44.68     | 1,016           | 44.81     | 1,016           | 47.13     |
| 7             | 1,016           | 43.16     | 1,016           | 43.21     | 1,016           | 43.35     | 1,016           | 45.92     |
| 8             | 1,016           | 41.39     | 1,016           | 41.45     | 1,016           | 41.61     | 762             | 44.55     |
| 9             | 1,016           | 39.98     | 1,016           | 40.04     | 1,016           | 40.23     | 762             | 40.27     |
| 10            | 762             | 38.93     | 762             | 39.00     | 762             | 39.20     | 762             | 37.24     |
| 11            | 609.6           | 37.37     | 609.6           | 37.44     | 609.6           | 37.64     | 762             | 35.65     |
| 12            | 609.6           | 33.94     | 609.6           | 34.01     | 609.6           | 34.21     | 609.6           | 34.52     |
| 13            | 508             | 29.74*    | 508             | 29.80*    | 508             | 30.01     | 406.4           | 30.32     |
| 14            | 406.4           | 35.01     | 406.4           | 35.13     | 406.4           | 35.52     | 304.8           | 34.08     |
| 15            | 304.8           | 32.95     | 304.8           | 33.14     | 304.8           | 33.72     | 304.8           | 34.08     |
| 16            | 304.8           | 29.87*    | 304.8           | 30.23     | 304.8           | 31.30     | 609.6           | 36.13     |
| 17            | 406.4           | 30.03     | 406.4           | 30.32     | 406.4           | 33.41     | 762             | 48.64     |
| 18            | 508             | 43.87     | 508             | 43.97     | 609.6           | 49.93     | 762             | 54.00     |
| 19            | 508             | 55.54     | 508             | 55.58     | 508             | 55.09     | 762             | 59.07     |
| 20            | 1,016           | 50.49     | 1,016           | 50.44     | 1,016           | 50.61     | 1,016           | 53.62     |
| 21            | 508             | 41.14     | 508             | 41.09     | 508             | 41.26     | 508             | 44.27     |
| 22            | 304.8           | 35.97     | 304.8           | 55.93     | 304.8           | 36.10     | 304.8           | 39.11     |
| 23            | 1,016           | 44.30     | 1,016           | 44.21     | 1,016           | 44.52     | 762             | 38.79     |
| 24            | 762             | 38.57     | 762             | 38.90     | 762             | 38.93     | 762             | 36.37     |
| 25            | 762             | 34.86     | 762             | 35.55     | 762             | 35.34     | 609.6           | 33.16     |
| 26            | 508             | 30.95     | 508             | 31.53     | 508             | 31.70     | 304.8           | 33.44     |
| 27            | 304.8           | 29.66*    | 304.8           | 30.11     | 304.8           | 30.76     | 508             | 34.38     |
| 28            | 304.8           | 38.66     | 304.8           | 35.50     | 304.8           | 38.94     | 609.6           | 32.64     |
| 29            | 406.4           | 29.72*    | 406.4           | 30.75     | 406.4           | 30.13     | 406.4           | 30.05     |
| 30            | 304.8           | 29.98*    | 406.4           | 29.73*    | 304.8           | 30.42     | 406.4           | 30.10     |
| 31            | 304.8           | 30.26     | 304.8           | 30.19     | 304.8           | 30.70     | 304.8           | 30.35     |
| 32            | 406.4           | 32.72     | 304.8           | 31.44     | 406.4           | 33.18     | 406.4           | 31.09     |
| 33            | 406.4           |           | 406.4           |           | 406.4           |           | 508             |           |
| 34            | 609.6           |           | 508             |           | 609.6           |           | 609.6           |           |

\*Nodal pressure head less than required minimum pressure head of 30 m.

300 trials. Further, by increasing the population size to 100 and restricting the maximum generation to 1,000, 50 trial runs are performed for ten different combinations of constants and it is observed that most of the time, the least cost

solution is obtained within the first five trial runs for each combination of constants. It is to be noted from Table 6 that, out of 50 trials, 41 times a least cost of \$6,081,087 is obtained. The computational times taken for the

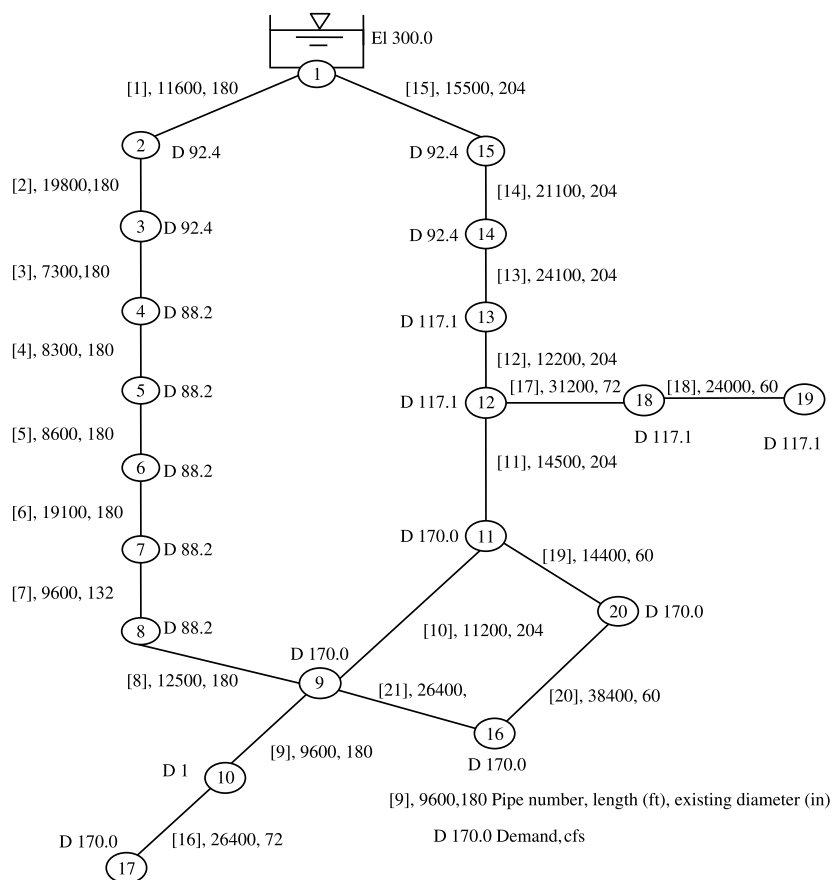

Figure 7 | New York City water supply tunnels.

maximum of 10,000 and 100,000 function evaluations are 6 and 52 s, respectively. The average number of function evaluations is determined as 6,244 and 48,724 for population sizes of 20 and 100, respectively. This clearly shows that population size plays a vital role in obtaining the optimal solution with a certain degree of confidence. From the trial runs, one run provides a least cost at the expense of 3,540 function evaluations and corresponding mutation and crossover constants are 0.6 and 0.4, respectively. Figure 6 shows the evolution process for the Hanoi network corresponding to the least function evaluations obtained in the trial runs. The results obtained using DE and those previously reported in the literature are shown in Table 7. The obtained solution cost is higher than the cost reported in the notable literature (Savic & Walter 1997; Cunha & Sousa 1999; Vairavamoorthy & Ali 2005). This variation in the cost of the solutions is due to the use of different  $\alpha$  values. Table 8 shows the optimal diameter and the nodal

Table 9 | Available pipe diameters and their associated unit length costs

| Diameter (in) | Pipe cost (\$/ft) |
|---------------|-------------------|
| 0             | 0.0               |
| 36            | 93.5              |
| 48            | 134.0             |
| 60            | 176.0             |
| 72            | 221.0             |
| 84            | 267.0             |
| 96            | 316.0             |
| 108           | 365.0             |
| 120           | 417.0             |
| 132           | 469.0             |
| 144           | 522.0             |
| 156           | 577.0             |
| 168           | 632.0             |
| 180           | 689.0             |
| 192           | 746.0             |
| 204           | 804.0             |

**Table 10** | Results of the trial runs for New York City network

| Trial run no   | Weighting factor | Crossover probability | Number of times the least cost solution obtained (out of 30 trials) | Average number of function evaluation in getting least cost solution |
|--|------------------|-----------------------|---|--|
| 1  | 0.8              | 0.5                   | 22  | 3,974  |
| 2  | 0.8              | 0.4                   | 24  | 6,870  |
| 3  | 0.8              | 0.3                   | 19  | 7,820  |
| 4  | 0.7              | 0.5                   | 23  | 6,340  |
| 5  | 0.7              | 0.4                   | 16  | 4,780  |
| 6  | 0.7              | 0.3                   | 17  | 5,485  |
| 7  | 0.6              | 0.5                   | 19  | 3,866  |
| 8  | 0.6              | 0.4                   | 28  | 6,420  |
| 9  | 0.9              | 0.5                   | 24  | 4,504  |
| 10   | 0.7              | 0.6                   | 20  | 4,885  |
| Average no. of function evaluations for the solution (\$38.64 million) |                  |                       |   | 5,494  |

**Table 11** | Optimal diameter (in inches) for parallel pipelines for New York City tunnel expansion problem

| Pipe       | Savic & Walters (1997) | Lippai <i>et al.</i> (1999) | Montesinos <i>et al.</i> (1999) | Wu <i>et al.</i> (2001) | Maier <i>et al.</i> (2003) | Eusuff & Lansey (2003) | Present work |
|------------|------------------------|-----------------------------|---------------------------------|-------------------------|----------------------------|------------------------|--------------|
| 1          | 0                      | 0                           | 0                               | 0                       | 0                          | 0                      | 0            |
| 2          | 0                      | 0                           | 0                               | 0                       | 0                          | 0                      | 0            |
| 3          | 0                      | 0                           | 0                               | 0                       | 0                          | 0                      | 0            |
| 4          | 0                      | 0                           | 0                               | 0                       | 0                          | 0                      | 0            |
| 5          | 0                      | 0                           | 0                               | 0                       | 0                          | 0                      | 0            |
| 6          | 0                      | 0                           | 0                               | 0                       | 0                          | 0                      | 0            |
| 7          | 108                    | 132                         | 0                               | 108                     | 144                        | 132                    | 144          |
| 8          | 0                      | 0                           | 0                               | 0                       | 0                          | 0                      | 0            |
| 9          | 0                      | 0                           | 0                               | 0                       | 0                          | 0                      | 0            |
| 10         | 0                      | 0                           | 0                               | 0                       | 0                          | 0                      | 0            |
| 11         | 0                      | 0                           | 0                               | 0                       | 0                          | 0                      | 0            |
| 12         | 0                      | 0                           | 0                               | 0                       | 0                          | 0                      | 0            |
| 13         | 0                      | 0                           | 0                               | 0                       | 0                          | 0                      | 0            |
| 14         | 0                      | 0                           | 0                               | 0                       | 0                          | 0                      | 0            |
| 15         | 0                      | 0                           | 120                             | 0                       | 0                          | 0                      | 0            |
| 16         | 96                     | 96                          | 84                              | 96                      | 96                         | 96                     | 96           |
| 17         | 96                     | 96                          | 96                              | 96                      | 96                         | 96                     | 96           |
| 18         | 84                     | 84                          | 84                              | 84                      | 84                         | 84                     | 84           |
| 19         | 72                     | 72                          | 72                              | 72                      | 72                         | 72                     | 72           |
| 20         | 0                      | 0                           | 0                               | 0                       | 0                          | 0                      | 0            |
| 21         | 72                     | 72                          | 72                              | 72                      | 72                         | 72                     | 72           |
| Cost*      | 37.13 <sup>†</sup>     | 38.13 <sup>†</sup>          | 38.80                           | 37.13 <sup>†</sup>      | 38.64                      | 38.13 <sup>†</sup>     | 38.64        |
| Avg. Eval. |                        | 46,016                      | 18,450                          | 37,186                  | 13,928                     | 13,928                 | 5,494        |

0 indicate no parallel line required.

\*Cost in \$ million.

<sup>†</sup>Nodal pressure head is less than required minimum.

**Table 12** | Nodal pressure heads (ft) for solutions of New York City water supply network obtained using EPANET version 2

| Pipe/Node no. | Network cost    |                 |                 |                 |
|---------------|-----------------|-----------------|-----------------|-----------------|
|               | \$37.13 million | \$38.13 million | \$38.64 million | \$38.80 million |
| 1             | 300.00          | 300.00          | 300.00          | 300.00          |
| 2             | 294.27          | 294.23          | 294.21          | 294.63          |
| 3             | 286.32          | 286.20          | 286.15          | 287.23          |
| 4             | 283.99          | 283.84          | 283.79          | 285.08          |
| 5             | 281.93          | 281.76          | 281.70          | 283.21          |
| 6             | 280.34          | 280.15          | 280.07          | 281.79          |
| 7             | 277.84          | 277.61          | 277.51          | 279.60          |
| 8             | 276.27          | 276.56          | 276.67          | 276.47          |
| 9             | 273.49          | 273.70          | 273.78          | 274.27          |
| 10            | 273.46          | 273.66          | 273.74          | 274.24          |
| 11            | 273.59          | 273.79          | 273.87          | 274.41          |
| 12            | 274.89          | 275.07          | 275.14          | 275.86          |
| 13            | 277.89          | 278.04          | 278.10          | 279.06          |
| 14            | 285.43          | 285.53          | 285.56          | 287.05          |
| 15            | 293.27          | 293.31          | 293.33          | 295.31          |
| 16            | 259.79*         | 260.00          | 260.08          | 260.59          |
| 17            | 273.40          | 273.60          | 273.68          | 274.18          |
| 18            | 260.93          | 261.11          | 261.18          | 261.91          |
| 19            | 254.80*         | 254.98*         | 255.05          | 255.78          |
| 20            | 260.45          | 260.65          | 260.73          | 261.26          |

\*Nodal pressure is less than required minimum.

pressure heads for the solutions having costs of \$6.056, \$6.073, \$6.081 and \$6.220 million while analysing using EPANET version 2. It can be seen from Table 8 that the minimum required pressure head (30 m) is not satisfied at a few nodes for the solutions having costs of \$6.056 and \$6.073 million.

### Example 3 (New York City water supply system)

The New York City water supply system as presented by Schaake & Lai (1969) is a gravity flow system that draws water from a single source (the Hill View Reservoir), which is shown in Figure 7. This problem requires a parallel expansion, since the existing facilities could not satisfy all the water demands at the required nodal pressures. One of the ways to resolve this situation is by installing new pipes parallel to the existing ones; hence the optimisation problem consists of determining the diameter of the new pipes so that the expansion cost is minimised. The geometric data and demand at each node are presented along with the layout of the network (Figure 7). For all new and existing pipes a Hazen–Williams roughness coefficient equal to 100 is considered. The minimum allowable hydraulic gradient line at all nodes is 255.0 ft, except for nodes 16 and 17 for which these values are 260.0 ft and 272.8 ft, respectively.

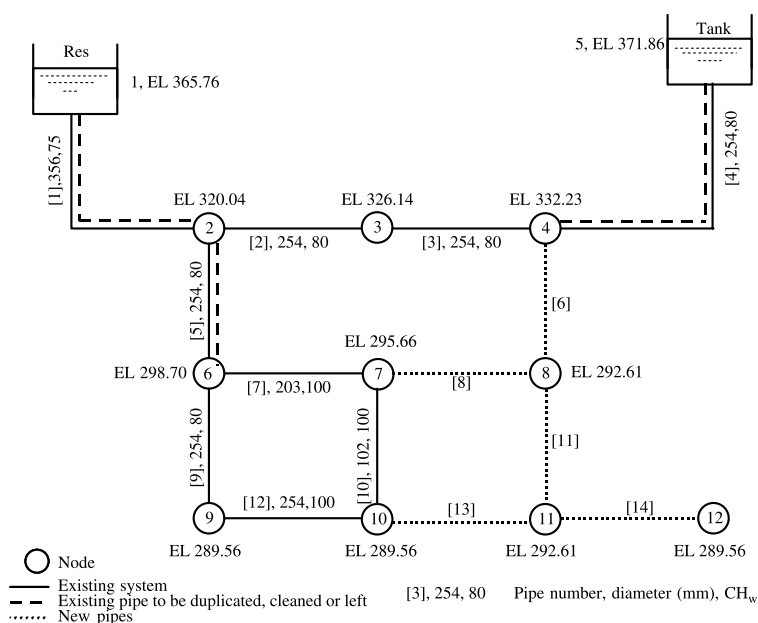
**Figure 8** | Fourteen-pipe network expansion problem.

**Table 13** | Available pipe sizes and associated costs for the 14-pipe network

| Pipe diameter (mm) | Cost for a new pipe (\$/m) | Cost for cleaning a pipe (\$/m) |
|--------------------|----------------------------|---------------------------------|
| 152                | 49.54                      | 47.57                           |
| 203                | 63.32                      | 51.51                           |
| 254                | 94.82                      | 55.12                           |
| 305                | 132.87                     | 58.07                           |
| 356                | 170.93                     | 60.70                           |
| 407                | 194.88                     | 63.00                           |
| 458                | 232.94                     | –                               |
| 509                | 264.10                     | –                               |

Table 9 provides the set of allowable diameters and their associated unit length costs as available in the year 1969, so that comparisons can be made with previous studies. By limiting the maximum number of generations to 500, 30 trial runs are performed with different initial random seeds for ten different combinations of DE constants by setting the population size as 20. The results of the trial runs are presented in Table 10. It can be seen that, out of 300 trial runs, 212 trials gave a solution cost of \$38.64 million with an average number of function evaluations of 5,494. From the trial runs, one run provides a least cost at the expense of 3,220 function evaluations and the corresponding mutation and crossover constants are 0.6 and 0.5, respectively. The CPU time taken for 10,000 function evaluations is 3 s. Maier *et al.* (2003) presented a solution with the same cost as found in the present study with an

average function evaluation of 13,928. Table 11 provides a comparison of optimal diameter for parallel pipes with those reported in the literature. The nodal pressure head for the solutions having costs \$37.13, \$38.13, \$38.64 and \$38.80 million are summarised in Table 12 for comparison. It is found that the pressure head for solutions having costs of \$38.64 and \$38.80 million are above the minimum required values, while analysing using EPANET version 2.

#### Example 4 (14-pipe network)

This example network consists of two supply sources (a reservoir and a tank) with 14 pipes. This network needs expansion as well as possible rehabilitation of three pipes in order to satisfy the three-demand pattern and associated minimum pressure. Out of 14 pipes, the diameters of 5 pipes are to be newly selected from commercially available sizes; three existing pipes may be cleaned, duplicated or left alone. Figure 8 shows solid lines representing the existing system and dashed lines depicting the new pipes. Elevations, pipe lengths, diameters and Hazen–Williams coefficients are also given in Figure 8. The length of all the pipes is 1,609 m except for pipes 1 and 4 whose lengths are 4,828 m and 6,437 m, respectively. Table 13 shows the pipe costs and available diameters. Three demand patterns (including two fire loading cases) and the associated minimum pressure heads are given in Table 14. By changing DE parameters, 300 trial runs are performed with a population size of

**Table 14** | Demand patterns and associated minimum allowable pressures for the 14-pipe network

| Node | Demand pattern 1 |                                     | Demand pattern 2 |                                     | Demand pattern 3 |                                     |
|------|------------------|-------------------------------------|------------------|-------------------------------------|------------------|-------------------------------------|
|      | Demand (L/s)     | Minimum allowable pressure head (m) | Demand (L/s)     | Minimum allowable pressure head (m) | Demand (L/s)     | Minimum allowable pressure head (m) |
| 2    | 12.62            | 28.18                               | 12.62            | 14.09                               | 12.62            | 14.09                               |
| 3    | 12.62            | 17.61                               | 12.62            | 14.09                               | 12.62            | 14.09                               |
| 4    | 0.00             | 17.61                               | 0.00             | 14.09                               | 0.00             | 14.09                               |
| 6    | 18.93            | 35.22                               | 18.93            | 14.09                               | 18.93            | 14.09                               |
| 7    | 18.93            | 35.22                               | 82.03            | 10.57                               | 18.93            | 14.09                               |
| 8    | 18.93            | 35.22                               | 18.93            | 14.09                               | 18.93            | 14.09                               |
| 9    | 12.62            | 35.22                               | 12.62            | 14.09                               | 12.62            | 14.09                               |
| 10   | 18.93            | 35.22                               | 18.93            | 14.09                               | 18.93            | 14.09                               |
| 11   | 18.93            | 35.22                               | 18.93            | 14.09                               | 18.93            | 14.09                               |
| 12   | 12.62            | 35.22                               | 12.62            | 14.09                               | 50.48            | 10.57                               |

**Table 15** | Results of the trial runs for 14-pipe network

| Trial run number  | Weighting factor | Crossover probability | Number of times the least cost solution obtained (out of 30 trials) | Evaluation number |
|---|------------------|-----------------------|---|-------------------|
| 1   | 0.9              | 0.5                   | 21  | 1,368             |
| 2   | 0.9              | 0.4                   | 23  | 1,448             |
| 3   | 0.8              | 0.5                   | 22  | 1,234             |
| 4   | 0.8              | 0.4                   | 25  | 1,456             |
| 5   | 0.7              | 0.5                   | 24  | 1,222             |
| 6   | 0.7              | 0.4                   | 25  | 916               |
| 7   | 0.6              | 0.5                   | 29  | 1,750             |
| 8   | 0.6              | 0.4                   | 26  | 1,122             |
| 9   | 0.5              | 0.5                   | 22  | 1,790             |
| 10  | 0.5              | 0.4                   | 22  | 1,670             |
| Average no. of function evaluations for the solution (\$1.75 million) |                  |                       |   | 1,398             |

**Table 16** | Solutions for 14-pipe expansion problem

| Pipe                     | Simpson <i>et al.</i> (1994) | Wu & Simpson (1996) | Maier <i>et al.</i> (2003) | Present work |
|--------------------------|------------------------------|---------------------|----------------------------|--------------|
| 1                        | Leave                        | Leave               | Leave                      | Leave        |
| 4                        | Dup 356                      | Dup 356             | Dup 356                    | Dup 356      |
| 5                        | Leave                        | Leave               | Leave                      | Leave        |
| 6                        | 305                          | 305                 | 305                        | 305          |
| 8                        | 203                          | 203                 | 203                        | 203          |
| 11                       | 203                          | 203                 | 203                        | 203          |
| 13                       | 152                          | 152                 | 152                        | 152          |
| 14                       | 254                          | 254                 | 254                        | 254          |
| Cost (\$ million)        | 1.750                        | 1.750               | 1.750                      | 1.750        |
| Avg. function evaluation | 20,790                       | 6,181               | 8,509                      | 1,398        |

Leave—No change in status of existing pipe.

Dup—Providing a new parallel pipe while retaining existing pipe as it is.

**Table 17** | Allowable and actual pressure heads (m) for optimal solution

| Node | Demand pattern 1   |                                   | Demand pattern 2   |                                   | Demand pattern 3   |                                   |
|------|--------------------|-----------------------------------|--------------------|-----------------------------------|--------------------|-----------------------------------|
|      | $H_{\text{allow}}$ | $H_{\text{act}}$ (\$1.75 million) | $H_{\text{allow}}$ | $H_{\text{act}}$ (\$1.75 million) | $H_{\text{allow}}$ | $H_{\text{act}}$ (\$1.75 million) |
| 2    | 28.18              | 36.33                             | 14.09              | 25.05                             | 14.09              | 30.56                             |
| 3    | 17.61              | 30.51                             | 14.09              | 19.42                             | 14.09              | 24.60                             |
| 4    | 17.61              | 26.90                             | 14.09              | 16.26                             | 14.09              | 20.54                             |
| 6    | 35.22              | 46.92                             | 14.09              | 18.75                             | 14.09              | 34.42                             |
| 7    | 35.22              | 50.09                             | 10.57              | 12.78                             | 14.09              | 37.61                             |
| 8    | 35.22              | 59.31                             | 14.09              | 41.44                             | 14.09              | 48.05                             |
| 9    | 35.22              | 51.92                             | 14.09              | 24.12                             | 14.09              | 34.70                             |
| 10   | 35.22              | 49.83                             | 14.09              | 22.41                             | 14.09              | 26.73                             |
| 11   | 35.22              | 47.57                             | 14.09              | 24.91                             | 14.09              | 18.26                             |
| 12   | 35.22              | 50.03                             | 14.09              | 27.37                             | 10.57              | 13.70                             |

20 and limiting number of generations as 500. The minimum cost solution (\$1.750 million) was obtained 239 times out of 300 trial runs. Table 15 shows the results of trial runs. From the trial runs, one trial provides a least cost at the expense of 916 function evaluations and corresponding mutation and crossover constants are 0.7 and 0.4, respectively. The CPU time taken for 10,000 function evaluations is 2 s. Table 16 provides the optimal solution obtained using the DE algorithm and those reported in the literature. Table 17 shows the comparative picture of expected and actual pressure head for three demand patterns. From the results of the benchmark networks, it is evident that DE can be one of the promising algorithms for optimal sizing and rehabilitation of water distribution networks.

## CONCLUSION

The present paper has focused on the application of the DE algorithm for optimal design and rehabilitation of existing water distribution networks. The optimal network design is computationally complex and they generally belong to a group of NP-hard problems. In the present research work, the efficiency of DE is tested with four well-known benchmark networks, which are often reported in the literature. Results reveal that the DE technique is very effective in finding near-optimal or optimal solutions, within a fair number of function evaluations. There are many developments taking place in genetic algorithms and simulated annealing algorithms for handling large-sized water distribution system design. Compared to these algorithms, DE works distinctly well. From the trial runs, it is understood that the effectiveness of DE is due to the use of the weighted difference vector between two individuals and a third individual, which provides the basis for exploring better directions in the search space. The role of randomness in DE is relatively less while compared to the genetic algorithm and other heuristic algorithms like simulated annealing, particle swarm optimisation, ant colony algorithm and shuffled leapfrog algorithm. The DE parameters used in the case study problems are selected arbitrarily and, like all heuristics, the best parameter values are problem-dependent.

## ACKNOWLEDGEMENTS

The author wishes to express his gratitude to SASTRA University for providing facilities for the present research work. The author is also grateful to the anonymous reviewers whose comments helped in improving the quality of the paper significantly.

## REFERENCES

- Alperovits, E. & Shamir, U. 1977 Design of optimal water distribution systems. *Water Resour. Res.* **13** (6), 885–900.
- Babu, B. V. & Angira, R. 2003 Optimization of water pumping system using differential evolution strategies. In: *Proceedings of the Second International Conference on Computational Intelligence, Robotics, and Autonomous Systems (CIRAS-2003)*, Singapore pp. 25–30.
- Bhave, P. R. & Sonak, V. V. 1992 A critical study of the linear programming gradient method for optimal design of water supply networks. *Water Resour. Res.* **28** (6), 1577–1584.
- Cunha, M. & Sousa, J. 1999 Water distribution network design optimization: simulated annealing approach. *J. Water Resour. Plann. Manage.* **125** (4), 215–221.
- Dandy, G. C., Simpson, A. R. & Murphy, L. J. 1996 An improved genetic algorithm for pipe network optimization. *Water Resour. Res.* **32** (2), 449–458.
- Eusuff, M. M. & Lansey, K. E. 2003 Optimization of water distribution network design using the shuffled frog leaping algorithm. *J. Water Resour. Plann. Manage.* **129** (3), 210–225.
- Fujiwara, O. & Khang, D. B. 1990 A two-phase decomposition method for optimal design of looped water distribution networks. *Water Resour. Res.* **27** (5), 985–986.
- Fujiwara, O., Jenchaimahakoon, B. & Edirisinghe, N. C. P. 1987 A modified linear programming gradient method for optimal design of looped water distribution networks. *Water Resour. Res.* **23** (6), 977–982.
- Geem, Z. W., Kim, J. H. & Loganathan, G. V. 2002 Harmony search optimization: application to pipe network design. *Int. J. Modell. Simul.* **22** (2), 125–133.
- Goulter, I. C., Lussier, B. M. & Morgan, D. R. 1986 Implications of head loss path choice in the optimization of water distribution networks. *Water Resour. Res.* **22** (5), 819–822.
- Jacoby, S. L. S. 1968 Design of optimal hydraulic networks. *J. Hydraul. Div.* **94** (3), 641–661.
- Janga Reddy, M. & Nagesh Kumar, D. 2007 Multi-objective differential evolution with application to reservoir system optimization. *J. Comput. Civil Eng.* **21** (2), 136–146.
- Kadu, M. S., Rajesh, G. & Bhave, P. R. 2008 Optimal design of water networks using a modified genetic algorithm with reduction in search space. *J. Water Resour. Plann. Manage.* **134** (2), 147–160.



- Keedwell, E. & Khu, S.-T. 2006 Novel cellular automata approach to optimal water distribution network design. *J. Comput. Civil Eng.* **20** (1), 49–56.
- Kessler, A. & Shamir, U. 1989 Analysis of linear programming gradient method for optimal design of water supply networks. *Water Resour. Res.* **25** (7), 1469–1480.
- Liong, S. Y. & Atiquzzaman, M. 2004 Optimal design of water distribution network using shuffled complex evolution. *J. Inst. Eng., Singapore* **44** (1), 93–107.
- Lippai, I., Heany, J. P. & Laguna, M. 1999 Robust water system design with commercial intelligent search optimizers. *J. Comput. Civil Eng.* **13** (3), 135–143.
- Maier, H. R., Simpson, A. R., Zecchin, A. C., Foong, W. K., Phang, K. Y., Seah, H. Y. & Tan, C. L. 2003 Ant colony optimization for design of water distribution systems. *J. Water Resour. Plann. Manage.* **129** (3), 200–209.
- Montesinos, P., Guzman, A. G. & Ayuso, J. L. 1999 Water distribution network optimization using a modified genetic algorithm. *Water Resour. Res.* **35** (11), 3467–3473.
- Neelakantan, T. R. & Suribabu, C. R. 2005 Optimal design of water distribution networks by a modified genetic algorithm. *J. Civil Environ. Eng.* **1** (1), 20–34.
- Ostfeld, A. & Tubaltzev, A. 2008 Ant colony optimization for least cost design and operation of pumping and operation of pumping water distribution systems. *J. Water Resour. Plann. Manage.* **134** (2), 107–118.
- Pitchai, R. 1966 *A Model for Designing Water Distribution Pipe Networks*. PhD Thesis, Harvard University, Cambridge, MA.
- Quindry, G., Brill, E. D. & Lienman, J. 1979 *Water Distribution System Design Criteria*. Department of Civil Engineering, University of Illinois at Urbana-Champaign, Urbana, IL.
- Rossman, L. A. 2000 *EPANET 2- User Manual*. National Risk Management Research Laboratory, Office of Research and Development, US Environmental Protection Agency, Cincinnati, OH.
- Savic, D. A. & Walters, G. A. 1997 Genetic algorithms for least cost design of water distribution networks. *J. Water Resour. Plann. Manage.* **123** (2), 67–77.
- Schaake, J. C. & Lai, D. 1969 *Linear Programming and Dynamic Programming Applications to Water Distribution Network Design*. Report 116, Hydrodynamics Laboratory, Department of Civil Engineering, MIT, Cambridge, MA.
- Simpson, A. R., Dandy, G. C. & Murphy, L. J. 1994 Genetic algorithm compared to other techniques for pipe optimization. *J. Water Resour. Plann. Manage.* **120** (4), 423–443.
- Storn, R. & Price, K. 1995 *Differential Evolution—A Simple and Efficient Adaptive Scheme for Global Optimization over Continuous Spaces*. Technical report, International Computer Science Institute, Berkeley, CA.
- Suribabu, C. R. & Neelakantan, T. R. 2006a Design of water distribution networks using particle swarm optimization. *J. Urban Water* **3** (2), 111–120.
- Suribabu, C. R. & Neelakantan, T. R. 2006b Particle swarm optimization compared to other heuristic search techniques for pipe sizing. *J. Environ. Informatics* **8** (1), 1–9.
- Vairavamoorthy, K. & Ali, M. 2000 Optimal design of water distribution systems using genetic algorithms. *Comput. Aided Civil Infrastruct. Eng.* **15** (2), 374–382.
- Vairavamoorthy, K. & Ali, M. 2005 Pipe index vector: a method to improve genetic-algorithm-based pipe optimization. *J. Hydraul. Eng.* **131** (12), 1117–1125.
- Varma, K. V., Narasimhan, S. & Bhallamudi, S. M. 1997 Optimal design of water distribution systems using an NLP method. *J. Environ. Eng.* **123** (4), 381–388.
- Vasan, A. & Raju, K. 2007 Application of differential evolution for irrigation planning: an Indian case study. *Water Res. Manage.* **21** (8), 1393–1407.
- Wu, Z. Y. & Simpson, A. R. 1996 *Messy genetic algorithms for optimization of water distribution systems*. Research report no. R140. The University of Adelaide, Adelaide.
- Wu, Z. Y., Boulos, P. F., Orr, C. H. & Ro, J. J. 2001 Using genetic algorithms to rehabilitate distribution systems. *J. AWWA* **93** (11), 74–85.
- Zecchin, A. C., Maier, H. C., Simpson, A. R., Leonard, M. & Nixon, J. B. 2007 Ant colony optimization applied to water distribution system design: comparative study of five algorithms. *J. Water Resour. Plann. Manage.* **133** (1), 87–92.

First received 27 February 2008; accepted in revised form 3 November 2008. Available online September 2009