

Development of a self-rechargeable digital water flow meter

Songhao Wang and Ronald Garcia

ABSTRACT

The objective of this paper is to present the feasibility of a self-rechargeable digital water flow meter (SRDFM) system for water pipes using the latest data processing and wireless communication technologies while causing negligible water pressure drop (head loss). The system uses a Pelton turbine generator to power the electronic circuit, which processes and transmits the signals generated by several flow meters. ZigBee technology was used to process and send wireless signals. Signals from two water meters were acquired, processed, and transmitted with only one control/transmission unit during this study. The new system was assessed experimentally, reaching a maximum of 80 m of wireless transmittance distance at a minimum flow rate of 5 L/min for a 16-mm diameter pipe (self-charged).

Key words | advanced meter infrastructure (AMI), automatic meter reading (AMR), data acquisition unit (DAQ), micro controller unit (MCU), pipe flow, self-rechargeable

Songhao Wang (corresponding author)
Ronald Garcia
Department of Mechanical Engineering,
Kun Shan University,
949 Da Wan Road,
Young Kang City,
Tainan, 710
Taiwan
E-mail: songhaow@hotmail.com

ABBREVIATIONS

AC	alternating current
AMR	automatic meter reading
API	application programming interfaces
Bps	bite per second
DC	direct current
GIO	general input and output
IC	integrated circuits
LC	inductor and capacitor
MCU	micro controller unit
SRDFM	self-rechargeable digital flow meter
WDN	water distribution network

INTRODUCTION

Water metering is a fundamental practice including improved public health protection, reduced pressure on water natural resources, and increased quality of distribution and therefore public perception of water suppliers (Thornton *et al.* 2002).

Knowing how much water is being lost or distributed properly enables water suppliers to manage the water distribution network (WDN) efficiently and effectively. Therefore, many new algorithms for water distribution are being developed and improved including NSGA-II (Artina *et al.* 2012) and the differential evolution (Suribabu 2010) to optimize the WDN. However, manual meter reading is still a common practice for collecting data in many WDN.

‘Manual meter reading can work reliably, but in many communities it encounters a number of difficulties that hamper its efficiency and cost-effectiveness’ (Thornton *et al.* 2002). Most of these difficulties arise from the fact that meters are physically located in difficult to reach places. Some meters are located on customer premises or on sidewalks which are sometimes obstructed. Also, manual meter reading is a labor-intensive job. These are the reasons why the use of an automatic method to perform this task is of great benefit.

Automatic meter reading (AMR) systems have been in existence since the 1970s, and it is the installation of a city-wide automated meter reading network which allows

utilities to perform some basic readout functions of a customer's meter (Craemer & Deconinck 2010) and the centralization of the data with the objective of reducing labor costs and automating data collection by the use of electronic devices.

With the increases in technological instrumentation, the use of energy increases as well. For water meters in an AMR network, the flow rate information is sent to a central station, in most cases wirelessly through ZigBee, Wi-Fi, SMS, or GPRS (Al-Omary *et al.* 2011). Batteries have been the most common way to power these devices, but due to the high demand of energy need to be replaced frequently. Another solution to this issue has been to use solar panels, which increase the cost of the system. The purpose of this study is to demonstrate that an AMR system could be self-rechargeable without incurring high costs or jeopardizing the system security, as well as presenting the advantages of centralizing the signal processing for reducing power consumption and system cost. Although the main idea presented in this paper could be applied to other areas of water management, such as pressure and leakage monitoring, the study of its feasibility is beyond the scope of this study.

The system consists of one custom-made generator, one central signal processing unit, one wireless communication module, and two self-made water meters (miniature generators).

The function of the generator was to provide power for the signal processing unit and the communication module while causing minimum pressure drop. Similar generators are available or under development, such as the axial flux generator (Hong *et al.* 2003). However, currently, the analysis of the efficiency of the generator is beyond the scope of the present work.

The role of the processing unit was to filter each water meter signal, as well as calculating their corresponding flow rate. One of the novelties of this system is that the water meters (miniature generators) were to generate sinusoidal waveform signals proportional to the speed of the turbine, so as to avoid the usage of any speed sensor and thus reducing the power consumption of the overall system. Only one ZigBee module was utilized to transmit the flow rate information of two flow meters to an external device for further usage, in this case a PC.

The presented infrastructure can be integrated into an advanced meter infrastructure (AMI) using commercial flow meters in order to comply with the standards for smart metering such as NTA8130 for water meters specifically.

SETUPS FOR THE EXPERIMENTAL SYSTEM

A 16-mm pipe testing bench was made for the experiment (Figure 1). In the system, first the water reservoir was located at ground level, immediately beside a pump (1) that pumped up the water through a pipeline of 0.5 m height. At this height, the first component installed was a generator (2) which was equipped with a control module. The pipe is then divided into two subdivisions, one flow meter was installed in each subdivision (3). Finally, the water went back to the original reservoir.

The signals from both water meters were acquired, processed, and transmitted by the control module (4 and 5). The

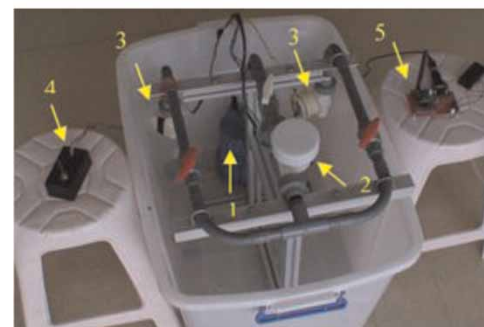
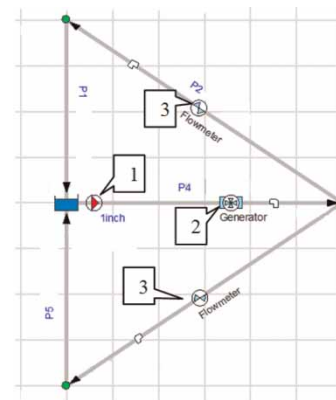

Figure 1 | Testing bench diagram.

transmitter was inserted into a permeable case to ensure the circuit did not have direct contact with the water.

The power generated by the system relies on the flow rate. An ideal and convenient water meter would be one that can acquire the signal, process it, and transmit or display the flow rate using no external power in an accurate and durable manner as well as being maintenance free (Wang *et al.* 2010a, b). The dynamic energy of the water flow was harvested using a small custom-made permanent magnet generator designed with twelve field windings and a seven-blade Pelton turbine. Previous studies emphasized the impeller parameters including the geometry and the number of blades (Wang *et al.* 2010a, b, 2011) (Figures 2 and 3). The generator used two stainless steel roller bearings for the impeller rotation to reduce friction and to maintain the minimal amount of parts in direct contact with the water.

For different pipe diameter and arrangements, pipe flow generators were studied and discussed (Wang & Tobias 2011).

The alternating current (AC) energy generated was converted to direct current (DC) power, stabilized, and



Figure 2 | The pipe flow generator in this study.

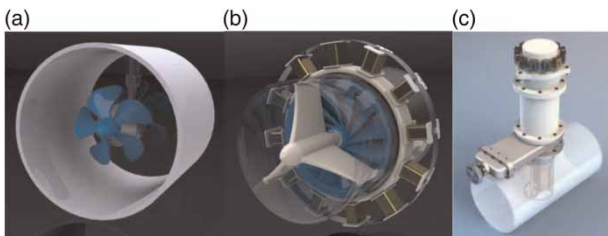

Figure 3 | Pipe flow generators for different pipe diameter and different arrangements (Wang & Tobias 2011). (a) Large pipe. (b) Medium pipe. (c) Vertical axis generator for non-stop flow assembly.

regulated to recharge the system's batteries. The energy stored in these batteries was used to power the control module and provide energy for the period of time when the flow rate became low, which is four hours during night time as shown in Figure 4.

It is worth mentioning that care was taken in the circuit not to overcharge the batteries as well as maintaining a constant load to the flow.

PRESSURE LOSS ESTIMATION

A major rationality of this system is the minimum pressure loss (head loss) it will cause to the pipe flow, thanks to modern electronics technology. The following is the quantitative estimation to verify the feasibility from the mechanical engineering point of view. Figure 5 presents the pressure loss in a circular pipe due to an extra device, which is the self-rechargeable digital water flow meter (SRDFM).

Therefore the pressure loss due to an extra device in the pipe flow can be expressed as:

$$\Delta P = W/Q \quad (1)$$

where ΔP is the pressure loss in Pa, W is the power in watts, and Q is the flowrate in m^3 per second.

Thanks to today's microelectronics technology, the energy consumption becomes smaller and smaller. In this study, the electronic circuit for sending the signal is 30 mA at 3.3 V or 0.1 W. However, in every one second of active mode, only 27 milliseconds are needed for sending 4 bytes of data, which contains enough information for the flow condition, and the communication protocol. That is to say, the total power average needed is 2×10^{-3} W during transmitting in that second. During sleeping mode, however, only 1×10^{-3} W is needed. Therefore, it is safe to assume the power consumption for the electronic system is 3×10^{-3} W.

$$\eta = \eta_1 * \eta_2^2 * \eta_3 = 0.45(45\%)$$

where $\eta_1 = 95\%$ is the efficiency for the Pelton turbine (Jošt *et al.* 2010); $\eta_2 = 98\%$ is the efficiency for ball bearing; $\eta_3 = 50\%$ is the efficiency for a permanent magnet generator.

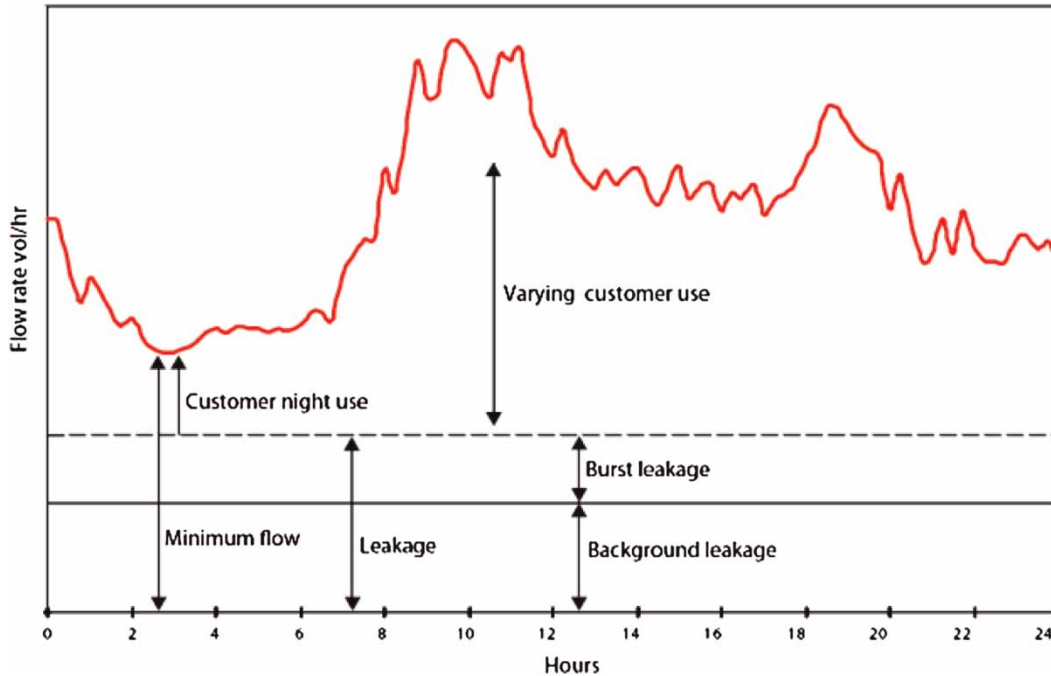
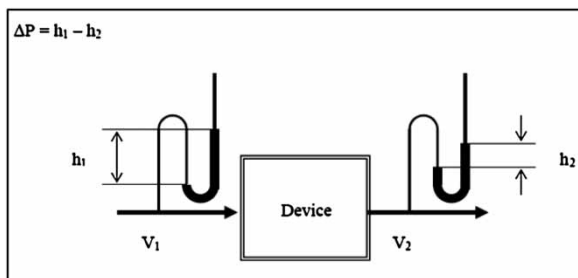

Figure 4 | Twenty-four hours' leakage modeling based on minimum night flow analysis (Thornton *et al.* 2002).



$$\text{Power} = \frac{\text{force}}{\text{area}} \times \frac{\text{distance} \times \text{area}}{\text{time}} = \Delta P Q$$

Figure 5 | Pressure drop in a circular pipe due to an extra device.

Therefore the total amount of power needed, including all possible losses through mechanical components would be 7×10^{-3} W.

Based on the above fluid mechanics formula, the theoretical pressure loss (fluid power) needed to produce this electric power is calculated and listed in Table 1. Where D is the diameter of the pipe in meters, A is the cross-sectional area of the pipe; V is the mean flow velocity; Q is the flow rate; W is the power required by the system to operate safely; ΔP is the pressure loss after extracting power (watts) from the flow and h is the equivalent head loss of water.

Table 1 | Fluid power needed to produce the power for electronics circuit

D mm	A mm	V m/s	Q m ³ /s	W mW	ΔP N/m ²	h mm H ₂ O
100	8	1	0.00785	3	0.38	0.04
16	0.2	1	0.00020	3	14.92	1.49

Notice from Table 1 that, in order to overcome the 7×10^{-3} W required for the system to work, theoretically a minimum of 3.5 mm of head would be lost.

Pressure loss due to pipe components and fittings

To provide more visual comparison, the equivalent head loss is compared with the minor loss from regular pipe components and fittings. The minor head loss of a regular pipe components and fittings can be expressed as:

$$h_{\text{minor_loss}} = \xi V^2 / 2g \tag{2}$$

where $h_{\text{minor_loss}}$ is the minor head loss (m); ξ is the empirical minor head loss coefficient; V is the mean velocity of the flow (m/s); g is gravity (m/s²).

The empirical minor head loss coefficients are listed and corresponding results for a union and an elbow are listed in Table 2.

Based on the above calculations and comparison between Table 1 and Table 2, some interesting observations are presented in Table 3. For pipe of medium size (0.1 m), the pressure loss needed to produce the consumed power for sending signals is approximately to 1/4 of a threaded union or 3/2 of a 90° elbow. At the same flow speed, for small pipes like the one used in this study (0.016 m), the pressure loss needed for sending signals is equivalent to about one threaded union or 1/5 of a 90° elbow. Therefore it is reasonable to say the pressure loss needed to send flow information is quite insignificant and the proposal of the SRDFM system is very attainable, thanks to the modern technology of microelectronics.

SIGNAL ACQUIRING AND PROCESSING

In order to know the flow rate at the pipes, each flow meter uses a small core, a small generator, causing minimum friction loss between the magnets and the coil. The voltage generated was between 0 and 0.5 V in a sinusoidal form

Table 2 | Coefficient on pressure loss from pipe fittings

Type of component or fitting	Minor loss coefficient (ζ)
Tee, flanged, line flow	0.2
Tee, threaded, line flow	0.9
Tee, flanged, branched flow	1.0
Tee, threaded, branch flow	2.0
Union, threaded	0.08
Elbow, flanged regular 90°	0.3

Table 3 | Pressure loss from pipe fittings

	ζ	V m/s	g m ² /s	h mm H ₂ O
Union, threaded	0.08	1	9.8	4.08
Elbow, 90°	0.3	1	9.8	15.31

(AC) and its frequency varies according to the speed of the turbine, thus avoiding the use of speed sensors and reducing power consumption.

That signal could not be used as it was; it had to be filtered out and transformed into a square waveform signal. Therefore, a second order low pass LC filter was applied to the analog signal before the MCU could process it through an analog comparator.

DATA PROCESSING

In order to process the signal coming from the analog comparator a CC2430 system on chip, specially tailored for IEEE 802.15.4 and ZigBee applications, was used. The ZigBee system provides many advantages over other kind of wireless transceivers such as variety of modules. Each vendor develops its own system with different power rate and transmittance range to meet customer needs, whereas ZigBee supports several network topologies to achieve long distance and reliable communication.

The following features were configured in this transceiver, as shown in Figure 6: a 24-bit sleep timer, two interrupts, serial communication and its RF transceiver. The sleep timer was configured to set a period between when the system enters into second sleep mode (interrupts enabled) and enters into active mode (running at 32 Mhz).

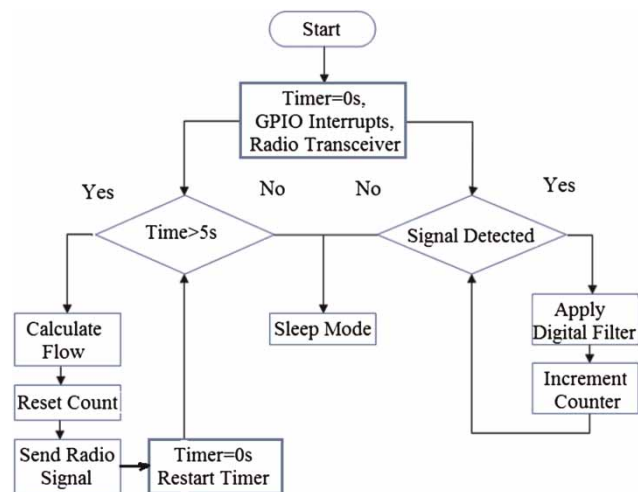

Figure 6 | Program flow chart.

The second sleep mode allows low power operation ($0.3 \mu\text{A}$). For sending the water meter information, a maximum of 27 ms was used. The time interval for sending the signal was preconfigured to be every 5 seconds. Therefore, every 5 seconds the system triggered a signal regardless of any other process taking place. That signal alerts the MCU to process any data captured during sleeping mode by the interrupt. The interrupt was configured to trigger a signal at the rising edge of every pulse, waking up the system, incrementing a counter, and going back to sleeping mode. The system average power consumption on active mode was 1.26 mA without data transmission.

The energy from the generator was then converted to DC power, stabilized, and then used to recharge four AAA nickel-cadmium batteries. The power of these batteries was then regulated with a low drop voltage regulator down to 3.3 VDC to power the whole system. [Figure 7](#) presents the schematic of the circuit to capture, convert, stabilize, store, and regulate the generated power.

The connectors x1-1 and x1-2 are the pins where the AC coming from the generator is plugged in. The transformer (TR1) is the high frequency transformer to isolate the circuit load and the generator. It was used since the circuit load can vary according to the work performed and battery charge. The bridge rectifier (B1) was used to convert from AC to DC. A fuse (TR5) was then installed to prevent any abnormality damaging the circuit with a high voltage. A large capacitor (C3) was used to filter and temporarily store the incoming energy and then finally to the battery as permanent storage.

For this circuit, there was no need to install a recharge manager since the maximum power generated was never enough to damage the batteries at any charging state. Finally, an ultra-low dropout voltage regulator was used to regulate the power, which then would be used by the ZigBee module. Note that the batteries were used as a big capacitor, which can hold energy for a period of time in case the flow is not enough to generate the demanded power.

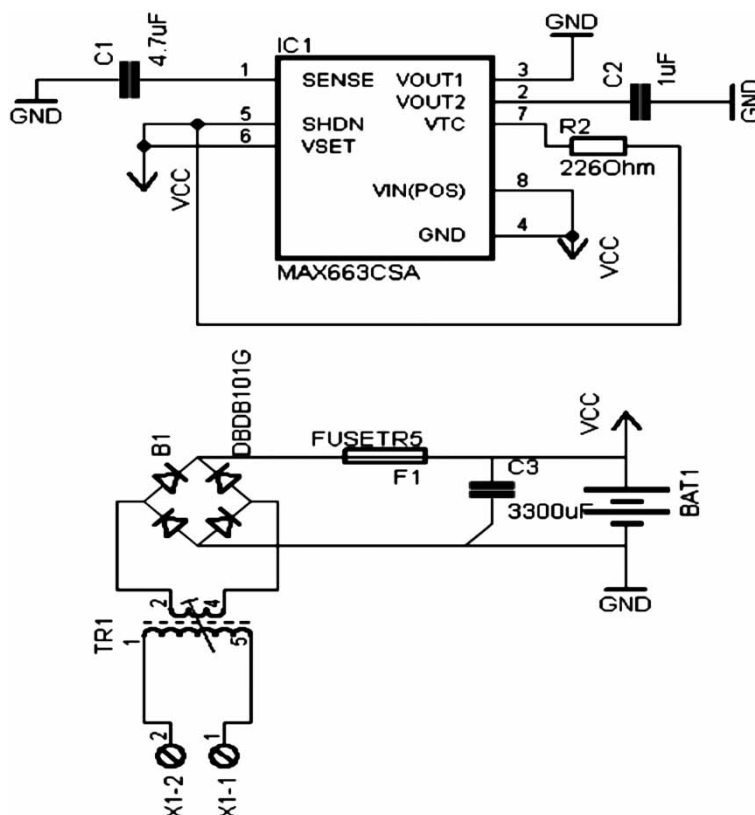

Figure 7 | Power capture and conversion.

Application	User
API	ZigBee Alliance ZStack
Security	
128-bits encryption	
Network	
Star-Mesh-Cluster tree	
MAC	IEEE Silicon
PHY	
868/915Mhz/2.4Ghz	

Figure 8 | ZigBee structure.

DATA TRANSMISSION

A ZigBee module was programmed to send the data. ZigBee is a short-distance, simple structured, low power and low transmission rate wireless communication technology based on IEEE 802.15.4–2003 standards. The structure of the ZigBee system is shown in Figure 8.

The data transmission was done at 1,200 bits per second, to guarantee a reliable transmission. Both water meters' data were sent sequentially, consuming approximately 30 mA during data transmission. For the receiver, the power consumption during data reception was 27 mA.

For simplicity, the network topology for this study had been set up as a peer-to-peer network. However, in more complex and larger networks, the system can be configured using the following supported topologies: star, clusters, and mesh (Herzog 2005) to expand its limited transmittance distance range.

For this study, two ZigBee application programming interfaces (API) were tested, SimpliciTI and ZStack. Although SimpliciTI was much more manageable to configure and program, only 30 m of transmittance distance could be achieved. ZStack, on the other hand, could reach up to 80 m. Therefore, it is clear that the efficiency achieved by ZStack was considerably higher than that of SimpliciTI, at least in this application.

RESULTS AND DISCUSSION

Accuracy

Most flow meters could potentially work, but they also might not work accurately. The ability of a flow meter to

make a measurement is called accuracy. In this work, the flow meter accuracy was expressed in percent or actual flow rate as in Equation (3) (Spitzer 1996):

$$\begin{aligned} \% \text{ of rate accuracy} = \\ \pm (\text{flow uncertainty} / \text{instantaneous flow rate}) \times 100 \quad (3) \end{aligned}$$

At a maximum flow rate, this percentage of accuracy was estimated to be $\pm 2.5\%$ since:

- Flow uncertainty was equal to 1.15 L.
- Instantaneous flow rate was equal to 45.5 L/min.

In general, the lower the friction loss a flow meter has, the more accurate it is. In this experiment, it was observed that as long as constant low friction loss is applied to the flow an accurate flow rate could be obtained as well, within limits.

Equation (4) was derived in order to convert the rotational frequency of the generator to flow rate. This was programmed in the micro controller and it was executed in real time. In the following formula x is the rotational speed of the rotor in Hz:

$$F(x) = \begin{cases} 0.27x + 8.52 & \text{If } x \geq 124 \\ 0.33x + 2.78 & \text{If } 30 \leq x < 124 \\ 0.45x - 1.65 & \text{If } x > 30 \end{cases} \quad (4)$$

As a comparison, Figure 9 presents the reading of flow rate in liters per minute from a commercial flow meter

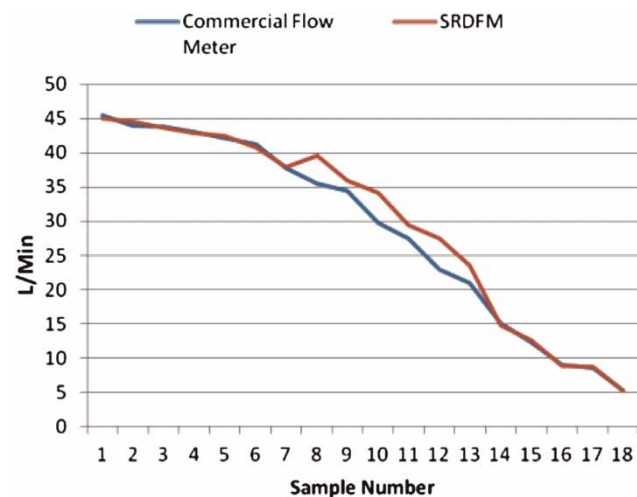

Figure 9 | Flow rate – Mini Wheel vs. SRDFM.

and the SRDFM. The accuracy is kept more constant at a flow rate from 5 to 20 L/min and from 37 to 45.5 L/min.

System power consumption

The batteries start charging when the voltage of the generator rises higher than 4.8 V. However, the system started working until the batteries were sufficiently charged. It was observed during the experiment that if the batteries were removed, the system started sending a wireless signal in a stable manner when the flow rate reaches 25 L/min. Therefore, from this flow rate and the above, the batteries started recharging.

Once the batteries have enough energy to handle data transmission, the system was able to measure flow rate at 5 L/min accurately.

Table 4 presents the actual power generated in the experiment at different flow rates. This information allows us to see how much energy we could extract from the dynamic energy of the water in cases where different transmission systems, like GPRS or Wi-Fi, are required.

Transmission range

The bandwidth used by the system was 2.4 GHz. The ZigBee system reached in this study was a maximum distance of 80 m outdoors and 30 m indoors. Due to reliability, the data transmission rate was configured at 1,200 bps. Figures 10 and 11 show the range available for communication between the transceivers indoors, as well as outdoors. The antenna was positioned at 0.5 m height above ground level. Both tests were carried out while varying the water flow rate, hence varying the energy generated produced no noticeable variation on available communication range.

Table 4 | Flow rate and power generation

Flow rate (L/min)	Volts-DC (V)	Amps-DC (mA)	Watts-DC (W)
5	2.5	7	0.02
10	5.3	25	0.13
20	10	44	0.44
30	16	68	1.09
40	20	100	2.00
45	21	115	2.39

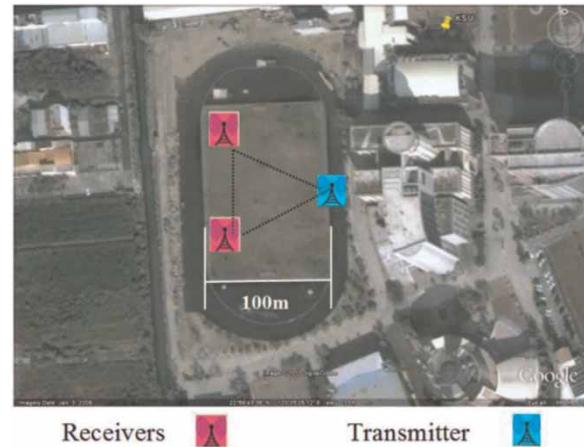

Figure 10 | Outdoor stable transmittance range obtained (in K.S.U. campus, 82 m).

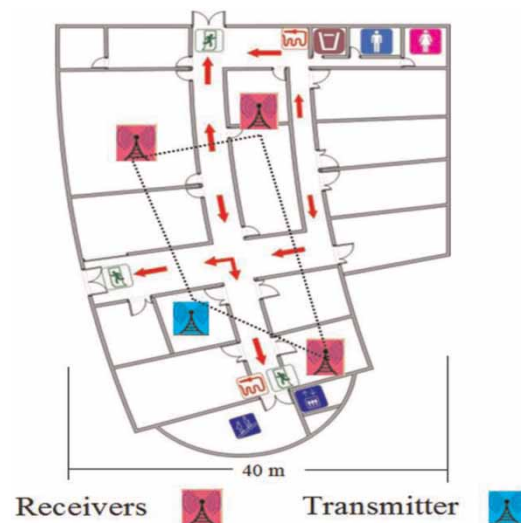

Figure 11 | Indoor stable transmittance range obtained (in K.S.U campus, 30 m).

CONCLUSIONS AND OUTLOOKS

As power consumption of ICs and signal transmission become lower and lower, the possibilities of avoiding external power supplies on flow meters are becoming more and more attainable.

Design, analysis, and successful experiments were performed in this study for the proposed SRDFM system. The following points are an assessment of the achievements of this research:

- Only one control/transmission unit is used as control module to acquire, process, and transmit signals from

multiple water meters. It is worth mentioning that the data from each flow meter are sent through wires to the transmission unit so as to utilize more the resources of the ZigBee module and reduce power consumption during transmission.

- Data acquisition: Signals were acquired and processed at a high speed using low power consumption techniques.
- Data processing: The sine waveform of a low power AC signal could be converted and amplified to a DC square waveform. No hall sensor or any other sensor was used to acquire the rotational speed of the generator. A low flow rate, as low as 5 L/min, was accurately measured.
- Data transmission: Data were successfully transmitted over 80 m outdoors and 30 m indoors, wirelessly. Such transmission was reliable.
- Pressure drop: Theoretical head loss due to the integration of an extra device in the network pipe was calculated and found to be within reasonable limits according to the system power requirements. Further study would determine the real pressure drop within different types of generators.

Therefore, the proposed system is capable of communicating its data through a wireless network with energy generated by itself. This is the ideal case scenario for any AMR. This system can be adopted by any utility with different budgets. It can be integrated into a complete AMR system in which man power is not needed to collect the data. It can also be used in a simpler system where an operator only needs to go within the transceiver's available communication range to obtain the data using a hand-held device. Moreover, the system causes no major impact of pressure drop in the main lines.

ACKNOWLEDGEMENTS

Part of the project was supported by Taiwan National Science Council under contract #97-2221-E-168-034. The authors are very grateful for the funding.

REFERENCES

- Al-Omary, A., El-Medany, W. & Al-Irhayim, S. 2011 Design and implementation of secure low cost AMR system using GPRS technology. *International Conference on Telecommunication Technology and Applications*. Proc. of CSIT vol.5, IACSIT Press, Singapore, p. 138.
- Artina, S., Bragalli, C., Erbacci, G., Marchi, A. & Rivi, M. 2012 Contribution of parallel NSGA-II in optimal design of water distribution networks. *J. Hydroinformat* **14** (2), 310.
- Craemer, K. D. & Deconinck, G. 2010 *Analysis of State-of-the-Art Smart Metering Communication Standards*. ESAT-ELECTA, Electrical Energy Computer Architectures, Leuven, p. 1.
- Herzog, C. 2005 *Creating Value with ZigBee Networks*. Industrial Embedded Systems Resource Guide, USA, 31.
- Hong, G., Holmes, A. S., Heaton, M. E. & Pullen, K. R. 2003 Design, fabrication and characterization of an axial-flow turbine for flow sensing. *Transducers, Solid-state Sensors, Actuators and Microsystems 12th International Conference*, Boston, MA, USA, 8–12 June.
- Jošt, D., Mežnar, P. & Lipej, A. 2010 Numerical prediction of Pelton turbine efficiency, 25th IAHR Symposium on Hydraulic Machinery and Systems, Timișoara, Romania. IOP Publishing, IOP Conf. Series: Earth and Environmental Science **12** (2010) 012080, p. 3.
- Spitzer, D. W. 1996 *Flow Measurement: Practical Guide for Measurement and Control*, 2nd edition. The Instrumentation, System, and Automation Society, Research Triangle Park, NC, ISBN 1-55617-334-2, p. 67.
- Suribabu, C. R. 2010 Differential evolution algorithm for optimal design of water distribution networks. *J. Hydroinformat* **12** (1), 66–82.
- Thornton, J., Sturm, R. & Kunkel, G. 2002 *Water Loss Control Manual*, 2nd edition. McGraw-Hill Professional, New York, pp. 202–204.
- Wang, S. & Tobias, E. 2011 Development of a vertical axis pipe flow generator with swing gates. *Appl. Mech. Mater.* **157–158**, 1541–1544.
- Wang, S., Garcia, R., He, H. & Chen, J. 2010a Development of a self-powered pipe flow metering system. *15th Flow Measurement Conference (FLOMEKO)*, October 13–15, Taipei, Taiwan, p. 1.
- Wang, S., Porres, C. F. H., Zuo, M. & Xiao, W. 2010b Study of impeller design for pipe flow generator with CFD and RP. *Conference Proceedings of American Institute of Physics, AIP*, (<http://www.aip.org/>), ISSN 0094-243X, 1225, pp. 265–275.
- Wang, S., Perez, R., Doblado, J., Garcia, R. & Chen, J. 2011 Development of pipe flow generators. *Adv. Mater. Res.* **233–235**, 2432–2438.

First received 21 May 2012; accepted in revised form 14 January 2013. Available online 14 February 2013