

Simulation of Soil Frost Depth and Effect on Runoff

Paper presented at the Nordic Hydrological Conference
(Rovaniemi, Finland, August - 1988)

Bertel Vehviläinen

Water and Environment Res. Inst., Helsinki, Finland

Yuri Motovilov

Water Problems Inst., USSR Academy of Sciences, Moscow

A physically based soil frost depth model usable with air temperature data and precipitation data, is presented. Snow depth is calculated from precipitation data using a physical snow cover model. The soil frost depth model is tested in one small basin, with a five-year calibration and verification period. Results from snow depth and soil frost depth simulation were satisfactory also in the verification period.

In the second stage simulated frost depth information was used to develop an HBV-runoff model version, attempting to simulate the possible effect of soil frost on runoff. The simulation results are presented. These results suggest that soil frost does not have a very important effect on runoff in this forested basin.

Research Area

The research area of Tujuoja is a small experimental basin near the western coast of Finland in the area of the Kalajoki basin, 64° N, 25° E. The area comprises 20.6 km², of which 82 % is forest (canopy density 30 %), 12 % field, 4 % bog and 2 % urban area. There are no lakes in the area, and the mean slope is 2.3 %. According to Mustonen (1965), the distribution of soil types is: graded soils 24 % (of which coarse sand 14 %), moraines 17 % (of which coarse sand 10 %) and peat soils 59 % (28 % of which is 30-49 cm deep).

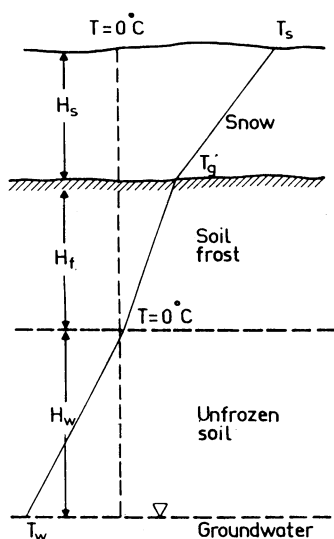

Fig. 1. Schematic soil section and temperature distribution.

Soil Frost Model

Fig. 1 presents the winter situation in a schematic soil section during frost formation with snow cover. Snow cover and soil form a three layer system, through which the heat flux from the snow surface is calculated using the basic heat conduction equation

$$q \equiv -k \frac{dT}{dz} \quad (1)$$

where

- q - heat flux through a layer dz
- k - thermal conductivity of the layer dz
- T - temperature
- z - depth

If we assume that all freezable moisture in the zone of negative temperature in soil turns to ice during soil freezing, and that phase transitions occur only at the freezing or thawing front, we can separate layers of frozen and unfrozen soil. Several frozen layers can form during repeated air temperature fluctuations where temperatures temporarily rise above zero degrees centigrade in the beginning of winter before the permanent snow cover is formed. When meltwater enters a frozen layer it remains unfrozen, since we have assumed that phase transitions occur only at the freezing or thawing front.

The accuracy of the computation of heat and mass transfer, and thus of soil frost depth, depends largely on the accuracy with which the physical characteristics of the soil and snow cover (thermal conductivity, moisture content, specific heat, etc.)

Simulation of Soil Frost Depth and Effect on Runoff

are assigned. There is very little information on these characteristics for various soils in larger areas, and what is available refers mainly to soils with a disturbed structure. Therefore, simple formulas are frequently as accurate as more complex relations obtained on the assumption that soil properties are constant according to depth. This assumption may introduce greater errors than any other assumption.

With the foregoing in mind, we develop one of the simplest formulas for calculation of soil frost depth, in which the inflow of heat from below (groundwater surface) is disregarded and the distribution of temperature in the frozen layer and snow cover is assumed to be linear.

Under the assumption of linear temperature distribution in soil and snow, Eq. (1) is used to calculate heat flux through the snow cover (q_1), frozen soil (q_2) and unfrozen soil (q_3)

$$q_1 = -k_1 \frac{T_g - T_s}{H_s} \quad (2)$$

$$q_2 = -k_2 \frac{T_f - T_g}{H_f} \quad (3)$$

$$q_3 = -k_3 \frac{T_w - T_f}{H_w} \quad (4)$$

where

k_1, k_2, k_3 – thermal conductivity of snow, frozen soil and unfrozen ground

T_s – snow surface temperature

T_g – ground surface temperature

T_f – temperature at the bottom of frozen soil layer ($T_f = 0^\circ \text{C}$)

T_w – temperature at the groundwater surface

H_s – snow cover depth

H_f – soil frost depth

H_w – depth of the layer of unfrozen ground above the groundwater level

If we assume that there is no latent heat loss in the border between the snow and the ground, then

$$q_1 = q_2 \quad (5)$$

Furthermore the temperature at the border between frozen and unfrozen soil is zero: $T_f = 0^\circ \text{C}$. Making these assumptions we get the following equation for the temperature of the soil surface T_g

$$T_g = T_s \frac{H_f}{H_f + k_2 / k_1 H_s} \quad (6)$$

In the border between the frozen and unfrozen soil layer, as the depth of frozen

soil increases and while the water in the soil is freezing, the latent heat loss is calculated according to the following equation

$$q_2 \equiv q_3 = Q \frac{dH_f}{dt} \tag{7}$$

where

- Q - $L (w - w_1)$
- L - the latent heat of fusion of ice
- w - soil moisture in volumetric units (m^3/m^3)
- w_1 - unfrozen water in frozen soil (m^3/m^3)
- t - time

The amount of unfrozen water in frozen soil is a function of soil temperature, but in frost depth calculations it can be kept constant, about $0.05-0.10 m^3/m^3$. Assuming that the heat flux over the unfrozen soil layer q_3 is small compared to latent heat exchange in the freezing border, we can simplify Eq. (7) by assuming that $q_3 = 0$. Then by solving Eq.(7) with the help of Eq. (6), we get the following function for increase in the depth of frozen soil H_f

$$H_f = -S + ((S + H_f)^2 - 2 k_2 T_s \frac{dt}{Q})^{0.5} \tag{8}$$

$$S = \frac{k_2}{k_1} H_s$$

It is more difficult to compute the movements of the upper boundaries of frozen layers during soil thawing than to compute the movement of freezing boundaries, since the redistribution of moisture supplied from the surface is more intense during thawing, and phase transitions may play a much greater role in a frozen layer. As a result, virtually impermeable layers, so-called “blocking layers” (Kalyuzhnyy *et al.* 1977), may form. As mentioned by several researchers and particularly by Kaluzhnyy *et al.* (1977), the formation of blocking layers is atypical of the forest soils in the northern part of the European USSR (the soil and vegetation type being similar to those in our research area) because of their high permeability.

Therefore we disregarded phase transitions in the frozen layer, *i.e.* virtually excluded the possibility of the formation of blocking layers.

To compute the rate of soil thawing, we use the same approach as for soil freezing. We assume that the temperature of the meltwater penetrating into the soil is equal to zero, and that the cold content of the soil is negligibly small. We also assume that all the water is in liquid state at a soil temperature above zero.

With allowance for these assumptions and also for deriving relation Eq. (6), we obtain an expression for computing the movement of the thawing boundary H_m

$$H_m = (H_m^2 + 2 k_3 T_g \frac{dt}{Q})^{0.5} \tag{9}$$

Simulation of Soil Frost Depth and Effect on Runoff

It is obvious that the frozen layers may combine or disappear during freezing and thawing. In that case the number of layers decreases.

Thermal Conductivities

Eqs. (8) and (9) are the basic equations for calculating frost and thaw depth in soil. The thermal conductivity of frozen soil is higher than the thermal conductivity of unfrozen soil of the same moisture content, because the conductivity of ice is about four times the conductivity of water. The thermal conductivity of frozen soil is taken as 1.3 times that of unfrozen soil (Kuchment *et al.* 1983)

$$k_2 = 1.3 k_3 \quad (10)$$

The thermal conductivity of unfrozen soil is a function of soil moisture and soil type. In this study the following equation is used (Kuchment *et al.* 1983)

$$k_3 = a \log w_p + b \quad (11)$$

where

w_p – soil moisture as percentage of weight = 100 w/D

D – volume density of soil, value 1.2 is used

a – parameter, value 0.00085 J/s cm °C is used

b – parameter, value -0.000023 J/s cm °C is used

The thermal conductivity of snow is a function of the density, temperature and microstructure of snow. Functions for the thermal conductivity of snow usually include snow density as the only independent variable. Here we use the function given by Abels (1892)

$$k_1 = c D_s^2 \quad (12)$$

where

c – parameter of value 0.0284 J cm⁵/s °C g²

D_s – snow density g/cm³

Connection of the Frost Depth Model to the HBV-Model

The frost model is constructed on the basis of Eqs. (8) and (9) so that it is capable of simulating several layers of frozen and unfrozen soil following cold and warm periods. This frost/thaw depth model is then combined with a modified version of the HBV-3 (Bergström 1976) Fig. 2. In the simulation of frost/thaw depth, the connection with the HBV-model occurs through the soil moisture model by using the soil moisture storage MVS as the amount of water, which is available for the frost formation in the upper active soil layer. The depth of the active soil layer is 67 cm based on calibration against observed frost depth values. The volumetric soil moisture w is calculated now using equation.

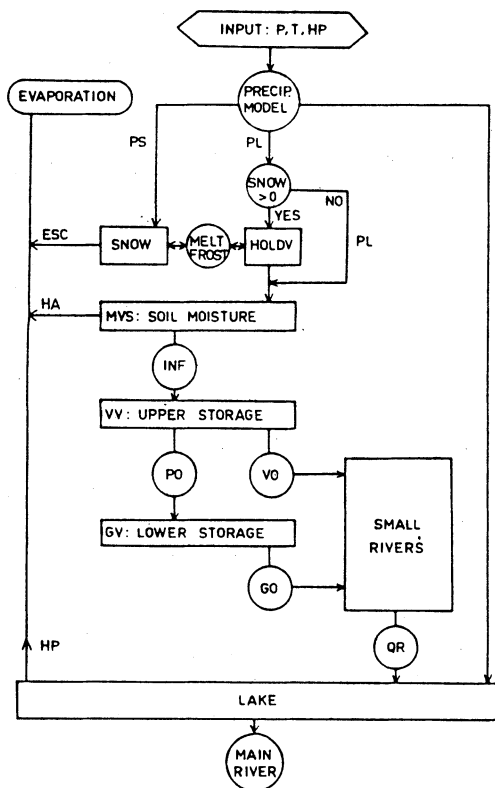

Fig. 2. The structure of the modified HBV-3 model.

$$w \equiv \frac{MVS}{H_a} \tag{13}$$

where

MVS = soil moisture storage in the HBV-model in centimeters of water
 H_a = depth of the active soil layer containing soil moisture storage; value of 67 cm used in the Tujuoja basin

Snow Cover Model

The accumulation and ablation of snow cover is simulated in this case using a physically based snow cover model (Motovilov and Vehviläinen 1987). This model simulates snow melt by the energy balance model. Potential melting and freezing of snow and precipitation are then used as input for a physically based snow cover model which simulates the density, depth, water retention and water yield from snowpack. Density and depth are essential values for simulating the thermal conductivity of snow (Eq. (12)) and the depth of frozen and unfrozen soil (Eqs. (8) and (9)).

Results of Frost Depth Simulation

The period of 1976-1981 was used for the calibration of frost depth and other components of the runoff model, the period of 1970-1975 for the verification. The criterion used in estimating the performance of the simulation model for snow cover, frost depth and the whole runoff model against runoff was R^2 (Nash and Sutcliffe 1979)

$$R^2 = \frac{F_0^2 - F^2}{F_0^2} \tag{14}$$

$$F_0^2 = (X_{t,obs} - X_{mean,obs})^2 = \text{variance}$$

$$F^2 = (X_{t,obs} - X_{t,sim})^2$$

The performance criteria and the number of observations (N) during both periods were:

variable	calibration		verification	
	R^2	N	R^2	N
water equivalent	0.922	38	0.684	43
snow density	0.505	38	0.463	43
snow depth	0.831	38	0.553	43
soil frost depth	0.121	17	0.156	12

The performance criteria do not reveal much about the goodness of fit between different sub-models, because its value depends on the variance: F_0^2 . With large variance (as for water equivalent) the results based on R^2 are better than with smaller variance (density). But it can be used to evaluate the consistency of the model between calibration and verification periods. In regard to the water equivalent model performance dropped from 0.922 to 0.684; this reveals some over-calibration. The model performance of the frost depth model is 0.121 in the calibration period and 0.156 in the verification period. The frost depth model is thus at least consistent, but could it simulate the frost depth properly? The accuracy of the frost depth model can be judged partly by visual inspection from Fig. 3, presenting simulation results for frost and snow depth in the verification period. During the calibration period, the largest errors occurred in the simulations for the winter of 1978-1979 and for the winter of 1979-1980. The errors were connected to the simulation of snow cover formation and heat conduction through the snow cover in the beginning of the winter. If the start of the snow cover period is not simulated correctly, great errors will occur in frost depth simulation.

In the verification period (Fig. 3.) the performance criteria were higher, indicating good model consistency, but the value, 0.156, is rather low, partly because of

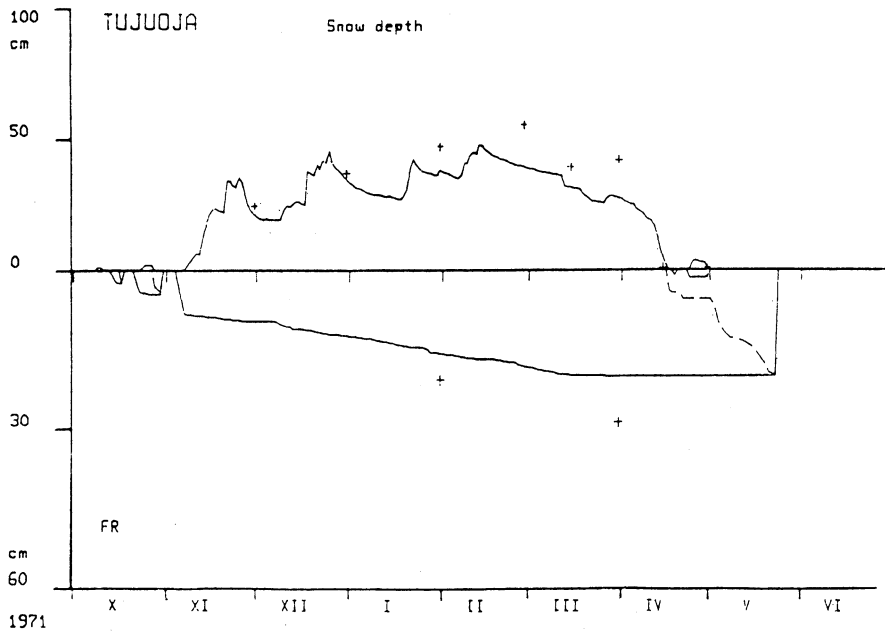
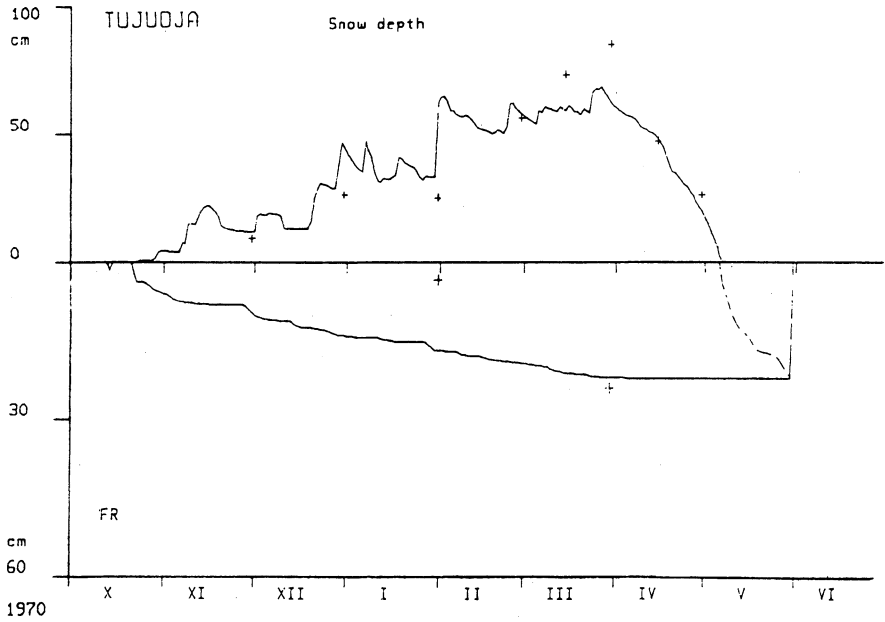

Fig. 3. The simulation of frost depth and snow depth in the basin of Tujuoja during the verification period (1970-1976). The observations are marked (+). Frost depth is indicated by the solid line and the depth of thawed soil by dotted line.

Simulation of Soil Frost Depth and Effect on Runoff

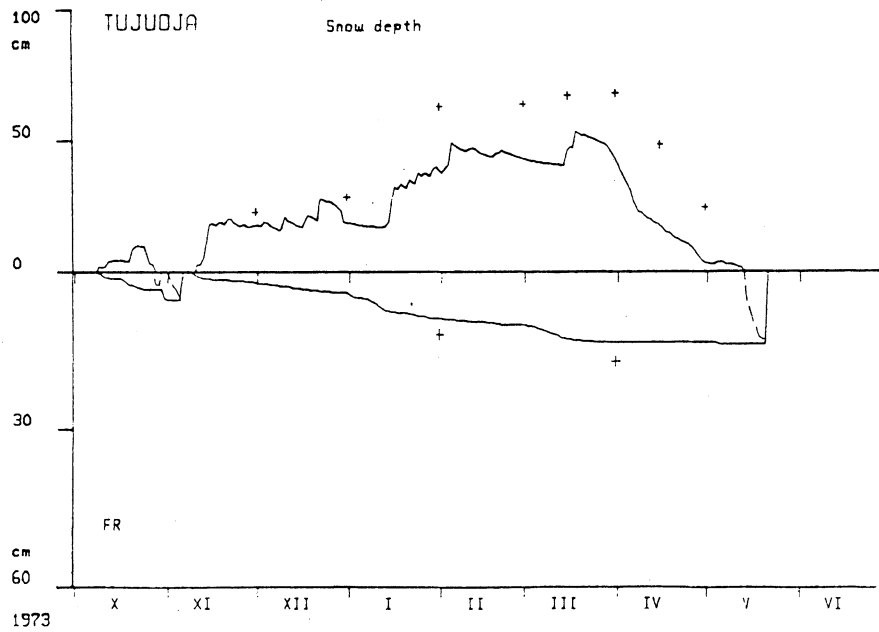
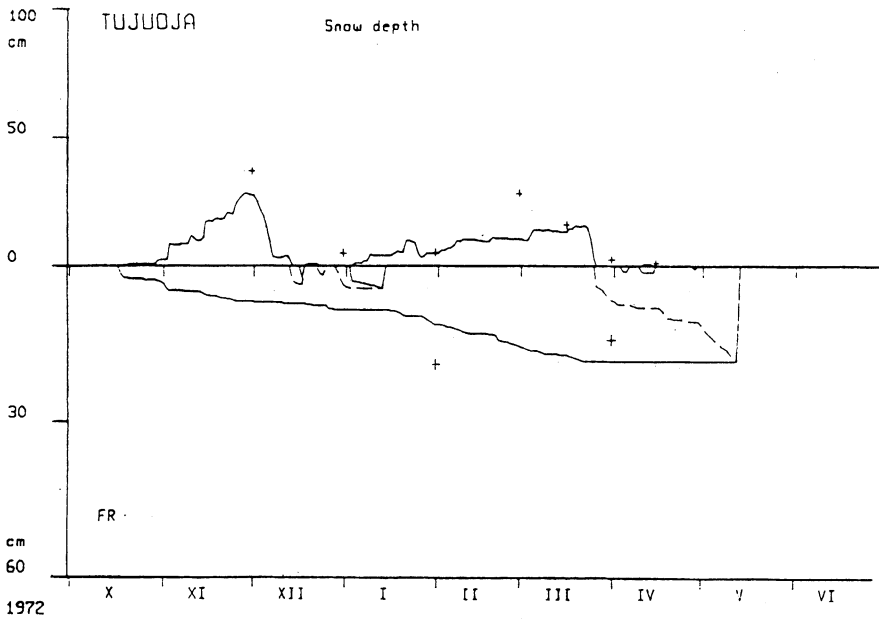

Fig. 3. continued

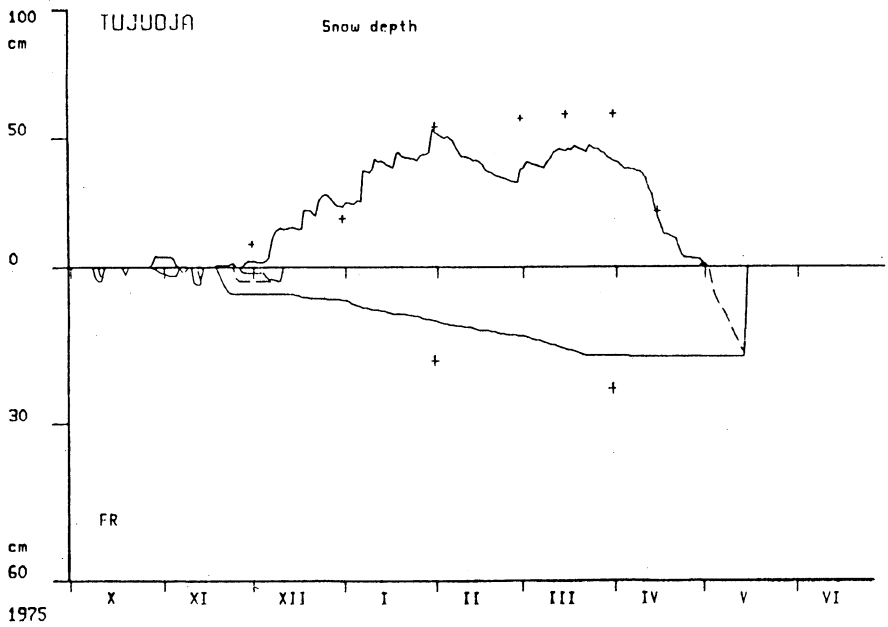
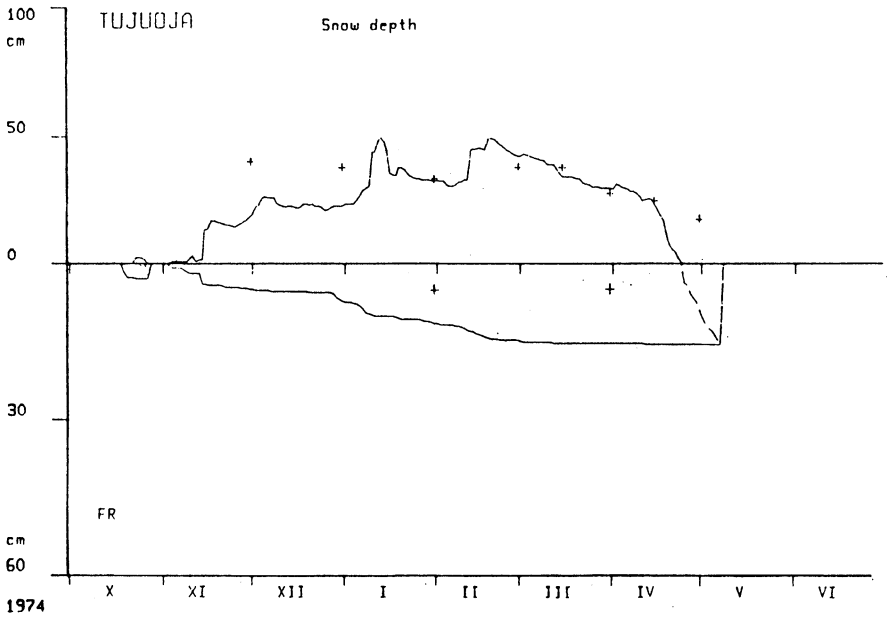

Fig. 3. continued

Simulation of Soil Frost Depth and Effect on Runoff

the low variance of depth measurements and, of course, due to errors. In the winter of 1974-1975, the reason for the error in frost depth simulation is the same as in the calibration period: the error occurred in the simulation of frost depth just at the beginning of the winter and snow cover period. The error during the first measurements for the winter of 1970-1971 could be due to measurement error, because the simulated and measured frost depths were equal during the later measurement, and the snow depth simulation was correct between the measurements. In January 1970 there were two warm periods with considerable snow melt. Some of the meltwater came through to the river. In this period the frost depth may have diminished.

The calibration and verification period revealed the importance of correct simulation of the beginning of the snow cover accumulation. This is clear: without a snow cover the frost depth increases quickly, in the absence of the effective insulator *i.e.* new low density snow.

Although some simulation errors occurred in the modelling of the calibration and verification period, the overall simulation capability of the frost depth model was satisfactory during this ten-year period. The frost depth model is quite simple, needing only daily precipitation data and air temperature data (snow depth and density are simulated), and so can be run with operational watershed models if desired.

Simulation of the Effect of Soil Frost on Runoff

In forested moraine areas the effect of soil frost is considered to be small (Kuusisto 1984, Schwarz 1984). In the Tujuoja basin 41 % of the area is moraines and graded soils comprising 40 % gravel and sand and only 1 % of silt and clay. Thus it is obvious that below the predominately thin peat soils (59 % of the area: 28 % 30-49 cm, 18 % 50-99 cm and 13 % over 100 cm thick), the underlying soil is also mostly gravel and sand. So 70-80 % of the area of the Tujuoja basin can be considered to be moraines or graded soils. More than half of the real bog area is drained and thus quite dry so that impermeable ice layers do not form due to the freezing of water on the surface at the beginning of the winter. The Tujuoja basin is most probably an area which has good infiltration capacity also in the frozen state.

In view of the facts presented above, we could not expect any dramatic improvements in the model performance by taking into account the effect that frozen ground might have on runoff.

Sand and Kane (1986) tested a modified HBV-3 model where parameters of soil moisture routine were varied seasonally in winter and summer periods according to the different hydraulic properties between frozen and unfrozen soils. The test area was the Chena River basin in Alaska (5,125 km²). In this test, the varying parameters were maximum soil moisture storage (MVAK), empirical coefficient e in a

function which simulates the water yield (*INF*) from soil moisture storage and the limit for potential evaporation (*ALP*); see also Fig. 2

$$\begin{aligned}
 INF &= YIELD(MVS/MVAK)^e & (15) \\
 HA &= HP \cdot MVS/ALP, \quad \text{if } MVS < ALP \\
 HA &= HP, \quad \text{if } MVS > ALP
 \end{aligned}$$

where

- INF* - water yield from soil moisture storage to upper storage (mm/d)
- YIELD* - water yield from snowpack and rainfall into soil moisture storage (mm/d)
- MVAK* - maximum soil moisture storage (480 mm)
- e* - exponent Eq. (15)
- HA* - actual evaporation (mm/d)
- ALP* - soil moisture storage value after which the actual evaporation equals the potential evaporation (411 mm)

In the Chena River basin the parameters *MVAK*, *e* and *ALP* all differ considerably from the frozen soil period to the unfrozen soil period.

In the Tujuoja basin, we tested the possible effect of soil frost on parameters of the soil moisture model and of the model part below it; formation of runoff through upper and lower storages (Fig. 2). For the soil model, the parameters in function Eq. (15), which determine the water yield from soil storage (*MVS*), were modified according to soil frost as follows in order to determine the empirical dependence between runoff and soil frost usable in the HBV-model

$$MVAK = MVAK + C1_f ICE \quad (16)$$

$$e = e + C2_f ICE \quad (17)$$

$$ALP = ALP + C1_f ICE \quad (18)$$

$$ICE = \text{frozen water in soil (mm), abt. 20-100 mm} \quad (19)$$

Eq. (16) is intended to show the decrease in the maximum water storage capacity of soil with increasing soil frost, *i.e.* we suppose that constant *C1_f* is negative or zero if there is no effect. Accordingly, the threshold value of soil moisture storage for potential evaporation also decreases (Eq. 18) if the maximum soil moisture storage decreases. Eq. (17) is intended to show greater values of parameter *e* with frost, making the water yield from soil moisture storage more peaked (*C1_f* is thought to be positive if soil frost has an effect on runoff formation).

Furthermore, the equations which calculate outflow (*VO*) from upper storage (*VV*) and percolation (*PO*) to lower storage as well as outflow (*SO*) into soil moisture storage from temporary storage (*SV*) were modified. The basic functions were

$$VO = VC \cdot VV \quad (20)$$

Simulation of Soil Frost Depth and Effect on Runoff

$$PO = PC VV \quad (21)$$

$$SO = SC SV \quad (22)$$

$$SO = SO + (SV - SVM) , \text{ if } SV > SVM$$

where

- VV – upper storage (Fig. 2.) (mm)
- SV – temporary storage (mm) over the soil surface (and over MVS -storage in runoff model) due to water stored in and between snow drifts during snow melt. SV -storage is not presented in Fig. 2.
- VO, PO, SO – outflows (mm/d)
- VC, PC, SC – parameters: 0.38, 0.001, 0.06 (1/d)
- SVM – maximum value of temporary storage (55 mm)

The modifications were made by changing the parameter values according to the amount of frozen water (mm) in the soil by means of the following equations

$$VC = VC + C3_f ICE \quad (23)$$

$$PC = PC + C4_f ICE \quad (24)$$

$$SC = SC + C5_f ICE \quad (25)$$

$$SVM = SVM + C6_f ICE \quad (26)$$

It is assumed in Eqs. (23)-(26) that soil frost increases runoff, and thus increases the outflow from different storages by increasing the storage runoff coefficients (VC, PC, SC) or by decreasing storage (SVM).

The calibration of this modified model was made during the period 1976-1981. The best values for the parameters reflecting the possible effect of frozen soil on runoff obtained from the calibration, were (Eqs. (16)-(17) and (23)-(26))

$C1_f = 0.00001$	$C3_f = 0.000001$	$C5_f = 0.0$
$C2_f = 0.145$	$C4_f = 0.00009$	$C6_f = 0.0$

As the parameter values indicate, the only case where soil frost had an effect on the model parameters was in function Eq. (15) according to which the water yield from soil moisture storage is simulated. The effect of frost on parameter e is quite large: with 60 mm of frozen water in the soil, the value of parameter e increases from 15 to 24; yet the effect on the water yield from soil moisture storage is only 2-3 mm/d at best (Eq. (15)). Fig. 4 depicts the simulation of the water yield from soil moisture storage with the modified model for the case where soil frost is simulated and for the case without soil frost simulation in winter (*i.e.* all soil water is assumed to be liquid; and the parameter e stays at the summertime value of 15). As seen from Fig. 4, soil frost has a minimal effect. This is obvious also if we examine the runoff curves; few differences would be corrected by assuming that soil frost increases

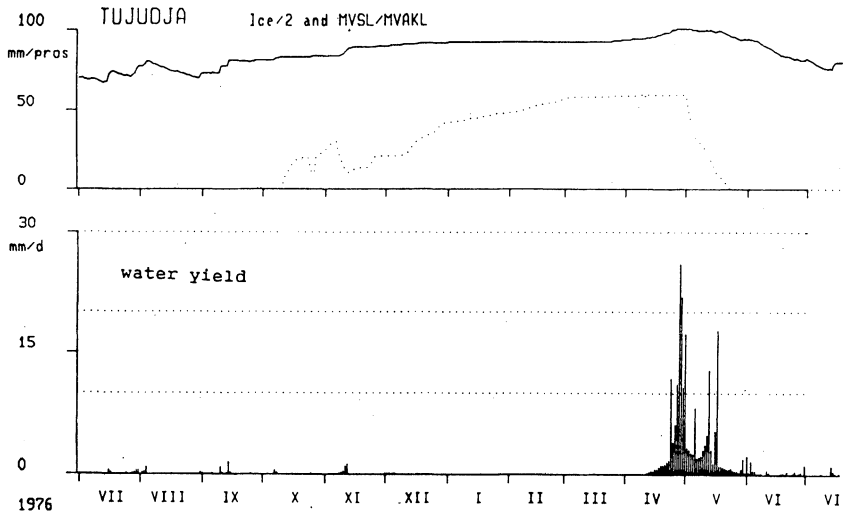

Fig. 4.a. Simulation of water yield (mm/d) from soil moisture storage using the modified soil moisture model (Eq. 18) included: $C2_f \equiv 0.145$ and simulation of frozen water ($2 \cdot \text{mm}$) in soil (...).

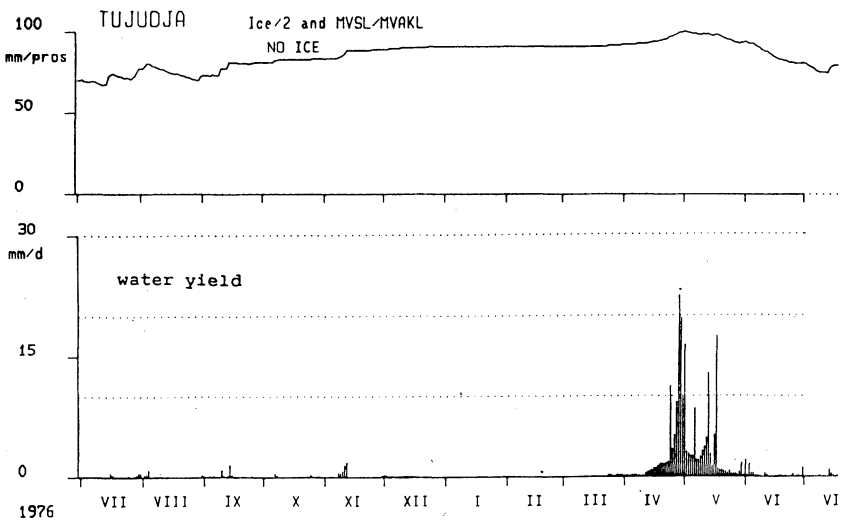

Fig. 4.b. Simulation of water yield from soil moisture storage without soil frost effect: all soil water is in liquid state and the value of parameter e is 15 (unfrozen soil value).

runoff at the beginning of spring runoff, e.g. in 1976 (Fig. 5) and the situation is similar also for the other years in the calibration period.

As compared to the unmodified model the modified model did not improve model performance during the verification period (1970-1976). The performance criteria R^2 against observed runoff were:

Simulation of Soil Frost Depth and Effect on Runoff

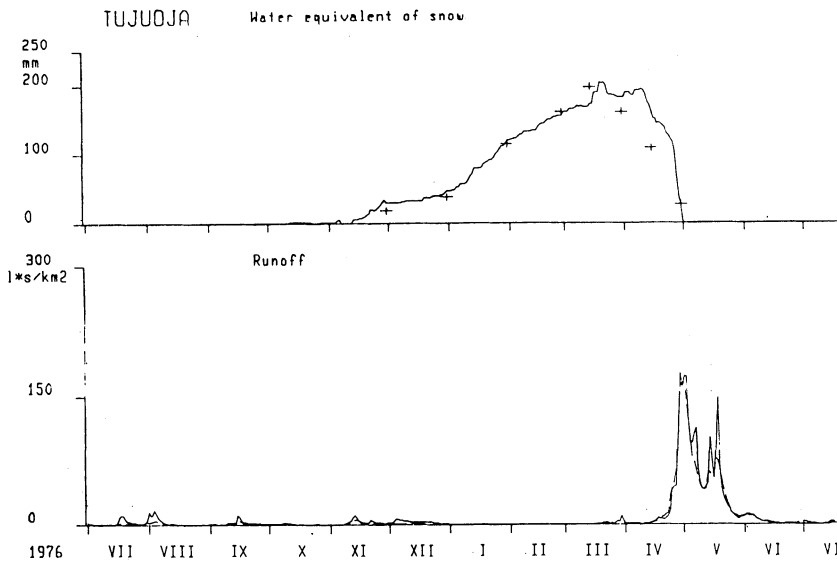

Fig. 5.a. Simulation of runoff using the modified model where the effect of soil frost is taken into account in Eq. (18), the areal water equivalent is also simulated. The observed runoff is indicated by the solid line and the observed areal water equivalent is marked (+).

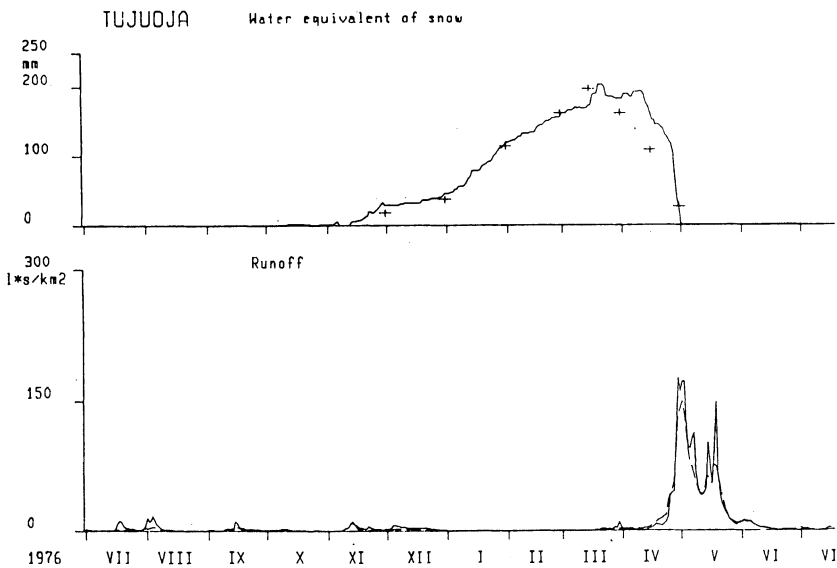

Fig. 5.b. Simulation of runoff without the effect of frozen soil.

Model	Calibration	Verification
Unmodified	0.856	0.635
Modified	0.857	0.629

Thus the assumption (Kuusisto 1984; Schwarz 1984) that soil frost does not considerably affect runoff in forested areas seems to be correct also according to the results of this study.

References

- Abels, H. (1892) Beobachtungen der täglichen Periode der Temperatur im Schnee und Bestimmung des Wärmeleitungsvermögens des Schnees als Function seiner Dichtigkeit. Rep. Meteorol.
- Bergström, S. (1976) Development and application of a conceptual runoff model for Scandinavian catchments, SMHI, Nr RHO 7, Norrköping.
- Kalyuzhnyy, I.L. *et al.* (1977) The role of Hydrophysical Soil Properties in the Formation of Spring Flood Runoff Losses. Trans. State Hydrologic Institute (Trudy GGI), No. 233, pp. 127-136.
- Kuchment, L.S., Demidov, V.N., and Motovilov, Yu. G. (1983) Formirovanie Rechnogo Stoka (River runoff formation – physically based models). Nauka, Moskva.
- Kuusisto, E. (1984) Snow accumulation and snowmelt in Finland. Publications of Water Research Institute no. 55, Helsinki.
- Motovilov, Yu., and Vehviläinen, B. (1987) Snow cover and snowmelt runoff model in the forest zone. Proceedings of the International Soviet-Finnish Symposium in Water Research in Moscow, 1986. VYH (National Board of Waters and the Environment) monistesarja Nro 27, Helsinki.
- Mustonen, S. (1965) Hydrological investigations by the board of Agriculture during the years 1957 to 1964. Soil and hydrological investigations No. 11, Helsinki.
- Nash, J.E., and Sutcliffe, J.V. (1970) River flow forecasting through conceptual models. Part I – a discussion of principles, *Journal of Hydrology*, Vol. 10 (3).
- Sand, K., and Kane, D.L. (1986) Effects of seasonally frozen ground in snowmelt modeling. Proceedings of the symposium: Cold Regions Hydrology. University of Alaska-Fairbanks, Fairbanks, Alaska. Edited by D.L. Kane, AWRA.
- Schwarz, O. (1984) Schneeschmelze und Hochwasser Ergebnisse eines forstlichen Schneemessdienstes im Schwarzwald. Schnee-hydrologische Forschung in Mitteleuropa, editor Brechtel, H.-M. Deutscher Verband für Wasserwirtschaft und Kulturbau, Heft 7.

Received: 7 December, 1988

Address:

Bertel Vehviläinen,
Hydrological Office,
Water and Environment Research Institute,
National Board of Waters and the Environment,
PB 250, SF-00101 Helsinki, Finland.

Yuri Motovilov,
Water Problems Institute,
USSR Academy of Sciences,
Moscow,
USSR.