

Object tracking: Absence of long-range spatial interference supports resource theories

Alex O. Holcombe

School of Psychology, University of Sydney, Australia



W.-Y. Chen

School of Psychology, University of Sydney, Australia



Piers D. L. Howe

Psychological Sciences, University of Melbourne,
Australia



Attentional tracking of a moving target can be impaired by the presence of a second object, particularly if the second object is another target. One potential cause of this impairment is spatial interference. But the impairment may alternatively reflect a need to divide a finite attentional resource among targets. The performance cost of splitting a resource among targets should not be affected by the targets' proximity and should persist even at very large target separations. In contrast, spatial interference should impair performance more when the second object is near than when it is far. Here, we report six experiments that assess the effect of the separation between two targets. Within the crowding zone for target identification found by previous psychophysical literature, tracking performance improved with separation. Beyond the crowding zone, there was no evidence that increases in separation improved two-target performance, suggesting no long-range spatial interference. Unexpectedly, in the one-target condition, greater separation from other distractors reduced performance somewhat. This may reflect a configural tracking process. For the two-target condition, due to the absence of a separation effect beyond the crowding zone, at the largest separations performance at tracking two targets remained much poorer than performance tracking one target. This large additional-target cost is better explained by hemisphere-specific resource theories than by spatial interference.

their children move in and out of the water. The ability to maintain attention on the positions of moving objects is typically studied using the multiple-object tracking (MOT) task (Pylyshyn & Storm, 1988; Scholl, 2009). In this task, a number of identical objects are presented and a target subset to be tracked is briefly cued. The cues then disappear, so that the targets are identical to the nontargets, and all objects move about the screen for several seconds. At the end of the trial, all the objects stop moving, and observers must indicate which objects were the targets. With commonly used display parameters, most people can track four or five targets but do poorly with more (Pylyshyn & Storm, 1988; Yantis, 1992; Alvarez & Cavanagh, 2005).

Some theorists have suggested that the limits on this tracking ability are the same as those on attentional selection generally (Cavanagh & Alvarez, 2005), or that the limits constrain attentional selection by preceding it (Pylyshyn, 1989; Pylyshyn, 2003). The limits on tracking may, therefore, have implications for attentional selection generally. In a recent paper, Franconeri, Alvarez, and Cavanagh (2013a) suggested that the type of process that limits tracking also constrains visual short-term memory and several other cognitive abilities. Specifically, they proposed that object competition for limited cortical territory sparks spatial interference and is the root cause of the capacity limit in each case. In the case of visual attention, competition for cortical territory was predicted to manifest as spatial interference among tracked targets (Franconeri, Lin, Pylyshyn, Fisher, & Enns, 2008; Franconeri, Jonathan, & Scimeca, 2010; Franconeri, 2013; Franconeri et al., 2013a; Franconeri, Alvarez, & Cavanagh, 2013b).

Introduction

On the road, drivers monitor the movements of others' vehicles. In sports, players track the positions of their opponents. At the beach, parents keep watch as

Citation: Holcombe, A. O., Chen, W.-Y., & Howe, P. D. L. (2014). Object tracking: Absence of long-range spatial interference supports resource theories. *Journal of Vision*, 14(6):1, 1–21, <http://www.journalofvision.org/content/14/6/1>, doi:10.1167/14.6.1.

Resource theories and spatial interference theories

For the purposes of this article, we distinguish between resource theories and spatial interference theories. According to resource theories, tracking is constrained by the limited availability of some process or analyzers in the brain. Typically this refers to a limitation that is not specific to restricted regions of a visual hemifield, and we will follow that usage here.

One early theory posited a set of four or five pointers dedicated to attentional selection and tracking (Pylyshyn & Storm, 1988). More recent theorists have sometimes favored a continuously divisible neural resource that is divided among the targets (Alvarez & Franconeri, 2007). This resource might be a neural population in parietal cortex (Howe, Horowitz, Wolfe, & Livingstone, 2009), such that the fewer neurons allocated to a target, the poorer the performance in tracking that target. Another resource-type theory is that only a single target is actually processed at any one time, and in the case of multiple targets, the tracking focus must switch serially among them (Pylyshyn & Storm, 1988; Tripathy, Ogmen, & Narasimhan, 2011; Holcombe & Chen, 2013). This would help explain certain findings of dual-task interference such as between tracking and auditory discrimination (Allen, McGeorge, Pearson, & Milne, 2004, 2006; Alvarez, Horowitz, Arsenio, DiMase, & Wolfe, 2005; Tombu & Seiffert, 2008). Because tracking is largely independent in the left and right hemifields (Alvarez & Cavanagh, 2005; Chen, Howe, & Holcombe, 2013), two such resources must be posited, one in each cerebral hemisphere. For present purposes, a critical aspect of these theories is that the resource is hemifield-wide, as opposed to different bits of the resource processing different regions of the hemifield.

Rather than being imposed by a finite resource, the capacity limit on tracking might instead be caused by distance-dependent inhibitory interactions among object representations (Franconeri et al., 2008; Franconeri et al., 2013a, 2013b). According to this theory, tracking is mediated by neurons with local receptive fields and if not for spatial interference, participants would be able to track an unlimited number of objects (Franconeri et al., 2008; Franconeri et al., 2010; Franconeri, 2013). In particular, Franconeri et al. (2010) suggested that “tracked targets should inhibit each other if they are within a critical distance” (p. 2).

While Franconeri et al. (2008, 2013a, 2013b) proposed that spatial interference is the *sole* cause of tracking’s capacity limit, spatial interference and a resource might both exist and both constrain tracking. There is already strong evidence of short-range interference among tracked targets (Shim, Alvarez, & Jiang, 2008; Tombu & Seiffert, 2008). The outstanding

empirical issues, then, are the range of spatial interference and whether there is any nonspatial constraint on tracking. Keep in mind that here we refer to any nonspatial capacity limit on tracking as reflecting a resource, whether that resource is a single spotlight for tracking in each hemifield or a finite population of neurons in each hemisphere that must be divided among the targets.

Crowding

Crowding is a well-documented spatial interference phenomenon (Levi, 2008; Pelli & Tillman, 2008) that is likely to affect object tracking, as it affects an observer’s ability to select or individuate an object (Intriligator & Cavanagh, 2001). In the literature, crowding is typically used to refer to the spatial limits on a very particular task—identifying a single target in the presence of nearby stimuli. For such single-target identification tasks, the spatial range of crowding is rather well understood. Interference is absent or very small when objects are separated by more than half their eccentricity (Bouma, 1970). This is known as Bouma’s Law, although it may not apply in the fovea, and systematic departures from it occur in the periphery (which are minor relative to the range of separations used here; Gurnsey, Roddy, & Chanab, 2011), so it should be considered more a heuristic than a law. As yet there have been no investigations of whether the range of spatial interference in tracking is the same as that of crowding. But some evidence suggests that attentional facilitation or interference may extend over a longer range than that documented in the crowding literature.

Results suggesting long-range interference

In crowding paradigms, the participant attempts to identify one stimulus in the presence of irrelevant flankers, with the target stimulus typically in a prespecified location. Such experiments indicate that spatial interference does not extend far beyond half the target’s eccentricity (Bouma’s Law). However, tasks more complex than identification of a single target in a prespecified location have shown evidence of interference beyond the crowding range. Such findings raise the prospect of interference well beyond the Bouma crowding zone in MOT.

Bahcall and Kowler (1999) studied identification of two targets in two prespecified locations, which differs from crowding tasks that typically only involve a single target. Performance improved with separation, and that trend did not stop at the edge of the expected crowding zone, but rather separation continued to facilitate performance for distances up to nearly twice

the stimuli's eccentricity. This suggests the presence of long-range spatial interference (for related but more mixed evidence, see Cutzu & Tsotsos, 2003). Results of a modified visual search task developed by Franconeri, Alvarez, and Enns (2007) also suggested an interference gradient even for large separations. Participants were asked to detect the presence of a single vertical line in a large array of lines, where pre-cues indicated a variable number of locations that the target might appear in (Franconeri et al., 2007). Performance was poorer when more locations were indicated and when the arrays were dense rather than sparse. In one of the experiments, an inter-item spacing of 90% of eccentricity was compared to a spacing of 52% of eccentricity (approximately at the limit of the crowding zone expected from Bouma's Law). Performance was markedly better in some cases for the 90% of eccentricity spacing condition, suggesting there may be a long-range effect.

These experiments thus provide tentative evidence for long-range interference for visual search through multiple locations and for a dual-target identification task. Tracking may behave differently, of course, as tracking does not require target identification or the shifts of attention thought to be involved in visual search.

Physiology and brain imaging have also yielded some evidence for long-range spatial interference, but this has varied depending on what was measured. Hopf et al. (2006) used magneto-encephalography (MEG) to study surround suppression in human brains. Participants searched for a red target among blue distractors. On some trials, an irrelevant white ring was flashed at a variable distance from the target. This ring elicited a large neural response when it was far from the target. The response was smaller, however, when the ring was around the adjacent distractor, indicating surround suppression. The suppression appeared to be confined to the adjacent item, which was only 20% of the stimulus eccentricity away. The suppression they documented is thus consistent with interference being restricted to the Bouma range.

Suppression over longer ranges has been documented via neurophysiological recordings from the frontal eye field and from area lateral intraparietal area (LOP). In a study by Schall et al. (2004), monkeys performed a visual search task, and the response of frontal eye field neurons to distractors was smaller when the target was nearby than when it was further away. This suppression could extend to distances up to 80% of the eccentricity. A study of area LIP documented interference spanning even larger separations. In the associated experiments (Falkner, Krishna, & Goldberg, 2010), a saccade target was presented for 500 ms. The monkey was cued to saccade to it by offset of the fixation point, but 50 ms prior, a stimulus was flashed in the center of the cell's receptive field. Relative to a condition without a

saccade target, the response to the flashed stimulus was reduced, even when the saccade target was very far away, with statistically significant impairment at separations up to 40 deg. The retinal eccentricities involved were not explicitly reported but appears to have been 20 deg or less. The authors suggested that these cells and the frontal eye field (FEF) cells were involved in saccade planning and/or salience, wherein saccade and attentional targets are prioritized based on a global salience computation. On this interpretation, these interactions might not impair maintenance of attentional selection or tracking.

Franconeri et al. (2013b) suggested a different interpretation. They theorized that long-range suppression like that in the study of Falkner et al. (2010) causes interference during attentional tracking of multiple targets. A difficulty for this proposal is that Falkner et al. (2010) reported that nearly as often as not, the peak suppressive effect was not in the same hemifield as the receptive field center. But the cost of additional targets in attentional tracking is largely independent in the two hemifields (Alvarez & Cavonagh, 2005; Chen et al., 2013), suggesting that LIP suppression is not the main factor. However, Franconeri et al. (2013a, 2013b) may nonetheless be correct that long-range surround suppression in some other brain area(s) causes the capacity limit on tracking.

Previous findings regarding the range of interference

To assess the role of spatial interference in tracking's additional-target cost, we varied both the number of targets and the separation between objects. Several previous tracking papers already manipulated separation and found better performance for larger separations. In some of these, however, the objects could travel anywhere on the screen, with separation manipulated by enforcing a minimum value that unfortunately was not scaled with eccentricity (e.g., Shim et al., 2008; Tombu & Seiffert, 2008; Bae & Flombaum, 2012). In one study the separations on the screen were more carefully controlled, but fixation was unfortunately not required, so that the targets' eccentricity may have varied widely (Feria, 2013). For both types of studies, when the targets were at high eccentricities the minimum separation used would have been within the crowding range, whereas at low eccentricities they were not. As a result, one cannot know whether the effect of separation is attributable to separations outside the crowding range.

For understanding the range of interference, a more suitable study was conducted by Tombu and Seiffert (2011). They controlled both the eccentricity of a target and the distance of the nearest distractor. The objects were kept near an eccentricity of 8 deg, and target-

distractor separation was varied, although only within 4 deg, the Bouma crowding range. Performance improved with separation, suggesting that crowding by distractors does interfere with target tracking.

Franconeri et al. (2010) used a less direct approach. Their statistical analyses linked poorer tracking performance to trials where smaller separations happened to occur by chance. The results were mixed, however, and because they were based on aggregate correlations rather than experimental manipulation of individual separations, the separation range responsible for the possible improvement in performance is not clear.

Separation was directly manipulated and eccentricity carefully controlled by Carlson, Alvarez, and Cavanagh (2007). In the comparison most relevant here, at an eccentricity of 7 deg, the minimum edge-to-edge separation of the targets was either 2.5 or 7 deg. Tracking performance was higher for the larger separation. This could have been caused by long-range interference, but alternatively by interference confined to the crowding range. Consider that the 2.5 deg separation is likely within the crowding range, whereas the 7 deg separation is outside it.

Using an approach that we extended here, Holcombe and Chen (2012) presented a display with two concentric trajectories (each trajectory included one target and one distractor) and measured the maximum speed observers can successfully track one or two targets. The inner trajectory had a radius of 2 deg, while the outer trajectory had a radius of either 4 or 9 deg, yielding separations of 2 and 7 deg, respectively. Tracking performance was approximately the same for the two separations, leading Holcombe and Chen (2012) to conclude that spatial interference does not afflict tracking beyond the Bouma crowding range. But this did not convince Franconeri et al. (2013a, 2013b). Specifically, Franconeri et al. (2013b) appealed to the Falkner et al. (2010) LIP single-cell recordings and wrote that “levels of surround suppression are strong at both distances, and thus no difference in performance is expected” for the Holcombe and Chen (2012) separations. As mentioned in the previous section, the suppression documented in LIP was equally strong across-hemifield as within-hemifield, so it doesn’t seem it can play much of a role in tracking. Nevertheless, the idea that very long-range hemifield-specific suppression might occur somewhere in the brain is intriguing and worthy of testing.

The present experiments

To determine the role of spatial interference in the additional-target cost, we here manipulated separation between two targets while controlling eccentricity. We tested a much wider range of separations than have



Experiment	Eccentricity (deg)	Separation (deg)								
		1	2	3	5	7	9	18	21	59
	1			✓	✓	✓	✓			
	2	✓	✓			✓				
	3	✓	✓							
	4				✓	✓	✓			
	5							✓		
	6								✓	✓

Table 1. Separations tested for each experiment are indicated by checkmarks, and the corresponding stimulus eccentricities are indicated in the second column. Crowding should occur for the conditions indicated in red (Bouma’s Law). The curved dashed line connecting the trajectories of Experiments 1 through 3 is a reminder that the two trajectories were always isoeccentric in these experiments, whereas in Experiment 4 they were always at a fixed distance from the vertical midline (see Figures 1 through 3). The small dot in each icon represents the fixation point (not to scale).

previously been investigated and used a variety of configurations to assess the generality of the findings. By including both a one-target and a two-target condition, we assessed whether spatial interference is worse between targets than between distractors. The theory that tracking is impaired by suppression surrounding a target predicts that spatial interference will be worse in the two-target condition (Franconeri et al., 2008, 2010).

To quantify the performance cost of an additional target, we exploited an effect of speed. As object speed increases, tracking capacity declines until only a single target can be tracked (Alvarez & Franconeri, 2007; Holcombe & Chen, 2012). We compared the speed threshold for tracking two targets to that for tracking one target, for different spatial separations. This avoids the floor and ceiling effects that can plague percent correct when it is used as a dependent variable. Speed threshold will here refer to the speed at which tracking performance equals a particular criterion level, usually 80% correct, for the task of choosing the target rather than the distractor at the end of the trial.

The display configurations and associated separations are schematized in Table 1. Experiments 1 through 4 used pairs of discs sharing circular trajectories (see icons in Table 1). The separation between the two pairs’ trajectories was varied across trials. In two-target trials, one disc in each of the two trajectories was designated as a target. In one-target trials, a disc was

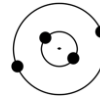
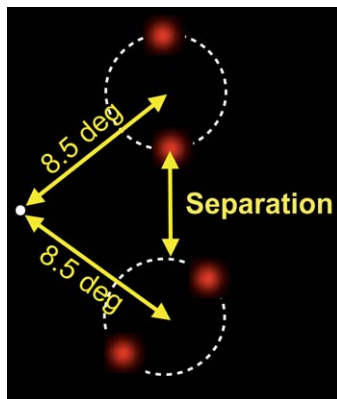

Figure 1. Display of Experiments 1 and 2. Two pairs of blobs were presented, vertically offset within a hemifield. A blob from one or both pairs was designated as targets. Each circular trajectory (radius 2.5 deg) was confined to one quadrant. The separation between the two trajectories varied. In Experiment 1, 3, 5, 7, or 9 deg separated them. In Experiment 2, the separation was 1, 2, or 7 deg. The eccentricity of the center of each circular trajectory was always 8.5 deg.

designated as a target in only one trajectory. Experiments 5 and 6 used concentric circular trajectories centered on fixation. Here, the targets were widely separated from each other and from distracters.

In Table 1, the red checkmarks indicate the conditions where Bouma's Law suggests crowding should occur. The details of the display used in Experiment 1 and Experiment 2 are schematized in Figure 1. Two pairs of blobs were presented, at various separations from each other. A blob from one or both pairs were designated as targets.

Experiment 1 primarily tested separations outside the crowding zone and found no long-range spatial interference. Experiment 2 used smaller separations to confirm that crowding (short-range interference) impairs tracking. Experiment 3 replicated this finding and also probed for a within-quadrant deficit (Carlson et al., 2007) by varying whether the targets were presented in the same quadrant or different quadrants. No within-quadrant deficit was found—possibly because the stimuli we used were different than those of Carlson et al. (2007).

In Experiments 1 and 2, separation was confounded with proximity to the vertical midline. This was addressed in Experiment 3 for small separations, and in Experiment 4 for larger separations, with no qualitative difference in results. The conditions with the larger separations (Experiments 4 and 1) yielded no evidence for long-range interference. To address the possibility of an extremely shallow interference gradient (Francorneri et al., 2013b), Experiments 5 and 6 tested much larger separations, using concentric trajectories.

Speed thresholds for tracking one target were substantially faster than thresholds for tracking two

targets, even at the largest intertarget separations. This finding supports resource theory and argues against long-range interference. Outside the crowding zone, there was no sign that increases in separation improved two-target performance, suggesting no long-range spatial interference.

Methods

All displays and experiments were controlled by a MacBook Pro running Python programs within PsychoPy (Peirce, 2007; van Rossum & Drake, 2001). The programs are posted at <https://opencscienceframework.org/project/t4vmy/>.

Participants

All participants reported normal or corrected-to-normal vision. Experiments 1 and 2 had eight participants each and Experiment 3 had 10 participants. Six of these participants were tested in all three of these experiments, including two authors. Experiments 1, 2, and 3 had four, three, and four female participants, respectively. Four participants (one female, two authors) were tested in Experiment 4. All participants reported normal or corrected-to-normal vision. Experiment 5 tested seven participants (one female), and Experiment 6 tested eight participants (four female). The protocol was approved by the ethics committee of the University of Sydney in accordance with the Declaration of Helsinki (pre-2013 version; the late 2013 version's statement that "Every research study involving human subjects must be registered in a publicly accessible database before recruitment of the first subject" appeared after this research was completed). Experiment 6 used a very short viewing distance and prospective participants were told if they experienced eyestrain when fixating that close, they should not continue. For that reason, two people did not continue after the practice trials. All participants were asked to do the experiment without their spectacles because the close viewing distance meant that the largest-eccentricity trajectory fell outside the frame of typical spectacles and there was a strong prospect of the frames blocking visibility of at least some of the objects for some of their trajectory. Those three who regularly wear contact lenses kept them on.

All the participants had extensive experience fixating in laboratory experiments. All but three had their eyes tracked in at least one earlier experiment in the lab, six of them in previous tracking experiments where they demonstrated their ability to maintain fixation (Holcombe & Chen, 2012; Chen et al., 2013; Lo &

Holcombe, 2013). To confirm that the eyetracker was not critical to those previous results, we re-analyzed the data of those previous tracking experiments that included eyetracking: experiment 2 of Chen et al. (2013) and experiment 2 of Holcombe and Chen (2012). We compared the performance for those trials rejected by the eyetracker to those not rejected by the eyetracker. The pattern of results (rank ordering of the conditions) was the same. Here, our main goal was to assess the effect of varying the separation between the objects, which eye movements would not affect.

Apparatus

Stimuli were displayed on a 21-in. SONY Multiscan G520 CRT monitor (1024 × 768 resolution; Sony Corporation, Tokyo, Japan) with a refresh rate of 120 Hz (for Experiments 1 through 4) or 160 Hz (for Experiments 5 and 6). Viewing distance was 57 cm for Experiments 1 through 4, 33 cm for Experiment 5, and 10–12 cm for Experiment 6 in a dimly lit room, with a chin rest and forehead support to avoid subject head movement.

Stimulus

Four red blobs were presented, evoked by the red gun only, CIE $x = 0.61$, $y = 0.34$, peak luminance 18.7 cd/m² with Gaussian intensity profiles yielding a visible diameter subtending approximately 1 degree of visual angle (deg). A white fixation point (diameter 0.1 deg; luminance: 167 cd/m²) was presented against a black screen (41 deg × 31 deg, luminance: <1 cd/m²) were displayed in Experiments 1 through 4. Icons in Table 1 represent the spatial arrangement of the objects in each experiment. The details are shown in Figures 1 through 4.

In Experiments 1 through 4, two pairs of blobs were presented in all conditions, always in the same visual hemifield. On half of the trials the two pairs were in the left hemifield and on the other half in the right hemifield. Both objects of each pair were on a circular trajectory centered in one of the four quadrants of the visual field. The radius of each trajectory was 2.5 deg and because the two blobs on a trajectory were always diametrically opposed, the separation between them was always 5 deg. In Experiments 1 through 3, the eccentricity of the centers of the trajectories was always 8.5 deg and the separation between targets was manipulated by varying across trials the centers of the circular trajectories. See Table 1 for the separations (distances between the trajectories) used in each experiment.

For Experiment 3, the trajectories were presented in the left hemifield in half of trials, and in the right hemifield in the remaining trials. Also varied was

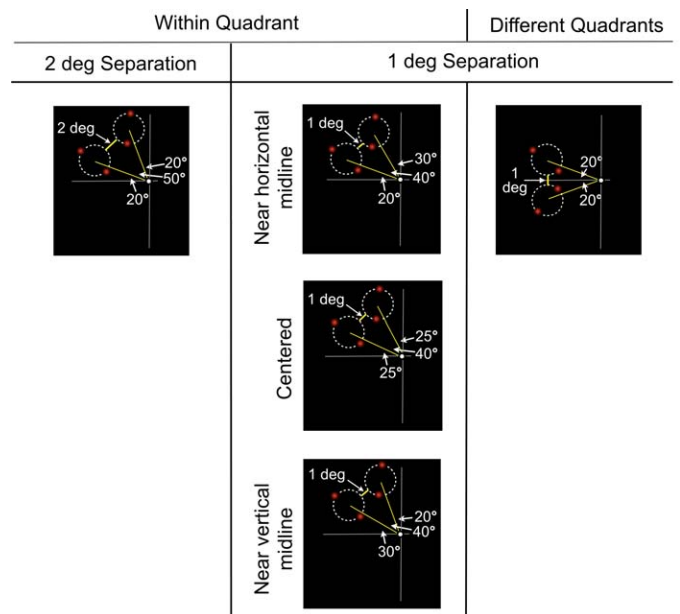

Figure 2. In Experiment 3, two pairs of blobs were presented on circular trajectories (with radii 2.5 deg) centered on 8.5 deg eccentricity. In one condition, the trajectories were separated by 2 deg. In four other conditions, the trajectories were separated by 1 deg. These conditions were termed near horizontal midline, centered, near vertical midline, and different quadrants. A blob from one or both pairs was designated as targets.

whether the two pairs were positioned within a single quadrant or placed in different quadrants (see Figure 2). In the 2 deg separation condition, they were always presented within a single quadrant, but for the 1 deg separation, sometimes they were in distinct quadrants. This tested for the within-quadrant deficit reported by Carlson et al. (2007).

In Experiment 4, rather than positioning the centers of the trajectories at the same eccentricity in all conditions, across conditions they were presented at the same distance (6 deg) from the vertical midline. This was to assess whether any effect of the pairs' separation in Experiments 1 through 3 might be attributable to change in distance from the vertical midline rather than separation from each other. The different positions used are schematized in Figure 3 and were chosen so that no separation condition was unique in the positions stimulated.

For Experiments 5 and 6, the objects were positioned in concentric circular trajectories centered on fixation (see Figure 4). Separation was varied by changing the radius of the two trajectories. This kept targets far apart from distractors and allowed larger separations than were possible with the previous experiments. Using a circular trajectory centered on fixation meant a target could be kept at the edge of the visual field. In Experiment 5, each of the two circular trajectories contained three red Gaussian blobs (evenly spaced 120°

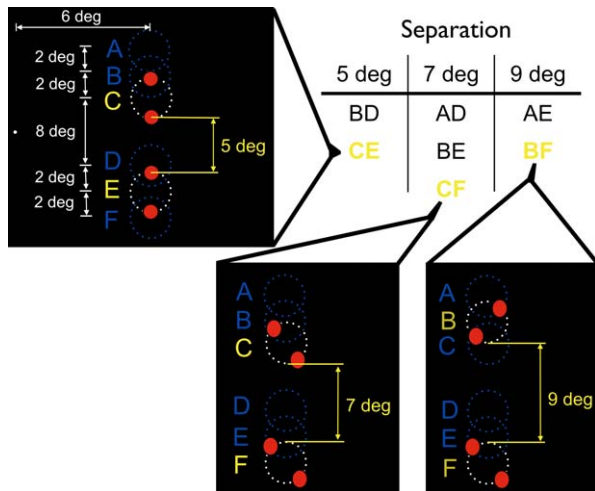

Figure 3. As in the previous experiments, in Experiment 4 two pairs of blobs were presented in each condition and moved along circular trajectories. Here however, the trajectories were always centered on points 6 deg lateral from the vertical midline, and 5, 7, or 9 deg separated the pairs. To address possible visual field inhomogeneity, multiple location conditions were devised for each separation. The conditions are tabulated here, and three of the conditions are highlighted in yellow.

apart from the others, because it initially was designed as a follow-up to Experiment 2 of Holcombe & Chen, (2012). To address the difference in the number of distractors between this experiment and the other experiments, four participants were also run with two objects in the trajectory (spaced 180° apart) rather than three. The data are not shown; they were analyzed separately, and a similar result was found—a large difference between the one- and two-target thresholds, slightly larger (not significantly so) than the one-distractor condition.

The purpose of Experiment 6 was to compare two separations, with one close to the maximum possible for the display. This was achieved by setting the radius of the outer trajectory such that it was at the edge of the visual field. Physically, the trajectory went along the edge of the CRT monitor but the viewing distance was reduced to 10 cm so that the CRT nearly spanned the visual field. The experimenter tested for visibility by moving the mouse pointer (which was smaller than the stimuli) about the trajectory. For participants whose visual field was too restricted to see the mouse pointer, the viewing distance was modified to 12 cm, which sufficed for all those participants. For these 12-cm viewing distance participants, the larger separation corresponded to 51 deg and the smaller to 18 deg. For the 10-cm viewing distance participants, these figures were 59 and 21 deg. Because vision is very poor in the far periphery, large radial grating segments were used rather than Gaussian blobs. In the inner trajectory, the

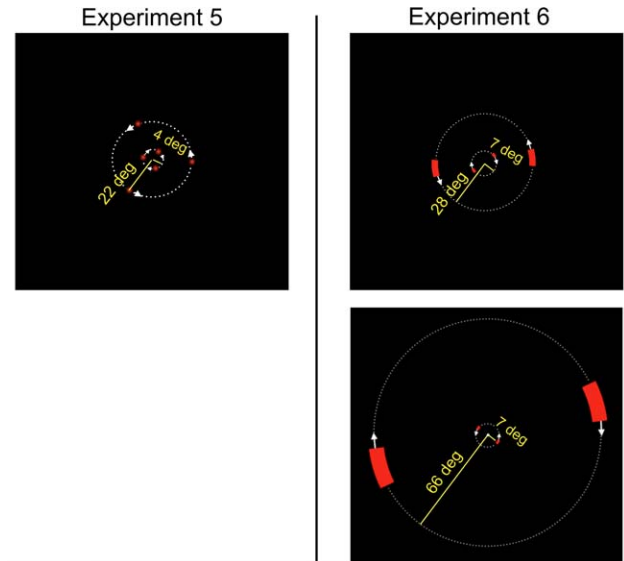

Figure 4. Display of Experiments 5 and 6. Two concentric circular trajectories were centered on fixation. Three red Gaussian blobs (in Experiment 5) or two arc segments were evenly spaced about the trajectory. In Experiment 5, the inner trajectory had a radius of 4 deg and the outer trajectory's radius was 22 deg. In Experiment 6, the inner trajectory had radius 7 deg. The outer trajectory had a radius of either 28 (top panel) or 66 deg (bottom panel), corresponding to a separation from the inner trajectory of 21 or 59 deg.

arc segments were 1.7 deg × 2.9 deg for the 10-cm viewing distance and 1.4 deg × 2.4 deg for the 12-cm viewing distance. For the outer trajectory, for the small separation the arc segments were 4.6 deg (3.8 deg) × 10.3 deg (8.6 deg) for the 10-cm (12-cm) viewing distance, whereas for the larger separation, the arc segments in the outer trajectory was 10.3 deg (8.6 deg) × 25.9 deg (21.7 deg) for the 10-cm (12-cm) viewing distance.

Procedure

Observers were instructed to maintain fixation on the white dot at the display center until the response phase. To indicate which blobs or arc segments were targets, for the first 0.7 s of the motion interval the color of the targets was white instead of red. For Experiment 6, light blue (CIE $x = 0.21$, $y = 0.30$, 23.5 cd/m²) was used because in the far periphery the white was difficult to discriminate from the red.

Following the cuing period was the tracking period, during which all the objects were red. To prevent participants from predicting the final target positions from their initial positions and speeds, the blobs occasionally reversed direction. Specifically, each pair

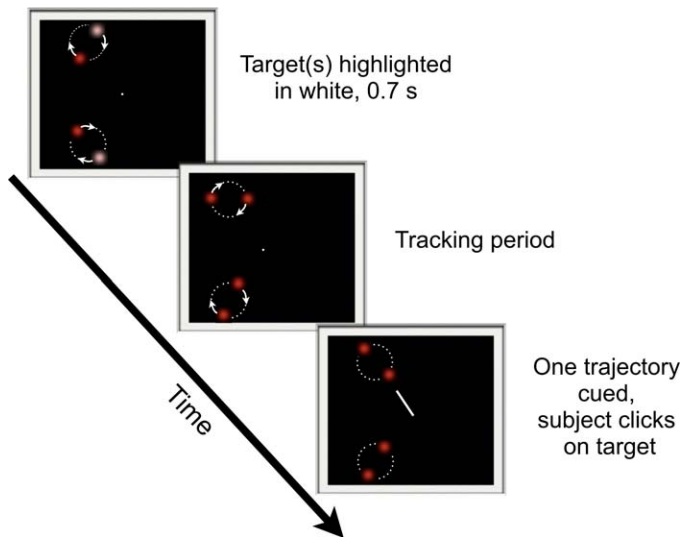

Figure 5. All objects moved continually along their trajectories. The target(s) were first highlighted in white for 0.7 s. After the objects stopped, one ring was indicated (in Experiments 1 through 4 by a white line, in Experiments 5 and 6 by a voice) and the participant is asked to click on the object that was the target in that ring.

of blobs was independently assigned a series of reversal times, which succeeded each other at random intervals between 1.2 and 2 s. After this tracking period, which was randomly set to between 3 and 3.8 s, all four blobs stopped rotating (Figure 5).

One or two objects were cued as targets. For the one-target condition, on half of trials, the target was in the upper trajectory and on the other half of trials it was in the lower trajectory (Experiments 1 through 4). For Experiments 5 and 6, the lone target of the one-target condition was in the inner trajectory on half of the trials and in the outer trajectory on the other half. In the two-targets condition, one blob of each trajectory was designated as a target. At the end of the trial, one trajectory was indicated and the task was to click on the target in that trajectory. This trajectory was indicated by a white line for Experiments 1 through 3 (see Figure 5), and for Experiments 4 through 6 by a sound recording of the first author saying “upper” or “lower” (Experiment 4) or “inner” or “outer” (Experiments 5 and 6). In the two-targets condition, on half of trials participants were cued to indicate the target in the upper (or inner) trajectory and on the other half of trials they were cued to the lower (or outer) trajectory.

A range of speeds from 0.3 to 2.7 rps was used on different trials, half being one-target conditions and half two-target conditions. The speeds for each condition and person were chosen based on the person’s performance in previous tracking sessions and/or experiments, when available. For Experiments 1 through 4, all blobs revolved at the same speed

throughout a given trial. For Experiment 5, the blobs in the outer trajectory moved 0.4 rps more slowly than those in the inner. For Experiment 6, the blobs in the outer trajectory moved 0.4 rps more slowly than those in the inner for the large separation condition, and moved 0.1 rps more slowly than those in the inner for the small separation condition. These speed differences were introduced because in pilot testing of Experiments 5 and 6, we noticed that speed thresholds for the outer ring were slower than that of the inner ring (when expressed in revolutions per second), in agreement with previous findings (Holcombe & Chen, 2012, 2013). This may be related to the jump size between successive frames being larger at the higher separation, owing to the greater linear speed at high eccentricity for a particular number of revolutions per second, together with the limited (160 Hz) refresh rate. Or even without these technical problems, speed thresholds in rps may decline with eccentricity, but that cannot be confirmed without a higher-fidelity display. In all results, the speeds are all reported in terms of the inner trajectory, for best comparison with Experiments 1 through 4.

In Experiments 5 and 6, four observers participated in at least 32 trials at each speed and 160 trials in total. For Experiments 1 through 4, each observer participated in at least 16 trials (Experiments 1 and 2) or 24 trials (Experiments 3 and 4) for each speed, separation, and number of tracked targets condition. Thus, the minimum total trials for each observer was 640 trials for Experiment 1; 480 trials for Experiment 2; 1,200 trials for Experiment 3; and 672 trials for Experiment 4. Each observer had 160, 168, or 200 trials per session (shorter than 50 min) and did no more than two sessions per day.

Data analysis

The anonymized raw data as well as the R code (R Core Team, 2013) that analyzed the data, computed the statistics, and generated all the figures are posted at <https://openscienceframework.org/project/t4vmy/>.

Plots of speed versus proportion correct were fit by logistic regression that spanned from chance (50% accuracy for Experiments 1 through 4 and Experiment 6 and 33% accuracy for the three-object condition of Experiment 5) to a ceiling level of performance. The ceiling was determined by the lapse rate, which is the probability of an incorrect response that is independent of speed (Prins, 2012), such as accidentally pressing the wrong key. In the curve-fitting procedure, the lapse rate was allowed to vary from 0% to 6% to get the best estimate for each condition and each participant. See Figure 6 for the data and fitted curves for Experiment 1.

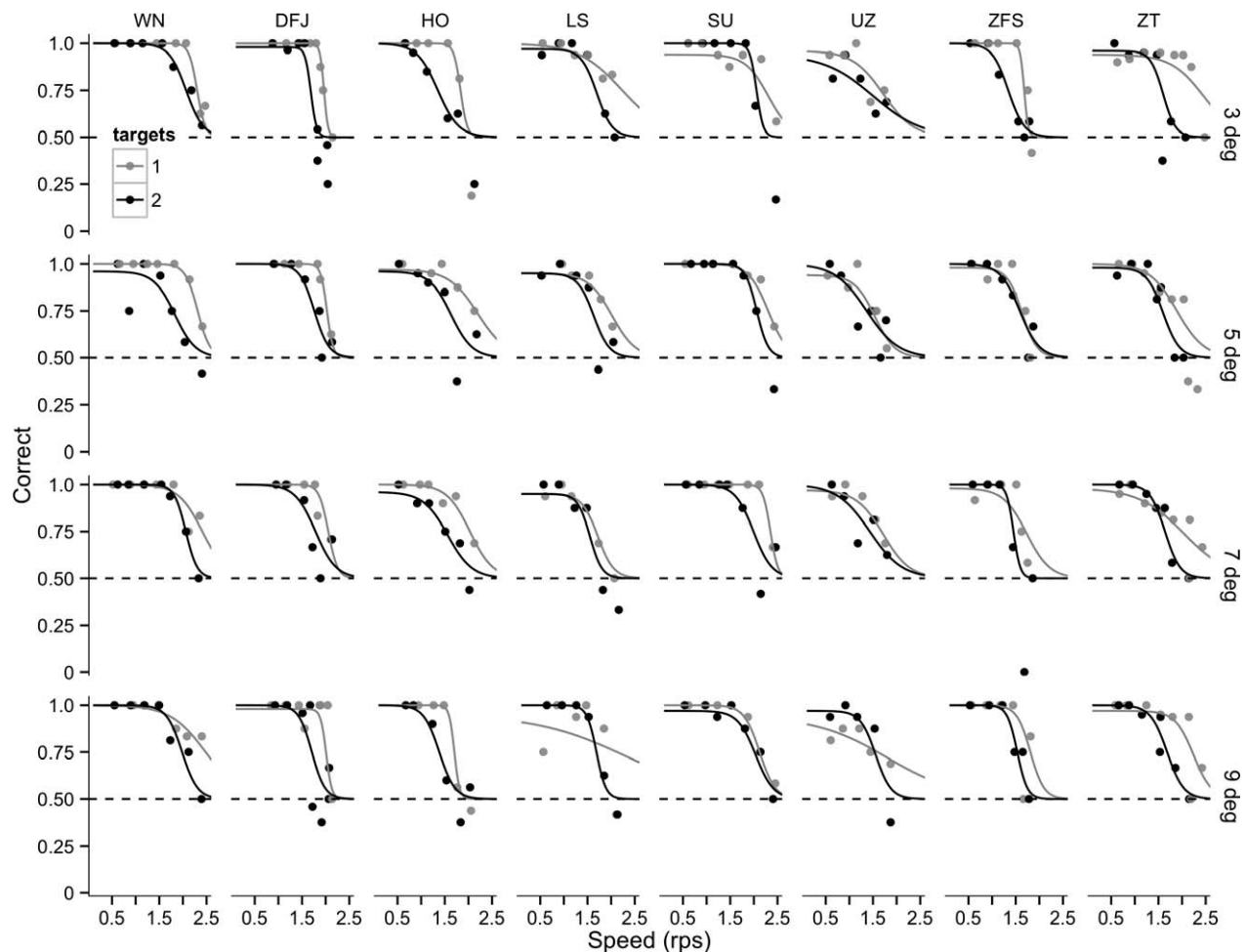

Figure 6. Data for Experiment 1. Mean proportion correct at each speed, for the one-target (gray) and two-target (black) conditions. Columns are participants, rows are separations. Curves are the result of logistic regression. Note that the two-target curves are usually shifted to the left relative to the one-target curves, so that the two-target speed thresholds (e.g., where performance falls to 80% correct) are usually slower. The initials shown are not the participants' real initials.

To perform logistic regression, we used least squares with a generalized linear model using logit as the link function. Because logistic regression is for dependent variables that go from zero to one, proportion correct was rescaled so that chance level to the ceiling imposed by the lapse rate corresponded to zero to one (Zychaluk & Foster, 2009). For example, with a 1% lapse rate and the chance level of 50%, the ceiling is 99.5% because at ceiling, on 99% of trials participants respond correctly while in the remaining 1% of trials, participants will respond randomly, giving a correct response 50% of the time.

The regression was performed using bias-reduced maximum likelihood (Firth, 1993; Kosmidis & Firth, 2009), yielding a best-fitting model for each lapse rate. The deviance of these models was then compared to arrive at the best-fitting lapse rate and corresponding model.

We refer to the speed at which performance is estimated by the regression to fall to 80% correct as the

“speed threshold.” At this level of performance, participants frequently can track both of the two targets. Not until performance falls to 75%, or sometimes less, are participants only able to track a single target (see Holcombe & Chen, 2012; Chen et al., 2013; Holcombe & Chen, 2013). Franconeri et al. (2013b) suggested that spatial interference between targets should not be assessed at a low performance level where participants may only be able to track one target, hence our choice of a relatively high performance level of 80%.

For the unique three-object condition of Experiment 5, the performance level corresponding to the two-object conditions' 80% is lower, because the chance rate is 33% instead of 50%. Linearly scaled, the accuracy equivalent to the two-object 80% level is 73% for three objects. To confirm that the pattern of differences across conditions also held at other performance levels, we also calculated the speed thresholds for 68%, 74%, and 86% correct (and their three-object equivalents) and plot them in the Appendix.

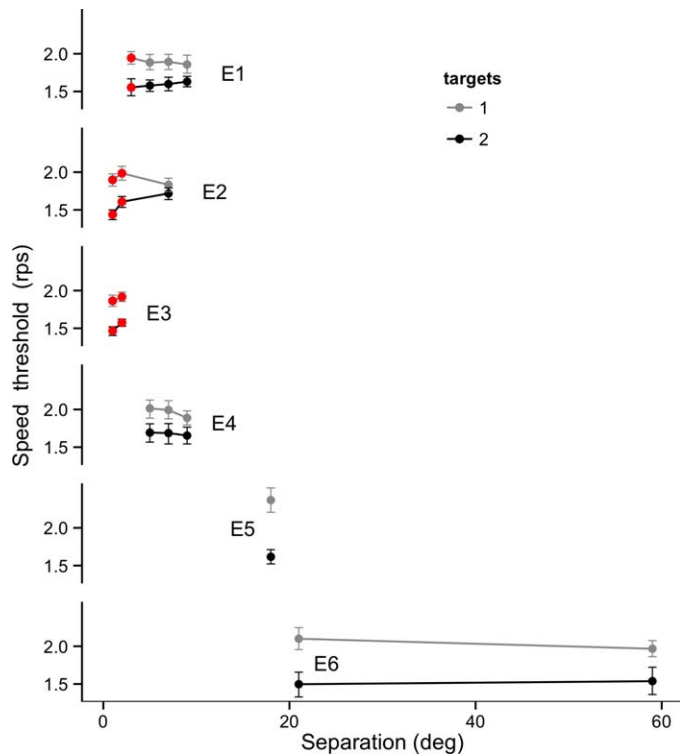

Figure 7. Mean 80% speed threshold in each experiment. Tracking two targets (black) yields worse thresholds than tracking one target (gray), even at large spatial separations. Inside the putative crowding zone (red symbols), thresholds improve with separation. Outside the crowding zone, the sole statistically significant effect of separation is in Experiment 4, where one-target thresholds significantly worsen with separation. Error bars show bootstrapped 68% confidence intervals (analogous to one standard error across participants). The Experiment 5 data are from the two-distractor condition; the one-distractor condition (the only condition run for all the other experiments) gave an even larger (although not significantly so) difference between the one- and two-target conditions.

The additional-target cost

The speed thresholds are plotted in Figure 7. To assess the effect of number of targets, the speed

thresholds were submitted to an ANCOVA with number of targets, separation, and their interaction as factors. Separate ANCOVAs were run for crowded separations and for the noncrowded separations (because separation was treated as a continuous rather than a categorical variable, the correct term for these are ANCOVAs rather than ANOVAs).

The effect of targets was significant in each case, with one exception, as shown in Table 2. An additional *t* test was done for the largest separation of the experiments with noncrowded conditions and is reported in the rightmost column. Because for Experiment 5 only one separation was tested, the ANOVA and *t* test are equivalent.

The exception to the finding of a significant targets effect was in the sole noncrowded separation tested in Experiment 2. The direction of the nonsignificant trend ($p = 0.13$) was for an additional-target cost (see Figure 7), as in all the other experiments and conditions.

Effect of separation

To assess the effect of separation on speed threshold inside the crowding zone versus outside it, separate ANCOVAs were run for the one-target condition and the two-target condition. For each, one analysis was run for the crowded separations and another for the noncrowded separations. The raw effect size, change in threshold (rps) per degree of separation, is reported as “*s*.”

Two-target speed thresholds

For the separations within the crowding range, as expected separation improved two-target speed thresholds markedly. Experiment 2: $F(1, 7) = 22.18, p = 0.002, s = 0.17$. Experiment 3: $F(1, 9) = 10.59, p = 0.010, s = 0.11$.

For the separations beyond the crowding range, according to long range spatial interference theory

Additional-target costs

Experiment	Crowded	Not crowded	Largest noncrowded separation
1	$F(1, 7) = 40.0, p < 0.001^*$	$F(1, 7) = 29.6, p = 0.001^*$	$t(7) = -2.62, p = 0.034^*$
2	$F(1, 7) = 78.1, p < 0.0001^*$	$F(1, 7) = 3.0, p = 0.129$	$t(7) = 1.72, p = 0.129$
3	$F(1, 9) = 193.7, p < 0.001^*$	NA	NA
4	NA	$F(1, 5) = 152.3, p < 0.001^*$	$t(5) = 7.59, p < 0.001^*$
5	NA	$F(1, 6) = 32.5, p = 0.001^*$	$t(6) = 5.70, p = 0.001^*$
6	NA	$F(1, 7) = 17.7, p = 0.004^*$	$t(7) = 3.18, p = 0.016^*$

Table 2. Statistics for each experiment’s additional-target cost. Notes: The crowded and noncrowded conditions are analyzed separately (columns), and also a *t* test is done for the largest separation of the noncrowded conditions (rightmost column). See text for statistical details. Asterisks indicate where $p < 0.05$.

thresholds should improve as separation increases even outside the crowding zone. But there were no significant effects of separation. For Experiment 1: $F(1, 7) = 0.967$, $p = 0.358$, $s = 0.013$. Experiment 4: $F(1, 5) = 2.11$, $p = 0.206$, $s = -0.01$. Experiment 6: $F(1, 7) = 0.94$, $p = 0.365$, $s = 0.001$.

One-target speed thresholds

Here because there was only one target, the separation is the minimum distance between the target and the nearest distractor of the other trajectory.

For the separations within the crowding range a trend was present for one-target thresholds to improve with separation, but this did not reach significance. Experiment 2: $F(1, 7) = 4.34$, $p = 0.076$, $s = 0.04$. Experiment 3: $F(1, 9) = 3.49$, $p = 0.095$, $s = 0.03$.

For the separations beyond the crowding range unexpectedly we found evidence that separation *impaired* one-target tracking performance. In all three experiments for which multiple separations were tested outside the crowding zone, one-target thresholds decreased with separation. This trend was significant for Experiment 6 but was not significant for Experiments 1 or 4. Experiment 6: $F(1, 7) = 9.02$, $p = 0.020$, $s = -0.003$. Experiment 1: $F(1, 7) = 0.11$, $p = 0.748$, $s = -0.01$. Experiment 4: $F(1, 5) = 5.833$, $p = 0.060$, $s = -0.031$.

Comparing the effect of separation on one-target versus two-target thresholds

The above statistics were from ANCOVAs conducted separately on the one-target and two-target conditions. In the crowded domain, separation significantly improved two-target performance but for one-target performance that trend was not significant. To test whether the effect of separation was significantly greater for the two-target condition than for the one-target condition, the data were submitted to a repeated-measures ANCOVA including both conditions so that the interaction could be tested (number of targets, separation, and their interaction were included in the model).

For separations within the crowding range the effect of separation was not significantly greater in the two-target condition than the one-target condition, but the difference did approach significance. Experiment 2: $F(1, 7) = 3.52$, $p = 0.103$. Experiment 3: $F(1, 9) = 3.89$, $p = 0.054$. Such an interaction would be consistent with the proposal that attending to an object results in an inhibitory surround, as attention to the two targets could then inhibit each other. This interaction is small, however, relative to the size of the additional-target

cost (see Figure 7), suggesting that crowding is not responsible for much of the additional-target cost.

For separations beyond the crowding zone the effect of separation was significantly different for the one-target condition compared to two targets for Experiment 6, $F(1, 7) = 11.74$, $p = 0.011$. Recall that this interaction reflects separation *impairing* one-target performance while apparently not affecting two-target performance. The interaction for Experiment 4 was in the same direction but was not significant, $F(1, 5) = 4.91$, $p = 0.078$. The interaction for Experiment 1 was also in the same direction but not significant, $F(1, 7) = 0.9$, $p = 0.369$.

Effect of speed may depend on number of targets

Franconeri et al. (2008, 2010) proposed that the cause of the additional-target cost is distinct from the cause of the deleterious effect of speed. From that proposal, they reasoned that the effect of speed should be the same regardless of the number of targets. To investigate the issue here, the slopes of the psychometric functions relating speed to proportion correct were submitted to ANCOVAs just as were the speed thresholds in the previous sections (performed separately for each experiment and for crowded and uncrowded conditions, with number of targets, separation, and their interaction included as factors).

The effect of speed was significantly different for the one-target and two-target conditions (that is, number of targets had a significant effect on slope), but only in Experiment 6, $F(1, 7) = 6.83$, $p = 0.035$, where the slope was shallower for the two-target condition. If corrected for multiple comparisons (e.g., based on doing six experiments), this p value should not be considered significant. However, all the nonsignificant trends were in the same direction (shallower slope for the two-target condition) for the other experiments. The numbers reported here were for the slope at the 80% proportion correct level, but the pattern was the same for the other levels analyzed in this paper (68%, 74%, and 86%). These slopes are plotted in Figure A1 in the Appendix, and the issue of different slopes is discussed further in the Discussion.

No evidence for a within-quadrant deficit

For the Experiment 3 1 deg separation conditions, three spatial arrangements were used within one quadrant, and in the remaining arrangement, the pairs were in distinct quadrants. Carlson et al. (2007) found evidence for a *within-quadrant deficit*—tracking targets in distinct quadrants yielded higher performance than

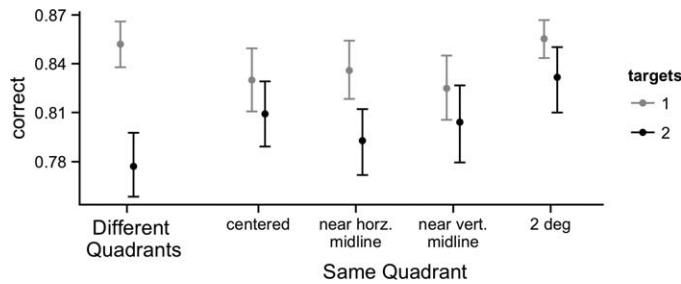

Figure 8. Proportion correct for the five distinct conditions of Experiment 3. Error bars show bootstrapped 68% confidence intervals between participants. The small disadvantage for the two-target different quadrants condition is not statistically significant (see text).

tracking targets in the same quadrant, even though spatial separation was the same.

Here, for the mean between-subjects proportion correct, performance was if anything *lower* when the two pairs of objects were in different quadrants rather than the same quadrant, $F(1, 9) = 2.76$, $p = 0.130$. That nonsignificant main effect is from the ANOVA, which did however yield a significant interaction. The ANOVA was repeated-measures with same quadrant and number of targets as factors, and their interaction was significant, $F(1, 9) = 8.92$, $p = 0.0153$. The main effect of the number of targets was also significant, $F(1, 9) = 20.75$, $p = 0.001$.

Regarding the interaction, it implies that being in the same quadrant had a different effect when tracking two targets than when tracking one target. In the critical two-target condition, the small tendency (difference of 2.5% correct) for performance to be worse when the targets were in different quadrants was not significant, $F(1, 9) = 3.10$, $p = 0.112$ (ANOVA conducted on the two-target condition only). In the one-target condition, the very small trend (difference of 1.6% correct) was in the opposite direction and was not significant, $F(1, 9) = 1.79$, $p = 0.214$ (ANOVA conducted on the one-target condition only).

The results are broken out into the five distinct configurations in Figure 8, with the lone different-quadrants condition on the left. The three same-quadrant conditions with 1 deg of separation yielded similar levels of performance, indicating that the small possible same-quadrant advantage was not caused by a specific retinal location. The stimuli and spatial arrangement of the displays differed significantly from that of Carlson et al. (2007), and it is unclear which factor is responsible for the discrepancy with their results.

Tracking accuracy was higher on average when the stimuli were presented in the right hemifield (Experiments 1 through 4), which is reported and discussed in

the Appendix under the heading “Right hemifield advantage, particularly when tracking only one target.”

In Experiments 5 and 6, the display configuration involved an inner ring of objects and an outer ring. There was no main effect of ring, but some evidence of a three-way interaction with separation and target number, which is reported and discussed in the Appendix.

Discussion

Six experiments investigated the effect of spatial separation on the ability to track one or two targets. The results indicate that tracking is impaired when objects are near each other. The range of this spatial interference is consistent with findings in the crowding literature.

At large separations there is no sign of spatial interference, but performance tracking two targets remains much poorer than for one target. This suggests that some hemifield-wide process is less able to track two targets than one. We use the term “resource” to refer to such a process.

This nonspatial resource, if it is cross-modal, can explain findings of interference between nonvisual tasks and tracking (Tombu & Seiffert, 2008). However, such dual-task findings might alternatively be explained by an executive control component of tracking and the other tasks that must alternate between tasks, but need not switch among the targets of a single task.

Franconeri et al. (2008, 2013b) had proposed that spatial interference was the sole cause of the additional-target cost. Our evidence that spatial interference is confined to the crowding range contradicts their theory. We cannot entirely rule out an effect of separation over large distances, but our results establish that it would have to be small relative to the additional-target cost, for even at the 58 deg separation, the additional-target cost remained robust.

Our experiments primarily varied target-target separation, because the putative long-range spatial interference was proposed to occur specifically among targets (Franconeri et al., 2010), rather than between targets and distractors. An anonymous reviewer suggested that target-distractor interference might somehow mask the effects of target-target separation. But in Experiment 6 both target-target and target-distractor separation were varied together, and still there was no significant effect on two-target performance. Holcombe and Chen (2012) used a similar manipulation (over a smaller range), with the same result.

These experiments used circular trajectories exclusively, and we cannot be sure that other trajectories

would yield the same results. This is discussed in the “Potential idiosyncrasy of circular motion” section of the Appendix.

Why does separation sometimes impair one-target tracking?

Surprisingly, we found evidence that tracking one target is harder when that target is *farther* from the other (nontarget) pair of objects. This of course runs contrary to the spatial interference theory.

Rather than operating solely on retinotopic representations, tracking also involves scene-based or configural position representations (Liu et al., 2005; Howe, Pinto, & Horowitz, 2010; Howe, Drew, Pinto, & Horowitz, 2011) that may be affected by all the objects in the display. These nonretinotopic, configural localization processes may possibly be impaired by separation among the display objects. At large separations, configural processing may be less effective due to the limited size of receptive fields. However, this by itself does not explain why the impairment with separation did not occur in the two-target condition.

One possible explanation is that attending to an object in both trajectories (the two-target condition) rescues the configural processing that otherwise drops out at the larger separations. This is speculation, but attending to an object in both trajectories may group them together (Yantis, 1992; Fehd & Seiffert, 2008) or in another way facilitate their contribution to configural processing.

Understanding the nature of the resource

While the present results support the *existence* of a resource limitation, they do not provide any mechanistic insights into the nature of the resource. As Franconeri and colleagues have emphasized (Franconeri, 2013; Franconeri et al. 2013a, 2013b), to make scientific progress we must move beyond generic resource theory to something more specific.

One viable possibility is that tracking depends on a population of neurons that are divided among the targets and process them in parallel. An alternative that makes more predictions is serial switching theory. The predictions of serial switching theory are consistent with the quantitative effect of load on temporal frequency limits (Holcombe & Chen, 2013), and the evidence for intermittent attentional sampling (VanRullen & Dubois, 2011) lends the theory additional credibility. The theory is also consistent with the absence of spatial separation effects outside the crowding range, because in several paradigms shifting attention across a larger distance among targets is no

more costly than shifting it a short distance (Remington & Pierce, 1984; Sagi & Julesz, 1985; Kwak, Dagenbach, & Egeth, 1991; Sperling & Weichselgartner, 1995; cf. Egly & Homa, 1991).

This simple serial switching theory makes no prediction regarding the effect of load on speed limits. Although researchers sometimes write that serial switching theory does predict a speed effect (e.g., Oksama & Hyona, 2008), by itself it predicts only a temporal frequency limit (see Holcombe & Chen, 2013 for discussion).

But during MOT, attention must not only shift. It also must find the object nearest to the last-sampled location. This search process may take longer or be more prone to error the farther the object (the target) has moved, causing performance to decline with speed. This would allow the serial switching theory to accommodate the decline in speed thresholds for higher target loads. See the Appendix section “How does speed impair tracking performance?” for more discussion of the effect of speed.

Parallel processing theories of tracking are currently more popular than serial theories, and are favored by some results (Howe, Cohen, Pinto, & Horowitz, 2010). Borisyuk, Chik, and Kazanovich (2008) described two neural network models, both of which involve parallel processing of targets. The two models both perform more poorly for higher target speeds. Neither network was designed to model the basic finding of poorer performance with more targets, but they might be modified to accommodate the divisible resource concept. They both involve central, nonspatially specific units that synchronize and resonate with peripheral retinotopic units. The active peripheral retinotopic units must change more quickly if the target moves quickly, and the rate at which the units change might be boosted if more central units were allocated to a particular target.

In one theory of attention, the division of resource and its deleterious consequences are closely linked to divisive normalization (Reynolds & Heeger, 2009). Peripheral units representing attended targets form a pool that normalizes the gain of individual neurons, such that the greater the number of attended targets, the lower the gain of each neuron (Ma & Huang, 2009). This is already a critical part of certain accounts of visual working memory limitations (Wei, Wang, & Wang, 2012; Keshvari, van den Berg, & Ma, 2013), and lower gain can result in poorer precision of sensory population codes (Pouget, Dayan, & Zemel, 2003). Future modeling efforts should explore the possible consequences of reduced gain for keeping attention on fast-moving targets.

Keywords: multiple object tracking, attention, attentional tracking, speed, crowding

Acknowledgments

This research was supported by Australian Research Council grants DP110100432, FT0990767, and DP140100952 to AOH. We thank Patrick Cavanagh and Brian Scholl for insightful comments.

Commercial relationships: none.

Corresponding author: Alex O. Holcombe.

Email: alex.holcombe@sydney.edu.au.

Address: School of Psychology, University of Sydney, Australia.

References

- Allen, R., McGeorge, P., Pearson, D., & Milne, A. (2004). Attention and expertise in multiple target tracking. *Applied Cognitive Psychology, 18*, 337–347.
- Allen, R., McGeorge, P., Pearson, D., & Milne, A. (2006). Multiple-target tracking: A role for working memory? *Quarterly Journal of Experimental Psychology, 59*, 1101–1116.
- Alvarez, G. A., & Cavanagh, P. (2005). Independent resources for attentional tracking in the left and right visual hemifields. *Psychological Science, 16*(8), 637–643, doi:10.1111/j.1467-9280.2005.01587.x.
- Alvarez, G. A., & Franconeri, S. L. (2007). How many objects can you track? Evidence for a resource-limited attentive tracking mechanism. *Journal of Vision, 7*(13):14, 1–10, <http://www.journalofvision.org/content/7/13/14>, doi:10.1167/7.13.14. [PubMed] [Article]
- Alvarez, G., Horowitz, T., Arsenio, H., DiMase, J., & Wolfe, J. (2005). Do multielement visual tracking and visual search draw continuously on the same visual attention resources? *Journal of Experimental Psychology: Human Perception & Performance, 31*, 643–667.
- Bae, G. Y., & Flombaum, J. I. (2012). Close encounters of the distracting kind: Identifying the cause of visual tracking errors. *Attention, Perception, & Psychophysics, 74*(4), 703–715, doi:10.3758/s13414-011-0260-1.
- Bahcall, D. O., & Kowler, E. (1999). Attentional interference at small spatial separations. *Vision Research, 39*, 71–86.
- Bates, D., Maechler, M., Bolker, B., & Walker, S. (2013). lme4: Linear mixed-effects models using Eigen and S4. R package (Version 1.0-4). Retrieved from <http://CRAN.R-project.org/package=lme4>
- Borisjuk, R., Chik, D., & Kazanovich, Y. (2008). Selective attention model of moving objects. *Artificial Neural Networks-ICANN, 2008*(5164), 429–445.
- Bouma, H. (1970). Interaction effects in parafoveal letter recognition. *Nature, 226*(5241), 177–178, doi:10.1038/226177a0.
- Burr, D. C., & Ross, J. (1982). Contrast sensitivity at high velocities. *Vision Research, 22*, 479–484.
- Carlson, T. A., Alvarez, G. A., & Cavanagh, P. (2007). Quadratic deficit reveals anatomical constraints on selection. *Proceeding of the National Academy of Sciences, USA, 104*(33), 13496–13500, doi:10.1073/pnas.0702685104.
- Cavanagh, P., & Alvarez, G. A. (2005). Tracking multiple targets with multifocal attention. *Trends in Cognitive Sciences, 9*(7), 349–354.
- Chen, W. Y., Howe, P. D., & Holcombe, A. O. (2013). Resource demands of object tracking and differential allocation of the resource. *Attention, Perception, & Psychophysics, 75*(4), 710–725. doi:10.3758/s13414-013-0425-1
- Cutzu, F., & Tsotsos, J. K. (2003). The selective tuning model of attention: psychophysical evidence for a suppressive annulus around an attended item. *Vision Research, 43*(2), 205–219.
- Egly, R., & Homa, D. (1991). Reallocation of visual attention. *Journal of Experimental Psychology: Human Perception & Performance, 17*, 142–159.
- Ericson, J. M., & Christensen, J. C. (2012). Reallocating attention during multiple object tracking. *Attention, Perception, & Psychophysics, 74*(5), 831–840.
- Falkner, A. L., Krishna, B. S., & Goldberg, M. E. (2010). Surround suppression sharpens the priority map in the lateral intraparietal area. *The Journal of Neuroscience, 30*(38), 12787–12797.
- Fehd, H. M., & Seiffert, A. E. (2008). Eye movements during multiple object tracking: Where do participants look? *Cognition, 108*, 201–209.
- Feria, C. S. (2013). Speed has an effect on multiple-object tracking independently of the number of close encounters between targets and distractors. *Attention, Perception, & Psychophysics, 75*(1), 53–67, doi:10.3758/s13414-012-0369-x.
- Firth, D. (1993). Bias reduction of maximum likelihood estimates. *Biometrika, 80*, 27–38.
- Franconeri, S. L. (2013). The nature and status of visual resources. In D. Reisberg (Ed.), *The Oxford handbook of cognitive psychology* (Vol. 8481). New York: Oxford University Press.
- Franconeri, S. L., Alvarez, G. A., & Cavanagh, P.

- (2013a). Flexible cognitive resources: Competitive content maps for attention and memory. *Trends in Cognitive Sciences*, 17(3), 134–141, doi:10.1016/j.tics.2013.01.010.
- Franconeri, S. L., Alvarez, G. A., & Cavanagh, P. (2013b). Resource theory is not a theory: A reply to Holcombe. Online comment on *Trends in Cognitive Sciences*, 17(3), 134–141, [http://www.cell.com/trends/cognitive-sciences/abstract/S1364-6613\(13\)00024-7#Comments](http://www.cell.com/trends/cognitive-sciences/abstract/S1364-6613(13)00024-7#Comments).
- Franconeri, S. L., Alvarez, G. A., & Enns, J. T. (2007). How many locations can be selected at once? *Journal of Experimental Psychology: Human Perception & Performance*, 33(5), 1003–1012, doi:10.1037/0096-1523.33.5.1003.
- Franconeri, S. L., Jonathan, S. V., & Scimeca, J. M. (2010). Tracking multiple objects is limited only by object spacing, not by speed, time, or capacity. *Psychological Science*, 21(7), 920–925, doi:10.1177/0956797610373935.
- Franconeri, S. L., Lin, J. Y., Pylyshyn, Z. W., Fisher, B., & Enns, J. T. (2008). Evidence against a speed limit in multiple-object tracking. *Psychonomic Bulletin & Review*, 15(4), 802–808, doi:10.3758/PBR.15.4.802.
- Gurnsey, R., Roddy, G., & Chanab, W. (2011). Crowding is size and eccentricity dependent. *Journal of Vision*, 11(7):15, 1–17, <http://www.journalofvision.org/content/11/7/15>, doi:10.1167/11.7.15. [PubMed] [Article]
- Halko, M. A., Mingolla, E., & Somers, D. C. (2008). Multiple mechanisms of illusory contour perception. *Journal of Vision*, 8(11):17, 1–17, <http://www.journalofvision.org/content/8/11/17>, doi:10.1167/8.11.17. [PubMed] [Article]
- Holcombe, A. O. (2009). Seeing slow and seeing fast: Two limits on perception. *Trends in Cognitive Sciences*, 13(5), 216–221.
- Holcombe, A. O., & Chen, W. (in preparation). Speed limits and temporal frequency limits on multiple object tracking.
- Holcombe, A. O., & Chen, W. (2013). Splitting attention reduces temporal resolution from 7 Hz for tracking one object to <3 Hz when tracking three. *Journal of Vision*, 13(1):12, 1–19, <http://www.journalofvision.org/content/13/1/12>, doi:10.1167/13.1.12. [PubMed] [Article]
- Holcombe, A. O., & Chen, W. Y. (2012). Exhausting attentional tracking resources with a single fast-moving object. *Cognition*, 123(2), 218–228. doi:10.1016/j.cognition.2011.10.003.
- Hopf, J. M., Boehler, C. N., Luck, S. J., Tsotsos, J. K., Heinze, H. J., & Schoenfeld, M. A. (2006). Direct neurophysiological evidence for spatial suppression surrounding the focus of attention in vision. *Proceedings of the National Academy of Sciences of the United States of America*, 103(4), 1053–1058.
- Horowitz, T. S., Klieger, S. B., Fencsik, D. E., Yang, K. K., Alvarez, G. A., & Wolfe, J. M. (2007). Tracking unique objects. *Perception & Psychophysics*, 69(2), 172–184.
- Howe, P. D. L., Drew, T., Pinto, Y., & Horowitz, T. S. (2011). Remapping attention in multiple object tracking. *Vision Research*, 51(5), 489–95.
- Howe, P. D. L., Cohen, M. A., Pinto, Y., & Horowitz, T. S. (2010). Distinguishing between parallel and serial accounts of multiple object tracking. *Journal of Vision*, 10(8):11, 1–13, <http://www.journalofvision.org/content/10/8/11>, doi:10.1167/10.8.11. [PubMed] [Article]
- Howe, P. D. L., Pinto, Y., & Horowitz, T. S. (2010). The coordinate systems used in visual tracking. *Vision Research*, 50, 2375–2380.
- Howe, P. D., Horowitz, T. S., Wolfe, J., & Livingstone, M. S. (2009). Using fMRI to distinguish components of the multiple object-tracking task. *Journal of Vision*, 9(4):10, 1–11, <http://www.journalofvision.org/content/9/4/10>, doi:10.1167/9.4.10. [PubMed] [Article]
- Hübner, R., Volberg, G., & Studer, T. (2007). Hemispheric differences for global/local processing in divided attention tasks: Further evidence for the integration theory. *Perception & Psychophysics*, 69(3), 413–421.
- Hudson, C., Howe, P. D. L., & Little, D. R. (2012). Hemifield effects in multiple identity tracking. *PLoS ONE*, 7(8): e43796.
- Intriligator, J., & Cavanagh, P. (2001). The spatial resolution of visual attention. *Cognitive Psychology*, 43(3), 171–216, doi:10.1006/cogp.2001.0755.
- Keshvari, S., van den Berg, R., & Ma, W. J. (2013). No evidence for an item limit in change detection. *PLoS Computational Biology*, 9(2), e1002927. doi:10.1371/journal.pcbi.1002927.
- Kosmidis, I. (2013). brglm: Bias reduction in binary-response Generalized Linear Models. Retrieved from <http://www.ucl.ac.uk/~ucakiko/software.html>
- Kosmidis, I., & Firth, D. (2009). Bias reduction in exponential family nonlinear models. *Biometrika*, 96(4), 793–804.
- Kwak, H., Dagenbach, D., & Egeth, H. (1991). Further evidence for a time-independent shift of the focus of attention. *Perception & Psychophysics*, 5, 473–480.
- Levi, D. M. (2008). Crowding—an essential bottleneck for object recognition: A mini-review. *Vision*

- Research*, 48(5), 635–654, doi:10.1016/j.visres.2007.12.009.
- Lo, S.-Y., & Holcombe, A. O. (2013). How do we select multiple features? Transient costs for selecting two colors rather than one, persistent costs for color-location conjunctions. *Attention, Perception, & Psychophysics*, 31(2), 235–247, doi:10.3758/s13414-013-0573-3.
- Liu, G., Austen, E. L., Booth, K. S., Fisher, B. D., Argue, R., Rempel, M. I., & Enns, J. T. (2005). Multiple-object tracking is based on scene, not retinal, coordinates. *Journal of Experimental Psychology: Human Perception & Performance*, 31(2), 235–247, doi:10.1037/0096-1523.31.2.235.
- Ma, W., & Huang, W. (2009). No capacity limit in attentional tracking: Evidence for probabilistic inference under a resource constraint. *Journal of Vision*, 9(11):3, 1–30, <http://www.journalofvision.org/content/9/11/3>, doi:10.1167/9.11.3. [PubMed] [Article]
- Mesulam, M. M. (1999). Spatial attention and neglect: Parietal, frontal and cingulate contributions to the mental representation and attentional targeting of salient extrapersonal events. *Philosophical Transactions of the Royal Society of London, Series B: Biological Sciences*, 354(1387), 1325–1346.
- Oksama, L., & Hyönä, J. (2008). Dynamic binding of identity and location information: a serial model of multiple identity tracking. *Cognitive Psychology*, 56(4), 237–283.
- Peirce, J. W. (2007). PsychoPy—Psychophysics software in Python. *Journal of Neuroscience Methods*, 162(1–2), 8–13, doi:10.1016/j.jneumeth.2006.11.017.
- Pelli, D. G., & Tillman, K. A. (2008). The uncrowded window of object recognition. *Nature Neuroscience*, 11(10), 1129–1135, doi:10.1038/nn.2187.
- Pouget, A., Dayan, P., & Zemel, R.S. (2003). Inference and computation with population codes. *Annual Review of Neuroscience*, 26, 381–410.
- Prins, N. (2012). The psychometric function: The lapse rate revisited. *Journal of Vision*, 12(6):25, 1–1, <http://www.journalofvision.org/content/12/6/25>, doi:10.1167/12.6.25. [PubMed] [Article]
- Pylyshyn, Z. (1989). The role of location indexes in spatial perception: A sketch of the FINST spatial-index model. *Cognition*, 32(1), 65–97.
- Pylyshyn, Z. W. (2003). *Seeing and visualizing: It's not what you think*. Cambridge, MA: MIT Press.
- Pylyshyn, Z. W., & Storm, R. W. (1988). Tracking multiple independent targets: Evidence for a parallel tracking mechanism. *Spatial Vision*, 3(3), 179–197.
- R Core Team. (2013). *R: A language and environment for statistical computing*. Vienna, Austria: R Foundation for Statistical Computing. Retrieved from <http://www.R-project.org/>
- Remington, R. W., & Pierce, L. (1984). Moving attention: Evidence for time-invariant shifts of visual selective attention. *Perception & Psychophysics*, 35, 393–399.
- Reynolds, J. H., & Heeger, D. J. (2009). The normalization model of attention. *Neuron*, 61(2), 168–185.
- Robertson, L. C., Lamb, M. R., & Knight, R. T. (1988). Effects of lesions of temporo-parietal junction on perceptual and attentional processing in humans. *Journal of Neuroscience*, 8, 3757–3769.
- Sagi, D., & Julesz, B. (1985). Fast noninertial shifts of attention. *Spatial Vision*, 2, 141–149.
- Schall, J. D., Sato, T. R., Thompson, K. G., Vaughn, A. A., & Juan, C. H. (2004). Effects of search efficiency on surround suppression during visual selection in frontal eye field. *Journal of Neurophysiology*, 91(6), 2765–2769.
- Scholl, B. J. (2009). What have we learned about attention from multiple object tracking (and vice versa)? In D. Dedrick & L. Trick (Eds.), *Computation, cognition, and Pylyshyn* (pp. 49–78). Cambridge, MA: MIT Press.
- Schweickert, R. (1985). Separable effects of factors on speed and accuracy: Memory scanning, lexical decision, and choice tasks. *Psychological Bulletin*, 97, 530–546.
- Shim, W. M., Alvarez, G. A., & Jiang, Y. V. (2008). Spatial separation between targets constrains maintenance of attention on multiple objects. *Psychonomic Bulletin & Review*, 15(2), 390–397, doi:10.3758/PBR.15.2.390.
- Shipley, T. F., & Kellman, P. J. (1992). Strength of visual interpolation depends on the ratio of physically specified to total edge length. *Perception & Psychophysics*, 52(1), 97–106.
- Sperling, G., & Weichselgartner, E. (1995). Episodic theory of the dynamics of spatial attention. *Psychological Review*, 102, 503–532.
- Tombu, M., & Seiffert, A. E. (2008). Attentional costs in multiple-object tracking. *Cognition*, 108(1), 1–25.
- Tombu, M., & Seiffert, A. E. (2011). Tracking planets and moons: Mechanisms of object tracking revealed with a new paradigm. *Attention, Perception, & Psychophysics*, 73, 738–750, doi:10.3758/s13414-010-0060-z.
- Tripathy, S. P., Ogmen, H., & Narasimhan, S. (2011). Multiple-object tracking: A serial attentional process? In C. Mole, D. Smithies, & W. Wu (Eds.),

Attention: Philosophical and psychological essays.
New York: Oxford University Press.

- van Rossum, G., & Drake, F. L. (2001). Python reference manual. Virginia: PythonLabs. Available at <http://www.python.org>.
- VanRullen, R., & Dubois, J. (2011). The psychophysics of brain rhythms. *Frontiers in Psychology*, 2, 1–10, doi:10.3389/fpsyg.2011.00203.
- Verstraten, F. A. J., Cavanagh, P., & Labianca, A. (2000). Limits of attentive tracking reveal temporal properties of attention. *Vision Research*, 40(26), 3651–3664.
- Wei, Z., Wang, X. J., & Wang, D. H. (2012). From distributed resources to limited slots in multiple-item working memory: A spiking network model with normalization. *Journal of Neuroscience*, 32, 11228–11240.
- Wolfe, J. M., Place, S. S., & Horowitz, T. S. (2007). Multiple object juggling: Changing what is tracked during extended multiple object tracking. *Psychonomic Bulletin & Review*, 14(2), 344–349.
- Yantis, S. (1992). Multielement visual tracking: Attention and perceptual organization. *Cognitive Psychology*, 24(3), 295–340.
- Zychaluk, K., & Foster, D. H. (2009). Model-free estimation of the psychometric function. *Attention, Perception, & Psychophysics*, 71(6), 1414–1425. doi:10.3758/APP.71.6.1414.

Appendix

How does speed impair tracking performance?

Franconeri et al. (2010) suggested that the primary reason increases in speed impair performance in typical MOT displays is because faster objects travel farther and therefore are involved in more close encounters. However, Tombu and Seiffert (2011) and Feria (2013) held close encounters constant across speeds yet nevertheless found that increasing speed reduced performance markedly. If speed impairs tracking performance independently of increases in spatial interference, what is the reason for this effect of speed?

Even in the visual system's early stages, higher speeds yield weaker signals, and these surely feed into tracking processes. These deleterious effects of speed for low-level motion processing seem not to reflect a speed limit, but rather occur because increasing the speed of a stimulus also increases its temporal frequency (Burr & Ross, 1982). Attentional tracking also has a temporal frequency limit, one much lower than the limit both on direction discrimination

(Verstraten, Cavanagh, & Labianca, 2000; Holcombe & Chen, 2013) and several other perceptual abilities (Holcombe, 2009). Thus the deleterious effect of speed in tracking is at least partly caused by a temporal resolution constraint. This may be a constraint that limits visual cognition generally (Holcombe, 2009). The temporal limit likely results in temporal confusion errors—a distractor is confused with a target because it occupies the target's former location soon after the target moves on. Note that if spatial interference were the only cause of tracking errors (Franconeri et al., 2008, 2010, 2013a, 2013b; Franconeri, 2013), one would instead expect spatial confusions only, rather than these temporal confusions.

Attentional tracking may also have a speed limit in addition to its temporal frequency limit (Verstraten et al., 2000; Holcombe & Chen, 2013; Holcombe & Chen, in preparation) that manifests in conditions where the stimulus temporal frequency is low, like the present experiments. This limit was discovered with circular trajectories, and appears to be a rotational speed limit, in that the limit (in rps) changes little when the radius of the trajectory is increased, despite the resulting increase in linear speed. Like the temporal frequency limit, this speed limit appears not to reflect a basic motion perception constraint (Verstraten et al., 2000). Tracking's speed limits instead appear to be imposed by higher-order, possibly tracking-specific processing.

The temporal frequency limit is worse when more targets must be tracked, and this is consistent with a serial attention switching theory of tracking (Holcombe & Chen, 2013), according to which attention must sample each target in turn. Indeed, this quantitatively predicts the decrease in the temporal frequency limit of tracking. However, the theory makes no prediction of a speed limit. Explaining the speed limit will thus require additional assumptions.

Franconeri et al. (2010) suggested that the processes that perform more poorly at higher speeds sit at a different stage than those that perform more poorly when more targets are present. They suggested this in the context of a spatial interference theory that our evidence here contradicts, but nevertheless, the possibility that the effect of speed comes from a tracking process that is not directly affected by the number of targets remains viable. Combining this theory with additive-factors logic (Schweickert, 1985), Franconeri et al. (2010) made an interesting prediction.

Their prediction is that the effect of speed on tracking ability should be the same for different numbers of targets. The basic idea is that if two factors (here, speed and number of targets) affect separate processes, they will have independent and therefore additive effects on performance. The slope of the psychometric function (relating speed to percent correct) ought then to be the same for conditions with

different numbers of targets. Yet as reported in the Results, here we found that in all but one of our six experiments, there was a trend for slopes to be shallower in the two-target condition. For Experiment 6 the trend was statistically significant. These findings replicate the nonsignificant trend observed by Franconeri et al. (2010). The slopes are plotted in Figure A1.

Based on the additive-factors logic advocated by Franconeri et al. (2010), a difference in slopes should lead one to conclude that speed and the number of targets interact by affecting a common process. However, use of additive-factors logic is dubious for the tracking task because of contamination of slopes by a strategy reported by some participants.

When participants allocate their attention to two fast-moving targets, they may lose one before they lose the other. It appears that participants can at least sometimes recognize that they are no longer successfully tracking a target (Horowitz et al., 2007). Participants may then allocate all their attention to the remaining target. In such trials, participants spent some of the trial with a two-target load and the remainder of the trial with effectively a one-target load. These ideas are supported by the findings of Wolfe, Place, and Horowitz (2007), Ericson and Christensen (2012), and Chen et al. (2013) that the resource can be successfully reallocated during a trial.

In resource theory terms, a participant in this scenario will have spent some of the trial with 50% of their tracking resource on each target and the remainder of the trial with 100% of the resource on each target. This situation of participants giving up on one of the targets may occur even more frequently than only in those trials where they lose one of the targets, because participants may learn to recognize the speeds at which they can only track one target, and thus give up on one target during the cuing period, before the tracking interval even begins.

The resulting psychometric function of these situations will be a combination of the desired two-target psychometric function (50% of resource on a target) at slow speeds, the one-target psychometric function at higher speeds, and chance (for those trials where participants allocate all their resource to one target, but the other target is queried). Performance is then partly an average of two psychometric functions that are horizontally shifted with respect to each other. The resulting psychometric function should be shallower than that of the one-target condition. This could explain our finding of shallower slopes for the two-target condition, although this was only significant in Experiment 6.

The true (uncontaminated by the strategy mentioned above) effect of speed (slope of the psychometric function) with two targets remains unknown, and unfortunately there is a further complication. The one-

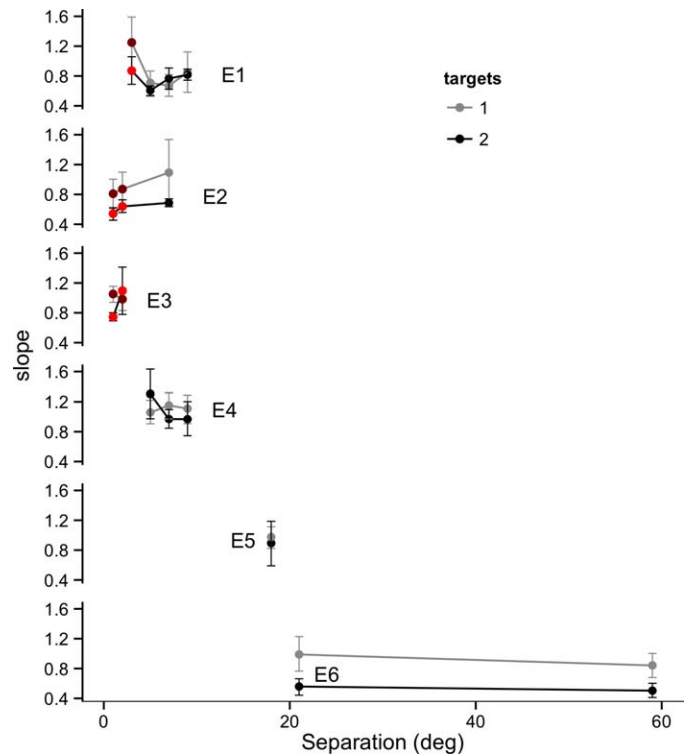

Figure A1. Mean slope magnitude of the psychometric curves, at the 80% correct level. The trend was for tracking two targets (black) to yield a slightly shallower slope than tracking one target (gray), but this was statistically significant only for Experiment 6. Data points corresponding to inside the putative crowding zone are tinted red. Error bars show 68% bootstrapped confidence intervals (analogous to one *SE* across participants).

target speed thresholds may unfortunately be partially constrained by lower-level perceptual factors or display artifacts. A consequence of the ≤ 160 Hz refresh rate used here is that the interframe stimulus displacement is perceivable at the high speeds around the one-target threshold, and this displacement may decrease the strength of low-level motion signals.

Potential idiosyncrasy of circular motion

Because we used only circular trajectories, we cannot be sure that our results will generalize to linear trajectories. Typically in the MOT literature, studies use more random trajectories, often composed entirely of straight segments. This is certainly different from the present study, but it is important to consider that the traditional displays also usually contain a rotational component, in that objects begin moving in one direction but often have periods moving in the near-opposite direction, so that targets and distractors exchange places. It remains unknown what aspect of typical MOT displays most limits performance at high

speeds. Only circular motion has been psychophysically isolated. A speed limit for it is well documented (Verstraten et al., 2000; Holcombe & Chen, 2013). Isolating linear motion is more difficult, because it rapidly takes objects out of the field of view.

An anonymous reviewer suggested that our displays might conflate element motion with surface motion—that is, the target and distractor could be perceived as two objects on an invisible surface that is rotating. This may be plausible in the displays of Experiments 1 through 4, but we think it is highly unlikely in the case of Experiments 5 and 6. In Experiments 5 and 6, the distances between the objects are so large that the ratio of the visible elements to the distance between them is small. According to the surface interpolation literature, this “support ratio” should be high for a surface to be perceived (Shipley & Kellman, 1992; Halko, Mingolla, & Somers, 2008). To confirm that a surface was likely not perceived in Experiments 5 and 6, five people (all naive to our purpose; two of whom were in Experiment 5 and/or Experiment 6) sat through several trials of Experiments 5 and 6. To illustrate the possibility of a common surface, each person was shown a mechanical device with two pieces of paper diametrically opposed and moving a circular trajectory. The pieces of paper were fixed to a rotating translucent disc that was responsible for the motion. All five people were asked if, during the Experiments 5 and 6 trials, they perceived the objects as connected to or part of a common surface. All said no.

Right hemifield advantage, particularly when tracking only one target

For Experiments 1 through 4, the stimuli were lateralized, presented either to the left or to the right hemifield. Performance was sometimes better for those trials where the target or targets were presented in the right hemifield (Figure A2).

Based on repeated-measures ANOVAs including target number, hemifield, and their interaction performed separately for each experiment, performance was significantly better in the right hemifield for Experiment 2: $F(1, 6) = 7.01, p = 0.038$ and Experiment 4: $F(1, 3) = 27.08, p = 0.014$. The effect of hemifield was not close to significance in Experiments 1 or 3, although the trend was in the same direction, an advantage for the right hemifield, Experiment 1: $F(1, 7) = 0.03, p = 0.876$; Experiment 3: $F(1, 8) = 0.15, p = 0.711$. The interaction of hemifield and number of targets was not significant for any experiment.

ANOVAs are arguably inappropriate for proportion correct, as proportion correct is distributed according to the binomial rather than the normal distribution. Therefore, the data were also fit separately for each

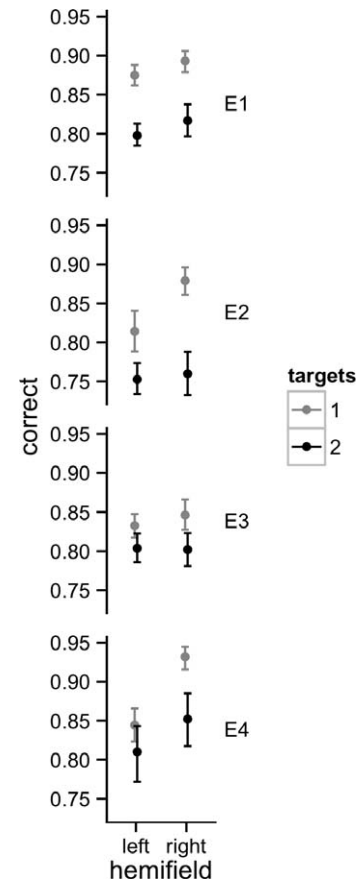

Figure A2. A right hemifield advantage is present in some experiments, particularly in the one-target condition. Error bars are 68% bootstrapped confidence intervals between subjects.

experiment by maximum likelihood to a logistic mixed model including target number, hemifield, and its interaction as fixed-effect covariate with subject a random effect covariate (“glmer” function of Bates, Maechler, Bolker, & Walker, 2013). All four experiments showed a significant target number effect, but that is not the main interest here. Based on Wald z tests of whether the coefficients are significantly different than zero, just as for the ANOVAs both Experiments 2 and 4 had a significant right hemifield advantage. Experiment 2: Wald $z = -3.80, p = 0.0001$. Experiment 4: Wald $z = -5.14, p < 0.0001$. The corresponding tests for the interaction of hemifield and target number were also significant in the case of Experiment 2, Wald $z = -7.78, p = 0.003$ and Experiment 4, Wald $z = -6.06, p < 0.001$. The nonsignificant interaction trends in Experiments 1 and 3 were in the same direction, a greater right hemifield advantage in the one-target condition.

The analyses above provide good evidence for a right hemifield advantage and some evidence that the advantage is greater for one target than for two targets. The right hemifield advantage may be explained by the theory that stimuli presented to the right hemifield benefit from processing by both hemispheres, whereas

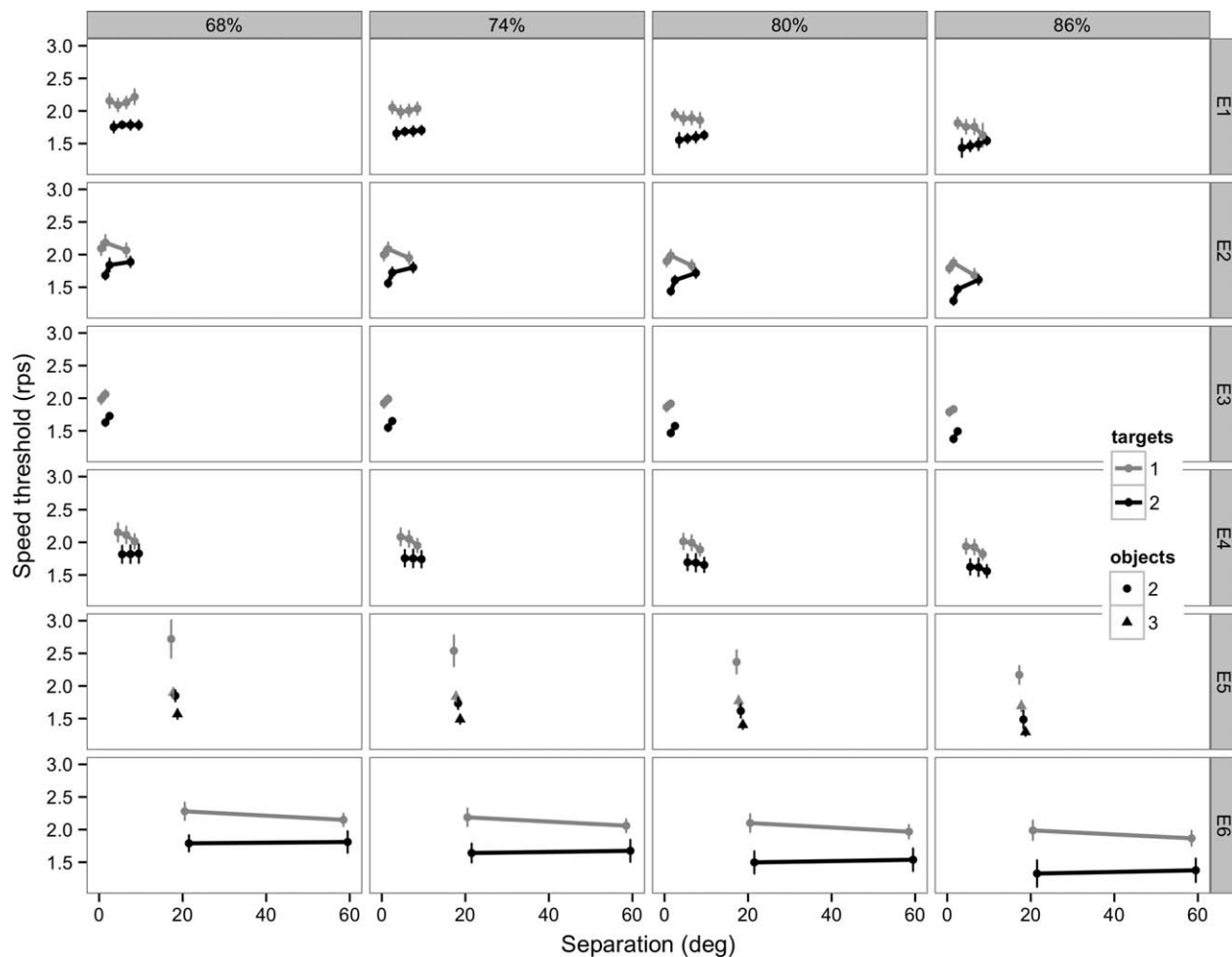

Figure A3. Speed thresholds at four different criterion levels (columns) for each experiment (rows) and separation. In Experiment 5, some participants ran a condition with two objects in the trajectory (one potential target, one distractor) as well as the condition with three objects (one potential target, two distractors). The results for the two-objects condition were not included in the main results section but are shown here. For the three-objects condition of Experiment 5, the actual criterion level is not the figure indicated at top of the column; rather, the actual level was rescaled based on the three object condition's chance rate of 33% (see Holcombe & Chen, 2013).

stimuli presented to the left hemifield are processed by only one hemisphere (Mesulam, 1999). In the case of tracking, this contradicts the claim that tracking in the two hemispheres are wholly independent (Alvarez & Cavanagh, 2005), but some results indicate that tracking is only partially independent in the two hemispheres (Holcombe & Chen, 2012; Hudson, Howe, & Little, 2012; Chen et al., 2013).

The interaction of hemifield and number of targets might be explained with the theory that the left hemisphere is better for “local attention” (Robertson, Lamb, & Knight, 1988) if the one-target condition is more an instance of local attention than is the two-target condition where a larger region must perhaps be attended. But the result appears to run contrary to findings from several tasks that hemifield differences occur more reliably under divided attention (Hübner, Volberg, & Studer, 2007), if we consider the two-target

condition an instance of divided attention and the one-target condition focused attention.

Here we have assumed that the participants kept their eyes near the fixation point, but if they did not and, moreover, broke fixation differently for the two sides, then tracking performance differences between the hemifields could be attributed to a difference in retinal eccentricity for the left- and right-hemifield presentations. As explained in the Participants subsection of the Methods, there is reason (including eyetracking in previous experiments) to believe they were good fixators, but even relatively small deviations from fixation may be enough to significantly improve performance for one or the other side. Thus future work with eyetracking would be needed to confirm the differences reported here.

Inner vs. outer ring performance (Experiment 5 and Experiment 6)

In Experiments 5 and 6, the two targets were presented in concentric rings. The outer ring was presented at a slower rotational speed because previous work documented a small effect of eccentricity on rotational speed limit (Holcombe & Chen, 2012, 2013). The purpose of this adjustment was to create roughly the same level of difficulty on the two rings, so that participants would not be discouraged and give up on tracking one of them. To assess whether this was achieved, proportion correct was analyzed with a repeated-measures ANCOVA including post-cued ring as a factor (recall that participants were asked to respond to the outer ring in half of trials and the inner ring in the other half of trials), target number, separation, and all interactions. Overall, proportion correct was 81.1% for the inner ring and 81.3% for the outer ring, not significantly different ($p = 0.928$).

The ANCOVA also included interaction terms. These were of less interest than the primary issue of the main effect of ring, and included the interactions of ring with separation and target number, which were not significant. In Experiment 6, however, the three-way interaction of separation, target number, and postcued ring was significant, $F(1, 7) = 16.15$, $p = 0.005$. Because analyzing proportion correct with an ANCOVA is questionable due to the assumption of normality, these data were also fitted via maximum likelihood with a logistic mixed-effect model (Bates et al., 2013) with the same factors and interactions included as fixed effects, and subject as a random effect. For Experiment 6 the three-way interaction was again significant, according to Wald $z = 2.64$, $p = 0.008$.

Interpreting higher-order interactions is often difficult. The trends underlying the interaction are that outer ring performance is facilitated by separation in the two-target condition, but for all other conditions, separation impairs performance. For example, performance for the inner ring declines with separation, while performance for the outer ring increases with separation (for the two-target condition). It's hard to know the reason for this, particularly because the poorer performance for the outer ring in the large separation condition does not necessarily correspond to greater difficulty tracking it. Instead it could be caused by variation in proportion of the tracking resource allocated to the two targets. This proportion is under voluntary control to some degree (Chen et al., 2013), and it may change when participants “give up on” a target after a quick assessment of whether it is too fast to track, then shifting all their resource to the other target. This may distort any intrinsic difference in difficulty across the rings in the two-target condition.

Speed thresholds at various performance levels

The Results section showed only the speed thresholds at the 80% performance level. Figure A3 shows the speed thresholds for the six experiments at each of four performance levels. The pattern of thresholds is broadly similar across the performance levels. There is some evidence, however, that the unexpected decrease with separation in performance of the one-target condition in Experiment 1 is larger at the higher performance levels.