

Anomaly pre-localization in distribution–transmission mains by pump trip: preliminary field tests in the Milan pipe system

S. Meniconi, B. Brunone, M. Ferrante, C. Capponi, C. A. Carrettini, C. Chiesa, D. Segalini and E. A. Lanfranchi

ABSTRACT

In this paper, the reliability of transients due to pump trip as a powerful tool for the pre-localization of anomalies in real pipe systems is tested. The examined pipe system is part of the one supplying the city of Milan, Italy and is managed by Metropolitana Milanese SpA (MM). The characteristics of such a system can be considered as intermediate between those of classical transmission mains and distribution systems because of its several branches. A Lagrangian model simulating pressure wave propagation is used to evaluate the pipe pressure wave speed – associated with a genetic algorithm – and to locate possible anomalies – associated with wavelet analysis. The results of the diagnosis of the pipe system are corroborated by repairs executed by MM in the area where possible anomalies have been pre-localized.

Key words | genetic algorithm, Lagrangian model, pipe diagnosis, transient tests, transmission–distribution pipe system, wavelet transform

S. Meniconi (corresponding author)

B. Brunone

M. Ferrante

C. Capponi

Dipartimento di Ingegneria Civile ed Ambientale,
The University of Perugia,
Via G. Duranti 93,
06125 Perugia,
Italy

E-mail: silvia.meniconi@unipg.it

C. A. Carrettini

C. Chiesa

D. Segalini

E. A. Lanfranchi

Metropolitana Milanese S.p.A.,
Via del Vecchio Politecnico 8,
20121 Milano,
Italy

INTRODUCTION

Traditional design guidelines for the analysis of transients due to the variation of functioning conditions in pressurized pipe systems contemplated the evaluation of all reasonably possible combinations of loads to check system strength. Moreover, transient effects were considered as a possible cause of accidents only in transmission mains (TM) where large overpressures could be due, as an example, to the closing of control valves or pump trip. In contrast, in water distribution systems (WDS) transient effects were not assumed as a possible cause of pipe failure since the numerous branches and user's taps behaved as a sort of natural protection device against pressure waves. In other words, vulnerability of TM is due to the fact that such systems are closed systems from the pressure wave propagation point of view whereas WDS, as open systems, eject most pressure waves. This, of course, is not generally true: for example, leaks, as an external flow, may reduce significantly the effects of a given

transient in a TM as well as pressure waves do not damp in the parts of WDS with a small demand. In the last couple of decades, such an approach to transient analysis in pressurized pipe systems has changed radically from several points of view (Boulos *et al.* 2005). First, as will be discussed in more detail later, pressure waves are used as a tool to check TM condition. Second, in WDS transient events can have significant water quality and health implications as well as cause background leakage due to the fatigue of joints. Third, TM has evolved towards more complex topologies – with several branches and connections – to ensure the necessary flexibility of functioning conditions.

Even if properties of pressure waves partially reflected by any anomaly – as an example, leaks, partially closed in-line valves, partial blockages – have been known for a long time (e.g. Babbitt 1920; Contractor 1965), attention of researchers has been captured by transient test-based

techniques (TTBT) only recently. Convincing experimental results have been obtained in the laboratory showing the effect on pressure signals of leaks (e.g. Liou 1998; Brunone & Ferrante 2001; Mpesha *et al.* 2001; Kim 2005; Lee *et al.* 2005), partially closed in-line valves (e.g. Wang *et al.* 2005; Lee *et al.* 2008; Sattar *et al.* 2008; Meniconi *et al.* 2011a, 2012b), partial blockages (e.g. Brunone *et al.* 2008a; Duan *et al.* 2012; Meniconi *et al.* 2012a), illegal branches (Meniconi *et al.* 2011c), and internal wall condition (e.g. Stephens *et al.* 2013; Gong *et al.* 2013, 2014). This body of experiments demonstrates the actual possibility of locating and sizing anomalies via comparison of the pressure signal that would be observed in the corresponding anomaly-free system. Refining techniques of analysis of pressure signals, strength and defects of possible approaches – time domain (e.g. Jonsson & Larson 1992; Brunone 1999), frequency domain (e.g. Mpesha *et al.* 2002; Lee *et al.* 2007, 2008, 2013; Lee & Vitkovsky 2010; Ghazali *et al.* 2012), time and frequency domain coupled (Meniconi *et al.* 2013), and wavelet analysis (e.g. Stoianov *et al.* 2001; Al-Shidhani *et al.* 2003; Ferrante *et al.* 2009b; Hachem & Schleiss 2012) – are discussed in the literature. Attention has also been devoted to devices to generate proper pressure waves beyond the closure of a valve or pump trip according to the characteristics of the examined system (e.g. Brunone *et al.* 2008b; Taghvaei *et al.* 2010; Stephens *et al.* 2011). TTBT have also been checked, with quite good results, on more complex laboratory pipe systems (e.g. Mohapatra *et al.* 2006; Ferrante *et al.* 2009a; Covas & Ramos 2010; Soares *et al.* 2011; Duan *et al.* 2011), as well as in real TM (e.g. Meniconi *et al.* 2011b; Stephens *et al.* 2011; Ghazali *et al.* 2012). In such a context of intense research activity, TTBT for WDS can be considered a quite unexplored and extremely challenging ‘area’ because of the complexity of such systems. In fact, it is evident that, since at any connection of WDS propagating pressure waves are partially reflected and transmitted, they vanish very soon unless very particular boundary conditions occur (e.g. all taps and branches closed). Moreover, for a given arrival time of a pressure wave at a measurement section, several paths can be assumed – because of, as an example, the closed loops – and then the uniqueness of the solution in terms of anomaly pre-localization is not ensured unless several measurement sections are activated.

This paper concerns the use of TTBT in a part of a real pipe system in the city of Milan (Italy), managed by Metropolitana Milanese SpA (MM), whose characteristics can be considered as intermediate between those of classical TM and WDS because of its several branches. Pressure waves exploring the system are generated by a pump trip. A Lagrangian model (LM) simulating pressure wave propagation is used to evaluate pressure wave speed of pipes – associated with a genetic algorithm (GA) – and to locate possible anomalies – associated with wavelet analysis. The results of the diagnosis of the pipe system are corroborated by repairs executed by MM in the area where possible anomalies have been detected. Limitations of the proposed methodology in WDS as well as possible improvements are discussed in the conclusions. This paper is an extension of the one presented at the 12th edition of the International Conference on ‘Computing and Control for the Water Industry – CCWI2013’ (Brunone *et al.* 2014).

INVESTIGATED PIPE SYSTEM

Field tests are executed in a part of the WDS of Milan, Italy, managed by MM (Figure 1). All supplied water is pumped from the aquifers by 29 pumping stations. Each pumping station supplies a part of the Milan WDS, with some users very close to it. As a consequence, the rising mains cannot be considered as a classical TM because of the numerous branches connected to them.

The examined steel pipe system is supplied by the Novara pumping station (Figure 2). The four pumps convey water from the tanks into the system at a rated capacity of 400 L/s each; the check valves are installed immediately downstream of the pumping group. The complexity of the system is clearly shown in Figure 3 where the main pipe is highlighted by a bold line and the main connections as well as the pumping station node are numbered. For the sake of clarity, in Figure 4 and Table 1, the principal characteristics of the main pipe are indicated, with L and DN being the pipe length and nominal diameter, respectively. It can be observed that the nominal diameter is DN800 (with the exception of the first 27.5 m), and junctions 4 and 7 connect the main pipe to dead ends by

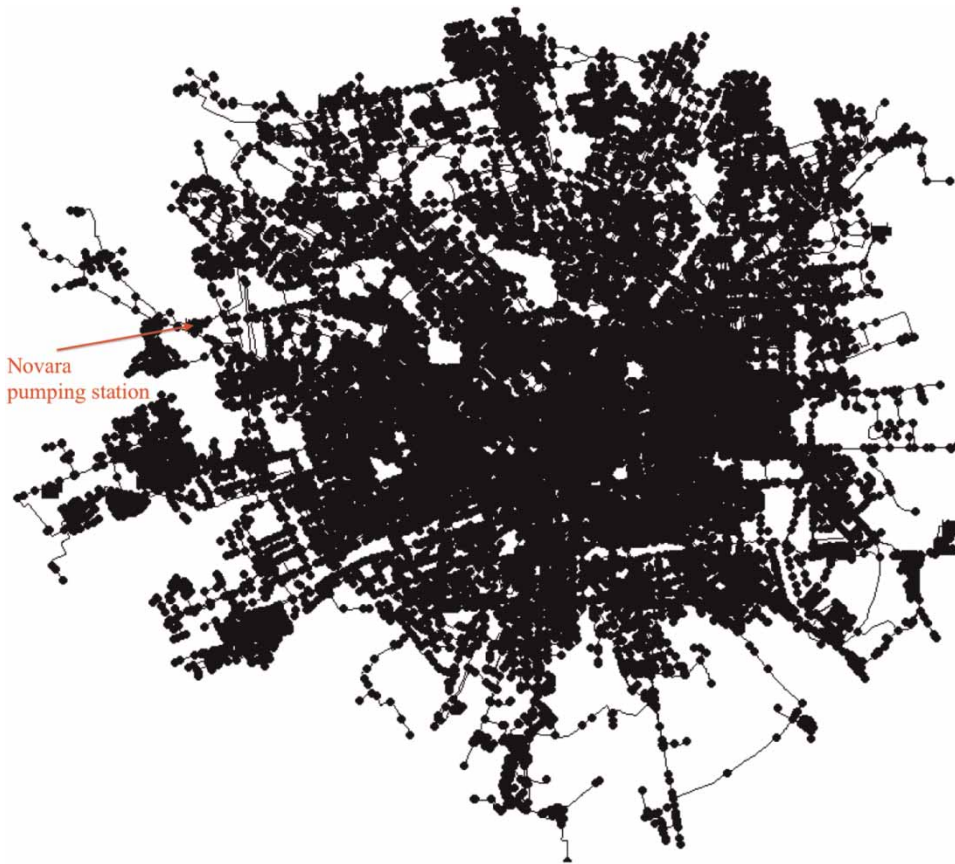

Figure 1 | Milan water pipe system with the Novara pumping station highlighted.



Figure 2 | Novara pumping station: (a) the pipe inside the station; (b) the pumps.

means of very short pipes (i.e., 3.2 m and 0.4 m, respectively).

During tests, only one of the four pumps is functioning and pressure signal is measured immediately downstream of the check valve by means of piezoresistive transducers.

The measurement uncertainty of such probes is rated at $\pm 0.15\%$ of the full scale and the time response is about 1 ms; the pressures are sampled at a frequency of 1,000 Hz. Two transient tests, generated by abruptly stopping the electricity supply (pump trip) have been carried



Figure 3 | The part of Milan WDS examined by means of TTB.

out. The main difference between such tests concerns the number of active connections to the main pipe. During test no. 1, all branches are active (Figure 4(a)), whereas during test no. 2, some of the connections closest to the pumping station are closed: the DN500 pipe, connected to the main pipe at junction 2 and DN300 valve immediately downstream of node 6 (Figure 4(b)). The second difference is the full-range scale of the used pressure transducer that has been refined according to the measured maximum pressure (test no. 1: full scale = 100 m; test no. 2: full scale = 70 m). The pressure signals, H_E , acquired during tests no. 1 and no. 2 are reported in Figure 5 by a dashed line and a continuous line, respectively (the maneuver begins at $t = 0$, and the subscript E indicates the experimental data).

METHODS

Each step of the proposed methodology is reported in the flow chart in Figure 6. A preliminary network survey allows evaluation of the pressure wave speed, α , of all pipes of the system on the basis of their geometrical and mechanical characteristics. A different procedure is used to obtain more reliable values of α , for the pipes closest to the measurement section and the others, respectively. The first ones are given by the analysis of H_E by the wavelet transform (WT), which allows singularities to be detected (Mallat & Zhong 1992; Mallat & Hwang 1992; Ferrante *et al.* 2009b); for pipes installed at a larger distance an ad hoc optimization procedure has been followed, based on a micro GA. In both cases, a LM is run to capture the main characteristics of the pressure signal and evaluate

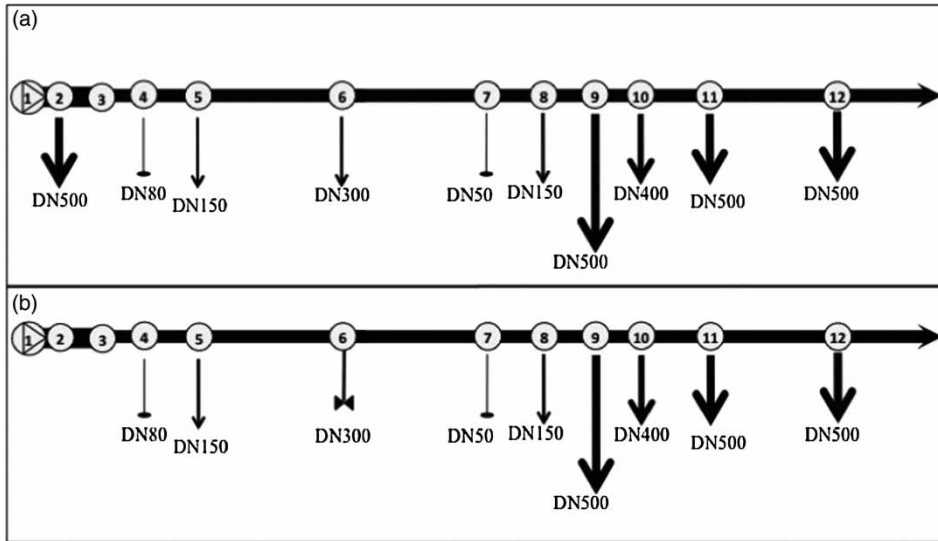

Figure 4 | Schematic of the examined system: (a) test no. 1; (b) test no. 2 (during such a test, the DN500 and DN300 pipes connected to the main pipe at junctions 2 and 6, respectively, have been temporarily closed).

Table 1 | Principal characteristics of the examined pipe system (1: pumping station)

Initial node	End node	L (m)	DN (mm)
1	2	13	900
2	3	14.5	900
3	4	260.5	800
4	5	310	800
5	6	1,759.6	800
6	7	1,458	800
7	8	771	800
8	9	171.7	800
9	10	107.4	800
10	11	446.3	800
11	12	989.4	800

the causes of its discontinuities. Such a model is based on the solution of the differential equations governing frictionless transients in pressurized pipe systems (Swaffield & Boldy 1993) and assumes an instantaneous maneuver. The LM follows the wave generated by the maneuver and its interactions with the successive discontinuities (i.e., junctions, leaks, partially closed in-line valves, etc.); it records the paths of the reflected and transmitted pressure waves and their arrival times at any node. Specifically, the LM identifies which waves pass the measurement section and calculates the instants of passage. Such time instants are compared with

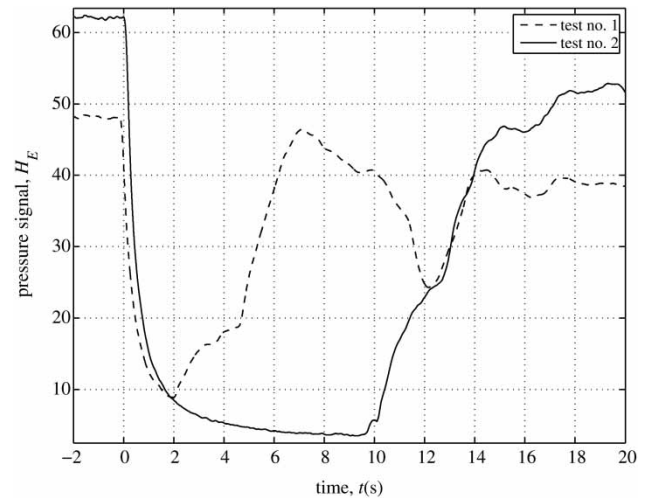

Figure 5 | Experimental pressure signal, H_E , during test no. 1 (Figure 4(a) pipe system) and test no. 2 (Figure 4(b) pipe system).

those indicated by the WT for each singularity. In fact, the WT chains expose singularities in the pressure signal and then allow identification of the passage of waves through the measurement section. Possible anomalies correspond to the instants of time highlighted by the WT but not by the LM. In such a context, the assumption of DN as internal diameter in the LM simulation does not invalidate the results. The evaluation of the entity of such anomalies by means of the LM is not reliable because of the omission of the friction term – both the steady and unsteady component (Pezzinga 1999;

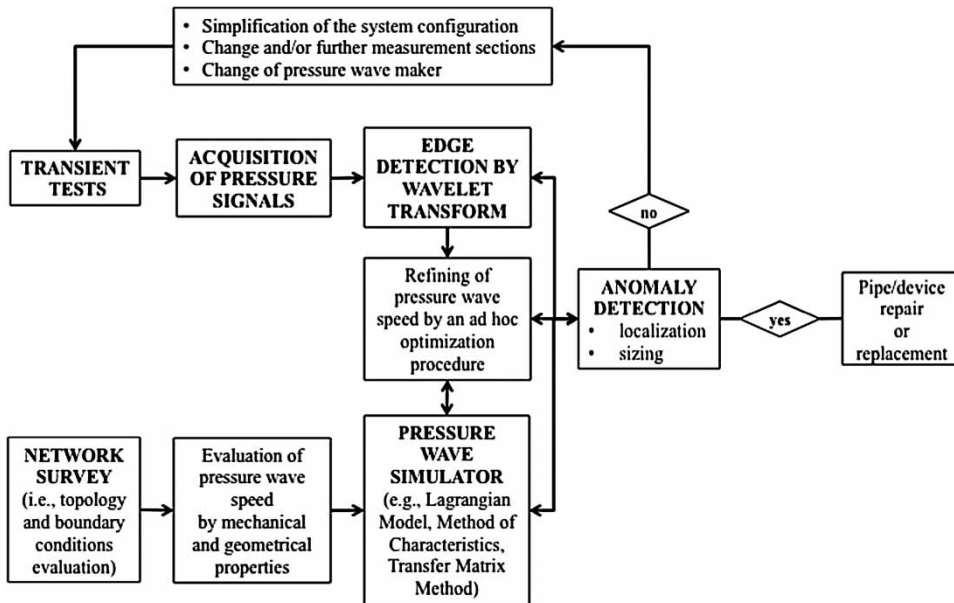

Figure 6 | Flow chart of the procedure for the pipe system diagnosis by means of transient tests with possible options.

Brunone & Berni 2010) – as well as the assumed instantaneity of the maneuver. The sizing of the anomalies indicated by the LM is possible only after a more sophisticated calibration of more complex numerical models: the Method of Characteristics (Wylie & Streeter 1993), the Impedance Method (Fox 1989; Wylie & Streeter 1993), and the Transfer Matrix Method (Chaudhry 1970, 2013). It is worth noting that a classical Inverse Transient Analysis is beyond the scope of this paper, one of the first attempts of using TTBT in a complex pipe system, which is inevitably focused only on the pre-localization of the anomalies. According to the procedure shown in Figure 6, some improvements in the diagnosis of the system can be obtained by simplifying its configuration (e.g. by closing some branches), adding further measurement sections, as well as, if possible, installing a different transient generator (Brunone et al. 2008b; Taghvaei et al. 2010; Stephens et al. 2011).

RESULTS

Test no. 1

For each discontinuity in H_E (Figure 7(a)), the WT presents a chain of maxima local moduli, indicated by a dash-dotted

line in Figure 7(b). The numerical simulation of pressure wave propagation by means of the LM has been carried out not for the entire Milan WDS but for the part reasonably supplied by the Novara pumping station. In such a context, node 12 (Figure 3) has been chosen as the outmost downstream node. As a first attempt, in the simulation, the pressure wave speed is set constant and equal to 1,000 m/s with such a value being compatible with pipe material and geometrical characteristics. Moreover, to emphasize the response of the system to the transients, all terminals are set closed. In Figure 7(c) the impulse response function carried out by the LM is shown, with $\Delta H_N = H_N - H_{N,0}$, and the subscripts N and 0 indicating the numerical result and initial value, respectively. It is evident that many discontinuities of the experimental pressure signal pointed out by the WT do not correspond to impulses in the LM. The inaccuracy of the LM can be ascribed to various factors. First, since the maneuver is really slow and there are several open junctions very close to the pumping station, there is a combined effect on the pressure signal of the maneuver itself and such junctions. Consequently, since the exact efflux curve of the pump is not known, it is difficult to distinguish the effect of the maneuver from that of the junctions as will be confirmed by test no. 2 results. Second, there is no further section in the proximity

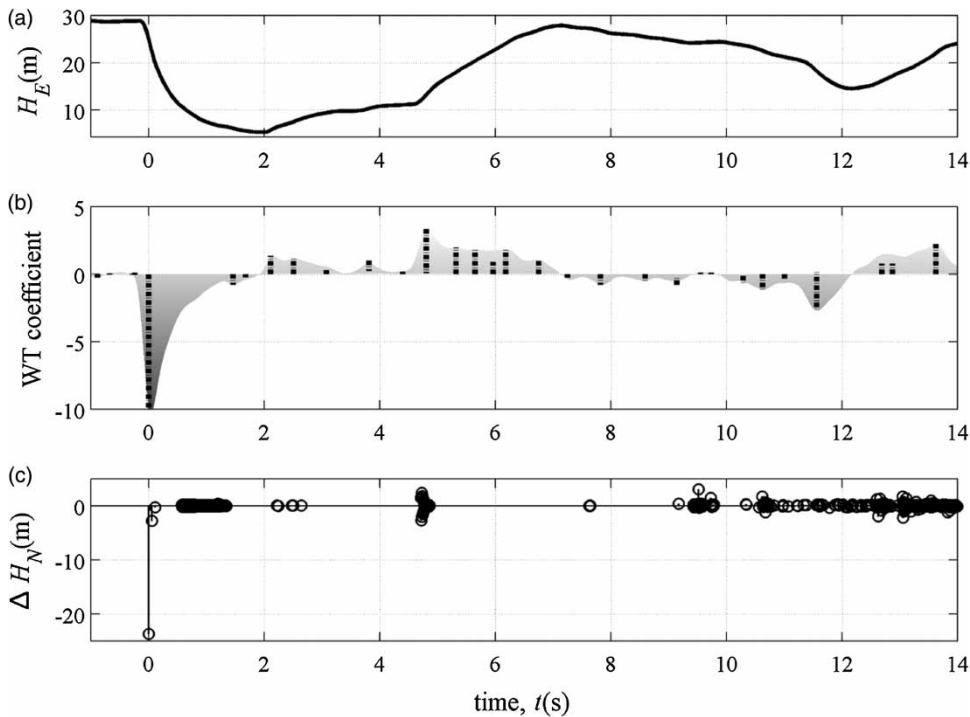

Figure 7 | Test no. 1: (a) experimental pressure signal, H_E ; (b) time history of wavelet coefficients (in gray) and relative chains of local extreme values (dash-dotted black lines); (c) impulse response function carried out by the LM in the case all terminals are closed.

of the measurement section suitable for evaluating the pressure wave speed. Moreover, during the test, the full scale of the pressure transducer ($=100$ m) is too large with respect to the acquired maximum value of the pressure ($=53$ m). Thus, according to Figure 6, a different transient test has been executed. Since the maneuver cannot be modified, as a feasible action, some of the connections closest to the pumping station have been closed, according to MM service constraints.

Test no. 2

During test no. 2, connections 2 and 6 are closed (Figure 4(b)). As is predictable, the steady-state pressure is higher than during test no. 1 (Figure 5, continuous line). Even if the maneuver giving rise to the transient is the same, during test no. 2 it seems longer, because some of the singularities which hid it have been ‘removed’. Due to such a simplification of the system, the WT can then be used to evaluate the pressure wave speed of the main pipe, as well as the other pressure wave speeds which can be

determined by means of an optimization procedure. First of all, a skeletonization of the network is operated for the LM. Second, the LM and GA are coupled considering such a skeletonized system. Finally, the optimal values of the pressure wave speeds are obtained by minimizing the difference between the numerical and experimental pressure signals.

Evaluation of the pressure wave speeds

In Figure 8(b) the results of the WT of the pressure signal are shown. After the end of the maneuver, the first clear singularity evidenced by the WT – a 2.2 m pressure rise – is at $t = 9.61$ s. Since at this time the check valve is completely closed, it behaves as a dead end and then such an increment is about double with respect to the pressure wave that caused it. Such a wave can be ascribed presumably to junction 8 at a distance of about 4,587 m from the measurement section. In fact, within the Allievi-Joukowski theory this junction would cause an increase in the pressure signal of 2.02 m at the check valve. By associating

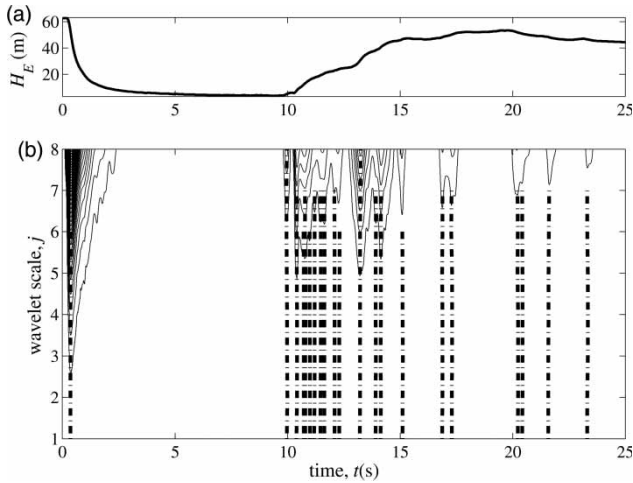

Figure 8 | Test no. 2: (a) experimental pressure signal, H_E ; (b) relative WT.

such a discontinuity of the pressure signal with junction 8, the resulting value of the pressure wave speed of the main pipe is equal to 954.26 m/s, which is compatible with its characteristics. In order to evaluate the other pressure wave speeds, an optimization procedure is developed that comprises: (i) skeletonizing the system, (ii) coupling a GA and the LM, and (iii) final refining of pressure wave speeds. The skeletonization is the process of representing a WDS by selecting only the ‘most important’ pipes from the pressure wave propagation point of view. Then, a different approach has to be followed with respect to the skeletonization executed to analyze a system in steady-state conditions. In fact, the analysis of the simulated pressure waves allows selection of the most important pipes, i.e., those crossed by the largest pressure waves. For the examined system, in the first phase the LM is run by considering the entire network with all pipes with the same pressure wave speed (=954.26 m/s) and all terminals closed. Simulation stops at $t = 13.21$ s which is the time when the first pressure wave reflected by the outmost junction 12 reaches the measurement section. The resulting skeletonized system includes 31 pipes with a maximum distance of 6,303 m from the measurement section and the diameter ranging from 0.05 to 0.9 m. In such pipes, pressure waves with an absolute amplitude larger than about 33.8 m occur, with the maximum pressure variation being 54.5 m. The values of the pressure wave speed of such pipes, except the main one, derive from an

optimization technique which minimizes the difference between H_N and H_E . Within the LM approach, this means that the better the agreement, the better the evaluation of pressure wave travel time and then α . In the optimization process, the Nash–Sutcliffe model efficiency coefficient, E_f , is used:

$$E_f = 1 - \sum_{i=1, i>T}^M \frac{(H_{E,i} - H_{N,i})^2}{(H_{E,i} - \bar{H}_E)^2} \quad (1)$$

with M = number of samples after the end of the maneuver, and T = maneuver duration. E_f can range from $-\infty$ to 1: an efficiency of 1 corresponds to a perfect match of modeled pressure signal to the experimental data, whereas $E_f = 0$ indicates that the model test is as accurate as the mean of the experimental data. An efficiency less than zero occurs when the residual variance is larger than the data variance. The optimal values of the pressure wave speeds for each value of pipe diameter in the skeletonized network have been determined by a novel heuristic procedure carried out by the Genetic Toolbox of MATLAB® (Goldberg 1989). The GA has been carried out for 40 generations with a population composed of 20 individuals with a crossover percentage equal to 0.8. The corresponding value of E_f is 0.9873 and the values of pressure wave speed vs. pipe diameter are reported in Figure 9(a). In such a figure it can be observed that some values of the pressure wave speeds are not suitable

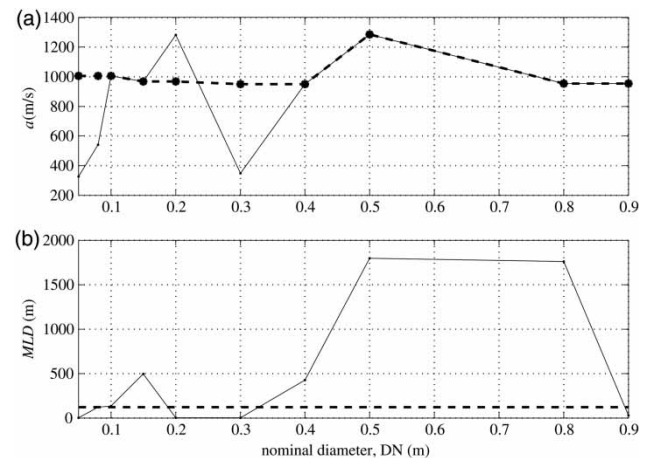

Figure 9 | Test no. 2: (a) pressure wave speed, α , vs. DN; (b) pipe maximum length, MLD, vs. DN.

with respect to pipe characteristics. Such unacceptable values of α are due to the shortness of some branches, whose characteristic time is too small with respect to the dynamics of the experimental pressure signals. To pinpoint values more compatible to pipe characteristics, the optimization procedure has been continued and the maximum length of pipe, MLD , for each value of DN in the skeletonized network has been calculated (Figure 9(b)). For example, in the case of the pipes with DN50, MLD is equal to 0.37 m. The pipe with this length is very close to the pumping station and one of its nodes is a dead end; consequently, it has an important effect on the pressure signal because it causes a large pressure wave. However, it is very short and then the pressure wave speed given by GA does not have a physical meaning. Since in the examined part of the network there are not longer branches with DN50, the value of α of pipes with DN100 is assigned to the pipes with DN50. Summarizing, the pressure wave speed of pipes with a MLD less than 2.5% of the total pipe length, is changed with the value of α of the pipes with the closer diameter; in Figure 9(a), the assigned value of the pressure wave speed is shown with a dashed line.

DISCUSSION

To associate more efficiently pressure discontinuities (which cause chains of extreme values of the WT) with network singularities (which determine pressure waves in the LM) the impulse response function carried out by the LM is compared with the WT coefficients. The experimental pressure signal and the related time-history of wavelet coefficients are reported in Figures 10(a) and 10(b), respectively. In Figure 10(b), the chains of local extreme values of wavelet coefficients are indicated by black dash-dotted lines. Moreover, the impulse response function of the LM is shown in Figure 10(c), in the case where all terminals are closed. To better analyze the WT results and compare them with numerical data, in Figure 11 the time interval in Figure 10 from 9.5 to 13.21 s is evidenced. The WT identifies three discontinuities in the pressure signal at the instants 9.61, 9.97, and 10.2 s (Figure 11(b)). By means of the LM such discontinuities can be ascribed to the wave reflected by nodes 8, 9, and 10, respectively (Figure 11(c)). However, in the WT the first chain of extreme values that cannot be associated with any wave in the LM happens at $t = 10.4$ s (Figure 11(c)). Such a discontinuity determines a large value of the wavelet

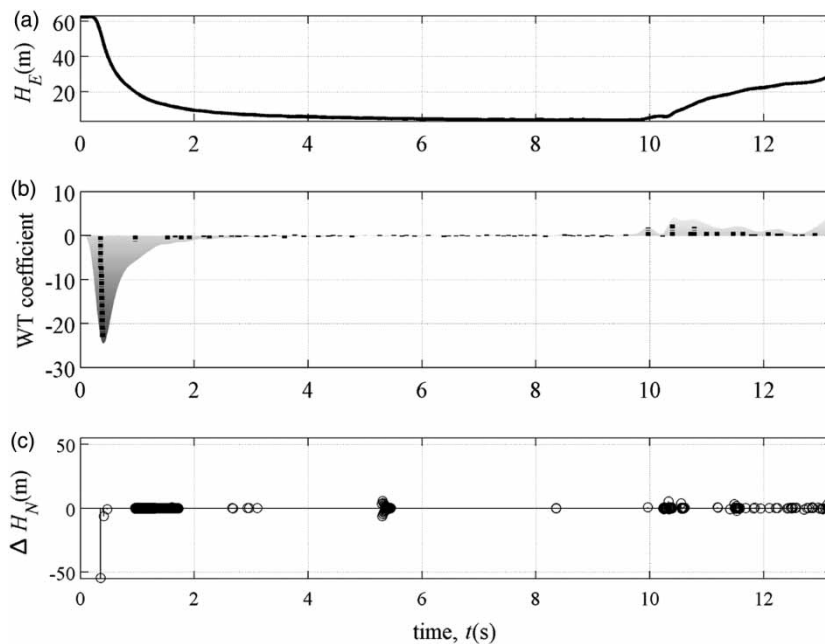

Figure 10 | Test no. 2: (a) experimental pressure signal, H_E ; (b) time history of wavelet coefficients (in gray) and relative chains of local extreme values (dash-dotted black lines); (c) impulse response function carried out by the LM in the case all terminals are closed.

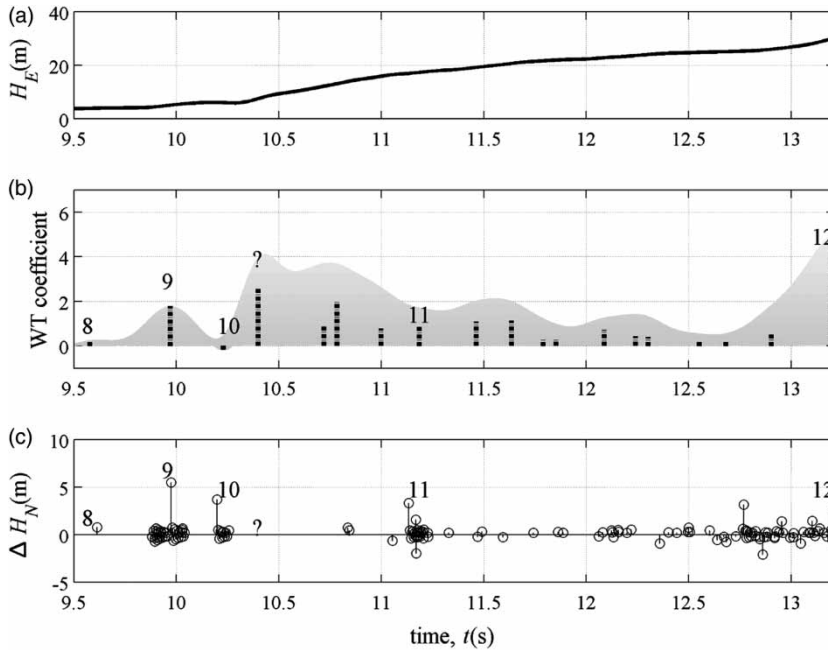

Figure 11 | Test no. 2: (a) experimental pressure signal, H_E ; (b) time history of wavelet coefficients (in gray) and relative chains of local extreme values (dash-dotted black lines); (c) impulse response function carried out by the LM in the case all terminals are closed in the time interval $9.5 \text{ s} \leq t \leq 13.21 \text{ s}$.

coefficients (=4 at the highest scale) if compared with the WT coefficients related to the discontinuity due to junction 9 (=1.9 at the highest scale). Owing to the characteristics of such a discontinuity, it could be due to: an unknown increase of pipe diameter or change of pipe material, presence of a junction or a leak. According to the pipe system characteristics, the possible locations of such an anomaly are six. As can be seen in Figure 12, where such locations are indicated by circles, the area to be investigated concerns a total length equal to 816 m. It is worth noting that such an area is placed at a distance of about 4,960 m from the unique measurement section. The question – i.e., where the real anomaly is located – has been settled by MM, who repaired some leaks in one of the locations evidenced in Figure 12(b), after the transient test. Even if some precautions are needed, this result can be considered as quite good bearing in mind the following circumstances: the complexity of the investigated pipe systems, the extreme exiguous set of measured data with just one pressure probe installed and, maybe most importantly, the inadequacy of the maneuver generating the pressure waves. Furthermore, it has to be pointed out that in a much more controlled and equipped ‘environment’ – the Water-Wise@SG live tests in Singapore (Allen

et al. 2011) – a simulated burst has been localized with an error of 45 m.

CONCLUSIONS

In this paper the possibility of using transients to check the performance of a complex transmission–distribution system is explored. As indicated in Figure 6, in the proposed procedure, the pressure signal acquired at one measurement section is preliminarily analyzed by means of the WT to locate the main singularities and the pressure wave speeds of the main pipes. Then, a LM is carried out in order to evaluate the causes of experimental pressure waves.

The proposed procedure is applied to a northwest part of Milan WDS supplied by the Novara pumping station. Transients are generated by a pump trip. A preliminary test is carried out to analyze the characteristics of the maneuver and the system. Then, a further test is executed on a simplified system and the acquired pressure signal is analyzed by the WT, which allows evaluation of the main pipe pressure wave speed. In order to calculate the other

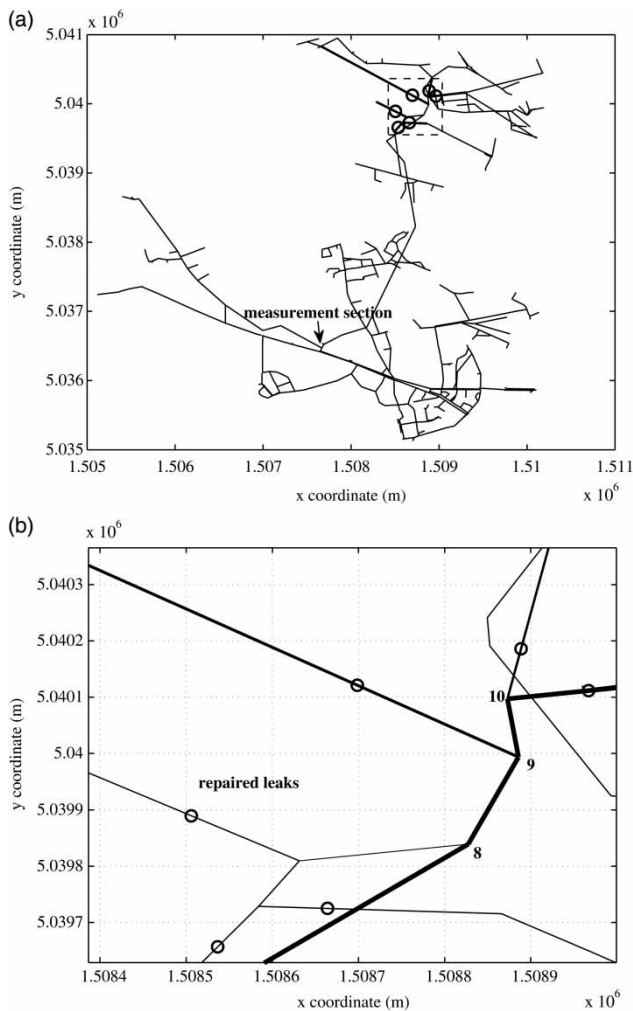

Figure 12 | (a) The system supplied by Novara pumping station with the location of the measurement section and the district with the possible anomalies (highlighted by circles); (b) magnified image of the district with indication of the leaks repaired by MM after the transient tests.

wave speeds, an ad hoc optimization procedure is developed by skeletonizing the system and then coupling the LM and a GA.

By comparing the numerical impulse response function and the results of the WT, a possible anomaly, i.e., a singularity in the pressure signal that does not correspond to an impulse in the LM, is detected. However, because of the complexity of the investigated system, and the use of just one measurement section, the possible location of such an anomaly is not unique. The presence of some leaks in one of the locations highlighted by the procedure has been confirmed by MM. Further improvements in the diagnosis

reliability are expected by increasing the number of measurement sections.

ACKNOWLEDGEMENTS

This research has been supported in part by the Italian Ministry of Education, University and Research (MIUR) – under the Projects of Relevant National Interest ‘Advanced analysis tools for the management of water losses in urban aqueducts’, ‘Tools and procedures for an advanced and sustainable management of WDS’ – and Fondazione Cassa Risparmio Perugia under the project ‘Hydraulic characterization of innovative pipe materials (no. 2013.0050.021)’.

REFERENCES

- Allen, M., Preis, A., Iobal, M., Srirangarajan, S., Lim, H., Girod, L. & Whittle, A. 2011 Real-time in-network distribution system monitoring to improve operational efficiency. *J. AWWA* **103** (7), 63–75.
- Al-Shidhani, I., Beck, S. & Staszewsky, W. 2003 *Leak monitoring in pipeline networks using wavelet analysis*. *Key Eng. Mater.* **245** (2), 51–58.
- Babbitt, H. E. 1920 The detection of leaks in underground pipes. *J. AWWA* **7** (4), 589–595.
- Boulos, P. F., Karney, B. W., Wood, D. J. & Lingireddy, S. 2005 Hydraulic transient guidelines for protecting water distribution systems. *J. AWWA* **97** (5), 111–124.
- Brunone, B. 1999 *Transient test-based technique for leak detection in outfall pipes*. *J. Water Res. Plan. Manage.* **125** (5), 302–306.
- Brunone, B. & Berni, A. 2010 *Wall shear stress in transient turbulent pipe flow by local velocity measurement*. *J. Hydraul. Eng.* **136** (10), 716–726.
- Brunone, B. & Ferrante, M. 2001 *Detecting leaks in pressurised pipes by means of transients*. *J. Hydraul. Res.* **39** (5), 539–547.
- Brunone, B., Ferrante, M. & Meniconi, S. 2008a *Discussion of ‘Detection of partial blockage in single pipelines’ by PK Mohapatra, MH Chaudhry, AA Kassem, and J Moloo*. *J. Hydraul. Eng.* **134** (6), 872–874.
- Brunone, B., Ferrante, M. & Meniconi, S. 2008b *Portable pressure wave-maker for leak detection and pipe system characterization*. *J. AWWA* **100** (4), 108–116.
- Brunone, B., Meniconi, S., Ferrante, M., Carretini, C., Chiesa, C., Capponi, C. & Segalini, D. 2014 *The characterization of Milan WDS by pumping switching off: field test assessment*. *Procedia Eng.* **70**, 201–208.
- Chaudhry, M. H. 1970 *Resonance in pressurized piping systems*. *J. Hydraul. Div.* **96**, 1819–1839.

- Chaudhry, M. H. 2013 *Applied Hydraulic Transients*. Springer-Verlag, London, UK.
- Contractor, D. 1965 The reflection of waterhammer pressure waves from minor losses. *J. Basic Eng.* **87** (2), 445–451.
- Covas, D. & Ramos, H. 2010 Case studies of leak detection and location in water pipe systems by inverse transient analysis. *J. Water Res. Plann. Manage.* **136** (2), 248–257.
- Duan, H.-F., Lee, P., Ghidaoui, M. & Tung, Y. 2011 Leak detection in complex series pipelines by using system frequency response method. *J. Hydraul. Res.* **49** (2), 213–221.
- Duan, H.-F., Lee, P., Ghidaoui, M. & Tung, Y. 2012 Extended blockage detection in pipelines by using the system frequency response analysis. *J. Water Res. Plan. Manage.* **138** (1), 55–62.
- Ferrante, M., Brunone, B. & Meniconi, S. 2009a Leak detection in branched pipe systems coupling wavelet analysis and a lagrangian model. *J. Water Supply: Res. Technol. – AQUA* **58** (2), 95–106.
- Ferrante, M., Brunone, B. & Meniconi, S. 2009b Leak-edge detection. *J. Hydraul. Res.* **47** (2), 233–241.
- Fox, J. 1989 *Transient Flow in Pipes, Open Channels and Sewers*. Ellis Horwood, Chichester, UK.
- Ghazali, M., Beck, S., Shucksmith, J., Boxall, J. & Staszewski, W. 2012 Comparative study of instantaneous frequency based methods for leak detection in pipeline networks. *Mech. Syst. Signal Process.* **29**, 187–200.
- Goldberg, D. 1989 *Genetic Algorithms in Search, Optimization and Machine Learning*. Addison-Wesley Professional, Reading, MA.
- Gong, J., Simpson, A., Lambert, M., Zecchin, A., Kim, Y. & Tijsseling, A. 2013 Detection of distributed deterioration in single pipes using transient reflections. *J. Pipeline Syst. Eng. Prac.* **4** (1), 32–40.
- Gong, J., Lambert, M. F., Simpson, A. R. & Zecchin, A. C. 2014 Detection of localized deterioration distributed along single pipelines by reconstructive MOC analysis. *J. Hydraul. Eng.* **140** (2), 190–198.
- Hachem, F. E. & Schleiss, A. J. 2012 Detection of local wall stiffness drop in steel-lined pressure tunnels and shafts of hydroelectric power plants using steep pressure wave excitation and wavelet decomposition. *J. Hydraul. Eng.* **138** (1), 35–45.
- Jonsson, L. & Larson, M. 1992 Leak detection through hydraulic transient analysis. In: *Proceedings of International Conference on 'Pipeline Systems'*, Manchester, UK, pp. 273–286.
- Kim, S. H. 2005 Extensive development of leak detection algorithm by impulse response method. *J. Hydraul. Eng.* **131** (3), 201–208.
- Lee, P. J. & Vitkovsky, J. P. 2010 Quantifying linearization error when modeling fluid pipeline transients using the frequency response method. *J. Hydraul. Eng.* **136** (10), 831–836.
- Lee, P. J., Vitkovsky, J. P., Lambert, M. F., Simpson, A. R. & Liggett, J. A. 2005 Frequency domain analysis for detecting pipeline leaks. *J. Hydraul. Eng.* **131** (7), 596–604.
- Lee, P. J., Vitovsky, J. P., Lambert, M. F., Simpson, A. R. & Liggett, J. 2007 Leak location in pipelines using the impulse response function. *J. Hydraul. Res.* **45** (5), 643–652.
- Lee, P. J., Vitkovsky, J. P., Lambert, M. F., Simpson, A. R. & Liggett, J. A. 2008 Discrete blockage detection in pipelines using the frequency response diagram: numerical study. *J. Hydraul. Eng.* **134** (5), 658–663.
- Lee, P. J., Duan, H. F., Vitkovsky, J. P. & Zecchin, A. 2013 The effect of time-frequency discretization on the accuracy of the transmission line modelling of fluid transients. *J. Hydraul. Res.* **51** (3), 273–283.
- Liou, C. P. 1998 Pipeline leak detection by impulse response extraction. *J. Fluids Eng.* **120**, 833–838.
- Mallat, S. & Hwang, W. 1992 Singularity detection and processing with wavelets. *IEEE Trans. Inf. Theory* **38**, 617–643.
- Mallat, S. & Zhong, S. 1992 Characterization of signals from multiscale edges. *IEEE Trans. Pattern Anal. Mach. Intell.* **14** (7), 710–732.
- Meniconi, S., Brunone, B. & Ferrante, M. 2011a In-line pipe device checking by short-period analysis of transient tests. *J. Hydraul. Eng.* **137** (7), 713–722.
- Meniconi, S., Brunone, B., Ferrante, M. & Massari, C. 2011b Potential of transient tests to diagnose real supply pipe systems: what can be done with a single extemporary test. *J. Water Res. Plan. Manage.* **137** (2), 238–241.
- Meniconi, S., Brunone, B., Ferrante, M. & Massari, C. 2011c Transient tests for locating and sizing illegal branches in pipe systems. *J. Hydroinform.* **13** (3), 334–345.
- Meniconi, S., Brunone, B. & Ferrante, M. 2012a Water-hammer pressure waves interaction at cross-section changes in series in viscoelastic pipes. *J. Fluids Struct.* **33**, 44–58.
- Meniconi, S., Brunone, B., Ferrante, M. & Massari, C. 2012b Transient hydrodynamics of in-line valves in viscoelastic pressurized pipes: long-period analysis. *Exper. Fluids* **53** (1), 265–275.
- Meniconi, S., Duan, H.-F., Lee, P., Brunone, B., Ghidaoui, M. & Ferrante, M. 2013 Experimental investigation of coupled frequency- and time-domain transient test-based techniques for partial blockage detection in pipelines. *J. Hydraul. Eng.* **139** (10), 1033–1040.
- Mohapatra, P. K., Chaudhry, M.-H., Kassem, A. A. & Moloo, J. 2006 Detection of a partial blockages in a branched piping system by the frequency response method. *J. Fluids Eng.* **128**, 1106–1114.
- Mpesha, W., Gassman, S. L. & Chaudhry, M.-H. 2001 Leak detection in pipes by frequency response method. *J. Hydraul. Eng.* **127** (2), 134–147.
- Mpesha, W., Chaudhry, M.-H. & Gassman, S. L. 2002 Leak detection in pipes by frequency response method using a step excitation. *J. Hydraul. Res.* **40** (1), 55–62.
- Pezzinga, G. 1999 Quasi-2D model for unsteady flow in pipe networks. *J. Hydraul. Eng.* **125** (7), 676–685.
- Sattar, A. M., Chaudhry, M. H. & Kassem, A. A. 2008 Partial blockage detection in pipelines by frequency response method. *J. Hydraul. Eng.* **134** (1), 76–89.
- Soares, A. K., Covas, D. I. C. & Reis, L. F. R. 2011 Leak detection by inverse transient analysis in an experimental PVC pipe system. *J. Hydroinform.* **13** (2), 153–166.

- Stephens, M., Lambert, M., Simpson, A. & Vitkovsky, J. 2011 [Calibrating the water hammer response of a field pipe network by using a mechanical damping model](#). *J. Hydraul. Eng.* **137** (10), 1225–1237.
- Stephens, M., Lambert, M. & Simpson, A. 2013 [Determining the internal wall condition of a water pipeline in the field using an inverse transient](#). *J. Hydraul. Eng.* **139** (3), 310–324.
- Stoianov, I., Karney, B., Covas, D., Maksimovic, C. & Graham, N. 2001 Wavelet processing of transient signals for pipeline leak location and quantification. In: *Proceedings of International Conference on Computing and Control for the Water Industry (CCWI)*, 1, De Montfort University, Leicester, UK, pp. 65–76.
- Swaffield, J. & Boldy, A. 1993 *Pressure Surges in Pipe and Duct Systems*. Avebury Technical, Gower Press, Aldershot, UK.
- Taghvaei, M., Beck, S. & Boxall, J. 2010 Leak detection in pipes using induced water hammer pulses. *Int. J. COMADEM* **13** (1), 19–25.
- Wang, X.-J., Lambert, M. & Simpson, A. 2005 [Detection and location of a partial blockage in a pipeline using damping of fluid transients](#). *J. Water Resour. Plan. Manage.* **131** (3), 244–249.
- Wylie, E. & Streeter, V. 1993 *Fluid Transients in Systems*. Prentice-Hall, Englewood Cliffs, NJ.

First received 8 March 2014; accepted in revised form 19 August 2014. Available online 22 September 2014