

## Efficacy of combined disinfection with a nitric oxide donor in controlling biofilm formation on the reverse osmosis water pathway for hemodialysis

Yoshihiro Tange<sup>a,\*</sup>, Ayane Murata<sup>b</sup> and Shigenori Yoshitake<sup>c</sup>

<sup>a</sup> Department of Advanced Medical Sciences, Faculty of Medicine, Oita University, 1-1 Idaigaoka, Hasama-machi, Yufu City, Oita 879-5593, Japan

<sup>b</sup> Department of Medical Engineering, Kyushu University of Health and Welfare, 1714-1 Yoshinomachi, Nobeoka City, Miyazaki 882-8508, Japan

<sup>c</sup> Department of Clinical Psychology, Kyushu University of Health and Welfare, 1714-1 Yoshinomachi, Nobeoka City, Miyazaki 882-8508, Japan

\*Corresponding author. E-mail: ytange@oita-u.ac.jp

 YT, 0000-0003-2945-6194

### ABSTRACT

The water treatment system for hemodialysis (HD) is used to treat multiple patients requiring HD simultaneously. This system requires a large amount of purified reverse osmosis (RO) water. However, a major drawback of this method is the formation of biofilms in dialysate pathways. The purpose of this study was to investigate the efficacy of NOC 18, a nitric oxide (NO) donor that can be used at neutral pH, in disinfecting the RO water pathway. Silicone tubes were obtained from the terminal sites of two different HD units. The biofilm coverage and mean biofilm thickness on the tube lumen were evaluated by scanning electron microscopy. The results demonstrated that treatment with NOC 18 alone and in conjunction with sodium hypochlorite reduced biofilm coverage and mean biofilm thickness. Thus, NO donor is a potential disinfectant that enhances bacterial dispersion from biofilms formed on the silicone tube lumen and reduces biofilm coverage and thickness on the RO water pathway at neutral pH. Furthermore, combined disinfection with the NO donor and sodium hypochlorite might enhance biofilmremoval efficacy in clinical practice.

**Key words:** biofilm, hemodialysis, nitric oxide donor, NOC 18, water purification, water treatment system

### HIGHLIGHTS

- NO donor reduces microbial in the RO water pathway for hemodialysis.
- NOC 18 reduces biofilm coverage and thickness under neutral pH conditions.
- Disinfection ability of NO donor alone is weak.
- NO donor and sodium hypochlorite together increase biofilm removal.
- The cleaning method using NOC 18 is environmentally friendly.

### INTRODUCTION

A large amount of purified reverse osmosis (RO) water is required for hemodialysis (HD) in patients. In general, the dialysate volume required for an HD patient is over 30 L/h. Biofilms are hotbeds for bacteria and, once formed, are extremely challenging to eradicate. Moreover, dialysis tubing may be colonized by viable bacteria, which are notoriously difficult to eliminate by conventional heat and chemical disinfection processes (Phillips *et al.* 1994). In the HD system, the favorable sites for biofilm formation include the water treatment system, water distribution pathways, and dialysis unit because of contamination by water-borne bacteria, presence of organic nutrients, and high pH due to bicarbonate-buffered solutions (Cappelli *et al.* 2003). The presence of biofilms in HD systems is a point of concern because biofilms continuously release microbial components, such as toxin fragments, peptides, and polysaccharides, which are of small molecular weight and able to across HD membranes (Cappelli *et al.* 2006). When these substances from the dialysate side reach the patients' blood side by back filtration in HD membranes, they activate circulating mononuclear cells to produce proinflammatory cytokines. These cytokines are mediators of the acute phase response and result in elevated levels of acute phase proteins, such as C-reactive protein. This consequently induces a state of microinflammation, which contributes to progressive inflammatory diseases during chronic renal failure (Lonnemann 2000). Moreover, when endotoxin (ET), a lipopolysaccharide that is a component

This is an Open Access article distributed under the terms of the Creative Commons Attribution Licence (CC BY-NC-ND 4.0), which permits copying and redistribution for non-commercial purposes with no derivatives, provided the original work is properly cited (<http://creativecommons.org/licenses/by-nc-nd/4.0/>).

of the outer cell wall membrane of Gram-negative bacilli, in dialysates enters the blood via a dialyzer, it may activate mononuclear cells and increase cytokine production, causing various complications (Masakane 2006). Additionally, biofilms are highly resistant to disinfectants because of their mixed bacterial community structure and their ability to form exopolysaccharides. Thus, it is recommended to prevent initial biofilm growth by selecting appropriate materials for the dialysis water distribution system in conjunction with compatible disinfectants (Coulliette & Arduino 2013). Sodium hypochlorite and acetic/peracetic acid are used for disinfection as potent bactericidal and anti-scaling agents, respectively.

In HD patients, using ultrapure dialysate decreases inflammation and oxidative stress markers, increases serum albumin and hemoglobin, and lowers the erythropoietin requirement (Susantitaphong *et al.* 2013). Furthermore, online hemodiafiltration, which utilizes ultrapure substitute dialysis fluid, reduces mortality (Kikuchi *et al.* 2019) and lowers the occurrence of cardiovascular events (Okada *et al.* 2021). Besides being cost-effective, purifying the water treatment system minimizes complications in HD patients (Upadhyay *et al.* 2017). Therefore, the distribution of purified RO water is essential.

Barraud *et al.* (2009) reported that nitric oxide (NO) donors (sodium nitroprusside, S-nitroso-N-acetylpenicillamine, and S-nitroso-L-glutathione) were effective against all biofilms tested and that NO can have antimicrobial effects against multi-species communities without being strain-selective. Moreover, combinatorial treatments of low levels of NO and chlorine, which appear acceptable for use in aquatic environments, achieved up to 99.97% eradication of biofilms.

Based on their study, we investigated whether it is possible to remove the biofilm in the RO water pathway using an NO donor solution. We also analyzed the combined effect of sodium hypochlorite and NO donor on biofilm coverage and thickness in RO water tubing to explore its potential as a novel biofilm removal or dispersion treatment.

## METHODS

### Dependence of dose–response concentrations of NO on the silicone tube lumen and biofilm thickness *in vitro*

We used NOC 18 (Dojindo Laboratories, Kumamoto, Japan) as an NO donor because, at 21 h, it has the longest half-life among the NOC series. NOC 18, a small molecule NO donor, is a diazeniumdiolate (NONOate) designed to release NO at a slower rate than other available NONOates. To evaluate the dependence of NOC 18 concentration on the biofilm thickness on the tube lumen, silicone tubes were procured from RO-washed HD units. NOC 18 powder was dissolved in 10 mL of 0.1 M sodium hydroxide (Wako, Tokyo, Japan) to prepare a 10 mM stock solution. The stock solution was diluted with phosphate buffer solution (pH 7.4; Wako, Tokyo, Japan) to obtain 10  $\mu$ M, 1 mM, and 5 mM NOC 18 solutions.

The silicone tube samples were divided into three test tubes containing 10  $\mu$ M, 1 mM, and 5 mM concentrations of NO, respectively, and stored for 2 days. The biofilm coverage and thickness were observed and determined using scanning electron microscopy (SEM; JSM-6510LV, JEOL, Tokyo, Japan) and ImageJ (National Institutes of Health, USA) software, respectively.

### SEM observation

After freeze-drying, which preserves fine structures (Ishida *et al.* 2022), the silicone tube lumen and its cross-section were examined under an SEM (Figure 1). The biofilm coverage and mean biofilm thickness on the silicone tubes were measured using the open-source software ImageJ. Random images (1,000 $\times$  magnification) were taken to evaluate each sample. The obtained images were binarized, and the biofilm coverage area was measured. The mean biofilm thickness was then calculated by dividing the biofilm area by the tube length.

### Efficacy of NOC 18 in controlling biofilm formation on the RO water pathway

To demonstrate the efficacy of NOC 18 in dispersing or eliminating biofilms from RO water pathways, this study was conducted in a simulated dialysis model comprising 10 installed HD units (Figure 2).

### Water treatment system

As a water treatment system, an RO device (MIZ 752PC-B series, Japan Water Systems Corporation, Tokyo, Japan) that had been used for 13 years in this study. Many dialysis facilities use a low concentration of sodium hypochlorite (approximately 20–50 ppm), high temperatures (>80 °C), or RO water washing alone to maintain the RO water quality for RO water pathways. Among them, our study used 500 mL/min/HD unit of RO washing alone as a hydraulic condition for the line wash. During the experiment, ET concentration and microbial colony count in the RO tank were constrained to the ranges 0.00279–0.05657 EU/mL and 79–141 CFU/mL, respectively. We measured the ET concentrations in the RO water pathway

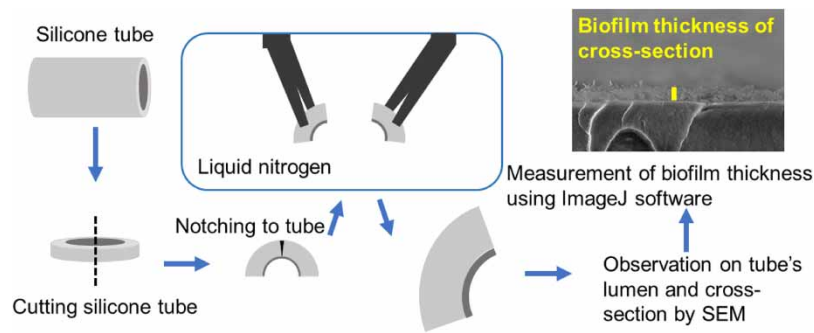

**Figure 1** | Silicone tube preparation for SEM analysis. The silicone tubes were halved lengthwise. A slit was made halfway through the exterior of the silicon tube, followed by another slit on the interior of the tube immersed in liquid nitrogen. The specimens were vacuum-dried and platinum-coated. The sample was then observed under an SEM to examine the silicone tube lumen and its cross-section.

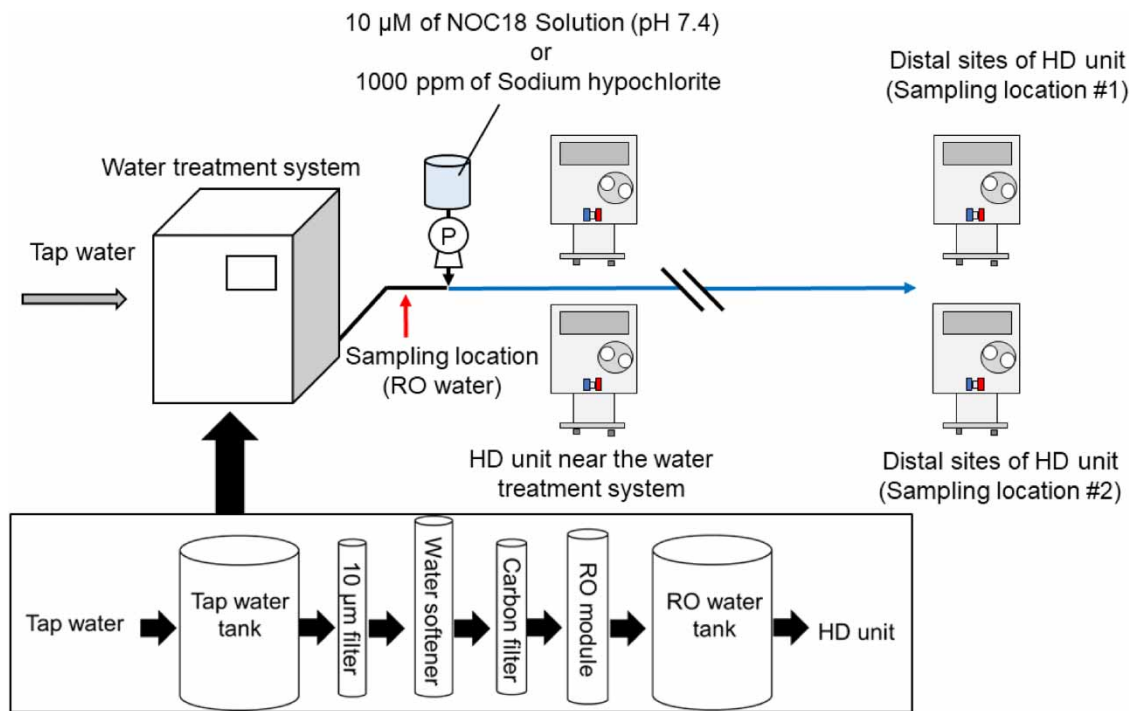

**Figure 2** | Schematic diagram of the RO water pathway. The RO pathway employed in this study contained 10 HD units. Following RO washings on Fridays, NOC 18 (an NO donor) solution was delivered through the pathways. Samples were obtained from two different terminal sites (#1 and #2) in the system.

(LAL mini, Fujifilm Wako, Osaka, Japan) using an ET analyzer (Toxinometer<sup>®</sup> mini, Fujifilm Wako, Japan) system. Bacterial colonies were counted using Reasoner's Agar No. 2 agar medium (BD BBL<sup>™</sup>, Tokyo, Japan) and incubated at 24 °C for 7 days.

#### Preparation of NOC 18 solution to disinfect the RO water pathway

NOC 18 has earned preference as a disinfectant by enabling the continuous delivery of NO to the RO water pathway. NOC 18 was diluted with phosphate buffer to prepare a 10 µM NOC 18 solution. Following a 2 h cleaning with RO water on Fridays, the NOC 18 solution was retained in the RO water tubes from Friday through Monday. The pipes were then washed out with

RO water from Monday through Friday for 2 h/day. This cycle was implemented for 6 weeks, with NOC 18 retention being conducted six times in total (Figure 3).

### Disinfection of the RO water pathway with a combination of NOC 18 and sodium hypochlorite

The NOC 18 solution was retained in the RO water pipes on Saturdays and Sundays, and on Mondays, the dialysis fluid pathways were washed out with 1,000 ppm of sodium hypochlorite (ECO-200, Amtech, Osaka, Japan) for 2 h. Following sodium hypochlorite disinfection, 2 h of RO washing was conducted per day until Fridays. NOC 18 retention and 1,000 ppm of sodium hypochlorite disinfection were carried out three times each over a 3-week period (Figure 3). Thereafter, silicone tubes were obtained from the same HD units (#1 and #2), and the biofilm coverage ratio and mean thickness of samples were measured using ImageJ software.

### Statistical analysis

Statistical analyses were performed using GraphPad Prism 7.05 (GraphPad Software, Inc., La Jolla, CA, USA). Data were presented as the mean  $\pm$  SD. For multiple-group comparisons, one-way analysis of variance with Tukey's multiple comparisons test was used. A  $p$ -value of less than 0.05 was considered statistically significant.

## RESULTS

### *In vitro* observation of biofilm thickness under different NOC 18 concentrations using SEM

Figure 4 depicts the *in vitro* evaluation of the silicone tube lumen and cross-section at three different NOC 18 solution concentrations. Biofilm coverages were  $58.9 \pm 5.3$ ,  $45.9 \pm 2.5$ , and  $34.7 \pm 4.0\%$  at 10  $\mu$ M, 1 mM, and 5 mM of NOC 18 concentrations, respectively. Mean biofilm thickness was 7.85 (range 4.4–11.2  $\mu$ m), 2.29 (0.8–4.4  $\mu$ m), and 1.06 (0.0–2.5  $\mu$ m) at 10  $\mu$ M, 1 mM, and 5 mM of NOC 18 concentrations, respectively. Increasing concentrations of NOC 18 significantly decreased the biofilm coverage ( $p < 0.01$ ,  $n = 4$ ).

### Changes in microbial colony counts and biofilms in RO water pathways using 10 $\mu$ M of NOC 18 solution

Figure 5 depicts changes in microbial colony counts during the experimental period. The baseline of microbial colony counts of HD units #1 and #2 were 747 and 823 CFU/mL, respectively. After 6 weeks, the microbial colony counts of HD units #1 and #2 decreased to 242 and 254 CFU/mL, respectively. In all the samples, after ET retentive filter (ETRF) (EF-02, NIKKISO, Tokyo, Japan), microbials and ETs were not detected.

Figure 6 depicts an evaluation of the silicone tube lumen and cross-section. The control sample had a biofilm coverage and thickness of  $79.9 \pm 3.0\%$  and 10.3  $\mu$ m (range 5.51–14.9  $\mu$ m), respectively. Upon the retention of NOC 18 for 6 weeks, the biofilm coverage and thickness of the two terminal sampling sites were  $62.5 \pm 5.5\%$  and 3.19  $\mu$ m (range 1.75–5.20  $\mu$ m) and  $66.6 \pm 2.3\%$  and 7.75  $\mu$ m (range 5.61–9.60  $\mu$ m), respectively. For biofilm coverage, a significant difference was confirmed

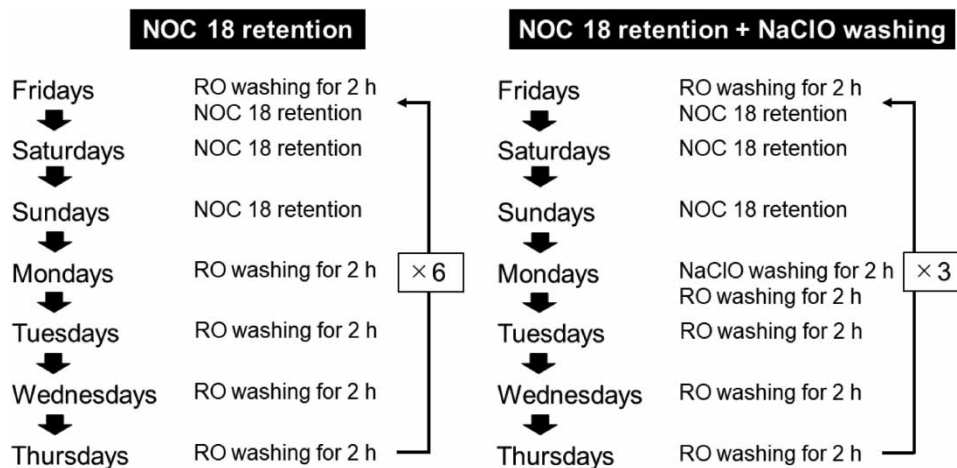

**Figure 3** | Study protocols. Preparation of NOC 18 solution to disinfect the RO water pathway (left) and the disinfection of the RO water pathway with a combination of NOC 18 and sodium hypochlorite (NaClO) (right).

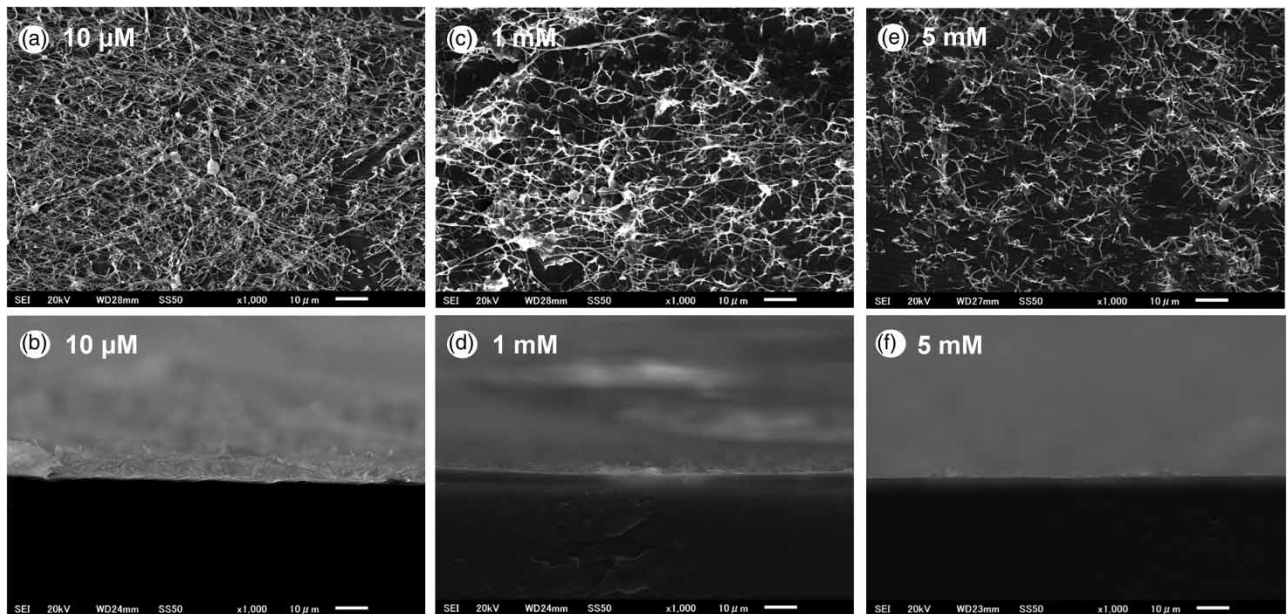

**Figure 4** | SEM analysis of biofilm coverage and thickness at different NOC 18 concentrations. The upper and lower figures illustrate the tube lumens and their cross-sections, respectively. Biofilm coverage and thickness on the tubes at 10  $\mu\text{M}$ , 1 mM, and 5 mM of NOC 18 concentrations are depicted as (a, b), (c, d), and (e, f), respectively. Images are displayed at 1,000 $\times$  magnification. Scale bars represent 10  $\mu\text{m}$ .

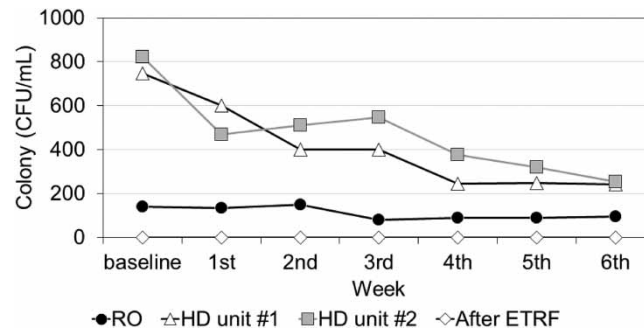

**Figure 5** | Changes in microbial colony counts. The baseline of microbial colony counts of HD units #1 and #2 were 747 and 823 CFU/mL, respectively. After 6 weeks, the microbial colony counts of both #1 and #2 HD units decreased to 67.6 and 69.1%, respectively.

between control and HD units #1 and #2 ( $p < 0.01$ ,  $n = 4$ ); however, no significant difference was observed between units #1 and #2 ( $p = 0.34$ ,  $n = 4$ ).

#### Results of 1,000 ppm sodium hypochlorite disinfection after NOC 18 retention in the RO water pathway

An evaluation of the silicone tube lumen and cross-section is illustrated in Figure 7. Biofilm formation in the silicone tube lumen was significantly reduced following a combined treatment with NOC 18 and sodium hypochlorite compared to that of disinfection with NOC 18 alone. Biofilm coverage and mean biofilm thickness on the HD unit silicone tubes (#1 and #2) were recorded as  $10.5 \pm 1.2\%$  and  $0.49 \mu\text{m}$  (range 0.0– $0.9 \mu\text{m}$ ) and  $3.4 \pm 1.4\%$  and  $0.35 \mu\text{m}$  (range 0.0– $0.59 \mu\text{m}$ ), respectively.

#### Results of ET concentration and microbial colony counts by combined disinfection with NOC 18 and sodium hypochlorite

Changes in ET concentration by combined disinfection with NOC 18 and sodium hypochlorite are illustrated in Figure 8. The baseline ET concentrations in HD units #1 and #2 were 0.05657 and 0.09388 EU/mL, respectively. At the first, second, and

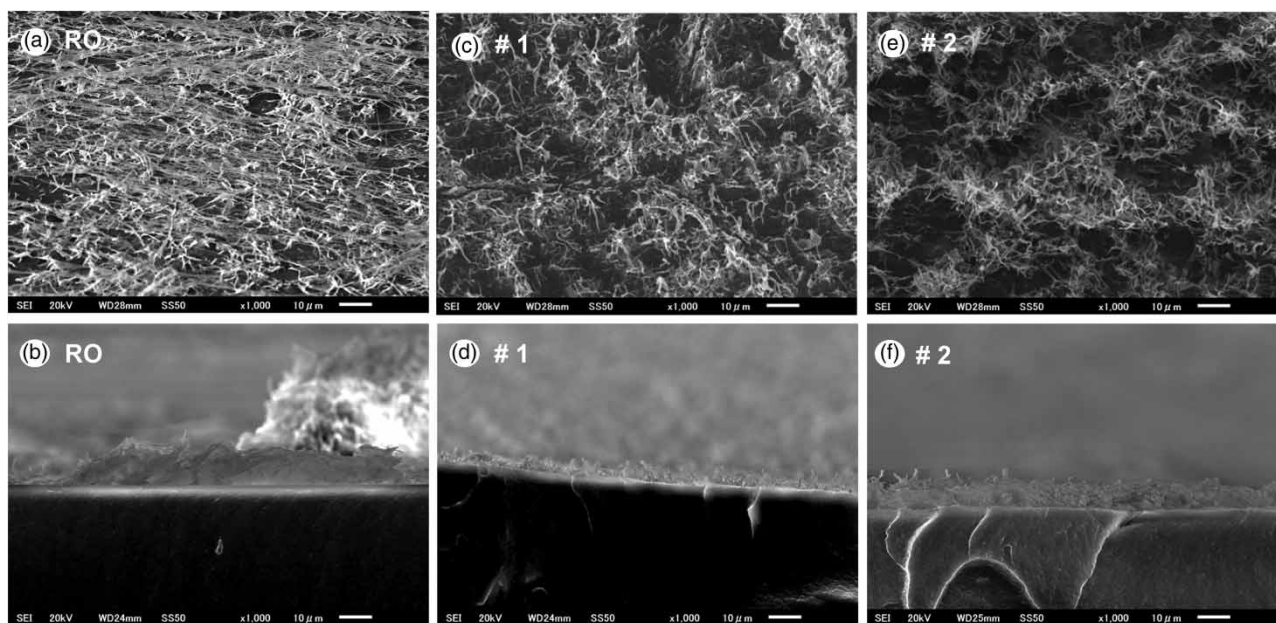

**Figure 6** | SEM analysis of biofilm coverage and thickness following 6 weeks of NOC 18 retention. The upper and lower figures illustrate the tube lumens and their cross-sections, respectively. Biofilm coverage and thickness of the tubes at RO (control) and HD units #1 and #2 are depicted as (a, b), (c, d), and (e, f), respectively. Images are displayed at 1,000 $\times$  magnification. Scale bars represent 10  $\mu$ m.

third weeks, the ET concentration in HD units #1 and #2 decreased to 0.006979 and 0.004273 EU/mL; 0.01677 and 0.003227 EU/mL; and 0.003276 and 0.002876 EU/mL, respectively.

The baseline microbial colony counts in HD units #1 and #2 were 23 and 24 CFU/mL, respectively. At the first, second, and third weeks, the microbial colony counts in HD units #1 and #2 decreased to 7 and 3 CFU/mL; 49 and 1 CFU/mL; and 5 and 1 CFU/mL, respectively.

These values were within the range of viable bacteria count of less than 100 CFU/mL and the ET concentration of 0.050 EU/mL for dialysis water indicated in the Japanese Society for Dialysis Therapy Standard of fluids for HD and related therapies updated in 2016 (Mineshima *et al.* 2018).

## DISCUSSION

This study demonstrated that NO donors facilitate bacterial dispersal from biofilms in RO water tubes. Moreover, high NOC 18 concentrations reduce biofilm coverage and mean thickness on silicone tubes. Both NO donor alone and combined disinfection with NO donor and sodium hypochlorite are effective treatments for biofilm removal. Thus, our findings highlight an effective biofilm removal method using NO donors.

Based on the findings of Barraud *et al.* (2009), we used an NO donor as a disinfectant for RO water piping. In brief, compared to that in untreated biofilms, the efficacy of conventional chlorine treatments at removing multi-species biofilms from water systems was increased in biofilms treated with NO (Barraud *et al.* 2009).

Compared to a standard water treatment system for HD, using a highly purified water-producing system undergoing regular disinfection treatment significantly reduces biofilm formation, bacterial growth, and ET concentrations in a highly vulnerable part of a water treatment system (Man *et al.* 1998). HD water treatment systems have been treated with low-concentration disinfectants to inhibit bacterial growth. For instance, weekly disinfection with 5 ppm sodium hypochlorite was more effective than monthly disinfection with 100 ppm sodium hypochlorite (Tagaya *et al.* 2021). We previously reported a cleaning strategy to maintain ultrapure dialysate and prevent biofilm formation (Ohno *et al.* 2023). Thus, the water treatment system should maintain continuous water circulation and use a low concentration of disinfectant for water treatment to ensure sanitized water piping.

Typically, dialysis pipes installed in the HD room are utilized for more than 10 years. A challenge test conducted with a solution containing a high concentration of ET revealed that ETRF did not completely restrict ET (Nozaki *et al.* 2022). Therefore, the prevention of biofilm formation on dialysis tubing should not solely rely on ETRF to produce ultrapure dialysis fluid.

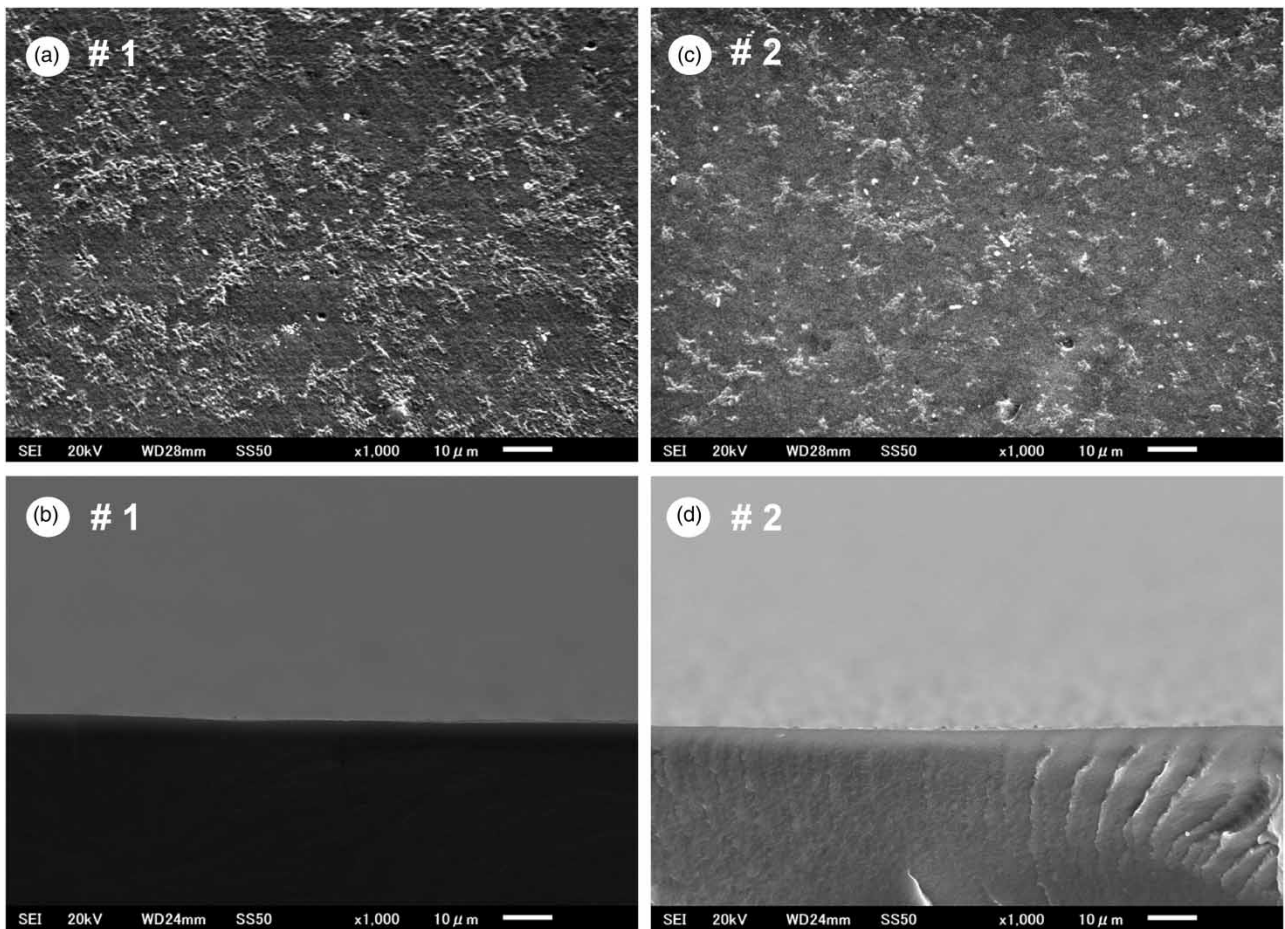

**Figure 7** | SEM analysis of the biofilm thickness on the silicone tube lumen after NOC 18 retention and 1,000 ppm NaClO treatment. The upper and lower figures illustrate the tube lumen and its cross-section, respectively. Biofilm coverage and terminal thickness in systems #1 and #2 are depicted as (a, b) and (c, d), respectively. Images are displayed at 1,000 $\times$  magnification. Scale bars represent 10  $\mu$ m.

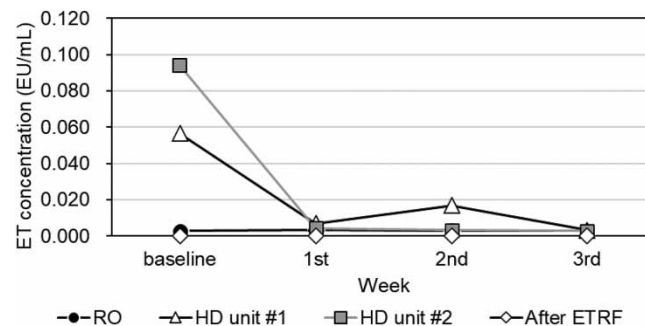

**Figure 8** | Changes in ET concentration. Using NOC 18 and 1,000 ppm of NaClO decreased ET concentrations in HD units #1 and #2.

Our research revealed that the mean biofilm thickness of terminal RO water tubing was less than that of tubing treated with RO wash alone (control). Although the overall composition of the bacterial community in the RO water tubes may differ from that observed by [Barraud \*et al.\* \(2009\)](#), the reduction rate was comparable to that reported in their paper. Furthermore, we observed that biofilm coverage and thickness decreased in inverse proportion to the NOC 18 concentration.

In general, NO can mediate biofilm formation or disperse biofilms (Poh & Rice 2022) at a low level of concentrations less than 1,000  $\mu\text{M}$ . Low-dose NO was proven to prevent or disperse biofilms formed by many different species. Molsidomine, MAHMA NONOate, and diethylamine NONOate are good candidates for either preventing biofilm formation or dispersing biofilms, especially when used in conjunction with disinfectants (Islam *et al.* 2020). In our study, we used 10  $\mu\text{M}$  NOC 18 solution. On the one hand, NOC 18 has a high ability to disperse bacteria from biofilms but a low ability to kill bacteria. On the other hand, sodium hypochlorite has a high sterilizing ability but a low ability to disperse bacteria. Therefore, combining NOC 18 with sodium hypochlorite is a suitable method for continuous cleaning of RO water pathways for HD.

During the observation period, the NO donor was unable to completely remove the biofilm; therefore, more frequent NO donor usage or increased concentration will be required. Co-treatment is imperative in clinical settings, as biofilm dispersal alone results in the translocation of live bacteria to new sites in the body and the subsequent seeding of new infection foci (Fleming & Rumbaugh 2018). We demonstrated that combined disinfection with an NO donor and sodium hypochlorite was a potent antimicrobial treatment strategy for the RO water pathway.

Promoting bacterial dispersal from biofilms with NO donors and subjecting them to bactericidal treatment with sodium hypochlorite are an effective method for decontaminating dialysis tubing to deliver purified dialysis fluid sustainably. However, a concern regarding low or high pH of waste dialysate has been recently reported. In Japan, it is mandatory to maintain the pH of wastewater between 5 and 9. NOC 18 releases NO in the phosphate buffer (pH 7.4). This characteristic is environmentally attractive as wastewater problems using high- and low-pH disinfectants are required to decontaminate the current HD environment.

In summary, NO donors may facilitate the dispersion of bacteria from biofilms, and combining high-concentration NO donors and antimicrobial disinfectant agents may provide a novel cleaning strategy for HD piping to sustainably deliver purified RO water. NOC 18, an NO donor, decreased the thickness of the biofilm adhered to dialysis fluid tubes by facilitating bacterial displacement. The addition of sodium hypochlorite resulted in the elimination of bacteria and, in combination with NOC 18, enabled biofilm removal from the RO tubing to provide purified RO water compared with baseline. These results indicate that NO donors, used at neutral pH, act in a concentration-dependent manner and, in conjunction with sodium hypochlorite, are potential agents for biofilm control in dialysis tubing.

### Limitations of this study

Biofilms are typically analyzed by culturing and staining the bacterial strains residing within an exopolysaccharide matrix. However, biofilms formed on dialysis piping comprise multi-species bacteria, constituting complex communities. Therefore, we concentrated on the coverage and thickness of the biofilms on silicone tube lumens observable using SEM. As the thickness of the biofilms in the samples was determined using liquid nitrogen, it was relatively easy to microscopically image the biofilms. This freeze-drying method restricted the number of images, particularly in cross-section; consequently, we calculated the biofilm thickness as a mean value. This method poses the disadvantage of yielding limited images but facilitates the observation of biofilm conditions in the RO water pathway.

In general, a loop-piping system is used for a single-patient dialysis fluid delivery system. However, in this study, we used a single-pass method. To maintain water purification for RO water, a continuous loop-type RO water piping should have been selected in this study.

### CONCLUSIONS

NO donors can disperse biofilms formed in the RO water pathway of HD units and are promising disinfecting agents that can be used at neutral pH. Since the sterilization effect is weak, incremented NOC 18 concentration or a combination of NO donor and sodium hypochlorite is a promising cleaning strategy for RO water pathways for HD in an environmentally friendly agent.

### ETHICS STATEMENT

No human or animal subjects or materials were used in this study.

### FUNDING

This research did not receive any financial support for the conduct of the research and/or preparation of the article from any funding agencies in the public, commercial, or not-for-profit sectors.



## DATA AVAILABILITY STATEMENT

All relevant data are included in the paper or its Supplementary Information.

## CONFLICT OF INTEREST

The authors declare there is no conflict.

## REFERENCES

- Barraud, N., Storey, M. V., Moore, Z. P., Webb, J. S., Rice, S. A. & Kjelleberg, S. 2009 Nitric oxide-mediated dispersal in single- and multi-species biofilms of clinically and industrially relevant microorganisms. *Microb. Biotechnol.* **2** (3), 370–378. <https://doi.org/10.1111/j.1751-7915.2009.00098.x>.
- Cappelli, G., Sereni, L., Scialoja, M. G., Morselli, M., Perrone, S., Ciuffreda, A., Bellesia, M., Inguaggiato, P., Albertazzi, A. & Tetta, C. 2003 Effects of biofilm formation on haemodialysis monitor disinfection. *Nephrol. Dialysis Transplant.* **18** (10), 2105–2111. <https://doi.org/10.1093/ndt/gfg344>.
- Cappelli, G., Riccardi, M., Perrone, S., Bondi, M., Ligabue, G. & Albertazzi, A. 2006 Water treatment and monitor disinfection. *Hemodial. Int.* **10** (Suppl. 1), S13–S18. <https://doi.org/10.1111/j.1542-4758.2006.01184.x>.
- Coulliette, A. D. & Arduino, M. J. 2013 Hemodialysis and water quality. *Semin. Dialysis* **26** (4), 427–438. <https://doi.org/10.1111/sdi.12113>.
- Fleming, D. & Rumbaugh, K. 2018 The consequences of biofilm dispersal on the host. *Sci. Rep.* **8** (1), 10738. <https://doi.org/10.1038/s41598-018-29121-2>.
- Ishida, H., Matsumoto, C., Shimada, M. & Suzuki, T. 2022 SEM observation of non-fixed and water freeze-dried *Spirostomum ambiguum*. *Eur. J. Protistol.* **85**, 125896. <https://doi.org/10.1016/j.ejop.2022.125896>.
- Islam, M., Durie, I., Ramadan, R., Purchase, D. & Marvasi, M. 2020 Exploitation of nitric oxide donors to control bacterial adhesion on ready-to-eat vegetables and dispersal of pathogenic biofilm from polypropylene. *J. Sci. Food Agric.* **100** (7), 3078–3086. <https://doi.org/10.1002/jsfa.10340>.
- Kikuchi, K., Hamano, T., Wada, A., Nakai, S. & Masakane, I. 2019 Predilution online hemodiafiltration is associated with improved survival compared with hemodialysis. *Kidney Int.* **95** (4), 929–938. <https://doi.org/10.1016/j.kint.2018.10.036>.
- Lonnemann, G. 2000 The quality of dialysate: an integrated approach. *Kidney Int. Suppl.* **76**, S112–S119. <https://doi.org/10.1046/j.1523-1755.2000.07614.x>.
- Man, N. K., Degremont, A., Darbord, J. C., Collet, M. & Vaillant, P. 1998 Evidence of bacterial biofilm in tubing from hydraulic pathway of hemodialysis system. *Artif. Organs* **22** (7), 596–600. <https://doi.org/10.1046/j.1525-1594.1998.06195.x>.
- Masakane, I. 2006 Clinical usefulness of ultrapure dialysate—recent evidence and perspectives. *Ther. Apheresis Dialysis* **210** (4), 348–354. <https://doi.org/10.1111/j.1744-9987.2006.00388.x>.
- Mineshima, M., Kawanishi, H., Ase, T., Kawasaki, T., Tomo, T. & Nakamoto, H. 2018 2016 update Japanese society for Dialysis Therapy Standard of fluids for hemodialysis and related therapies. *Ren. Replace. Ther.* **4** (1), 1–14. <https://doi.org/10.1186/s41100-018-0155-x>.
- Nozaki, H., Tange, Y., Inada, Y., Uchino, T. & Azuma, N. 2022 Leakage of endotoxins through the endotoxin retentive filter: an in vitro study. *Blood Purif.* **51** (10), 831–839. <https://doi.org/10.1159/000520792>.
- Ohno, F., Makinose, S. & Tange, Y. 2023 Effectiveness of combination of heat water disinfection, continuous water circulation, and minimalized dead space for dialysis piping in maintaining ultrapure dialysis fluid and preventing biofilm formation in a central dialysis fluid delivery system. *J. Artif. Organs* **26** (3), 220–225. <https://doi.org/10.1007/s10047-022-01362-z>.
- Okada, K., Michiwaki, H., Tashiro, M., Inoue, T., Shima, H., Minakuchi, J. & Kawashima, S. 2021 Effects of Japanese-style online hemodiafiltration on survival and cardiovascular events. *Ren. Replace. Ther.* **7** (1), 1–10. <https://doi.org/10.1186/s41100-021-00385-1>.
- Phillips, G., Hudson, S. & Stewart, W. K. 1994 Persistence of microflora in biofilm within fluid pathways of contemporary haemodialysis monitors (Gambro AK-10). *J. Hosp. Infect.* **27** (2), 117–125. [https://doi.org/10.1016/0195-6701\(94\)90004-3](https://doi.org/10.1016/0195-6701(94)90004-3).
- Poh, W. H. & Rice, S. A. 2022 Recent developments in nitric oxide donors and delivery for antimicrobial and anti-biofilm applications. *Molecules* **27**, 674. <https://doi.org/10.3390/molecules27030674>.
- Susantitaphong, P., Riella, C. & Jaber, B. L. 2013 Effect of ultrapure dialysate on markers of inflammation, oxidative stress, nutrition and anemia parameters: a meta-analysis. *Nephrol. Dialysis Transplant.* **28** (2), 438–446. <https://doi.org/10.1093/ndt/gfs514>.
- Tagaya, M., Oda, Y., Kimura, A., Irifune, R., Okano, S., Murataka, T., Handa, H. & Takahashi, S. 2021 An easy disinfection strategy for pipes connecting hemodialysis equipment. *Int. J. Artif. Organs* **44** (6), 385–392. <https://doi.org/10.1177/0391398820975034>.
- Upadhyay, A., Susantitaphong, P. & Jaber, B. L. 2017 Ultrapure versus standard dialysate: a cost-benefit analysis. *Semin. Dialysis* **30** (5), 398–402. <https://doi.org/10.1111/sdi.12618>.

First received 1 July 2023; accepted in revised form 25 August 2023. Available online 8 September 2023