

Forward osmosis membrane fouling and cleaning for wastewater reuse

Youngbeom Yu, Seockheon Lee and Sung Kyu Maeng

ABSTRACT

Membrane fouling properties and different physical cleaning methods for forward osmosis (FO) and reverse osmosis (RO) laboratory-scale filtration systems were investigated. The membrane fouling, with respect to flux reduction, was lower in FO than in RO when testing an activated sludge effluent. Cross-flow velocity, air-scouring, osmotic backwashing and effect of a spacer were compared to determine the most effective cleaning method for FO. After a long period of fouling with activated sludge, the flux was fully recovered in a short period of osmotic backwashing compared with cleaning by changing cross-flow velocity and air-scouring. In this study, the osmotic backwashing was found to be the most efficient way to clean the FO membrane. The amount of RNA recovered from FO membranes was about twice that for RO membranes; biofouling could be more significant in FO than in RO. However, the membrane fouling in FO was lower than that in RO. The spacer increased the flux in FO with activated sludge liquor suspended solids of 2,500 mg/L, and there were effects of spacer on performance of FO-MBR membrane fouling. However, further studies are required to determine how the spacer geometry influences on the performance of the FO membrane.

Key words | air-scouring, cross-flow velocity, forward osmosis, membrane fouling, osmotic backwashing, spacer

Youngbeom Yu
K-water Research Institute,
Korea Water Resources Corporation,
462-1 Jeonmin-dong, Yuseong-gu,
Daejeon 05-730,
Republic of Korea

Seockheon Lee
Center for Water Resource Cycle,
Korea Institute of Science and Technology,
Hwarangno14-gil 5, Seongbuk-gu,
Seoul 136-791,
Republic of Korea

Sung Kyu Maeng (corresponding author)
Department of Civil and Environmental
Engineering,
Sejong University,
98 Gunja-Dong, Gwangjin-Gu,
Seoul 143-747,
Republic of Korea
E-mail: smaeng@sejong.ac.kr

INTRODUCTION

In pressure-driven membrane processes, such as microfiltration (MF), ultrafiltration (UF), nanofiltration and reverse osmosis (RO), water is filtered mainly by using hydraulic pressure as a driving force. The use of hydraulic pressure in such systems requires a large amount of energy and leads to significant fouling on the membrane surface. Thus, the biggest challenge of pressure-driven membrane processes is control of fouling, which is inevitable, and many studies have consequently focused on the control of fouling for such systems (Hong & Elimelech 1997; Li & Elimelech 2004; Lee & Elimelech 2006; Kim *et al.* 2008; Shon *et al.* 2008; Ngo & Guo 2009; Zhang *et al.* 2015; She

et al. 2016). Nevertheless, the control of fouling still remains a challenge for water treatment industries, and researchers have developed novel filtration processes and membrane modifications for more efficient filtration systems.

Over the past decade, there has been growing interest in osmotically driven membrane processes, such as forward osmosis (FO), as highly efficient, sustainable processes that can replace the pressure-driven membrane processes (McCutcheon *et al.* 2006; Lutchmiah *et al.* 2014). In the pressure-driven membrane process, water is filtered by applying hydraulic pressure; in the FO process, water is filtered by using osmotic pressure as the driving force. The main advantages of the FO process are no need for hydraulic pressure and a high removal rate exhibited for a wide range of contaminants (Cath *et al.* 2006), and lower susceptibility to membrane fouling than pressure-driven membrane

This is an Open Access article distributed under the terms of the Creative Commons Attribution Licence (CC BY 4.0), which permits copying, adaptation and redistribution, provided the original work is properly cited (<http://creativecommons.org/licenses/by/4.0/>).

doi: 10.2166/wrd.2016.023

processes (Mi & Elimelech 2008; Mi & Elimelech 2010; Kim *et al.* 2014). The FO process in water treatment is applicable to leachate and wastewater treatment, water reuse, brackish groundwater and seawater desalination (Kravath & Davis 1975; Cath *et al.* 2005a, 2005b; Phuntsho *et al.* 2014). Interest in FO technology has grown significantly as the commercialization of membranes designed for FO process is possible, but it has been slower for wastewater applications (Lutchmiah *et al.* 2014).

Membrane bioreactors (MBRs) are often used in processing wastewater for reuse. Activated sludge used for biological wastewater treatment processes has a high mixed liquor suspended solids (MLSS) content and extracellular polymeric substances and causes significant membrane fouling. Therefore, the membrane biofouling is an important factor when FO is considered for wastewater treatment. FO processes can be suitable for application in the MBRs because of the low membrane fouling characteristics (Achilli *et al.* 2009). The wastewater reuse process involves the serial connection of the membranes to a conventional activated sludge process, or the connection of the RO membrane to the MBR process. Integrated/hybrid membrane processes may be necessary to meet stringent water quality standards for water reuse and could reduce water scarcity (Ang *et al.* 2015).

The FO-MBR process uses the FO membrane instead of the MF or UF membranes that are commonly used in existing MBR systems. The FO-MBR process is an advanced technology for wastewater reuse; it requires low energy and has a good removal efficiency for organic matter (Cornelissen *et al.* 2008; Achilli *et al.* 2009). The major advantage of the FO-MBR process is its long filtration time due to the lower level of membrane fouling, long cycle of backwashing, high removal rate of foulants, and, in contrast to membranes with an angstrom pore size, its suitability for osmotic backwashing. There are two approaches to osmotic backwashing. Feed water may be substituted for the second draw solution at a higher concentration than the draw solution. The other approach is that the flow of the draw solution can be changed from one side (permeate side) of the membrane to the other (feed) side of the membrane, thus removing the foulants. FO membrane cleaning methods and steps, which are required for FO to reach wastewater application and water reclamation

standards, have been reviewed recently (Lutchmiah *et al.* 2014; She *et al.* 2016). However, there are limited studies investigating cleaning methods such as cross-flow velocity, air-scouring, osmotic backwashing and use of spacers in wastewater reuse in FO and compared to RO.

Thus, the purpose of this study is to understand membrane fouling properties by evaluating physical cleaning methods in FO-MBR. We first analysed the fouling characteristics in FO and RO processes using activated sludge or secondary effluent. We then evaluated the cleaning efficiency of various physical cleaning methods, such as the shear force of increasing cross-flow velocity, air-scouring, osmotic backwashing and spacers.

MATERIALS AND METHODS

FO membrane and surface characterization

A commercial cellulose triacetate FO membrane obtained from Hydration Technology Innovations LLC (Scottsdale, AZ, USA) was used in this study. This membrane has an asymmetric structure supported by an embedded polyester mesh and total thickness of the membrane is approximately 50 μm (McCutcheon *et al.* 2005). The membranes were stored in deionized (DI) water at 4 °C with water replaced regularly prior to experiments. The RO membrane is composed of polyamide and thin film and was obtained from Dow-Filmtec (Minneapolis, MA). The membranes were characterized for chemical and physical properties and results are summarized in Table 1.

The roughness of the membrane surface was determined by atomic force microscope (AFM) analysis (PUCOStation AFM, Surface Imaging Systems, Herzogenrath, Germany) and was quantified in terms of the root mean square (RMS) roughness, which is the RMS deviation of the peaks and

Table 1 | Surface characteristics of the membranes

Membrane	RMS roughness (nm)	Surface charge (mV)	Contact angle (°)
FO	1.16	-13.44	69.5
RO	87.65	-24.01	24.9

valleys from the mean plane (Vrijenhoek *et al.* 2001). The contact angle measurements were performed with a goniometer (DM 500, Kyowa Interface Science, Japan). The equilibrium contact angle measurements are based on the measurements described by Marmur (1996). The membrane zeta potential was determined by means of a streaming current electrokinetic analyser (SurPass, Anton Paar GmbH, Graz, Austria) and a procedure described by Luxbacher (2006). The zeta potential was calculated on the basis of the Fairbrother and Mastin substitution (Fairbrother & Mastin 1924).

Model test solutions

Silica (SiO₂) particles in a powdered form (particle diameter 1–5 µm) were used as model particulate foulants. The silica particles were diluted with DI water to the concentration of 5,000 mg/L and were sonicated for 3 min to prevent particle aggregation before use.

Commercial Aldrich humic acid was used as a model colloidal organic foulant (Costa *et al.* 2006). A stock solution was prepared by dissolving humic acid in DI water and was sonicated for 3 min and then adjusted to a concentration 1,000 mg/L. For the production of feed water, the stock solution was diluted with DI water to a concentration of 200 mg/L. The humic acid particle diameters were determined by Zetasizer analysis (Nano-ZS, Malvern, UK): the overall particle size distribution was observed to be between 25 nm and 75 nm. The artificial test solution for the fouling experiments contained 200 mg/L humic acid, 50 mM NaCl and 3 mM CaCl₂. The feed water pH was fixed at 7.0.

Activated sludge and secondary effluent were taken from the wastewater treatment plant in Iansan (Gyeonggi-do, Korea). Samples were carefully delivered to the laboratory and stored in a refrigerator. Dissolved organic carbon was measured with a total organic carbon analyser (TOC-VCPH, Shimadzu, Japan). MLSS, dissolved organic carbon, total nitrogen (TN), ammonia (NH₄-N) and total phosphorus (TP) were measured in accordance with *Standard Methods* (APHA 1999).

Laboratory-scale membrane test systems

The fouling and cleaning experiments were performed in an FO and RO laboratory-scale cross-flow membrane test unit. The FO membrane test unit (Figure 1) consisted of a

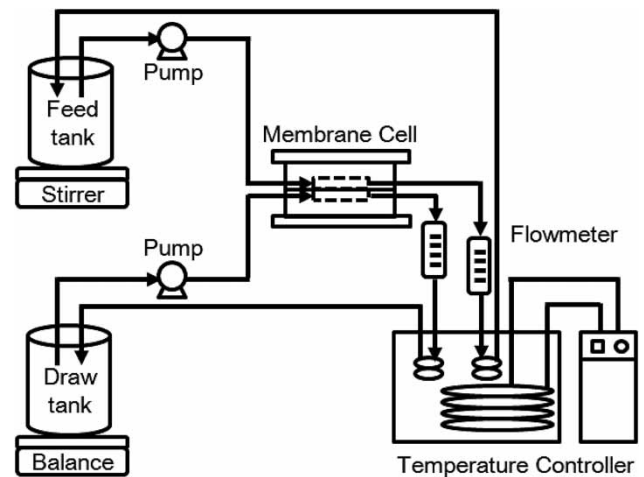

Figure 1 | A schematic diagram of the laboratory-scale FO system.

flat-sheet-type membrane cell, two gear pumps (Cole Parmer, USA), feed and draw solution reservoirs, a magnetic stirrer (Thermo Scientific, USA), a water bath circulator (JS Research Inc., Korea), a digital scale (CAS, Korea) and a digital conductivity meter (HACH, USA). The RO membrane test unit consisted of a flat-sheet-type membrane cell, a hydra-cell pump (Wanner Engineering Inc., USA), a feed solution reservoir, a magnetic stirrer, a water bath circulator and a digital scale.

In the FO membrane test unit, the feed and draw solution were each held in a 2 L reservoir and fed to the membrane cell by gear pumps. The draw solution was 3 M NaCl and was placed on a digital scale, which was monitored by a computer to record the permeate flux. The membrane cell, which contains equally sized channels on both sides of the membrane, was placed in a rectangular channel (cell dimensions: 77 mm × 26 mm × 3 mm). A digital conductivity meter was placed in the feed and draw solution reservoirs, and the conductivity changes were monitored by a computer to record the reverse solute flux.

In the RO membrane test unit, the feed solution was held in a 2 L reservoir and fed to the membrane cell by the hydra-cell pump. The membrane cell, which contains a one-channel membrane, was placed in a rectangular channel (cell dimensions: 77 mm × 26 mm × 3 mm). The cross-flow velocity and trans-membrane pressure in the membrane cell was controlled with a back-pressure regulator and a bypass valve.

In both FO and RO membrane test units, the effective membrane area was 2,000 mm². No spacer was used in the channel for the fouling and cleaning experiments. The cross-flow velocity was 8.5 cm/sec. The feed and draw solution temperatures were controlled by the water bath at approximately 20 °C. The water bath temperature was maintained by circulating chilled water through a stainless-steel coil immersed in a water bath.

Osmotic backwashing

The FO membrane, which uses osmotic pressure without hydraulic pressure, is suitable for osmotic backwashing. In the operating mode, the draw solution flowed on the permeate side. Water is filtered from feed water by using the osmotic pressure itself as the driving force. In the cleaning mode, the flow of the draw solution is changed from one side (permeate side) of the membrane to the other (feed side), and cleaning solution that has a higher concentration than the draw solution flows on the feed side (Figure 2(a)). Osmotic backwashing is a cleaning method involving a flow of water from permeate to feed side by means of osmotic pressure.

RNA analysis on feed water and fouled membranes

Total RNA was extracted from the samples of feed water and fouled membrane surface by using a PowerWater[®] RNA isolation kit (MO-BIO, USA), and the concentration was determined by using a NanoDrop 2000c spectrophotometer (Thermo Scientific, Belgium). The ratios of UV absorbance at 260/280 nm were between 1.8 and 2.1 for all the RNA samples.

RESULTS AND DISCUSSION

Comparison of activated sludge fouling between FO and RO

The flux of RO and FO modes was evaluated for an activated sludge collected from a wastewater treatment plant. MLSS, dissolved organic carbon, TN, NH₄-N and TP of mixed liquor were 2,940 mg/L, 4.2 mg/L, 18.0 mg/L-N, 17.1 mg/L-N

and 5.2 mg/L-P. According to the membrane surface characteristics analysis, RO membrane is relatively more disadvantageous for physical membrane fouling and FO membrane is relatively more disadvantageous for electric and chemical fouling. The initial flux was 6 µm/sec, and the membrane fouling was evaluated for 20 h. As shown in Figure 3, RO exhibited a much higher fouling rate than FO. Generally, the fouling in a biological treatment process such as MBR involves the accumulation of foulants and the formation of a cake layer on the membrane surface (Jiang *et al.* 2003). In RO, the compressible foulants formed a dense cake layer that increased the hydraulic resistance along the membrane and resulted in severe flux decline. However, in FO, the flux decline was due to the cake formation contributed by the enhanced osmotic pressure (Lee *et al.* 2010) (Figure 2(b)). FO did not involve the application of hydraulic pressure; therefore, the foulants were much less compressed when compared to RO mode (Mi & Elimelech 2010). Moreover, Mi & Elimelech (2010) reported that the fouling observed in FO was more reversible than that in RO, and they believed the hydraulic compaction was less on the surface of FO membranes. Therefore, it is easier to clean the membrane surface in FO than in RO, and chemical cleaning, which could disturb microbial community in MBR systems, may not be necessary to restore the water productivity of MBR.

Physical cleaning efficiencies

Physical cleaning methods in osmotically driven membrane processes have been previously studied (Valladares Linares *et al.* 2013; She *et al.* 2016), but limited studies have reported in MBR systems. The physical cleaning efficiencies were evaluated by three surface cleaning methods: the shear force of an increased cross-flow velocity, air-scouring through air injection and osmotic backwashing. Each cleaning method was applied under the same conditions of colloidal organics with a starting flux of 6 µm/sec. The membrane was fouled for 20 h and then cleaned by each of the methods for 1 min each. The flux decreased by about 60% due to the fouling over 20 h prior to all experiments.

Cleaning through the cross-flow velocity was performed at 8.5 cm/sec, 17 cm/sec and 25.5 cm/sec (Figure 4(a)). Air-scouring was performed by applying a fixed value of 12.5%

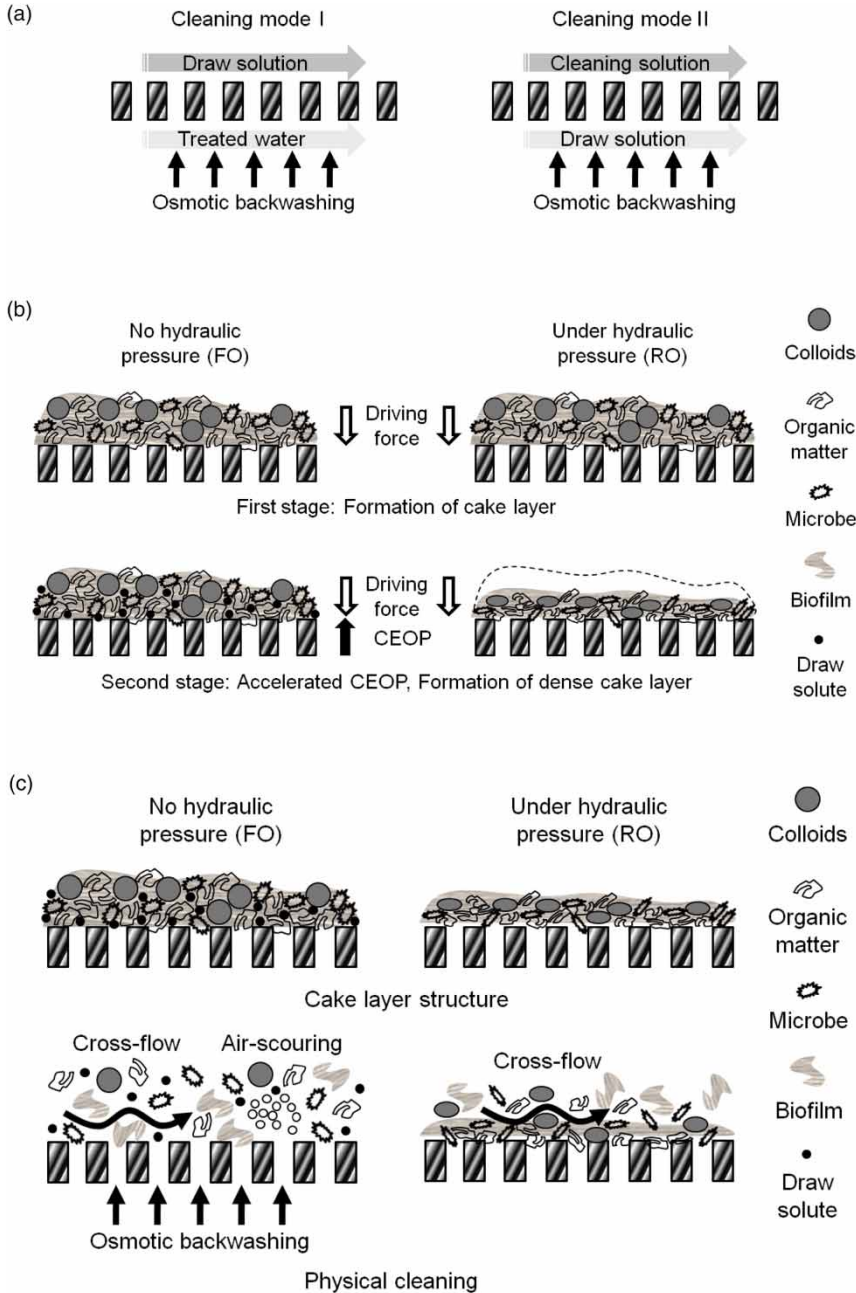

Figure 2 | Proposed schematic illustration of osmotic backwashing (a), fouling stages in FO and RO processes (with and without hydraulic pressure) (b), and cake layer structure and physical cleaning in FO and RO (with and without hydraulic pressure) (c).

and 25% air of the total channel volume to the membrane surface. The flux recovery rate increased by about 10% when the cross-flow velocity increased from 8.5 cm/sec to 17 cm/sec, but it did not show any further increase when the cross-flow velocity reached 25.5 cm/sec. Therefore, the efficiency of the membrane cleaning gradually improved

up to 17 cm/sec of cross-flow velocity, but showed no further improvement when the cross-flow velocity was higher. Therefore, use of a cross-flow velocity over 17 cm/sec is not recommended for cleaning since it does not further increase the flux in FO-MBR systems. It is also important to note that the cross-flow velocity is more

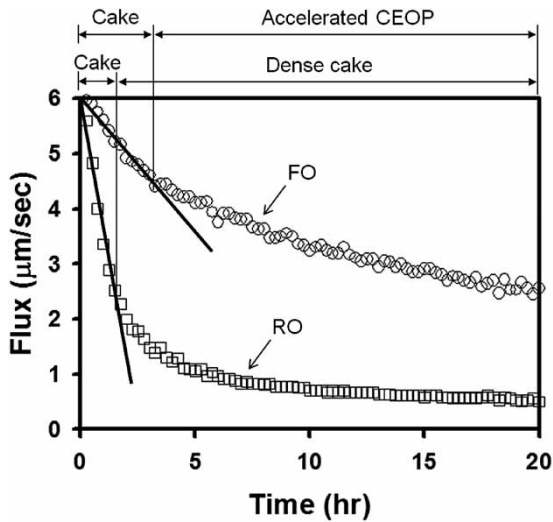

Figure 3 | Effects of RO and FO on the flux decline using activated sludge. CEOP: cake-enhanced pressure.

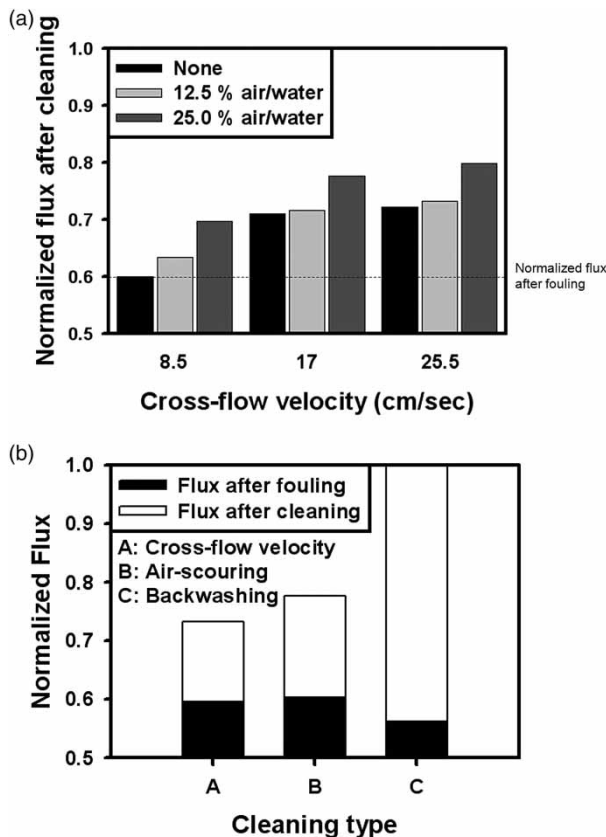

Figure 4 | FO membrane cleaning performed at 8.5 cm/sec, 17 cm/sec and 25.5 cm/sec. The air-scouring was performed by applying a fixed value of 12.5% and 25% air of the total channel volume to the membrane surface (a). Comparison of backwashing efficiency of the FO membrane cleaning using osmotic pressure with cross-flow velocity and air-scouring (b).

effective prior to cake forming compaction (Mi & Elimelech 2008); therefore, increasing cross-flow velocities, as tested in this study for the FO membrane in which the cake layer had already formed, was not effective in recovering the flux.

Air-scouring was also performed at the cross-flow velocity of 17 cm/sec. The levels of air injection increased gradually in three steps (0%, 12.5% and 25%, air of the total channel volumes) and were applied to the membrane surface. There was no significant improvement in the flux recovery rate when the air injection increased from 0% to 12.5% channel air. However, there was some improvement in the flux when the air injection increased from 12.5% to 25% channel air.

Figure 4(b) shows the backwashing efficiency using osmotic pressure in FO compared to cross-flow velocity and air-scouring cleaning methods. The membrane was fouled for 20 h at a starting flux of 6 µm/sec and was then cleaned for 1 min by osmotic backwashing. There was a 55% decrease in the flux at the start of the cleaning due to the 20 h of fouling. After cleaning through the cross-flow velocity or air injection methods, about 75% of the initial flux was recovered after 1 min. However, after cleaning with the osmotic backwashing method, 99.9% of the initial flux was recovered after 1 min. Osmotic backwashing was more effective than surface cleaning; this may be because foulants in the membrane pores had been removed. The results of this experiment confirmed that osmotic backwashing cleaned the membrane much more effectively than other

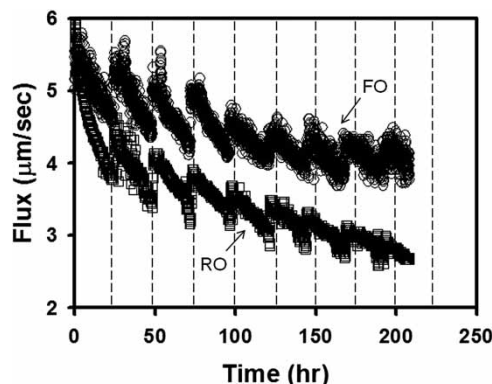

Figure 5 | Fouling experiment in the FO and RO processes with the secondary effluent in the wastewater treatment plant. Experimental conditions for fouling experiments: 3 M NaCl draw solution for FO or 16 bars (232 psi) for RO; feed solution containing secondary effluent; cross-flow velocity 8.5 cm/s; pH of 7.0; and temperature of 20 ± 1 °C; (n = 4,000).

physical cleaning methods in this study and is capable of controlling the cake layer in the FO mode without any outside pressure. In contrast, Valladares Linares *et al.* (2013) reported that the air-scouring method was most effective (89.5% flux recovery), and osmotic backwashing was ineffective in recovering the flux using FO-MBR, which integrated wastewater and seawater. Different feed water characteristics, an important factor in membrane fouling, and operating conditions, including air-scouring intensity, may have affected the fouled layer of FO membranes. In our study, factors involved in the performance of osmotic backwashing were not investigated but can be found in a study carried out by Kim *et al.* (2012). Moreover, the combination of osmotic backwashing and surface backwashing should be investigated as the synergy between two methods can improve the performance of FO-MBR more effectively.

Biofouling and reversibility in FO and compared to RO

A secondary effluent from a wastewater treatment plant was used as the feed water in the membrane fouling experiment in which the FO membrane was fouled for 9 d and the feed water and draw solution were changed once a day during the operation. The flux decreased in FO and RO, but the membrane fouling observed in RO decreased the flux at double the rate of the corresponding rate in FO Figure 5. The degree of membrane fouling increased and the flux diminished over time for 9 d. Table 2 shows the performance of membrane operated in FO and RO processes with respect to water quality improvement. The removal efficiencies for TN, NH₄-N and TP were greater than 90% in FO but less than 90% in RO (TN: 63.3%, NH₄-N: 76.9% and TP: 88.8%). The reverse solute flux from the draw solution in

Table 2 | Influent and effluent concentrations and removal efficiencies in FO and RO mode

Parameter	Inf. conc. (mg/L)	FO mode		RO mode	
		Eff. conc. (mg/L)	Removal efficiency (%)	Eff. conc. (mg/L)	Removal efficiency (%)
TN	16.9	1.3	92.3	6.2	63.3
NH ₄ -N	15.7	0.8	94.7	3.6	76.9
TP	5.3	0.5	91.1	0.6	88.8

FO may increase the removal efficiencies because the solute moves to the reverse of the permeate flux and blocks some foulants in the feed water.

Figure 6 shows the RNA analysis from each fouled membrane surface in FO and RO processes operated for 9 d. Nine samples, each made up of 10 mm² of membrane surface, were collected from the membranes (effective area 2,000 mm²) and subjected to RNA extraction for evaluating the activity of microbes. A comparative analysis of RNA results for the feed water and the fouled membrane surface revealed that many of the microbes were detected, concentrated on the surface of membranes. There was more membrane fouling in RO than that in FO. However, there was about twice as much RNA accumulated in FO than in RO. The cake layer that accumulated through RO had less space for microbes to grow because, in contrast to FO, foulants are compressed by the outside pressure.

After the membrane fouling experiment for FO using activated sludge from a wastewater treatment plant as feed water, an evaluation was made of the efficiency of osmotic backwashing, and the results are shown in Figure 7. The experimental method involved the fouling of the membrane for 3 d with an initial flux of 5.5 μm/sec. A 2 L sample of the activated sludge and a 2 L sample of the draw solution were circulated for 1 d, and the activated sludge and the draw solution were changed once a day. The membrane was then osmotically backwashed for 5 min. Over 3 d, the flux rate was reduced by about 70%, but the flux recovered fully after 5 min of osmotic backwashing. These results confirmed that it was possible for all the foulants, including the

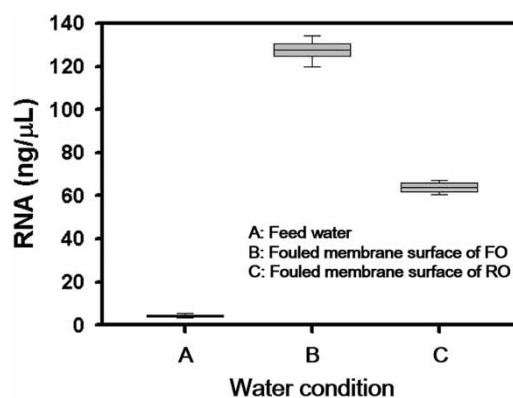

Figure 6 | Activity of microbes by analysis of RNA after fouling experiment ($n = 9$).

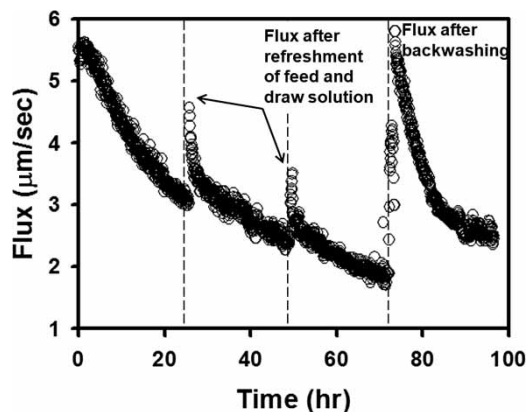

Figure 7 | Cleaning efficiency by osmotic backwashing after activated sludge fouling. Experimental conditions for fouling experiments: draw solution containing 3 M NaCl; feed solution containing activated sludge; crossflow velocity 8.5 cm/s; pH of 7.5; and temperature of 20 ± 1 °C; ($n = 2,000$).

microbes that form in the FO mode, to be controlled by osmotic backwashing.

Figure 2(c) shows the proposed membrane fouling phenomenon and the physical cleaning tendency with regard to the biofouling in FO (without hydraulic pressure) and RO (without hydraulic pressure) processes. More compression is expected to occur on the cake layer of the membrane surface in RO than in FO. In addition, the RO membrane surface is expected to have high-pressure environments for the growth and extension of microbes than the FO membrane surface, and the FO membrane surface is expected to have low-pressure environments for the growth and extension of microbes because of the less-compressed cake layer. The physical cleaning removes the cake layer, including biofilm and microbes, from both FO and RO membrane surfaces (Figure 2(c)). The membrane surface in FO is expected to have a more loosely compressed cake layer than the membrane surface in RO. Therefore, the cake layer can be easily removed through a short period of physical cleaning, and the flux can recover. On the other hand, the membrane in the RO mode is not expected to be removed easily due to the compressed cake layer.

Effect of spacer on membrane fouling

The role of spacers in FO systems for membrane fouling was investigated: the foulants were 5,000 mg/L silica particles (diameter 1–5 µm) and 200 mg/L humic acid in DI water.

Figure 8 shows the results of the spacer effect on the fouling of membrane surface for 20 h with respect to the flux. Figures 8(a) and 8(b) show the results of evaluation of spacer effect on particle fouling using silica particles (5,000 mg/L) and organic fouling using humic acid (200 mg/L), respectively. The effects of the spacer on the membrane fouling were not significant in either experiment, and the FO with the spacer slightly improved the flux of FO. Therefore, there was no significant difference between systems with or without the spacer for feed water containing silica particles or humic acid. Kim *et al.* (2014) reported that the flux decline when using combined organic-colloidal foulants in FO due to the synergistic effect. Therefore, the flux decline could be different when a mixture of humic acid and silica particles is used as foulant. Moreover, both experiments were conducted in DI water with synthetic foulants;

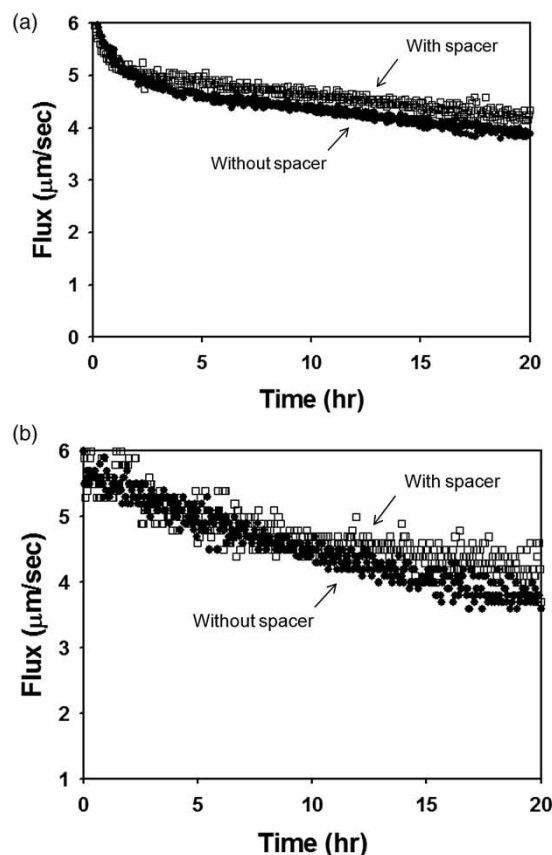

Figure 8 | The spacer effect on the fouling on the membrane surface with silica particle fouling (a) and colloidal organic (humic acid) fouling (b) in FO. Draw solution 3 M NaCl; cross-flow velocity 17 cm/sec.

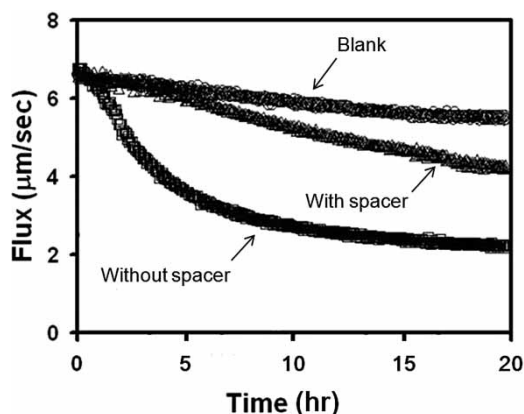

Figure 9 | The spacer effect on the fouling of FO membrane using activated sludge (MLSS 2,500 mg/L) ($n = 400$). Draw solution 3 M NaCl; cross-flow velocity 17 cm/sec.

therefore, it was also necessary to test whether the spacer could affect the performance of FO in MBR systems using activated sludge.

Figure 9 shows the spacer effect on the fouling of FO membrane using activated sludge of MLSS 2,500 mg/L: water flux decreased rapidly without the spacer but decreased gradually with a spacer, and the gradient flux decrease with a spacer was significantly different. Therefore, membrane fouling was influenced by the spacer in FO-MBR systems. However, further research needs to be carried out to determine how FO membrane performance is influenced by the spacer geometry and the role of the spacer at different MLSS concentrations. MBR systems often run under high concentrations of MLSS 2,500 to 10,000 mg/L; therefore, the effect of the spacer could be different.

CONCLUSIONS

The flux of RO for activated sludge and secondary effluent in a wastewater treatment plant was only half that for FO. The removal efficiency of RO for TN, NH₄-N and TP was lower than that of FO in the same initial flux conditions. Microbe activity, as measured by RNA, for FO was about double that for RO, and the biofouling could be more significant in FO than that in RO. However, the membrane fouling in FO was lower than that in RO, as shown in the flux reduction. A number of physical cleaning methods were compared in order to discover the most effective cleaning method to

restore the performance of FO. For the air-scouring method, there was a rapid improvement in the cleaning, but osmotic backwashing showed the highest cleaning efficiency. After a long period of fouling with activated sludge, the flux can be fully recovered in a short period of osmotic backwashing. Osmotic backwashing resulted in the most effective flux recovery in FO-MBR. However, a combination of osmotic backwashing and surface backwashing should be investigated future research since the synergy between the two methods may further improve the performance of FO-MBR. The spacer increased the flux in FO with MLSS of 2,500 mg/L, and there were some effects from the spacer on performance of the FO-MBR membrane fouling. Further studies are required to determine how the spacer geometry influences the performance of FO membrane.

ACKNOWLEDGEMENTS

The authors would like to thank Ministry of Environment and Korea Environmental Industry & Technology Institute, Eco-Innovation Program (Environmental Research Laboratory 414-111-011) for supporting this study.

REFERENCES

- Achilli, A., Cath, T. Y., Marchand, E. A. & Childress, A. E. 2009 The forward osmosis membrane bioreactor: a low fouling alternative to MBR processes. *Desalination* **239**, 10–21.
- Ang, W. L., Mohammad, A. W., Hilal, N. & Leo, C. P. 2015 A review on the applicability of integrated/hybrid membrane processes in water treatment and desalination plants. *Desalination* **363**, 2–18.
- APHA 1999 *Standard Methods for the Examination of Water and Wastewater*, 20th edn. APHA, Washington, DC.
- Cath, T. Y., Adams, V. D. & Childress, A. E. 2005a Membrane contactor processes for wastewater reclamation in space. II. Combined direct osmosis, osmotic distillation, and membrane distillation for treatment of metabolic wastewater. *J. Membr. Sci.* **257**, 111–119.
- Cath, T. Y., Gormly, S., Beaudry, E. G., Adams, V. D. & Childress, A. E. 2005b Membrane contactor processes for wastewater reclamation in space. I. Direct osmotic concentration as pretreatment for reverse osmosis. *J. Membr. Sci.* **257**, 85–98.

- Cath, T., Childress, A. & Elimelech, M. 2006 Forward osmosis: principles, applications, and recent developments. *J. Membr. Sci.* **281**, 70–87.
- Cornelissen, E., Harmsen, E., de Korte, E., Ruiken, C., Qin, J., Oo, H. & Wessels, L. 2008 Membrane fouling and process performance of forward osmosis membranes on activated sludge. *J. Membr. Sci.* **319**, 158–168.
- Costa, A. R., Pinho, M. N. & Elimelech, M. 2006 Mechanisms of colloidal natural organic matter fouling in ultrafiltration. *J. Membr. Sci.* **281**, 716–725.
- Fairbrother, F. & Mastin, H. 1924 Studies in electro-endosmosis. Part I. *J. Chemical Soc.* **125**, 2319–2330.
- Hong, S. K. & Elimelech, M. 1997 Chemical and physical aspects of natural organic matter (NOM) fouling of nanofiltration membranes. *J. Membr. Sci.* **132**, 159–181.
- Jiang, T., Kennedy, M. D., Meer, W. G. J., Vanrolleghem, P. A. & Schippers, J. C. 2003 The role of blocking and cake filtration in MBR fouling. *Desalination* **157**, 335–343.
- Kim, J., Chang, I., Shinb, D. & Park, H. 2008 Membrane fouling control through the change of the depth of a membrane module in a submerged membrane bioreactor for advanced wastewater treatment. *Desalination* **231**, 35–43.
- Kim, C., Lee, S. & Hong, S. 2012 Application of osmotic backwashing in forward osmosis: mechanisms and factors involved. *Desalination Water Treat.* **43**, 314–322.
- Kim, Y., Elimelech, M., Shon, H. K. & Hong, S. 2014 Combined organic and colloidal fouling in forward osmosis: fouling reversibility and the role of applied pressure. *J. Membr. Sci.* **460**, 206–212.
- Kravath, R. E. & Davis, J. A. 1975 Desalination of seawater by direct osmosis. *Desalination* **16**, 151–155.
- Lee, S. & Elimelech, M. 2006 Relating organic fouling of reverse osmosis membranes to intermolecular adhesion forces. *Environ. Sci. Technol.* **40**, 980–987.
- Lee, S., Boo, C., Elimelech, M. & Hong, S. 2010 Comparison of fouling in forward osmosis (FO) and reverse osmosis (RO). *J. Membr. Sci.* **365**, 34–39.
- Li, Q. & Elimelech, M. 2004 Organic fouling and chemical cleaning of nanofiltration membranes: measurements and mechanisms. *Environ. Sci. Technol.* **38**, 4683–4693.
- Lutchmiah, K., Verliefde, A. R. D., Roest, K., Rietveld, L. C. & Cornelissen, E. R. 2014 Forward osmosis for application in wastewater treatment: a review. *Water Res.* **58**, 179–197.
- Luxbacher, T. 2006 Electrokinetic characterization of flat sheet membranes by streaming current measurement. *Desalination* **199**, 376–377.
- Marmur, A. 1996 Equilibrium contact angles: theory and measurement. *Colloid. Surface. A* **116**, 55–61.
- McCutcheon, J. R., McGinnis, R. L. & Elimelech, M. 2005 A novel ammonia–carbon dioxide forward (direct) osmosis desalination process. *Desalination* **174**, 1–11.
- McCutcheon, J., McGinnis, R. & Elimelech, M. 2006 Desalination by ammonia–carbon dioxide forward osmosis: influence of draw and feed solution concentrations on process performance. *J. Membr. Sci.* **278**, 114–123.
- Mi, B. & Elimelech, M. 2008 Chemical and physical aspects of organic fouling of forward osmosis membranes. *J. Membr. Sci.* **320**, 292–302.
- Mi, B. & Elimelech, M. 2010 Organic fouling of forward osmosis membranes: fouling reversibility and cleaning without chemical reagents. *J. Membr. Sci.* **348**, 337–345.
- Ngo, H. & Guo, W. 2009 Membrane fouling control and enhanced phosphorus removal in an aerated submerged membrane bioreactor using modified green bioflocculant. *Biores. Technol.* **100**, 4289–4291.
- Phuntho, S., Lotfi, F., Hong, S., Shaffer, D. L., Elimelech, M. & Shon, H. K. 2014 Membrane scaling and flux decline during fertiliser-drawn forward osmosis desalination of brackish groundwater. *Water Res.* **57**, 172–182.
- She, Q., Wang, R., Fane, A. G. & Tang, C. Y. 2016 Membrane fouling in osmotically driven membrane processes: a review. *J. Membr. Sci.* **499**, 201–233.
- Shon, H., Vigneswaran, S. & Cho, J. 2008 Comparison of physico-chemical pretreatment methods to seawater reverse osmosis: detailed analyses of molecular weight distribution of organic matter in initial stage. *J. Membr. Sci.* **320**, 151–158.
- Valladares Linares, R. V., Li, Z., Yangali-Quintanilla, V., Li, Q. & Amy, G. 2013 Cleaning protocol for a FO membrane fouled in wastewater reuse. *Desalination Water Treat.* **51**, 4821–4824.
- Vrijenhoek, E. M., Hong, S. & Elimelech, M. 2001 Influence of membrane surface properties on initial rate of colloidal fouling of reverse osmosis and nanofiltration membranes. *J. Membr. Sci.* **188**, 115–128.
- Zhang, W., Luo, J., Ding, L. & Jaffrin, M. Y. 2015 A review on flux decline control strategies in pressure-driven membrane processes. *Ind. Eng. Chem. Res.* **54**, 2843–2861.

First received 15 January 2016; accepted in revised form 8 April 2016. Available online 31 May 2016