

Enhancement of overloaded waste stabilization ponds using different pretreatment technologies: a comparative study from Namibia

Jochen Sinn and Susanne Lackner 

ABSTRACT

Waste stabilization ponds (WSP) are a well-established wastewater treatment technology in Namibia. However, they are often overloaded and we still lack concepts and technologies for improvement. Therefore, this study presents the full-scale implementation of two pretreatment technologies to reduce the inflow of organic and solid loads into a facultative pond. We specifically compared the effects of anaerobic biological and mechanical pretreatment by an upstream anaerobic sludge blanket (UASB) reactor and a 250 μm micro sieve (MS). Not only in Namibia but also in most sub-Saharan countries, there is little experience with these technologies for the treatment of municipal wastewater in small and fast-growing local communities. Both technologies were tested in parallel for a period of 17 months and proved operational. While the UASB achieved better removal results with respect to chemical oxygen demand (COD) and suspended solids (TSS), the MS was more flexible in handling changing inflow patterns and had a much smaller footprint. The average total COD reductions of the MS and the UASB were 22 and 50%, respectively. TSS were removed by 45% with the MS and by 57% with the UASB reactor. Therefore, UASB and MS are viable options for the enhancement of existing WSP to reach better effluent values of the facultative pond.

Key words | agricultural reuse, developing country, load reduction, micro sieve, UASB, waste stabilization ponds

HIGHLIGHTS

- Extensive data acquisition at waste stabilization ponds (WSP) in sub-Saharan Africa.
- Load reduction for WSP enhanced by UASB and micro sieve.
- First application of an UASB reactor before WSP in the sub-Saharan context with peak pCOD removal of 89%.
- First application of a 250 μm micro sieve as pretreatment for municipal wastewater before WSP with a maximum 72% of pCOD reduction.
- Pilot project for many other WSP in Namibia and other countries, especially in Africa.

Jochen Sinn

Susanne Lackner  (corresponding author)

Department of Civil and Environmental

Engineering Sciences, Institute IWAR, Chair of

Wastewater Engineering,

Technical University of Darmstadt,

Franziska-Braun-Strasse 7, 64287 Darmstadt,

Germany

E-mail: s.lackner@iwar.tu-darmstadt.de

This is an Open Access article distributed under the terms of the Creative Commons Attribution Licence (CC BY 4.0), which permits copying, adaptation and redistribution, provided the original work is properly cited (<http://creativecommons.org/licenses/by/4.0/>).

doi: 10.2166/wrd.2020.021

GRAPHICAL ABSTRACT

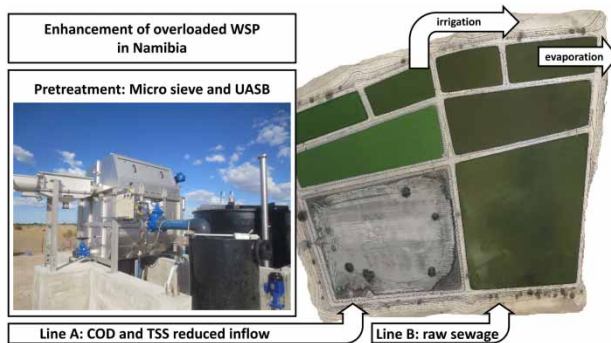

INTRODUCTION

Water scarcity has become an increasing struggle in many regions worldwide. Recent variable weather conditions in sub-Saharan Africa show direct effects of climate change. Most affected by variable rainfall or lack of any precipitation are farmers who need the precipitation for their crops. Therefore, water reuse of treated wastewater is becoming an ever more important mitigation measure. [Mara \(2009\)](#) already postulated the increasing need for reuse of treated municipal wastewater, from e.g. waste stabilization ponds (WSP), in water scarce areas. However, in many towns with sewer systems, the only wastewater treatment systems, if any, are WSP. They require low maintenance and power requirements but are often too small and overloaded due to the very high population growth.

With the combination of extended drought periods due to climate change and increasing water demand, the focus is shifting more and more towards water reuse, e.g. for irrigation. Thereby, WSP face new challenges. They have to fulfil national or international water quality standards, especially for hygienic parameters but also for COD removal. Not only the increasing population and the related need for more irrigation water with valuable nutrients but also the reduction of greenhouse gases impose a growing burden on WSP ([Shelef & Azov 2000](#); [Hernandez-Paniagua et al. 2014](#)). A typical strategy for capacity enhancement is volume extension (number and or size of the ponds) which is accompanied by growing land requirements.

Other options may present themselves through upgrades of existing WSP with more advanced treatment technologies, such as anaerobic biological or mechanical treatment units.

This study compares an upstream anaerobic sludge blanket (UASB) reactor to a micro sieve (MS) as potential pretreatment technologies in order to reduce the load of organic carbon (measured as chemical oxygen demand, COD) and suspended solids entering an existing overloaded WSP in Northern Namibia. The potential of these technologies to reduce COD and solids has been reported by [Lazarova & Bahri \(2005\)](#) with a wide range of values of 40–70% and 20–75% for UASB and MS, respectively. Also, the effect of such measures on the performance of consecutive ponds has not been monitored in depth in any sub-Saharan countries.

Due to high COD and TS loads into primary facultative ponds, sludge accumulation is also an issue and reduces the treatment capacity. A typical WSP set-up would include an anaerobic pond to reduce COD and TSS loads into the facultative pond ([Shilton 2005](#); [Sperling 2007](#)). However, this would not reduce potential methane emissions and would not solve the problem of the quickly accumulating sludge. In order to address this, UASB reactors have already been installed as anaerobic biological pretreatment of municipal wastewater in front of WSP in other countries (e.g. in Brazil or India) with similar climate conditions ([Frassinetti et al. 1996](#); [Khan et al. 2011](#); [Dias et al. 2017](#); [Bressani-Ribeiro et al. 2019](#); [Vassalle et al. 2020](#)). Only [Müller \(2017\)](#) already

examined UASB reactors before rotating biological contactors (RBC) in Namibia.

At the same time, mechanical pretreatment with micro sieves is becoming increasingly more important for energy recovery (Rusten & Ødegaard 2006; Prösl *et al.* 2013; Paulsrud *et al.* 2014; Walder *et al.* 2015; Hey *et al.* 2016; Jahn *et al.* 2017). In Europe, Jahn *et al.* (2017) and Walder *et al.* (2015) researched an MS within the Austrian context. In Namibia, micro sieves have so far been implemented as pretreatment for an industrial wastewater treatment plant followed by membrane bio-reactors (Prösl *et al.* 2013) and as post-treatment for a municipal wastewater treatment plant (Müller 2017). An MS for the pretreatment before a WSP, however, has been implemented for the first time in this research.

This is the first study which compares a UASB reactor (biological pretreatment) with an MS (mechanical pretreatment) to relieve overloaded WSP, with Namibia as an example. The results are especially important for fast-growing communities in warm climates with the need of water reuse for irrigation and for regions without perennial streams (Butler *et al.* 2017).

MATERIAL AND METHODS

WSP and pretreatment technologies

This project was conducted at an existing WSP system in a regional capital in Northern Namibia. The original WSP system as planned in 2004, consisted of two parallel lines (line A and line B) with four ponds each (Figure 1): one primary facultative pond (1) and three maturation ponds

(ponds 2–4) (Supplementary material, Figure S1). According to the design, the feed rhythm alternated between the two lines. The two facultative ponds have the largest volume of 16,000 m³ each and a surface of 11,000 m². Both are followed by three maturation ponds with smaller surfaces and volumes. The total water surface of the WSP is 40,500 m² with a total volume of 53,000 m³. The water level decreases from 1.5 m in the first pond to 1.1 m in the last pond (Supplementary material, Table S1). Due to a high groundwater table and a nearby ephemeral stream, the earth dams constructed above the natural surface are covered with concrete, while the ground of the ponds is lined with clay.

Two pretreatment technologies were tested: an MS and an UASB reactor. Upfront, a coarse screen with 0.01 m bar spacing followed by a 56 m³ open collection chamber to buffer peak inflows was installed (Figure 1). The pretreatment technologies for the upgrade were installed in line A. The UASB reactor had a volume of 42 m³ and was continuously fed with 3–4 m³/h inflow of raw wastewater, resulting in a hydraulic retention time of 10–14 h. In parallel, an MS (Noggerath Rotary Drum Screen RSJ-MG[®]) with a 250-µm monodur polyamide mesh was installed. Its drum diameter was 1.6 m, with a length of 1.5 m, resulting in a total area of 7.5 m². Aside from the standard monitoring, a 2-week intensive testing phase was carried out from day 265 to day 275. During this period, different flows and operational settings were applied. These included an increasing inflow from 28 to 60 m³/h (maximum capacity of the feed pump: 75 m³/h), an increase of the impounding depth from 10 to 18 cm and chemical cleaning with a 2% potassium hydroxide solution at 60 °C.

Additionally to the pretreatment, pond A1 was renewed by emptying out the settled sludge and installing two floating

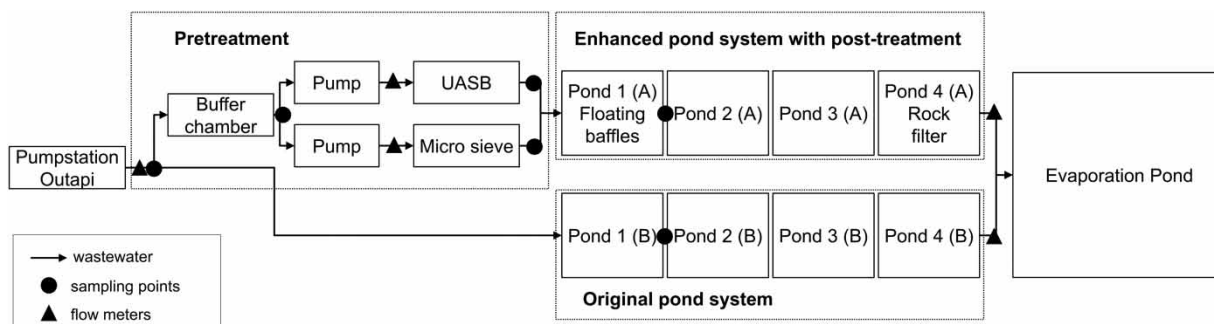

Figure 1 | Schematic drawing of the water reuse project, the black dots represent sampling points.

baffles made of 2-mm thick HDPE (high density polyethylene) sheets down to the full depth over two-thirds of its length. This improvement now avoids short-circuiting and enables better plug flow conditions. The overall project also includes the installation of a rock filter in pond A4 as post-treatment. The focus of this work was, however, on the pretreatment technologies only. These were continuously monitored for 17 months. Due to pump failure after heavy rainfalls with inundations and power failures, the MS had 88 days standstill time from day 110 to day 198.

Sampling and analyses

Electromagnetic flowmeters measured the inflow to the plant, the inflow to the UASB reactor, and the MS, as well as the outflow of ponds A4 and B4. Wastewater quality was monitored with portable probes for pH, dissolved oxygen, and conductivity using a WTW multimeter 3410 (Xylem Analytics Germany) at different sites: untreated wastewater, the effluents of UASB, MS, and A1 and B1 (Figure 1).

Due to high retention times in the sewer system with 15 pump sumps and in the ponds, grab samples were taken at different times of the day. For the untreated wastewater also 2-h mixed samples were analysed for comparison. The samples were analysed regularly with Hach Lange LCK cuvette tests for COD, total nitrogen (TN) ammonium, nitrite, nitrate, total phosphorus (TP), and phosphate with a spectrophotometer DR 2800 (Hach Lange GmbH, Germany). Indicator bacteria were examined with IDEXX Colilert-18 (enumeration of total coliforms and *Escherichia coli*) and Enterolert (*Enterococci*) employing Quanti-Tray/2000 (IDEXX Germany). To obtain total solids (TS) and total suspended solids (TSS), the samples were dried at 105 °C and for TSS also filtered with glass microfiber filters (Whatman 934-AH). Total volatile solids (TVS) and volatile suspended solids (VSS) were measured after ignition at 550 °C. The UASB reactor had five outlets to determine the level of the sludge bed.

RESULTS AND DISCUSSION

Site development in Outapi

Originally about 2,500 of 3,000 inhabitants were connected to the sewer system, and the pond system treated their

wastewater. By 2018, the connected population had almost tripled up to nearly 7,000 people. However, due to the high population growth rate of 9.3% per annum, the total population in 2018 was estimated at 12,000 (Mwinga *et al.* 2018). This resulted in only 58% of the total population discharging their wastewater to the sewer and wastewater treatment system, while 69% were connected to the town's water supply system (Mwinga *et al.* 2018).

The WSP were designed with no overflow to the surrounding ephemeral watercourse, so that all water was supposed to evaporate. Already at the early stage of operation, an additional evaporation pond with a surface area of 41,000 m² and a volume of 20,500 m³ (Supplementary material, Figure S1 and Table S1) was built with simple earth dams. However, due to higher flow rates, especially during the rainy season, the evaporation pond was overflowing regularly, posing a potential health risk to humans and grazing animals.

Within this study, enhancement measures at the existing WSP with simple pre- and post-treatment technologies were introduced and tested in order to improve the effluent quality and thereby ensure safe water reuse for irrigation of fodder crops. For comparison, one line (line B) kept its original status of 2004, while the other line (A) was enhanced.

Inflow characteristics

In this study, wastewater characteristics were monitored extensively for a long period of time. Such detailed information has so far not been available for the sub-Saharan context. The collected data included water quality parameter as well as flow patterns.

The mean total inflow to the WSP was 802 (± 177) m³/d during the observation period, with a peak inflow of 1,330 m³/d on day 267 (Supplementary material, Figure S2). The maximum inflow was reached after rainfall events due to surface water entering the sewer system. Compared to preceding years, there was hardly any rain in the region during summer. This is also an indicator of changing rain patterns. In comparison, previous years recorded the highest hydraulic inflow to the plant with almost 2,000 m³/d after heavy rainfalls.

Over the past years, the mean daily inflow has increased from 710 m³/d in 2016 to 811 m³/d in 2018. This 14%

increase over 2 years very well reflects the growth of the town and more connections to the sewer system. The peak inflow to the WSP was in the morning between 6 and 11 am. Three typical inflow patterns are presented in Supplementary material, Figure S3. After the peak in the morning, there was a second increase towards the early evening followed by reducing values during the night, showing rather typical daily variations in the inflow.

The inflow was divided equally between both lines for the purpose of good comparison between the enhanced line A and the line at its original state (line B). Line A received a mean inflow of 345 (± 191) m³/d pretreated wastewater, the inflow to line B without pretreatment was 472 (± 211) m³/d (Figure 2).

The water quality of the raw wastewater is included in Supplementary material, Table S2. Mean loads and concentrations of 606 (± 149) kg/d and 749 (± 153) mg/L for tCOD, 61.7 (± 15.4) kg/d and 76.0 (± 12.5) mg/L for TN, 8.0 (± 1.7) kg/d and 9.8 (± 1.3) mg/L for TP, and 174 (± 67) kg/d and 220 (± 81) mg/L for TSS were observed. These values are within a common range for municipal wastewater (Tchobanoglous & Abu-Orf 2014).

Pretreatment technologies

Two different pretreatment technologies, a biological system relying on anaerobic degradation processes (UASB) and a mechanical treatment system (MS) were monitored in parallel to evaluate their potential for reducing the COD and solids load into the WSP. Besides the settling of the pCOD and the TSS in the UASB, anaerobic microorganisms also reduced sCOD, nutrients, and pathogens. In comparison,

the MS used a solely mechanical sieving process to reduce pCOD and TSS. The continuous operation of the UASB required a larger buffer volume to compensate for peak inflows, while the MS was very flexible with changing flow patterns.

Over the course of the research period, the MS received on average 357 (± 152) m³/d and the UASB 60 (± 33) m³/d. Changing treated volumes depended on the total inflow fluctuation and peak times as well as on the pump capacities. Peak inflows were 235 m³/d for the UASB and 873 m³/d for the MS.

Micro sieve

The different operation phases of the MS are indicated in Figure 3. The commissioning (day 1 to day 43) with unstable COD effluent values was followed by a stable operation phase. Effluent concentrations of the MS from day 77 to day 109 were tCOD 676 (± 24) mg/L, pCOD 370 (± 26) mg/L, and sCOD 304 (± 14) mg/L. After the standstill (day 110 to day 199), the operation was less stable but improved towards the end of the study period with concentrations for tCOD of 708 (± 132) mg/L, pCOD = 404 (± 133) mg/L, and sCOD = 293 (± 68) mg/L. Over the whole study period (day 1 to day 527), the mean sCOD concentrations with 306 (± 58) mg/L were more constant than the tCOD concentrations with 740 (± 142) mg/L and pCOD = 431 (± 128) mg/L.

Over the whole study period, the tCOD removal was 22 (± 18)% and pCOD removal was 28 (± 24)%. Therefore, the installed MS reached good percentage removal which was within the range of others, e.g. the 15–25% tCOD removal

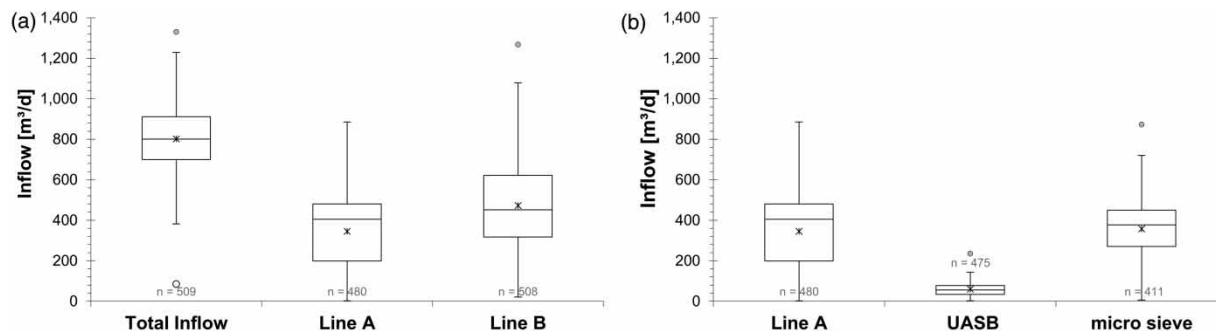

Figure 2 | Daily flow rates (total inflow, line A and B, UASB, and MS) from day 1 to day 527.

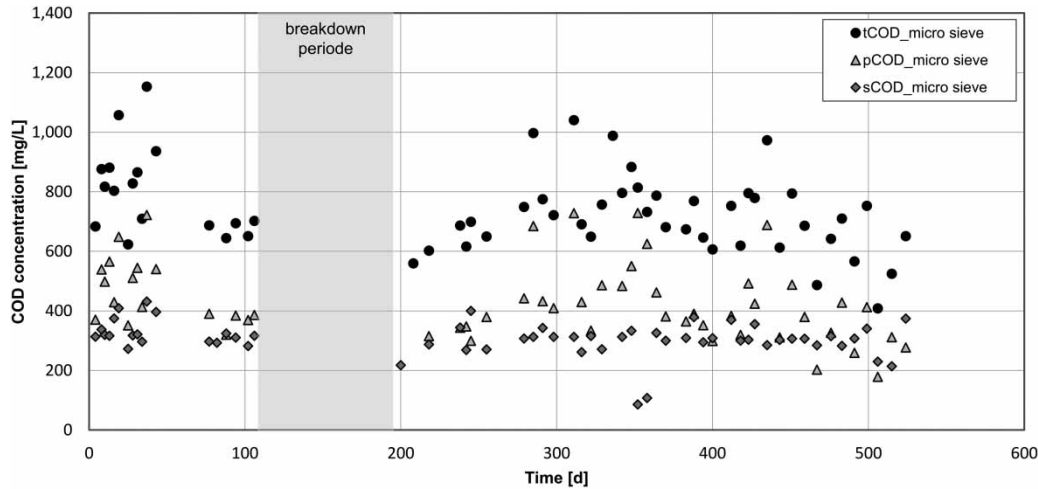

Figure 3 | COD effluent concentrations of the MS (tCOD: total COD, pCOD: particulate COD, and sCOD: soluble COD). The grey area indicates the breakdown period.

reported by Lazarova & Bahri (2005) or the 25% removal reported by Prösl *et al.* (2013). Elimination efficiencies of up to 40% tCOD seem only reachable with flocculation (Walder *et al.* 2015; Jahn *et al.* 2017). Peak tCOD and pCOD removal reached up to 57 and 72%, respectively. At the same time, the sCOD was hardly reduced as expected.

On the contrary, TSS removal reached $45 (\pm 27)\%$ over the whole study period. The removal of VSS was in the same range as $48 (\pm 22)\%$. These values are better than at an industrial wastewater treatment plant in Windhoek. There, the two MS for the mechanical pretreatment also operate with $250 \mu\text{m}$ sieves and remove only 30% of TSS (Prösl *et al.* 2013). Sieves in Austria reached a removal of 65% with flocculation (Walder *et al.* 2015; Jahn *et al.* 2017). Our MS reached similar levels as the ones in Austria only during 3 days for its peak performance, which showed a maximum removal of 80% (TSS)

and 82% (VSS), respectively. Therefore, the original design value of the manufacturer with an average of 60% TSS removal can only be reached with flocculation.

The intensive 2-week testing phase revealed that with the increasing inflow, the spray time over the cycle time in-between two cleaning events increased linearly (Figure 4(a)). Hence, the maximum theoretical inflow of the tested MS would be about $100 \text{ m}^3/\text{h}$. This, however, would require a constant spray operation which is not practical. Therefore, a maximum spray time of 80% of the cycle time was chosen which yielded a maximum inflow of $83 \text{ m}^3/\text{h}$. This compares very well with the maximum design value of $82 \text{ m}^3/\text{h}$. Based on the total sieve surface of 7.5 m^2 , the maximum hydraulic loading rate of $11 \text{ m}^3/(\text{m}^2 \text{ h})$ can be reached. This value is within the same range of $6\text{--}12 \text{ m}^3/(\text{m}^2 \text{ h})$ as observed in Austria (Jahn *et al.* 2017).

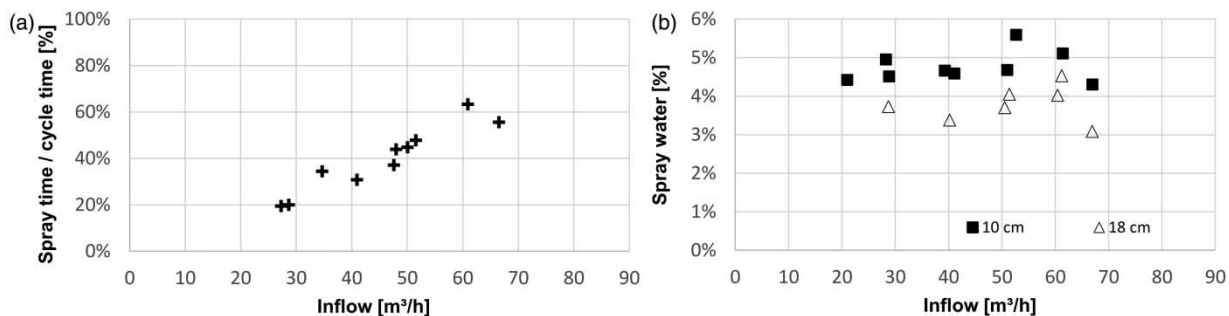

Figure 4 | Micro sieve spray time (a) in % of the cycle time and spray water consumption (b) in % of the treated water.

Another important aspect of the MS was the spray water consumption in relation to the treated wastewater flow. For a sustainable operation process, water from the MS effluent was used to spray the sieve itself instead of using valuable, high-quality tap water. Nevertheless, spray water use should be as low as possible to reduce energy consumption for the process of water pumping. This study shows that the percentage of spray water did not depend on the inflow but on the impounding depth. With an impounding depth of 10 cm, there was an average need of just below 5% while with a depth of 18 cm less than 4% was needed (Figure 4(b)). This is almost double the 2–3% measured by Walder *et al.* (2015) in Austria who have cleaned their sieve with water and a combined air injector.

UASB reactor

For the first 2 months after commissioning of the pretreatment stage, there was only a small COD reduction in the UASB reactor. Total COD was reduced by only 18% from 838 to 685 mg/L, while the sCOD remained constant at around 400 mg/L. After the inoculation of the UASB reactor with anaerobic sludge from the bottom of pond B1 on day 65, the tCOD concentration reduced over 3 months down to 234 mg/L and sCOD to 102 mg/L (Figure 5). This improvement of the performance was partially attributed to this inoculation but also to a rise in water temperature.

The temperature increased from 23.5 °C in winter (day 1 to day 30) up to 28.5 °C in summer (day 75 to day 145). The temperature influence was also evident during later periods (day 200 to day 527). During the cold season, the highest tCOD effluent was measured with 720 mg/L (day 370). However, this was also influenced by the accumulating sludge in the UASB. With regular sludge removal every 4–6 weeks from day 380 onwards, the tCOD effluent improved and reduced back down to 274 mg/L. While the tCOD was influenced by temperature and sludge accumulation, the sCOD remained constant with an average concentration of 108 mg/L after the inoculation.

The removal of tCOD was 50 (± 21)% during the whole study period. The peak removal was reached on day 311 with 84%. This is lower than the measured average values in Brazil of 63% (Dias *et al.* 2017), but close to the 57% of Vassalle *et al.* (2020). At the same time, the mean sCOD removal was 54 (± 28)%, pCOD was removed by 45 (± 29)%. Peak removals were 80% for sCOD on day 524 and 89% for pCOD (day 311).

After the inoculation of the UASB reactor with the anaerobic sludge from pond B1 on day 65, the solids in the UASB settled constantly over the following 3 months. In the beginning, the TS concentration at the top level reduced from 11 to 1.0 g/L and TVS from 7 g/L down to 0.4 g/L. At the same time, the TS concentration at the bottom level increased from 43 to 62 g/L, the TVS

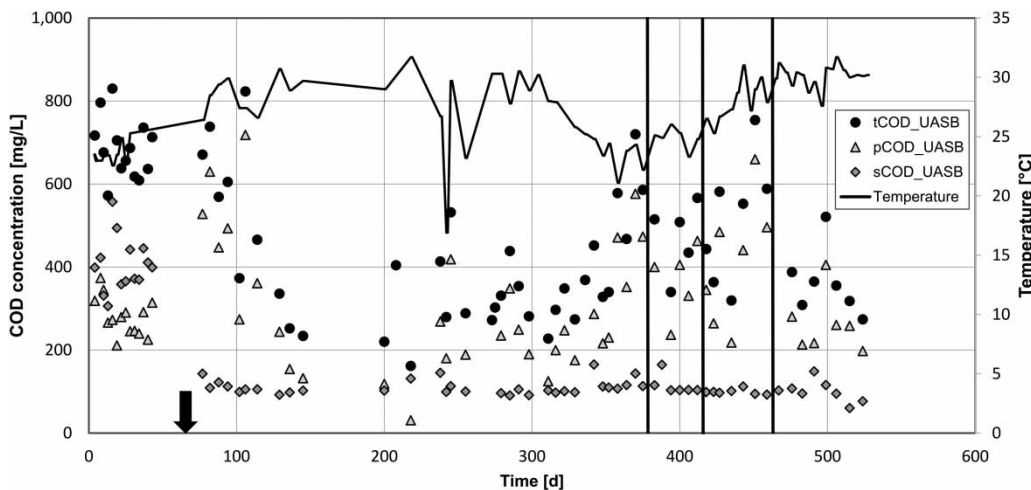

Figure 5 | COD effluent concentrations of the UASB reactor (tCOD: total COD, pCOD: particulate COD, and sCOD: soluble COD) and effluent temperature. The arrow indicates the inoculation (day 65), the black lines represent the sludge removal.

concentration from 30 to 38 g/L. After a continuous feeding period of 1 year, the first sludge was removed from the bottom layer (Figure 6). During the following months, the sludge bed was monitored and when it reached a height of 2.5 m in the reactor, between the second and third sampling level, about 5 m³ were removed. This was three times during the study period. The mean TS concentration at the bottom level was 58 g/L with a TVS content of 66%, while the top level had an average TS concentration of 3.8 g/L with a TVS content of also 66% (Supplementary material, Figure S4).

Water quality comparison

Both, UASB reactor and MS, are valuable pretreatment technologies that have been implemented in different contexts. Within the local context of this study, the direct comparison of the effluent values showed that the percentage removal of the UASB was often higher than the ones of the MS. With regards to the tCOD removal, the UASB mostly came close or above 50%, while the MS seldom achieved over 50% (Figure 7(a)). This was mainly a result of the sCOD reduction in the UASB that did not exist in the MS. For the pCOD removal, the MS delivered more values above 50% but never above 75% like the UASB did (Figure 7(b)). The average tCOD reduction of the MS was 22 versus 50% of the UASB. TSS were removed by 45% with the MS and by 57% with the UASB reactor.

Even though the main purpose of both technologies was to reduce COD and TSS loads, they also had a visible effect on the microbiology. While the MS removed up to 50% of total coliforms and *E. coli*, the UASB reached even better removal efficiencies of 50–75% for *E. coli* and even above 75% for total coliforms (Figure 7(c) and 7(d)). Negative percentage removal in all cases can be explained by washing out of biofilm that accumulated on the walls of the UASB and the MS. The UASB was less affected by detaching biofilm as this biomass generally settles with the pCOD and is removed via sludge withdrawal. For the MS, detached biofilm was easily washed out with the effluent and was, therefore, more often detected.

On average, the UASB reactor reached tCOD effluent concentrations of 477 (± 174) mg/L compared to 740 (± 142) mg/L by the MS (Figure 8(a)). This was mainly due to the additional sCOD removal of the UASB. Soluble COD effluent values for UASB and MS were 171 (± 126) and 306 (± 58) mg/L, respectively (Figure 8(b)). In addition, for the pCOD, the UASB had a better removal of 45% with an outflow of 313 (± 136) mg/L compared to 28% and 431 (± 128) mg/L for the MS (Supplementary material, Table S2).

With regard to the potential water reuse purpose for irrigation of fodder crops, nutrient removal or conservation is another important aspect to be considered. As shown in Figure 8(c) and 8(d), there was almost no removal of phosphorus and nitrogen. The effluent values for TN were very

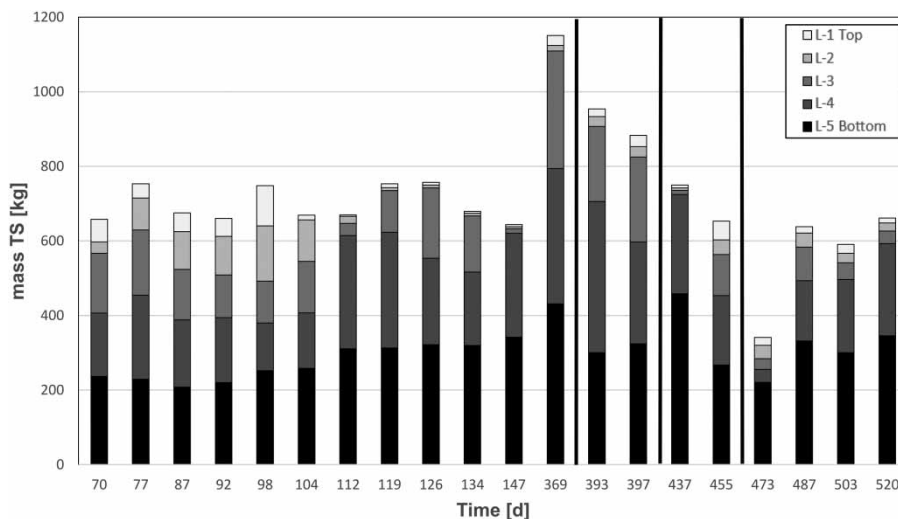

Figure 6 | Mass of total solids (TS) in the UASB in each layer L-1 Top, L-2, L-3, L-4, and L-5 Bottom with the black lines representing sludge removal.

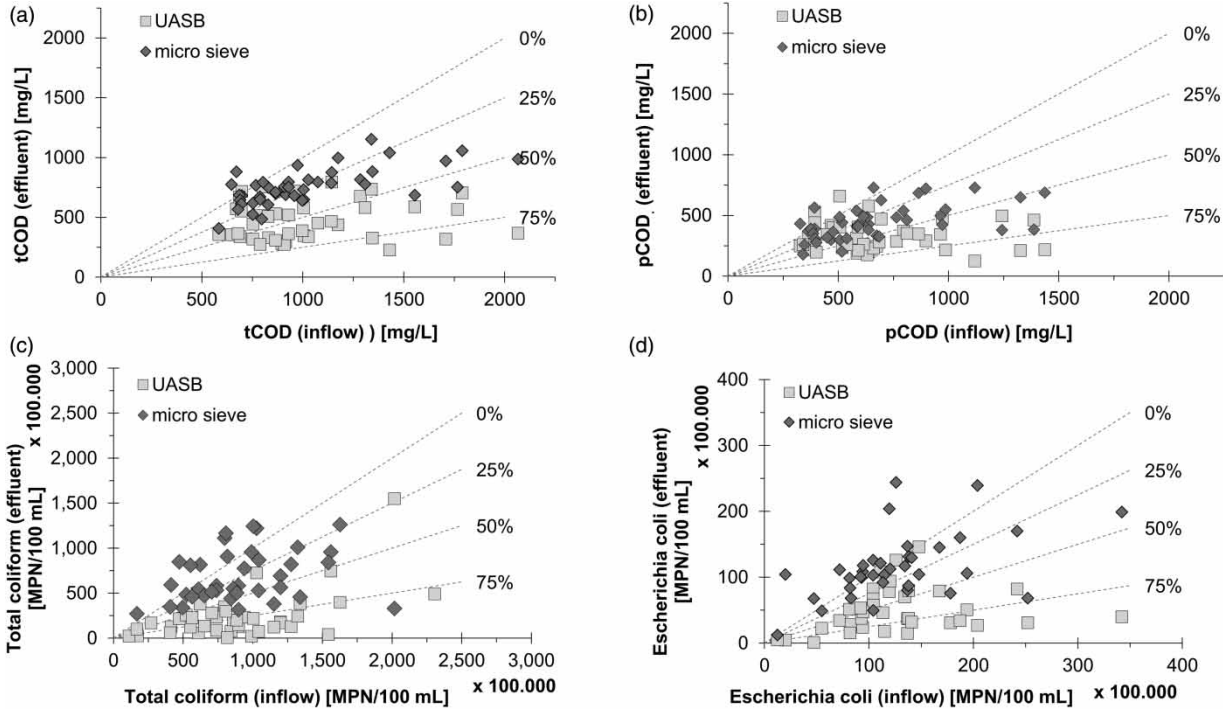

Figure 7 | Comparison of the removal percentages of MS and UASB reactor for tCOD (a), pCOD (b), total coliforms (c), and *E. coli* (d).

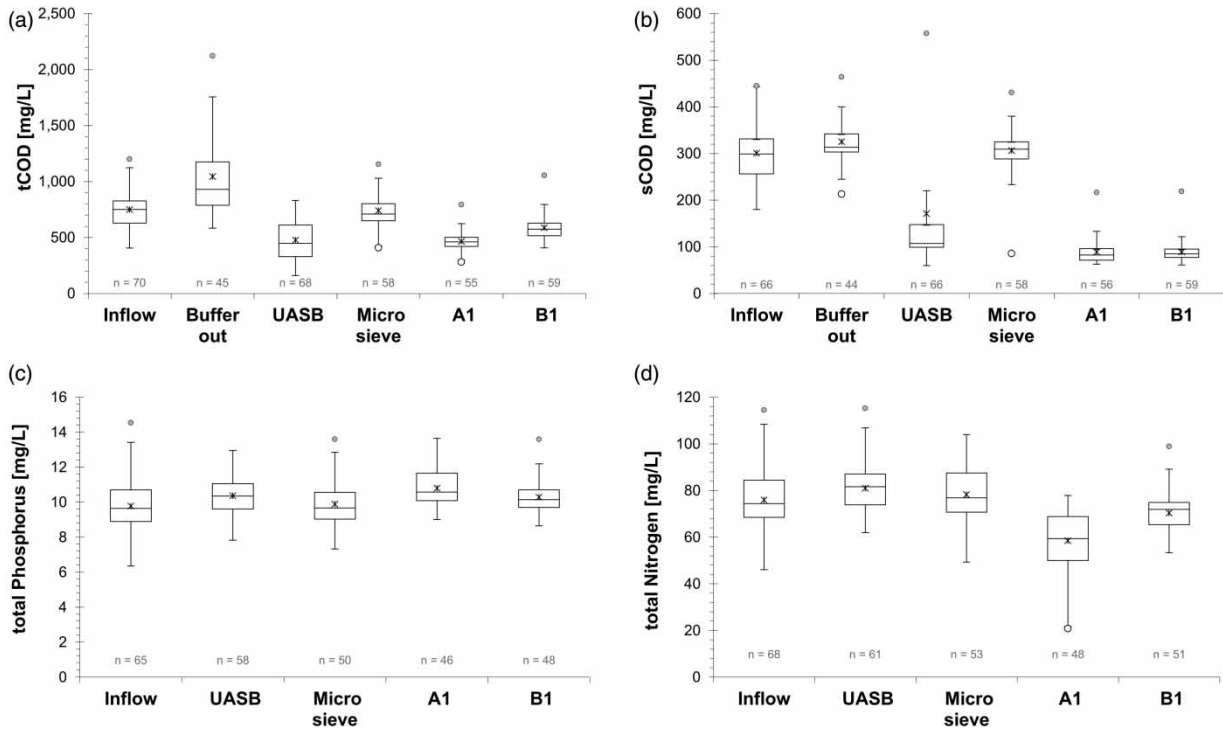

Figure 8 | Total (a) and soluble (b) COD effluent concentrations, and data for total phosphorus (TP) (c) and total nitrogen (TN) (d) concentrations of the UASB reactor, the MS, the secondary facultative pond A1, and the primary facultative pond B1.

close with 81 (± 10) mg/L for the UASB and 79 (± 12) mg/L for the MS. The same applied for TP with 10.4 (± 1.1) and 9.9 (± 1.3) mg/L, respectively. This corresponds well with findings of Dias *et al.* (2017) who measured even slight increases in total Kjeldahl nitrogen (TKN) concentrations after an UASB. Jahn *et al.* (2017) and Walder *et al.* (2015) reached 29% of TP removal and 6% of TN with their MS. However, they also implemented a flocculation process which certainly influenced the phosphorus removal.

Facultative ponds

Both first ponds were originally designed as primary facultative ponds, while pond A1 was transferred into a secondary facultative pond with the installation of the pretreatment (Shilton 2005; Sperling 2007). The floating baffles were installed into pond A1 on day 64 as a measure to optimize the flow conditions instead of potential short-circuiting existing in B1, as the last measure of three improvements. The other two main differences of this pond (A1) were the reduced inflow loads of COD and TS (due to the pretreatment) and the full available pond volume due to initial sludge removal. The total inflow into pond A1 was the combined effluent from the UASB reactor (16%) and the MS (84%), while pond B1 received 100% raw sewage.

The tCOD concentration in the effluent of pond A1 was 21% lower than that of B1 with 465 (± 93) versus 588 (± 123) mg/L, respectively (Figure 8(a)). Also, the pCOD concentrations were lower in A1 with 380 (± 92) mg/L

than in B1 with 461 (± 125) mg/L. However, the sCOD concentrations with 89 (± 28) mg/L for A1 and 89 (± 22) mg/L for B1 were the same (Figure 8(b)). This clearly showed that the enhancement of the pond system had its main impact on the removal of the pCOD.

At the same time, both ponds (A1 and B1) recorded impacts on the microbial parameters. All measured parameters indicated further but low removal. A1 had maximum one \log_{10} unit better effluent values than pond B1. For *E. coli*, it reached an average of $4.4 \times 10^{+05}$ ($\pm 6.6 \times 10^{+05}$) MPN/100 mL with B1 of $1.6 \times 10^{+06}$ ($\pm 3.2 \times 10^{+06}$) MPN/100 mL (Figure 9). Total coliforms were almost at the same level as $1.2 \times 10^{+07}$ ($\pm 1.3 \times 10^{+07}$) MPN/100 mL and $2.6 \times 10^{+07}$ ($\pm 3.8 \times 10^{+07}$) MPN/100 mL, respectively. Also for *Enterococci*, there was one \log_{10} unit difference with A1 being $8.6 \times 10^{+03}$ ($\pm 1.4 \times 10^{+04}$) MPN/100 mL and B1 being at $6.3 \times 10^{+04}$ ($\pm 4.4 \times 10^{+04}$) MPN/100 mL. Even with those low removal values, it has to be stated that disinfection was not the main task of facultative ponds. This had to be achieved by the following maturation ponds (Shilton 2005; Sperling 2007).

In order to judge the treatment capacity of the ponds, the effluent concentrations were one aspect as they are relevant for the intended irrigation purpose. However, due to high evaporation losses, those concentrations can be misleading in terms of the functionality of the system. Therefore, we also considered loads and their reduction. The mean tCOD loads at the outflow of pond A1 were 158 (± 69) kg/d with a removal efficiency of 49% compared

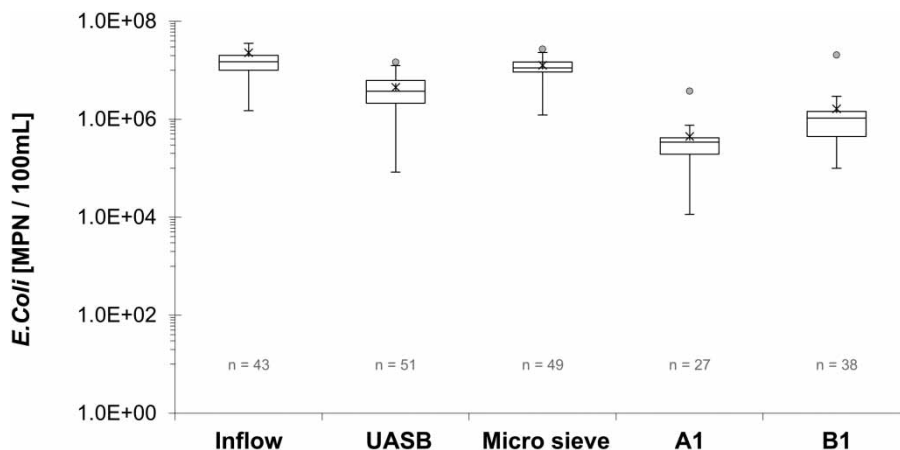

Figure 9 | *E. coli* concentrations of the inflow, the UASB reactor, the MS, and line A and B (MPN: most probable number).

to the inflow into line A. At the same time, the removal after pond B1 was only 36% with an average load of 211 (± 117) kg/d (Figure 10). For the sCOD, the removal in both lines was 77% with similar load values of 29 (± 15) kg/d for A1 and 32 (± 18) kg/d for B1. Also for TP, there was only a slightly reduced load for A1 with 3.4 (± 1.5) kg/d compared to 3.8 (± 2.0) kg/d at B1. On the contrary, the TN loads were further reduced in line A than in line B with 19 (± 9) kg/d and 26 (± 14) kg/d, respectively.

Challenges for large-scale implementation

Both technologies proved to be viable options for the pretreatment of raw sewage upfront of WSP in the sub-Saharan context. However, for the large-scale implementation of only one technology, there are certain issues that have to be considered. The UASB had better effluent values but only treated a small fraction of the total inflow. For further improvement of the inflow to pond A1 by treating the entire inflow volume with UASB, they would have to be much larger. Either a much bigger reactor or several reactors in parallel, which would be more complicated to feed and operate, have to be installed. In the local situation, the power supply was needed to operate the feed pump of the UASB. Depending on other situations, it might be possible to feed the UASB with the last sewer pump in town. In this case, proper waste removal has to be ensured at the last pump station. Besides the reactor itself, dry beds are needed for the handling of excess sludge. They have to be designed according to the size of the reactor and the expected sludge accumulation. In order to reduce climate gas emissions, methane has to

be transformed into CO_2 . This can be either achieved with a flare as in this study or, if higher volumes of CH_4 are produced, with a combined heat and power system. This would also have a positive effect on the energy consumption of the plant. Another consideration for the implementation of a system with UASB reactors is the local temperature. During hot seasons, the removal efficiencies were considerably better, and therefore, it has to be ensured that also during colder periods the effluent values are reached.

In areas with long cold periods, the pretreatment with an MS might be a better option as the temperature has no influence on the MS. However, the constant power supply is necessary for the operation of the MS as well as for the spray water pump. If process water is used for spraying, a buffer tank is required, so that tap water consumption can be reduced. At the same time, the MS was flexible with changing inflow peaks and volumes. The one MS would be able to treat the full inflow as the only pretreatment technology. Nevertheless, regular maintenance such as cleaning of the sieves and replacement of spare parts is necessary, which can be difficult to acquire in the region. Also, further treatment of the sieving residue is required. Ideally, this is done with a fermentation process, so that the produced biogas can be transferred into power. Alternatively, the residue can be composted and after stabilization and drying used as fertilizer.

During the research period, operation and maintenance were conducted jointly by project partners, students, and the local Namibian plant operators. They were trained during the implementation of the project and are afterwards capable of sustaining the required daily works.

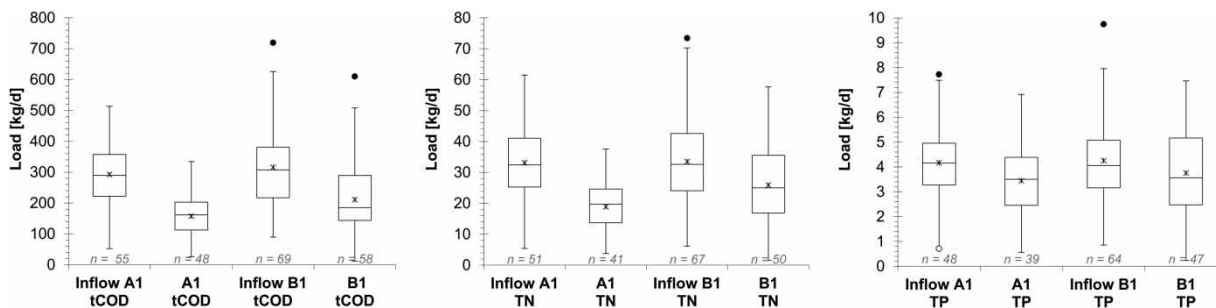

Figure 10 | Reduction of tCOD, TN, and TP loads over the treatment line.

CONCLUSIONS

In this study, two different pretreatment technologies were compared for the enhancement of overloaded WSP in Africa, also providing a detailed dataset of wastewater characteristics and effluent qualities. This full-scale research proved that both UASB reactor as well as MS are capable of reducing COD and TSS from the raw wastewater in the local context of warm climates, especially if there are space restrictions for further extensions. However, with the technical enhancement of existing WSP, the requirements increase. This means that regular power supply is needed for the MS, and it would be a benefit for the operation of the UASB reactor. Secondly, more maintenance for pumps and machinery will be necessary. At the same time, this improves the approach of the operators, who might have interpreted WSP as maintenance-free. Thirdly, spray water is necessary to clean the sieve. Ideally, this is implemented through a recirculation system of process water. Water consumption could be further reduced with a combined air and water cleaning.

The reduction of COD and solid loads into the first pond was achieved by both technologies with better effluent values of the UASB. However, the MS was more flexible with changing inflows and large volumes. The UASB further reduced sCOD, pathogens, and small amounts of nutrients, which is beneficial for further treatment with ponds but not strictly required. In contrast, phosphorus and nitrogen are valuable nutrients for the projected irrigation. Little to no removal of TN and TP was observed with the pretreatment, only later small amounts were consumed by algae and therefore remained in the system and were available for further irrigation purposes.

A positive effect of sludge removal, pretreatment, and baffles in line A was evident by better effluent values from A1 than with the unimproved pond B1. A further benefit of the pretreatment will be lower sludge accumulation rates and therefore longer removal intervals. Further research will focus in detail on the effluent values of ponds A4 and B4 and the suitability of the water quality for irrigation purposes. Such research will also include the maturation ponds and especially the influence of algae on the irrigation water as well as the disinfection and reduction

capacity for pathogens. Long-term performance and operation stability data of UASB and MS will also be available for this local context.

ACKNOWLEDGEMENTS

This research was conducted within the joint research project EPoNa (grant number 02WAV1401A-F), which was funded by the German Federal Ministry of Education and Research under the funding measure Future-oriented Technologies and Concepts to Increase Water Availability by Water Reuse and Desalination – WavE. We would like to thank Peter Cornel for his support with micro sieve testing and for valuable discussions of the results. We would also like to thank Emanuel Döser, Andrea Friebe, Mikael Hidulika, Sven Jarczok, Lydia Luvunga, Haikela Nahambelelwe, Jöran Nguyen, Jakob Rauch, and Marcel Reusing for their support with regular sampling and water quality analyses; and the Outapi Town Council (OTC) for their support and the access to their facilities.

DATA AVAILABILITY STATEMENT

All relevant data are included in the paper or its Supplementary Information.

REFERENCES

- Bressani-Ribeiro, T., Chamhum-Silva, L. A. & Chernicharo, C. A. L. 2019 [Constraints, performance and perspectives of anaerobic sewage treatment: lessons from full-scale sewage treatment plants in Brazil](#). *Water Science and Technology* **80** (3), 418–425.
- Butler, E., Hung, Y.-T., Suleiman Al Ahmad, M., Yeh, R. Y.-L., Liu, R. L.-H. & Fu, Y.-P. 2017 [Oxidation pond for municipal wastewater treatment](#). *Applied Water Science* **7** (1), 31–51.
- Dias, D. F. C., Passos, R. G., Rodrigues, V. A. J., de Matos, M. P., Santos, C. R. S. & von Sperling, M. 2017 [Performance evaluation of a natural treatment system for small communities, composed of a UASB reactor, maturation ponds \(baffled and unbaffled\) and a granular rock filter in series](#). *Environmental Technology* **39** (4), 490–502.
- Frassinetti, P., Catunda, C. & van Haandel, A. C. 1996 [Improved performance and increased applicability of waste](#)

- stabilisation ponds by pretreatment in a UASB reactor. *Water Science and Technology* **33** (7), 147–156.
- Hernandez-Paniagua, I. Y., Ramirez-Vargas, R., Ramos-Gomez, M. S., Dendooven, L., Avelar-Gonzalez, F. J. & Thalasso, F. 2014 [Greenhouse gas emissions from stabilization ponds in subtropical climate](#). *Environmental Technology* **35** (5–8), 727–734.
- Hey, T., Zarebska, A., Bajraktari, N., Vogel, J., Helix-Nielsen, C., la Cour Jansen, J. & Jonsson, K. 2016 [Influences of mechanical pretreatment on the non-biological treatment of municipal wastewater by forward osmosis](#). *Environmental Technology* **38** (18), 2295–2304.
- Jahn, L., Haslinger, J., Krampe, J., Walder, C., Prösl, A. & Lahnsteiner, J. 2017 [Microsieving as an innovative technology for the energetic use of sewage](#). *Österreichische Wasser- und Abfallwirtschaft* **69** (9–10), 369–377.
- Khan, A. A., Gaur, R. Z., Tyagi, V. K., Khursheed, A., Lew, B., Mehrotra, I. & Kazmi, A. A. 2011 [Sustainable options of post treatment of UASB effluent treating sewage: a review](#). *Resources, Conservation and Recycling* **55** (12), 1232–1251.
- Lazarova, V. & Bahri, A. 2005 *Water Reuse for Irrigation – Agriculture, Landscapes, and Turf Grass*. CRC Press, Florida.
- Mara, D. 2009 [Waste stabilization ponds: past, present and future](#). *Desalination and Water Treatment* **4** (1–3), 85–88.
- Müller, K. 2017 *A Systemic Approach to Implementation of Sanitation and Agricultural Water Reuse*. Verein zur Förderung des Instituts IWAR der TU Darmstadt e.V., Darmstadt, Germany.
- Mwinga, M., Siboleka, M. & Kavezuva, C. 2018 *Economy Profile of Outapi*. First Capital Treasury Solutions (Pty) Limited, Windhoek, Namibia.
- Paulsrud, B., Rusten, B. & Aas, B. 2014 [Increasing the sludge energy potential of wastewater treatment plants by introducing fine mesh sieves for primary treatment](#). *Water Science and Technology* **69** (3), 560–565.
- Prösl, A., Dammert, R., Klegraf, F., Menge, J., Esterhuizen, J., Lahnsteiner, J., Leopold, P. & du Pisani, P. 2013 [Reclamation of blended industrial effluents – pilot tests at Ujams, Windhoek](#). In *9th IWA International Conference on Water Reclamation & Reuse*, Windhoek, Namibia.
- Rusten, B. & Ødegaard, H. 2006 [Evaluation and testing of fine mesh sieve technologies for primary treatment of municipal wastewater](#). *Water Science and Technology* **54** (10), 31–38.
- Shelef, G. & Azov, Y. 2000 [Meeting stringent environmental and reuse requirements with an integrated pond system for the twenty-first century](#). *Water Science and Technology* **42** (10–11), 299–305.
- Shilton, A. 2005 *Pond Treatment Technology*. IWA Publishing, London.
- Sperling, M. 2007 *Waste Stabilisation Ponds*. IWA Publishing, London.
- Tchobanoglous, G. & Abu-Orf, M. 2014 *Wastewater Engineering: Treatment and Resource Recovery*. Metcalf & Eddy, Inc., New York.
- Vassalle, L., Diez-Montero, R., Machado, A. T. R., Moreira, C., Ferrer, I., Mota, C. R. & Passos, F. 2020 [Upflow anaerobic sludge blanket in microalgae-based sewage treatment: co-digestion for improving biogas production](#). *Bioresource Technology* **300**, Article 122677.
- Walder, C., Prösl, A., Klegraf, F., Soerensen, K. & Lahnsteiner, J. 2015 [Enhanced primary treatment using microsieving for increased removal rates and energy recovery on WWTPs](#). In *12th IWA Specialised Conference on Design, Operation and Economics of Large Wastewater Treatment Plants*, Prague.

First received 27 March 2020; accepted in revised form 22 May 2020. Available online 6 July 2020