

Three-Dimensional Printing of Hydrogel Filters Containing Algae Cells for Copper Removal From Contaminated Water

Ketan Thakare¹

Department of Industrial and Systems Engineering, Texas A&M University, College Station, TX 77843
e-mail: ketan.thakare@tamu.edu

Laura Jerpseth

Department of Biology, Texas A&M University, College Station, TX 77843
e-mail: lrj555@tamu.edu

Zhijian Pei

Department of Industrial and Systems Engineering, Texas A&M University, College Station, TX 77843
e-mail: zjpei@tamu.edu

Bryan Tomlin

Department of Chemistry, Texas A&M University, College Station, TX 77843
e-mails: bryan.tomlin@tamu.edu; bryan.tomlin@chem.tamu.edu

Hongmin Qin

Department of Biology, Texas A&M University, College Station, TX 77843
e-mails: hqin@tamu.edu; hqin@bio.tamu.edu

Copper contamination of drinking water and marine areas is detrimental to human health and the environment. Physical and chemical approaches currently used for copper removal from water tend to be expensive and may introduce chemicals to the water. Using suspended algae to remove copper is a biological approach. Its cost is relatively low, and algae can be used for other purposes after being used for copper removal. However, this approach using algae is currently limited in its usefulness due to technological barriers. For example, chemical agents used to remove suspended algae from water after copper is absorbed can cause secondary contamination. Using immobilized algae instead of suspended algae can overcome these problems. In this preliminary study, hydrogel filters containing algae cells and those containing no algae cells are printed on an extrusion-based 3D printer. They were used in a custom-build filtration setup for copper removal. Experimental results show that hydrogel filters containing algae cells reduced copper concentration in the test solution by about 83% (from 3 to 0.5 ppm) after 1 h of filtration, while hydrogel

filters containing no algae cells reduced copper concentration in the test solution by about 50% (from 3 to 1.5 ppm) after 1 h of filtration. [DOI: 10.1115/1.4050761]

Keywords: additive manufacturing, 3D printing

1 Introduction

Copper in contaminated water can have detrimental impacts to human health. Copper toxicity caused by contaminated water cannot be processed by the liver and accumulates in the blood [1]. Copper toxicity is correlated with cognitive decline [2], lysis of blood cells, and liver scarring [3]. Chronic copper toxicity can cause coma, blood vessel collapse, and death [4]. It is estimated that the tap water in about 30% of American households is contaminated with copper, putting millions of Americans at risk of copper poisoning [1]. In the year 2006, Cech et al. tested the water of 45 drinking fountains in five public buildings in Houston, Texas [5]. They found that the copper concentration was up to 5 ppm [5], exceeding the maximum allowable level of 1.3 ppm set by the Environmental Protection Agency (EPA) [6].

In addition, copper contamination can also be harmful to the environment. It was reported that copper concentration in 86% of San Diego's marine areas exceeded EPA's allowable level [7]. Copper contamination can cause abnormal embryo development in marine animals [7] and negatively affect gills, liver, and intestines of fish [8].

Reported approaches to removing heavy metals (including copper) from contaminated water include chemical approaches (such as chemical precipitation [9–11] and carbon adsorption [12–14]) and physical approaches (such as reverse osmosis [15–17]). These approaches can be expensive, because removal of metal ions from aqueous solution is not thermodynamically efficient with current approaches [18]. Additionally, the use of chemicals may lead to secondary contamination, i.e., the chemicals used in water treatment may themselves contaminate the water [19,20].

Besides, there are biological approaches. One of them is to use algae suspended in water. This approach is more accessible in places without complex infrastructure [19]. After water treatment, the algae can be used as feedstock materials for production of biofuel and fertilizer [21].

Currently, however, suspended algae are not used to treat contaminated water at an industrial scale due to a number of technical barriers. It is difficult and expensive to collect algae after treatment [19,21]. Chemical agents are often used to harvest suspended algae from water, creating chemical waste [22]. Furthermore, suspended algae that are not removed from natural bodies of water might lead to algae blooms, i.e., excessive growth of algae [19,23]. Algae blooms can have several detrimental impacts, for example, depleting oxygen in marine bodies as algae decompose [24]. The depletion of oxygen can kill marine life and decrease biodiversity [25].

Printed hydrogel filters containing algae cells can potentially overcome these technical barriers. After treatment of contaminated water, these hydrogel filters containing algae cells can be easily removed from water without using chemical agents. Furthermore, because algae cells are immobilized in the hydrogels of printed filters, there is very limited chance for the algae to leak out, contaminate treated water, or cause algae blooms in natural bodies of water.

The literature contains only limited publications on bioprinting with algae cells. Lode et al. used hydrogel containing *Chlamydomonas reinhardtii* algae cells and human bone cells to print scaffolds [26]. The algae cells provided oxygen required for the survival of the human bone cells in the printed hydrogel scaffolds. Kruczak et al. [27] compared algae cell growth in alginate:methylcellulose scaffolds (printed by an extrusion-based bioprinter) with algae cell growth in liquid suspension. Their results showed that algae embedded in printed scaffolds had a higher growth rate. Their intended applications were production of biofuel and

¹Corresponding author.

Manuscript received December 23, 2020; final manuscript received March 28, 2021; published online April 30, 2021. Assoc. Editor: Robert Chang.

synthesis of additives useful in the pharmaceutical and food industries [27].

The literature has reported studies on using hydrogel beads to remove copper from test solutions, although no reported studies on using printed hydrogel filters containing algae to remove copper from test solutions. For example, hydrogel beads made of alginate were used to remove copper from water in several studies. Tam et al. [28] used alginate beads with a total volume of 600 ml to treat 1.8 l of water solution with copper concentration of 30 ppm. Copper concentration of the solution was reduced to 3 ppm after 5 h of treatment and did not decrease further with additional treatment time. Singh et al. [29] varied multiple factors when testing copper removal by alginate beads, including quantity of alginate, initial copper concentration, pH of water solution, and filtration time. In the least effective set of conditions, alginate beads reduced copper concentration by 3.1%. In the most effective set of conditions, alginate beads reduced copper concentration by 85.3%. The most and least effective sets of conditions had identical alginate quantity and initial copper concentration. However, the most effective set of conditions had longer filtration time and lower pH than the least effective set of conditions. Papageorgiou et al. [30] reported that 1 g of alginate beads reduced copper concentration of 1 l of water from 100 ppm to 5 ppm, after 5 h of treatment. Copper concentration did not significantly decrease with more than 5 h of treatment.

It has also been reported that adding algae cells in alginate beads could accelerate the removal of copper from the solution. Aksu et al. [31] reported that alginate beads alone removed a maximum of approximately 80 ppm of copper from 1 l of water, while alginate beads containing algae *Chlorella vulgaris* removed a maximum of 92 ppm of copper from 1 l of water. For both conditions, beads were in contact with water for 6 h. Mata et al. [32] reported that alginate beads reduced the concentration of copper by 38 ppm from 1 l of water after 24 h, while alginate beads containing algae *F. vesiculosus* removed the same amount of copper after 4 h. The beads containing algae removed a maximum of 57 ppm of copper from 1 l of water after 24 h.

There are potential benefits of using 3D-printed filters over alginate beads. Alginate beads usually have a diameter as small as 0.4 mm [30]. The larger size of 3D-printed filters makes it easier to remove them from bodies of water after copper removal. Additionally, alginate beads are susceptible to dissolve in water [33]. The hydrogel used to print filters contains methylcellulose, which should be able to prevent the filters from dissolving, and the shape of printed filters can be controlled to better fit their applications.

Currently, the literature has no reported study on 3D printing of hydrogel filters containing algae cells for copper removal from contaminated water. This paper reports the first study in the literature on 3D printing of hydrogel filters containing algae cells for copper removal from contaminated water. In this study, hydrogel filters containing algae cells and those containing no algae cells were printed on an extrusion-based 3D printer. They were then used in a custom-build filtration setup for copper removal. Test solution with copper concentration of 3 ppm was prepared and circulated through the filtration system for 4 h. Samples of the test solution were taken every 1 h. Copper concentration data of these samples were analyzed.

2 Materials and Methods

2.1 Preparation of Algae Cells. The majority of the algae preparation procedure is described in a paper previously published [34]. *Chlamydomonas reinhardtii* algae strain cc125 (Chlamydomonas Resource Center, University of Minnesota, Minneapolis, MN) was used for algae cell preparation. In addition to the steps of the previous procedure [34], 10 ml of the tris acetate phosphate (TAP)-algae solution was added to a new flask (VWR, Radnor, PA) that contained 100 ml of liquid TAP medium, producing a 110 ml of TAP-algae solution. The new flask of the TAP-algae

solution was then placed under lightbulbs for 24 h to allow algae cells to grow. These additional steps were added to ensure that the algae cells had access to fresh liquid TAP medium. The fresh medium was ideal for cell growth [35], because it contained fresh nutrients and not accumulated cellular waste products, such as free radicals and methane.

2.2 Preparation of Hydrogel Bioink. The bioink preparation procedure is described in a previously published paper [33]. The cell concentration of the hydrogel bioink (used to print hydrogel filters containing algae) was 150,000 cells/ml. The cell concentration was chosen based on a study previously published by the authors [34]. In that study, the effects of extrusion pressure and needle diameter on cell quantity in 3D-printed samples were investigated.

2.3 Design and Printing of Hydrogel Filters. The filter was designed using Fusion 360 (Autodesk, San Rafael, CA), shown in Fig. 1. The filters had a shape of a square disk. Its length was 25 mm and thickness was 1.5 mm. It also had eight through holes with a diameter of 2 mm. The STL (standard tessellation language) file generated by FUSION 360 software was converted into a G-code file using SLICER software (SLICER.org, USA). This G-code file was then imported into ALLEVI BIOPRINTER software (Allevi Inc., Philadelphia, PA).

Allevi 1 bioprinter, shown in Fig. 2, was used to print the filters. Five milliliters of bioink were loaded into the extrusion syringe (Allevi Inc.) equipped with a 30-gauge needle (Allevi). Each of

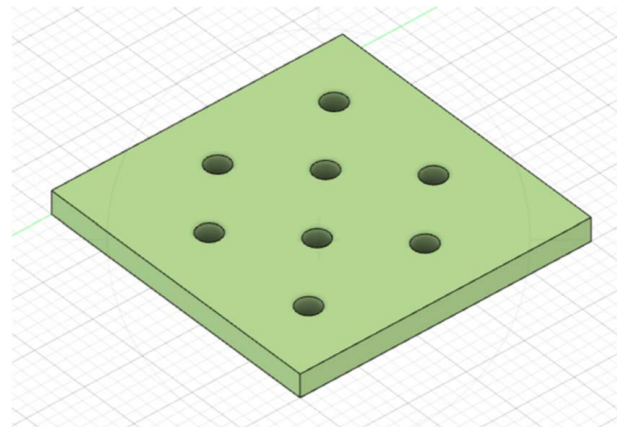

Fig. 1 Filter design

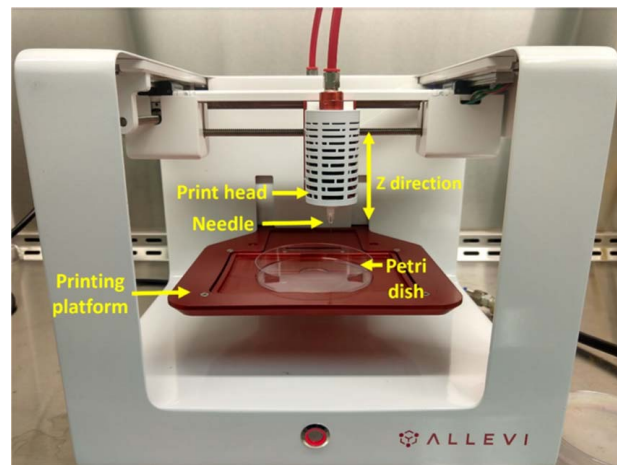

Fig. 2 Allevi 1 bioprinter

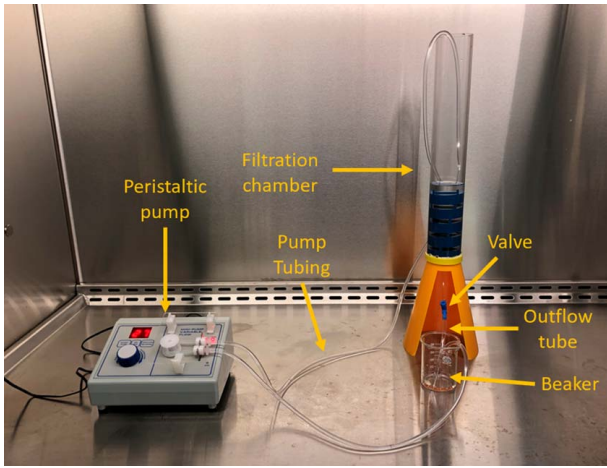

Fig. 3 Custom-made filtration setup

the filters was printed on a 10-cm petri dish (VWR, Radnor, PA). Printing speed was 6 mm/s and extrusion pressure was 95 psi. The layer height was 0.1 mm.

Immediately after printing, 5 mm of 4%, w/v, CaCl_2 solution was added to the petri dish containing the printed filter for 2 min to allow for crosslinking of alginate [36]. The crosslinking creates chemical bonds between polymer chains of the printed filters, in order for the filters to maintain their printed shape. After crosslinking was completed, liquid TAP media was then poured over the filters to allow the algae cells to grow. The filters were then kept at room temperature, under lightbulbs for four days to give the algae cells sufficient time to grow.

Hydrogel filters containing algae cells and those containing no algae cells were printed using the same printing conditions and on the same day. A previously published study [34] has demonstrated that algae cells can successfully grow in 3D-printed hydrogel samples.

2.4 Custom-Made Filtration Setup. The custom-made filtration setup is shown in Fig. 3. It mainly consisted of a peristaltic pump, pump tubing, a filtration chamber, an outflow tube, a valve, and a beaker. The filtration chamber, as shown in Fig. 4, consisted of a segment of acrylic cylinder, and four platforms printed using Stratasys PolyJet 750. The computer-aided design (CAD) model of the platforms is shown in Fig. 5. The circular platforms had a diameter of 46 mm, and a total height of 22 mm. The platforms were vertically stackable, allowing them to be placed on top of each other. Each platform had a recess with a sieve-like bottom (for placing a printed filter). The sieve-like bottom had 13 holes with a diameter of 2 mm. The bottom end of the filtration chamber was connected to a valve to control the flowrate of test solution going out of the chamber. An outflow tube was connected to the valve at one end (with the other end inside a beaker) to direct the flow of test solution out from the filtration chamber.

A 100-ml beaker (VWR, Radnor, PA) was used to collect the test solution from the outflow tube. The peristaltic pump (model no. 3386, Control Company, TX), together with pump tubing, was used to circulate the test solution from the beaker through the filtration chamber. One end of the pump tubing was placed inside the beaker and the other end was placed inside the filtration chamber.

2.5 Test Solution Preparation. The following steps describe the test solution preparation and are shown in Fig. 6.

Step 1: A 500-ml beaker (VWR) was filled with 200 ml of ultrapure 18.2 megohm water. The ultrapure water was obtained from an ultrapure water filtration system (Barnstead,

Waltham, MA) and contains less than 0.00001 ppm of trace metals.

Step 2: Using a pipette (Rainin, Oakland, CA), 0.6 ml of ultrapure water was removed from the beaker, leaving 199.4 ml of water inside the beaker.

Step 3: Using a pipette, 0.6 ml of 1000 ppm copper stock solution (Sigma-Aldrich, St. Louis, MO) was added to the beaker of ultrapure water. The copper concentration of the 200 ml of test solution in the beaker became 3 ppm.

Step 4: The test solution was evenly divided, with the help of a pipette, into two separate 250-ml beakers, each containing 100 ml of test solution.



Fig. 4 Filtration chamber

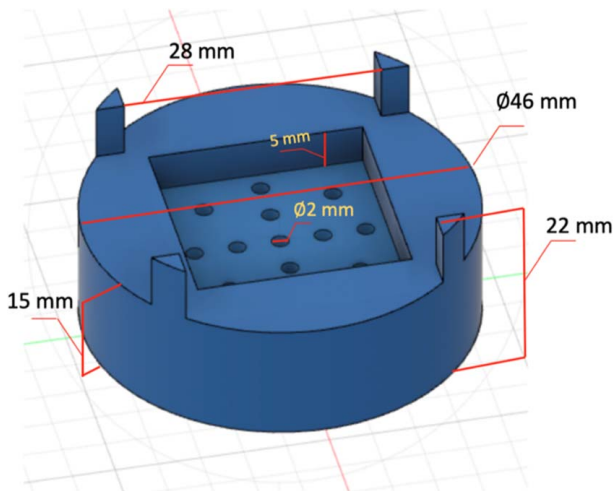

Fig. 5 CAD design of the platform

The test solution in one beaker was for the filtration experiment using hydrogel filters containing algae cells, and the test solution in the other beaker was for the filtration experiment using hydrogel filters containing no algae cells. The test solution was prepared on the same day the filtration experiments were performed. Copper concentration of 3 ppm was chosen to compare with a previously published study. In the previous study, suspended algae were used to remove copper from test solutions that had copper concentration of 3 ppm [37].

2.6 Filtration Experiment Procedure. The filtration experiment setup was put together and the filtration experiments were performed in the biosafety cabinet to prevent contamination. The filtration experiment procedure had the following steps.

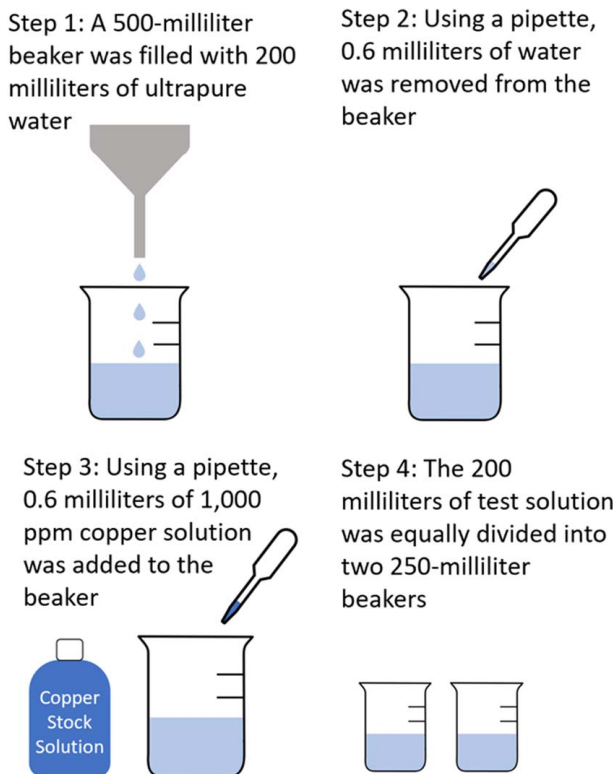

Fig. 6 Test solution preparation

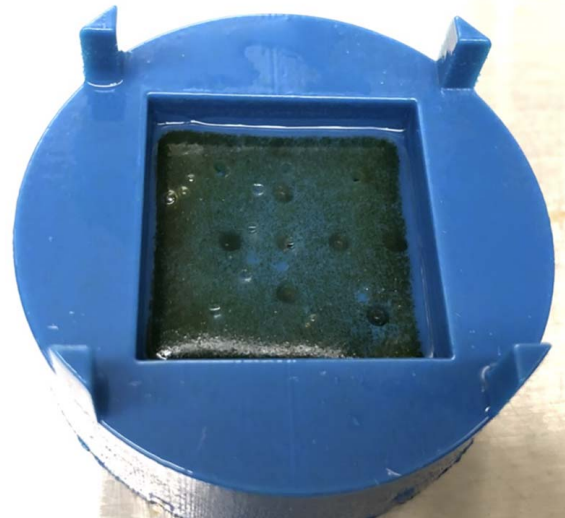

Fig. 7 3D-printed hydrogel filter inside the recess of a platform

- Step 1:* The components of the filtration setup were placed inside the biosafety cabinet.
- Step 2:* A hydrogel filter was placed on one of the 3D-printed platforms, as shown in Fig. 7.
- Step 3:* The platform, together with the filter, was placed inside the filtration chamber.
- Step 4:* Steps 2 and 3 were repeated until all four platforms (and hydrogel filters) were vertically stacked inside the filtration chamber.
- Step 5:* The valve at the bottom of the filtration chamber was closed, and 100 ml of test solution was pumped into the chamber from the 250-ml beaker. This amount of test solution in the filtration chamber was enough to completely submerge the platforms and filters.
- Step 6:* The valve was opened to allow the test solution to flow out of the filtration chamber through the outflow tube and into the beaker. The valve was set to allow a flowrate of 15 ml/min.
- Step 7:* After the valve was opened, the peristaltic pump was set to continuously pump the test solution from the beaker into the filtration chamber. The flowrate of the pump was also set at 15 ml/min. This was done to maintain constant volume of test solution in the chamber. Approximately 5 ml of test solution were in the beaker at any time, and 95 ml of test solution were in the filtration chamber.

The same filtration procedure was followed for the experiment using hydrogel filters containing algae and those without algae. Both experiments were conducted on the same day.

2.7 Sample Collection and Measurement of Copper Concentration of the Samples Using Inductively Coupled Plasma-Mass Spectrometry. The filtration experiment started when the valve was opened, and ended after 4 h. Three samples of test solution were taken from the beaker at the start of the experiment and at intervals of 1 h, until 4 h had passed.

The following steps are for collecting samples, preparation of the samples for copper concentration measurement, and copper concentration measurement on the inductively coupled plasma-mass spectrometry (ICP-MS).

- Step 1:* For each sample, approximately 0.2 ml of test solution was collected and put in a 1.5-ml Eppendorf tube (Eppendorf, Framingham, MA).
- Step 2:* For each sample, there was a 50-ml BD tube (Becton Dickinson, Franklin Lakes, NJ) filled with 10 ml of 2%

nitric acid. The 2% nitric acid was prepared by diluting 70% TraceMetal Grade nitric acid (Fisher Scientific, Waltham, MA) with ultrapure 18.2 megohm water.

Step 3: The test solution samples were diluted. To perform the dilution, a pipette was used to transfer 0.01 ml of test solution from the Eppendorf tube to a BD tube containing 10 ml of 2% nitric acid. It was necessary to dilute the samples by a factor of 1000, because the ICP-MS instrument cannot measure copper concentration above 0.2 ppm.

Step 4: ICP-MS was used to measure the copper concentrations of the diluted samples in the BD tubes. Prior to every measurement, a solution of 2% nitric acid was used to wash off residual copper left on the instrument from the previous measurement.

3 Results and Discussion

Copper concentration measurement data of all samples are in Tables 1 and 2. Figure 8 shows the relationship between copper concentration in the test solution and filtration time the test solution had been in the filtration chamber. The error bars represent one standard deviation of measured data for the three samples at each data point. The green horizontal line represents the detection limit of the ICP-MS instrument. For the hydrogel filters containing algae cells, between the start of the filtration experiment and 1 h filtration time, copper concentration decreases by 82.3%. After 2 h of filtration, copper concentration decreases to below the detection limit of the ICP-MS instrument. Conservatively, this detection limit is 0.001 ppm [38]. Copper concentration remains below the detection limit of the ICP-MS instrument for filtration time of 3 h and 4 h.

Observing the relationship curve for the hydrogel filters containing no algae cells, between the start of the filtration and 1 h filtration time, copper concentration decreases by 47.8%. By 2 h of filtration time, copper concentration decreases by 82.5% from the initial copper concentration. This decrease in copper concentration is relatively smaller in comparison to hydrogel filters containing algae cells. Copper concentration of test solution filtered by hydrogel filters containing no algae cells decreases below the ICP-MS detection limit at 3 h of filtration time and remains below the detection limit at 4 h filtration time. The hydrogel filters containing algae cells can remove copper almost twice as fast as hydrogel filters containing no algae cells.

Non-parametric Kruskal–Wallis tests were conducted to evaluate whether there is a statistically significant relationship between copper concentration of test solution and filtration time (analysis of variance (ANOVA) analysis could not be used for this purpose because the two basic assumptions were not met). A *p*-value of

Table 1 Measurement data of copper concentration (ppm) for hydrogel filters containing algae cells

Time (h)	Sample 1	Sample 2	Sample 3	Mean	Standard deviation
0	3.088	2.913	2.911	0.083	0.083
1	0.458	0.715	0.525	0.136	0.136
2	0.001	0.001	0.001	0.001	0
3	0.001	0.001	0.001	0.001	0
4	0.001	0.001	0.001	0.001	0

Table 2 Measurement data of copper concentration (ppm) for hydrogel filters containing no algae cells

Time (h)	Sample 1	Sample 2	Sample 3	Mean	Standard deviation
0	3.088	2.913	2.911	2.971	0.083
1	1.876	1.009	1.76	1.548	0.384
2	0.678	0.513	0.358	0.519	0.134
3	0.001	0.001	0.001	0.001	0
4	0.001	0.001	0.001	0.001	0

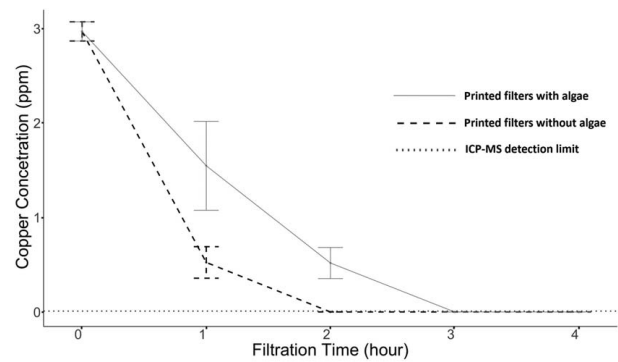

Fig. 8 Relationship between copper concentration and filtration time

0.0082 was obtained on performing the Kruskal–Wallis tests. This indicates that, at the significance level of 0.01, there is a statistically significant relationship between copper concentration and filtration time. Information about the Kruskal–Wallis test, ANOVA, and *p*-value can be found in textbooks such as the one by Ott and Longnecker [39].

In a study conducted by the authors, suspended algae cells were used to remove copper from test solutions [37]. Two levels of initial copper concentration of the test solutions were 1.5 and 3 ppm, respectively. Two levels of contact time (of algae with test solutions) were 2.5 and 5 h, respectively. Four possible combinations of initial copper concentration and contact time were tested. The suspended algae were able to decrease copper concentration from 1.5 ppm to 0.038 ppm after 2.5 h. For comparison, printed algae filters were able to decrease copper concentration from 3 ppm to less than 0.001 ppm after 2 h.

4 Concluding Remarks

Extrusion-based 3D bioprinting was used to print hydrogel filters with and without algae cells. These filters were used to remove copper in test solution. It was concluded that hydrogel filters with and without algae cells can reduce copper concentration in test solution, and hydrogel filters containing algae cells remove copper twice as fast as hydrogel filters containing no algae cells.

Further studies are needed to investigate the amount of copper that can be removed from solution by a hydrogel filter containing algae cells and the time required to remove the copper. Further investigations are also planned to determine whether any potential metabolic wastes are produced by algae during the filtration process, to evaluate the potential risk of contaminants by algae filters. In addition, studies are needed to investigate whether hydrogel filters containing algae cells can be used to remove other heavy metals, such as arsenic, cadmium, and lead from contaminated water, since these heavy metals are responsible for numerous ill effects on human health and the environment. Other future studies can include investigations on the differences in metal removal between various species of algae contained in the hydrogel filters, the lifespan of printed hydrogel filters containing algae, and 3D printing methods to print more dimensionally accurate hydrogel filters.

Funding Data

The authors acknowledge funding from the Air Force Office of Scientific Research (AFOSR; Grant No. FA9550-18-1-0233).

Conflict of Interest

There are no conflicts of interest.

Data Availability Statement

The datasets generated and supporting the findings of this article are obtained from the corresponding author upon reasonable request. The authors attest that all data for this study are included in the paper.

References

- [1] Brewer, G. J., 2010, "Risks of Copper and Iron Toxicity During Aging in Humans," *Chem. Res. Toxicol.*, **23**(2), pp. 319–326.
- [2] Squitti, R., Barbati, G., Rossi, L., Ventriglia, M., Dal Forno, G., Cesaretti, S., Moffa, F., Caridi, I., Cassetta, E., and Pasqualetti, P., 2006, "Excess of Nonceruloplasmin Serum Copper in AD Correlates With MMSE, CSF β -Amyloid, and h-tau," *Neurology*, **67**(1), pp. 76–82.
- [3] Gaetke, L. M., and Chow, C. K., 2003, "Copper Toxicity, Oxidative Stress, and Antioxidant Nutrients," *Toxicology*, **189**(1–2), pp. 147–163.
- [4] Winge, D. R., and Mehra, R. K., 1990, "Host Defenses Against Copper Toxicity," *Int. Rev. Exp. Pathol.*, **31**, pp. 47–83.
- [5] Cech, I., Smolensky, M. H., Afshar, M., Broyles, G., Barczyk, M., Burau, K., and Emery, R., 2006, "Lead and Copper in Drinking Water Fountains—Information for Physicians," *South. Med. J.*, **99**(2), pp. 137–142.
- [6] Long, S., and Martin, T., 1990, *Method 200. 8 Determination of Trace Elements in Waters and Wastes by Inductively Coupled Plasma: Mass Spectrometry. Revision 4. 3*, Environmental Protection Agency, Cincinnati, OH.
- [7] Schiff, K., Brown, J., Diehl, D., and Greenstein, D., 2007, "Extent and Magnitude of Copper Contamination in Marinas of the San Diego Region, California, USA," *Mar. Pollut. Bull.*, **54**(3), pp. 322–328.
- [8] Blanchard, J., and Grosell, M., 2006, "Copper Toxicity Across Salinities From Freshwater to Seawater in the Euryhaline Fish *Fundulus heteroclitus*: Is Copper an Ionoregulatory Toxicant in High Salinities?," *Aquat. Toxicol.*, **80**(2), pp. 131–139.
- [9] Baltupurins, K., Burns, R., and Lawrance, G., 1996, "Heavy Metals in Wastewater: Modelling the Hydroxide Precipitation of Copper (II) From Wastewater Using Lime as the Precipitant," *Waste Manage.*, **16**(8), pp. 717–725.
- [10] Fu, F., Xie, L., Tang, B., Wang, Q., and Jiang, S., 2012, "Application of a Novel Strategy—Advanced Fenton-Chemical Precipitation to the Treatment of Strong Stability Chelated Heavy Metal Containing Wastewater," *Chem. Eng. J.*, **189**, pp. 283–287.
- [11] Mirbagheri, S. A., and Hosseini, S. N., 2005, "Pilot Plant Investigation on Petrochemical Wastewater Treatment for the Removal of Copper and Chromium With the Objective of Reuse," *Desalination*, **171**(1), pp. 85–93.
- [12] Demiral, H., and Güngör, C., 2016, "Adsorption of Copper (II) From Aqueous Solutions on Activated Carbon Prepared From Grape Bagasse," *J. Cleaner Prod.*, **124**, pp. 103–113.
- [13] Monser, L., and Adhoum, N., 2002, "Modified Activated Carbon for the Removal of Copper, Zinc, Chromium and Cyanide From Wastewater," *Sep. Purif. Technol.*, **26**(2–3), pp. 137–146.
- [14] Mubarak, N., Sahu, J., Abdullah, E., and Jayakumar, N., 2014, "Removal of Heavy Metals From Wastewater Using Carbon Nanotubes," *Sep. Purif. Rev.*, **43**(4), pp. 311–338.
- [15] Cséfalvay, E., Pauer, V., and Mizsey, P., 2009, "Recovery of Copper From Process Waters by Nanofiltration and Reverse Osmosis," *Desalination*, **240**(1–3), pp. 132–142.
- [16] da Silva, J. R. P., Merçon, F., da Silva, L. F., Cerqueira, A. A., Ximango, P. B., and da Costa Marques, M. R., 2015, "Evaluation of Electrocoagulation as Pre-Treatment of Oil Emulsions, Followed by Reverse Osmosis," *J. Water Process Eng.*, **8**, pp. 126–135.
- [17] Li, Y., Xu, Z., Liu, S., Zhang, J., and Yang, X., 2017, "Molecular Simulation of Reverse Osmosis for Heavy Metal Ions Using Functionalized Nanoporous Graphenes," *Comput. Mater. Sci.*, **139**, pp. 65–74.
- [18] Martínez, A., Uche, J., Rubio, C., and Carrasquer, B., 2010, "Exergy Cost of Water Supply and Water Treatment Technologies," *Desalin. Water Treat.*, **24**(1–3), pp. 123–131.
- [19] Abdel-Raouf, N., Al-Homaidan, A., and Ibraheem, I., 2012, "Microalgae and Wastewater Treatment," *Saudi J. Biol. Sci.*, **19**(3), pp. 257–275.
- [20] Jarvis, A., Gandy, C., Bailey, M., Davis, J., Orme, P., Malley, J., Potter, H., and Moorhouse, A., 2015, "Metal Removal and Secondary Contamination in a Passive Metal Mine Drainage Treatment System," Proceedings of the 10th International Conference on Acid Rock Drainage, Santiago, Chile, Apr. 21–24.
- [21] Christenson, L., and Sims, R., 2011, "Production and Harvesting of Microalgae for Wastewater Treatment, Biofuels, and Bioproducts," *Biotechnol. Adv.*, **29**(6), pp. 686–702.
- [22] Hoffmann, J. P., 1998, "Wastewater Treatment With Suspended and Nonsuspended Algae," *J. Phycol.*, **34**(5), pp. 757–763.
- [23] Zeraatkar, A. K., Ahmadzadeh, H., Talebi, A. F., Moheimani, N. R., and McHenry, M. P., 2016, "Potential Use of Algae for Heavy Metal Bioremediation, a Critical Review," *J. Environ. Manage.*, **181**, pp. 817–831.
- [24] Hallegraef, G., 2003, "Harmful Algal Blooms: A Global Overview," *Man. Harmful Mar. Microalgae*, **33**, pp. 1–22.
- [25] Carmichael, W. W., and Boyer, G. L., 2016, "Health Impacts From Cyanobacteria Harmful Algal Blooms: Implications for the North American Great Lakes," *Harmful Algae*, **54**, pp. 194–212.
- [26] Lode, A., Kruijtz, F., Brüggemeier, S., Quade, M., Schütz, K., Knaack, S., Weber, J., Bley, T., and Gelinsky, M., 2015, "Green Bioprinting: Fabrication of Photosynthetic Algae Laden Hydrogel Scaffolds for Biotechnological and Medical Applications," *Eng. Life Sci.*, **15**(2), pp. 177–183.
- [27] Kruijtz, F., Lode, A., Brüggemeier, S., Schütz, K., Kramer, J., Bley, T., Gelinsky, M., and Weber, J., 2015, "Green Bioprinting: Viability and Growth Analysis of Microalgae Immobilized in 3D Plotted Hydrogels Versus Suspension Cultures," *Eng. Life Sci.*, **15**(7), pp. 678–688.
- [28] Tam, N. F., Wong, Y.-S., and Simpson, C. G., 1998, "Removal of Copper by Free and Immobilized Microalga, *Chlorella vulgaris*," *Wastewater Treatment With Algae*, Y. Wong, and N. F. Y. Tam, ed., Springer, New York, pp. 17–36.
- [29] Singh, L., Pavankumar, A. R., Lakshmanan, R., and Rajarao, G. K., 2012, "Effective Removal of Cu²⁺ Ions From Aqueous Medium Using Alginate as Biosorbent," *Ecol. Eng.*, **38**(1), pp. 119–124.
- [30] Papageorgiou, S., Kouvelos, E., and Katsaros, F., 2008, "Calcium Alginate Beads From *Laminaria digitata* for the Removal of Cu²⁺ and Cd²⁺ From Dilute Aqueous Metal Solutions," *Desalination*, **224**(1–3), pp. 293–306.
- [31] Aksu, Z., Eğretli, G., and Kutsal, T., 1998, "A Comparative Study of Copper (II) Biosorption on Ca-Alginate, Agarose and Immobilized *C. vulgaris* in a Packed-Bed Column," *Process Biochem.*, **33**(4), pp. 393–400.
- [32] Mata, Y., Blázquez, M., Ballester, A., González, F., and Munoz, J., 2009, "Biosorption of Cadmium, Lead and Copper With Calcium Alginate Xerogels and Immobilized *Fucus vesiculosus*," *J. Hazard. Mater.*, **163**(2–3), pp. 555–562.
- [33] Bajpai, S. K., and Sharma, S., 2004, "Investigation of Swelling/Degradation Behaviour of Alginate Beads Crosslinked With Ca²⁺ and Ba²⁺ Ions," *React. Funct. Polym.*, **59**(2), pp. 129–140.
- [34] Thakare, K., Jerpseth, L., Qin, H., and Pei, Z., 2020, "Bioprinting Using Algae: Effects of Extrusion Pressure and Needle Diameter on Cell Quantity in Printed Samples," *ASME J. Manuf. Sci. Eng.*, **143**(1), p. 014501.
- [35] Malik, K. A., 1995, "A Convenient Method to Maintain Unicellular Green Algae for Long Times as Standing Liquid Cultures," *J. Microbiol. Methods*, **22**(3), pp. 221–227.
- [36] Russo, R., Abbate, M., Malinconico, M., and Santagata, G., 2010, "Effect of Polyglycerol and the Crosslinking on the Physical Properties of a Blend Alginate-Hydroxyethylcellulose," *Carbohydr. Polym.*, **82**(4), pp. 1061–1067.
- [37] Thakare, K., Jerpseth, L., Qin, H., and Pei, Z., 2020, "Preliminary Investigation of Removing Copper Contamination From Water Using Algae," Proceedings of ASME 2020 International Manufacturing Science and Engineering Conference (MSEC), MSEC2020-8521.
- [38] Lee, S., Bi, X., Reed, R. B., Ranville, J. F., Herckes, P., and Westerhoff, P., 2014, "Nanoparticle Size Detection Limits by Single Particle ICP-MS for 40 Elements," *Environ. Sci. Technol.*, **48**(17), pp. 10291–10300.
- [39] Ott, R. L., and Longnecker, M. T., 2015, *An Introduction to Statistical Methods and Data Analysis*, Nelson Education, Toronto, Canada.