

# A Machine Learning Enabled Multi-Fidelity Platform for the Integrated Design of Aircraft Systems

**Ana Garcia Garriga**

Autonomous and Intelligent Systems Department  
at United Technologies Research Center,  
Cork T23 XN53, Ireland  
e-mail: garciaga@utrc.utc.com

**Laura Mainini<sup>1</sup>**

Autonomous and Intelligent Systems Department  
at United Technologies Research Center,  
Cork T23 XN53, Ireland  
e-mail: maininL@utrc.utc.com

**Sangeeth Saagar Ponnusamy**

Autonomous and Intelligent Systems Department  
at United Technologies Research Center,  
Cork T23 XN53, Ireland  
e-mail: ponuss@utrc.utc.com

*The push toward reducing the aircraft development cycle time motivates the development of collaborative frameworks that enable the more integrated design of aircraft and their systems. The Modelling and Simulation tools for Systems IntegratiON on Aircraft (MISSION) project aims to develop an integrated modelling and simulation framework. This paper focuses on some recent advancements in the MISSION project and presents a design framework that combines a filtering process to down-select feasible architectures, a modeling platform that simulates the power system of the aircraft, and a machine learning-based clustering and optimization module. This framework enables the designer to prioritize different designs and offers traceability on the optimal choices. In addition, it enables the integration of models at multiple levels of fidelity depending on the size of the design space and the accuracy required. It is demonstrated for the electrification of the Primary Flight Control System (PFCS) and the landing gear braking system using different electric actuation technologies. The performance of different architectures is analyzed with respect to key performance indicators (fuel burn, weight, power). The optimization process benefits from a data-driven localization step to identify sets of similar architectures. The framework demonstrates the capability of optimizing across multiple, different system architectures in an efficient way that is scalable for larger design spaces and larger dimensionality problems. [DOI: 10.1115/1.4044401]*

*Keywords: conceptual design, design integration, design of multiscale systems, multidisciplinary design and optimization, simulation-based design, systems design, systems engineering*

## 1 Introduction

The popularization of air travel and the increased number of flights have caused the environmental impact of aviation to rise to worrying levels. According to a European Commission report on the impacts of aviation, the CO<sub>2</sub> released by the global air transportation system grew 80% between 1945 and 2014; the NO<sub>x</sub> emissions doubled in the same period [1], and they are projected to grow more than 40% up to 2035 if no action is taken. To mitigate these impacts, the Advisory Council for Aeronautics Research in Europe (ACARE) has set goals for the aviation industry to reach by the year 2050 [2]. The ACARE goals include the following: a 50% cut in CO<sub>2</sub> emissions per passenger kilometer and an 80% cut in NO<sub>x</sub> emissions, plus a reduction in perceived noise to one-half of current average levels. In order to achieve these ambitious goals, new technologies need to be introduced, and many of these technologies require higher integration between aircraft systems and an improved collaboration between the different actors in an aircraft manufacturer chain. The European Commission has launched a series of research projects, since the sixth framework program, and up to the current Clean Sky 2 Joint Technology Initiative [3], as the vehicle to achieve the goals set out by ACARE through the research and development of processes, tools, and technologies. These projects aim to develop a more collaborative and integrated design process of different aircraft systems and comprise a variety of approaches and applications, ranging from thermal integration, to electrical architecting, to cockpit design [4–8].

The work presented in this paper is part of the efforts in the Modelling and Simulation tools for Systems IntegratiON on Aircraft (MISSION) project [9], which is part of the Clean Sky 2 initiative. The main objective of the overall project is to develop an integrated modeling and simulation framework capable of supporting the entire aircraft development cycle and enable collaboration between different entities through the use of open standards such as the Functional Mock-up Interface [10,11], a cross-tool standard for co-simulation and model exchange. These design problems are multidomain in nature and require holistic and multidisciplinary approaches to the assessment of the impact of technology changes on aircraft performance.

This paper addresses the problem of integrating multidomain models and handling libraries of systems representations at different levels of fidelity for the efficient exploration, analysis, and optimization of novel aircraft system architectures. Particular attention is dedicated to the design and optimization of the different power flows in the aircraft with the demonstration of the framework for two use cases related to the adoption of new More-Electric technologies in actuation systems. When a new design for an aircraft system is being developed, there are many technologies to consider integrating. These technologies cover both traditional and novel design. The choice between different technologies can cause many changes to the overall system architecture due to a small change in a specific system. The choice among multiple technology options for many aircraft systems coupled with the downstream changes associated with them generates a very large design space. However, many technologies are incompatible and many architecture options do not fulfill requirements, which leads to large pockets of unfeasible architectures that can be discarded outright, and many feasible architectures are suboptimal due to unconstrained redundancies and oversizing. An aircraft system architecture includes many components and analyzing its performance is

<sup>1</sup>Corresponding author.

Contributed by the Design Automation Committee of ASME for publication in the JOURNAL OF MECHANICAL DESIGN. Manuscript received March 5, 2019; final manuscript received July 13, 2019; published online August 1, 2019. Assoc. Editor: Samy Missoum.

a computationally expensive effort due to the multiple components and behaviors that need to be modeled and simulated. This motivates the need to limit the number of architectures to be evaluated as it reduces the computational expense. However, not limiting the designer to well-known designs by over-constraining is also crucial as the intent is to explore the design space opened up by new technologies. This motivates the framework presented in this paper, which is detailed in Sec. 2.

The framework proposed combines a computational module that filters out unfeasible architectures with an evaluation module able to capture the effect of the changes at the system level in the aircraft power architecture. The results from these two modules are then localized to sets of similar architectures. These sets are assessed according to different performance metrics to identify the optimal one. Then, the optimal architecture is computed within the optimal set. This methodology can be used with models of different fidelities at different stages of the design process as the design space is reduced and localized according to the designer's needs.

The evaluation of the aircraft system architecture step requires the analysis of multiple aircraft system models and necessarily involves analysis based on multiple disciplines and the interaction of the disciplines in the design space. The number of architectures being evaluated in this paper requires that the evaluation step maintains a reasonable computational cost per architecture. In order to achieve this, we explored a broad set of multidisciplinary design optimization (MDO) approaches. A seminal survey of different MDO formulations is proposed by Sobieszcanski-Sobieski and Haftka in 1997 [12], and a subsequent review of the state of the art was published by Agte et al. [13] and Martins and Lambe [14]; multiple examples of multidisciplinary design and optimization approaches for aircraft can be found in the literature [15–18]. The problem of addressing the design of onboard aircraft systems within a multidisciplinary framework has been addressed also in the context of the AGILE project [19–21] by Roy et al. [22] and by Tfaily and Kokkolaras [23].

In addition to the multidisciplinary aspect of the multiple aircraft systems, the presence of highly integrated aircraft systems added to the size of the design space could result in a very computationally challenging problem if all systems were evaluated at a high level of fidelity, even if the disciplinary couplings are efficiently managed. For this reason, the fidelity of the models involved has to be carefully managed in order to provide the necessary level of fidelity for the analysis needed in the minimum simulation time. Multiple approaches to multifidelity problems are present in the literature, a set of previous works tackle the problem using surrogate and lower-fidelity models to address the disparity in fidelity [24,25]. Another approach covered in literature focuses in the collaborative and distributed elements of modeling at different levels of fidelity [26–28], as well as more recent advancements focused in aircraft design problems in the SUAVE project [29], Clark et al. [30], Bryson et al. [31], and the AGILE project [21,32]. There are also significant contributions to the recent literature on multi-fidelity approaches under uncertainty [33,34], and more novel approaches to surrogate modelling techniques [35,36].

In this paper, machine learning techniques are applied not only to reduce the models to a manageable level of complexity but also to reduce the number of architectural options after the first evaluation is performed by implementing a classification algorithm. Numerous approaches to leveraging machine learning techniques in complex engineering design problems are present in literature [37–40]. Early applications in the aerospace domain include the use of support vector machines [41] and kriging [42] and co-kriging [43] methods for metamodels as well as the application of Bayesian [44] and neural networks [45] for the classification of architectures and topologies. More recently, the field of aerospace design has been enhanced by a broader use of machine learning applications for a multitude of specific design problems and applications [46–50]. Previous work in the context of the MISSION project focuses on the integration of the system-level dynamics with the

aircraft-level [51] and the design of controls for multiple aircraft systems [52]. This paper leverages the modeling framework proposed in Garcia Garriga et al. [53] to enable trade-off studies among multiple power architectures in the evaluation of aircraft system architectures and proposes a principled approach to reduce the architecture design space and speed up the identification of the optimal architecture.

We demonstrate the framework proposed in this paper for two use cases: the electrification of the primary flight control system (PFCS) and the landing gear (LG) braking system of a short-range aircraft. The use cases are chosen because PFCS and braking system electrification are one of the key enablers of the evolution toward more-electric aircraft [54–56] and, ultimately, fully electric aircraft. The possible technologies considered to replace the traditional servo-hydraulic actuation (SHA) system are electro-mechanical actuation (EMA) and electro-hydrostatic actuation (EHA), in addition to the original hydraulic actuation and EHA as a backup solution (EBHA) for the PFCS as in existing more-electric aircraft such as the A380 and the B787.

In this paper, Sec. 2 explains the methodology applied to the optimization process; Sec. 3 describes the setup of the two use cases ran to demonstrate the methodology. Then, Sec. 4 presents the results of the case studies. Finally, Sec. 5 draws the conclusions and outlines the avenues of future development.

## 2 Methodology

This section presents the methodology developed for the design and optimization of power architectures and offers a more detailed description of its constituent modules. In particular, we propose a three-step procedure that combines three constitutive modules as shown in Fig. 1.

The complete set of possible configurations is processed by the architecture exploration block (I, Sec. 2.1): a computational module that filters out the unfeasible architectures in subsequent filtering steps. Once the architecture space is sufficiently reduced—meaning the modeling framework can evaluate its performance within the time constraints given—the performance of the feasible architectures is analyzed using the architecture evaluation block (II, Sec. 2.2). This block consists of high-level modeling platform for the aircraft's power systems plus higher fidelity system models for the systems studied in order to assess their impact at aircraft level. The results of this evaluation are then processed in the clustering and optimization block [III, Sec. 2.3]. In this step, the results are first reduced to significantly different sets of similar architectures according to given design metrics. Those families of architectures can then be evaluated for multi-objective optimization tasks that can occur at the family of architectures level and within each family. The optimization tasks select the optimal candidate architecture in two steps: first by shortlisting the best set of architectures and then either identifying the best in class within this set or choosing the closest architecture to the representative architecture in the set (centroid). The final outcome is a very reduced number of feasible and non-dominated architectures, giving the designer the option to choose the optimal one based on their prioritization of objectives. Each of these steps is described in greater detail later in this section of the paper.

This method aims to reduce the number of candidate architectures to evaluate through different subsequent screening steps while keeping traceability to higher level requirements. The progressive reduction of the number of architectures to evaluate (searching for the optimal one) allows the designer to allocate larger time budget to the single evaluation and run even high-fidelity, computationally expensive models. Depending on the formulation of the optimization problem and the goal of the designer, the fidelity of the models within each optimization loop can be adjusted to the specific accuracy needs and time constraints; in the context of this paper, this methodology is implemented in a centralized machine; however, the evaluation of each architecture is not

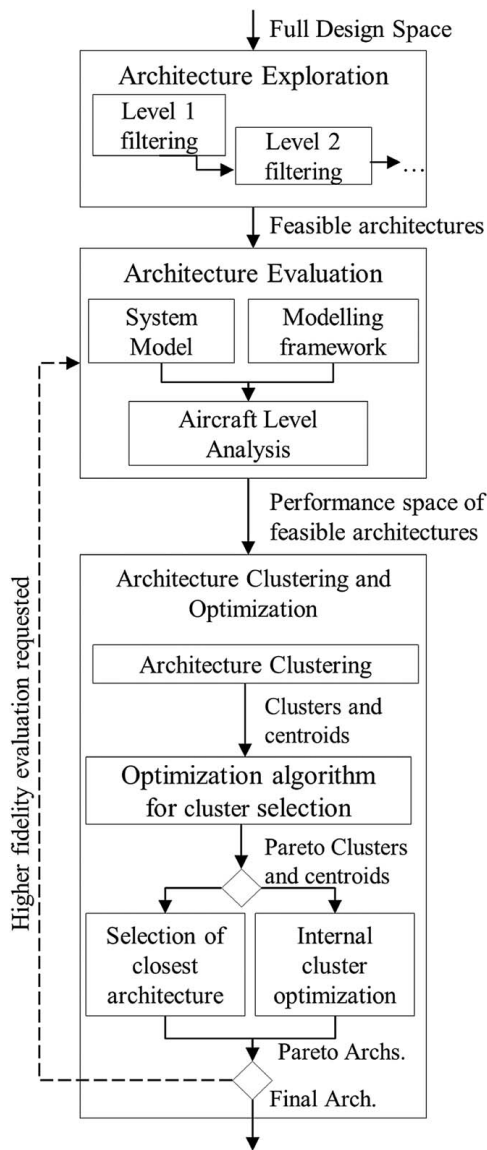

**Fig. 1** Flowchart schematic of the methodology implemented in this paper

dependent on the other and can be distributed across computing machines.

The selection of the models of different fidelity depends on the models available in the library, the size of the design space as an output of the different steps, and the computational effort available to the designer. The selection can be done manually by the designer based on an informed decision coming from each of the different steps in the methodology and can be automated taking into account the size of the solution space and the computational resources available. The scope of the work in this paper is to present a platform that enables this decision by including the library of models of different fidelity and a principled approach that guides the decision of when to switch from one level of fidelity to another.

**2.1 Architecture Exploration.** The design problems tackled by the proposed methodology are mathematically complex in nature, and for this reason, the methodology adopts in its first step the architecture enumeration and evaluation (AEE) method [57,58] developed at United Technologies Research Center. The AEE method provides a systematic, rigorous, and exhaustive exploration of the architecture design space for new architectures. The AEE procedure implements a multi-level filtering process (Fig. 2)

where the design space is adaptively reduced in successive refinement levels. The standard AEE implementation commonly includes two levels of successive filtering, but those can be extended to several more where the design space is overly large or the filtering metrics should be implemented in separate levels such as due to organizational concerns. In the first level, AEE uses an abstraction of the architecture space to rapidly explore it and identify feasible and infeasible solutions. The set of feasible solutions is further screened using higher fidelity analysis in the second level. A detailed description of the core procedure is provided by Zeidner et al. [58] and includes the enumeration of all possible architectures in the design space represented as abstracted system-technology combinations and a rapid and efficient generative filtering approach to pare down the design space by excluding those architectures that violate application-specific constraints and only generating those architectures that are feasible.

The framework proposed in this paper implements AEE at the first filtering level only. The goal is to identify a feasible collection of possible designs combining different technology solutions, different number of components, and different interconnection patterns between components. Many of the candidate architectures generated are found to be infeasible or violate regulatory norms, so the design space can be reduced by imposing constraints. There is no requirement imposed on the size of the design space after this exploration step, but rather the constraints imposed to ensure a reduction by eliminating all potential architectures that would not be physically compatible or otherwise feasible, for example, a mathematically possible architecture would connect an electrical actuator to the hydraulic system, but that is not physically compatible, therefore that architecture is not considered.

The implementation of these constraints ensures that redundancy rules are respected and that only feasible architectures are considered for more detailed evaluations. The reduction of the number of candidate architectures leads to a containment of the overall computational effort required for subsequent evaluation and optimization purposes. For the applications presented and discussed in this paper, we observe a reduction of three orders of magnitude, which still leaves a large pool of candidate configurations. A possible approach to further reduce the number of candidates is over-constraining; however, over-constraining might compromise a clear traceability to the higher-level requirements. Therefore, we proceed in a different way: the remaining feasible architectures are evaluated through the combination of the system-level models and the aircraft power platform in the next step.

**2.2 Architecture Evaluation.** The architecture evaluation starts once the design space has been initially reduced through the exploration step. The evaluation step calculates the first-cut set of results of the impact of the candidate architectures at system and subsystem level by building a complete model of the system using available low-fidelity models of the subsystems. The concept of performing the evaluation of the architecture first at a higher level is generic for any complex system architecture. However, the models and the model structure behind this calculation step are necessarily specific to the application. For the demonstration purposes of this paper, we implement this step, and the whole method, for the design of aircraft systems; therefore, the architecture evaluation engine is composed of models of the aircraft power systems.

This evaluation is necessary because in the next step (Sec. 2.3), the optimal architecture is selected based on the impact metrics at the aircraft level calculated through this step. This calculation is done using models of the power systems of the aircraft and a power platform which manages the interactions between them with regards to the power flows. Research in this area has focused on either a small number of options but with more detail on each of them [59,60], using model-based system engineering (MBSE) approaches to manage a large number of alternative architectures but with limited options per system [61,62] or using



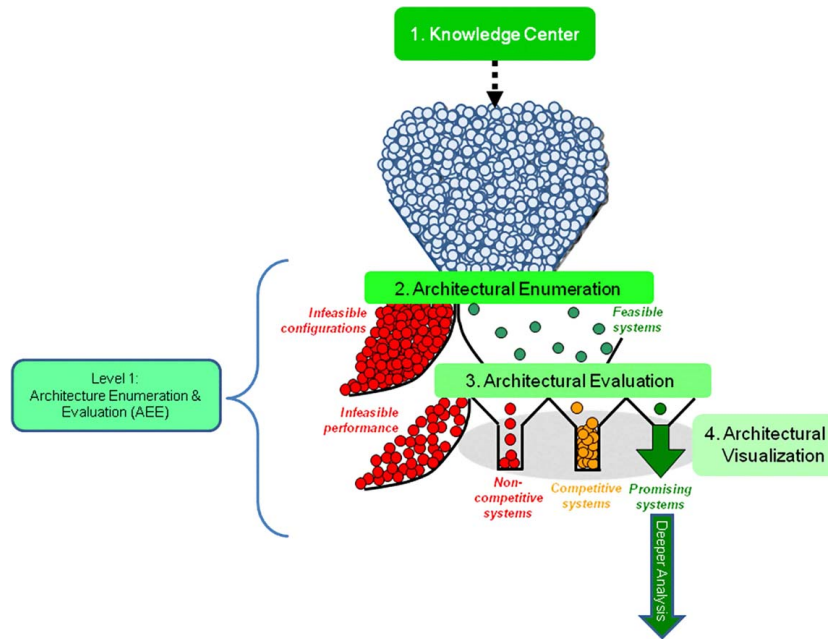

Fig. 2 Illustration of the AEE method [58] (Used with permission of UTRC copyright 2010)

heuristics to reduce the size of the design space to a small subset of architectures [63]. Some literature also focuses on the power distribution of the aircraft [64] and the specific problems of more-electric system architectures [65,66]. The strategy adopted in this paper aims at exploring the entire design space with a set of technology options in successive steps where the fidelity of the models to evaluate the systems varies as needed and capturing the downstream effects in other systems of the different technology options allowing for the flexibility to evaluate the integration of different technologies in different systems and domains.

Figure 3 presents a schematic of our modeling framework. Each of the dashed blocks is a system model implemented in the power

platform to capture the overall flow of different kinds of power and their impact on aircraft performance. The power platform includes a library of aircraft system models that represents all the critical aircraft functions in order to capture most of the effects of the technology change on the other aircraft systems and their interaction. The models for these different systems are realized at different levels of fidelity, including models composed of analytical equations, first-order approaches, historic data for conventional systems, data tables based on more complex models, and for later stages in this process, the more complex 0-D dynamic models themselves. The structure of the power platform is stored in Matlab and the different models are called in different tools and programming

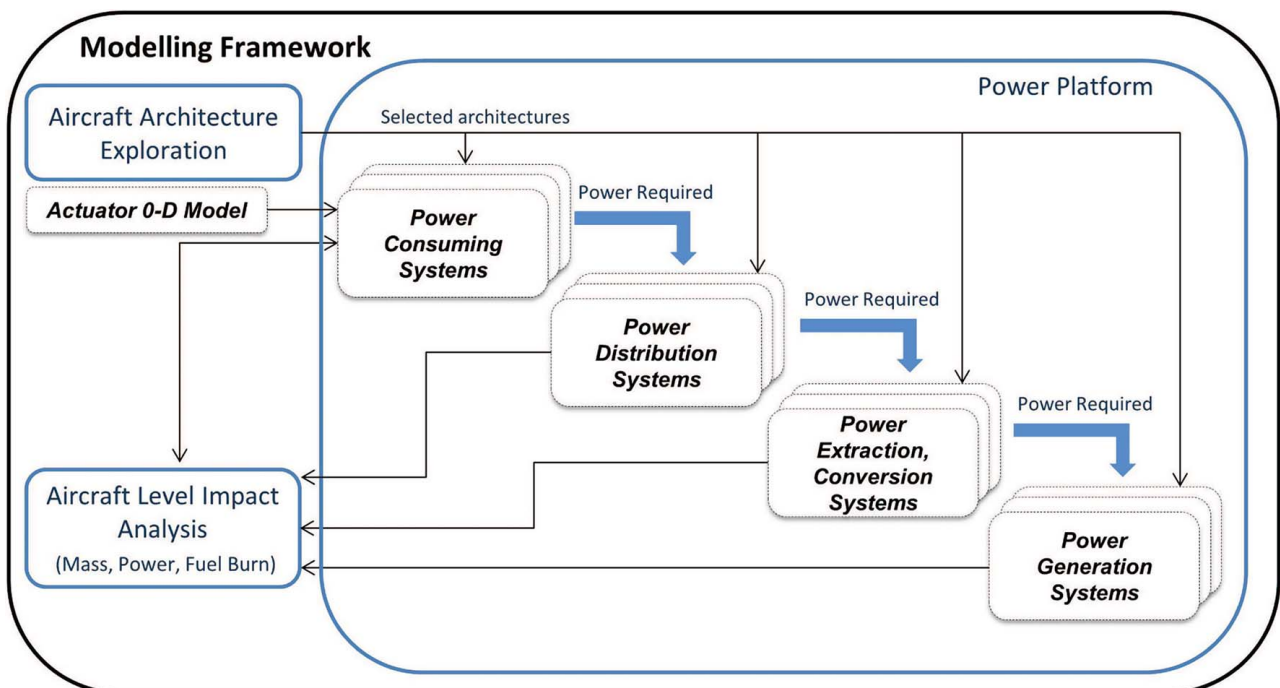

Fig. 3 Structure of the modelling framework

languages ranging from Microsoft Excel, Python, Matlab, or different Modelica tools such as SimulationX depending on the fidelity and whether they are legacy models or not. Each individual subsystem is represented by its own set of models with a consistent input and output structure and then built up to the full system following a modular approach. This results in a platform where for each specific system there is a dedicated library of models of different levels of fidelity that can be queried at different stages of the process.

In order to reduce the computational time, the fidelity of the models is the minimum necessary to capture the impact of the technology change. For most cases, this means that the model of the system where the technology change occurs has the most detail, while other system models are kept simple.

The performance assessment of each architecture relies on different system-level key performance indicators (KPIs) such as system volume and weight and their overall impact on aircraft performance. The aircraft level impact analysis considers the changes in mass and power flow in the different systems involved in the candidate architecture and calculates their impact on the weight, power balance, and fuel burn of the aircraft. The additional weight of fuel that needs to be carried and the updated system weight is fed-back to the power platform systems to update their performance requirements until the design converges to a final set of KPIs at aircraft level. For example, as the aircraft consumes more fuel, the fuel pump performance changes, and they extract a different amount of power from the engine which in turn changes the overall fuel burn, this causes a design loop that needs to converge to accurately represent the impact of the technology change on the aircraft performance.

The models of the individual systems in the power platform have to account for mass, geometry, electrical, or hydraulic performance, and mechanical performance of the different systems. This paper discusses two specific use cases, both dealing with the electrification of aircraft actuation functions. For both the cases, all the feasible architectures are compared against a baseline conventional aircraft configuration including all-hydraulic actuation and additional systems constituting what we refer to as the conventional configuration. The conventional configuration includes bleed-air based environmental control and ice protection systems, mechanical fuel pumps and other engine accessories, a fuel-burning auxiliary power unit (APU) and two turbofan engines. The changes in the actuation systems are considered to be the only change affecting the power consumption of a given architecture, with all the other power sinks fixed at the baseline configuration. While this paper focuses on the implementation of the methodology for this specific systems and demonstrating its performance, future implementations of this method will accommodate a larger number of choices in different systems to assess the compounding effects of changing several systems in a larger number of domains at once.

This performance assessment step requires models of the systems involved in aircraft operations in order to evaluate the architectures. In the context of the MISSION project, detailed dynamic models of the systems are being developed to study the system-level performance for design optimization, control design, and system integration [51]; most of the dynamic models are built in Modelica language, with the controls being designed in Matlab Simulink. The dynamic models of the actuation systems are integrated in the overall MISSION platform. For the application discussed in this paper, these detailed, high-fidelity models of the actuators are run offline and mapped into a look-up table, which are then read during simulation by the power platform. The simulation of the other aircraft systems acting as power sinks are run using low-fidelity models since they are not changing from the baseline: such simplifications do not negatively impact the solution and contribute to contain the associated computational effort.

The sizing constraints for the actuators are derived from regulatory load cases and maneuverability requirements [67,68]. The dynamic performance of an actuator is calculated for the standard mission phases where the actuator is acting. In addition, the power requirements during emergency operations (e.g., rejected takeoff and one-engine landing) drive the sizing of the subsystems

for power generation and transportation. Previous work demonstrated that the modeling framework used in this paper effectively captures the compound effects of changing multiple technological solutions and discussed implementation details for an actuation use case [53].

**2.3 Architecture Clustering and Optimization.** The architecture exploration step reduces the number of design options, several orders of magnitude, and enables the evaluation of the architectures. The evaluation step computes the KPIs at the aircraft level associated with the different candidate solutions. The objective of this step is to group the candidate architectures into clusters of similar performance and then identify the optimal architectures among them. We target this goal by leveraging machine learning techniques. The clustering step is beneficial because we expect that some of the small changes at system level amount to effectively negligible changes at aircraft level. In addition, at the conceptual design stage, many choices are confined to discrete option choices and the models do not have the detail granularity to capture significant impact among subtle differences in design; therefore, architectures are expected to group in well-segregated clusters in the aircraft KPI space. The co-located architectures in the KPI space that show significant similarities could be filtered in the previous step, thus reducing the design options to assess; but then, the family of feasible but dissimilar solutions would not be complete. The approach proposed in this section aims at retaining full visibility of the feasible architectures and manages their similarity by grouping similar architectures into sets of solutions after the initial evaluation step (Sec. 2.2).

We use machine learning to identify clusters of architectures as features in the space of the KPI. A variety of clustering techniques are proposed in the literature [69–71]. For the design of on-board aircraft systems, it is commonly observed that sets of architectures with similar components and minor differences in subsystem parameters behave very similar and clearly distinct from architectures including different technology options [53,60]. Therefore, we expect well-segregated clusters in the space of the KPIs; to learn and capture these structures, we adopt K-means. K-means is a machine learning technique commonly used for clustering purposes; it relies on a form of competitive learning to identify K groups of similar input data and compute the associated K centroids. We use K-means to group the  $n_{arch}$  architectures that survived the exploration and evaluation phases (Sec. 2.1 and 2.2) where we evaluated the corresponding KPI values with agile models, usually characterized by low-level of fidelity. Specifically, each architecture ( $\tau_i$ ) corresponds to a point in the performance space defined by its weight impact on the aircraft empty weight ( $Weight_i$ ), its impact on the secondary power extracted from the engine ( $PowerExt_i$ ), and its impact on the total fuel burn of the aircraft ( $FuelBurn_i$ ):

$$\tau_i = [FuelBurn_i, Weight_i, PowerExt_i], \quad i = 1, \dots, n_{arch} \quad (1)$$

Therefore, we can now assemble a training matrix  $T$  of input data for the K-mean algorithm to find (learn) their structure in the space of KPIs:

$$T = [\tau_1, \tau_2, \dots, \tau_{n_{arch}}]^T \quad (2)$$

During training, K-means assigns the architectures to a set of K clusters according to a similarity metric:

$$k^* = \operatorname{argmin}_{k \in \{1, \dots, K\}} \|\tau_i - c_k\|, \quad i = 1, \dots, n_{arch} \quad (3)$$

In Eq. (3),  $\tau_i$  is the  $i$ th architecture,  $c_k \in R^3$  is the centroid of the  $k$ th cluster and represents a point in the K-means input space (the KPI space);  $\|\tau_i - c_k\|$  denotes the Euclidean distance between the  $i$ th architecture and the  $k$ th centroid. Once training is complete, the vectors  $\{c_k\}_{k=1}^K$  represent the prototypes of the  $K$  clusters of architectures; each prototype averages the KPI values of the architectures within the associated cluster.

However, the number  $K$  of clusters is not known a priori. Our objective is to exploit the similarity between the different architectures to group them in different clusters, rather than separate them into predefined sets whose features would be hardly known in advance. Therefore, we adopt a particular implementation of the K-means proposed by Arthur and Vassilvitskii [72] that learns the number of clusters by iteratively updating  $K$  at each epoch.

The algorithm is initialized with a first guess of the minimum number of clusters  $K = K_0$ . For our implementation,  $K_0$  is set to meet the number of technology options, because we expect these to play a significant role and have a large impact on the performance (KPIs) of the systems. Then, a condition is introduced to determine whether or not incrementing the number of clusters is appropriate: if the distance between the centroid and the cluster members in any cluster  $k$  is less than a given similarity threshold,  $K$  clusters are considered sufficient to capture the structure of the input space; otherwise,  $K = K + 1$  and the learning continues until the condition is met. The threshold is set by the user and is defined upon considerations on the fidelity level of the models used to compute the KPIs.

The output of the clustering step is the final set of  $K$  cluster centroids  $\{c_k\}_{k=1}^K$  defined in the KPI space. The search of the optimal solution can now be conducted among the cluster centroids, with a sensitive reduction (from  $n_{arch}$  to  $K \ll n_{arch}$ ) of the number of candidates to assess and evaluate for the optimization task. Therefore, this machine learning-based step is crucial as it generates a smaller and more manageable amount of representative candidate solutions and permits the optimization task to complete more rapidly. In this way, the number of architecture configurations to evaluate and assess for the optimization step are reduced from  $n_{arch}$  to  $K$ .

The optimization problem is a multiobjective problem [73–76], where all the objectives need to be minimized. The objectives are three key performance indicators, namely, aircraft weight  $f_1$ , shaft power extracted from the engine  $f_2$ , and the fuel burn of the aircraft over the entire mission profile  $f_3$ . The multi-objective optimization problem is formulated as a single objective function combining the objectives according to a weighted sum approach. The optimization seeks, among the cluster centroids  $\{c_k\}_{k=1}^K$ , the one that minimizes the objective function:

$$\min_{c_k} \sum_{j=1}^3 \gamma_j f_j \quad (4)$$

where  $\gamma_j \geq 0$ ,  $j = 1, 2, 3$  are the weights associated with the KPI: these values encode objectives prioritization and assume values such that  $\sum_{j=1}^3 \gamma_j = 1$ . We wish to identify non-dominated solutions (Pareto front) among the cluster centroids and perform architecture trade-off studies in terms of KPIs. The Pareto front is generated by exploring the possible values for the weights using a genetic algorithm. The prioritization of objectives according to specific designer criteria determines the selection of the optimal solution within the Pareto set.

Cluster centroids that do not belong to the Pareto front are not possible solutions to the optimization problem and the architectures of those clusters are considered suboptimal. However, the optimal centroids on the Pareto front are not necessarily physical solutions to the original architecture choice problem. That is, they are not necessarily a real architecture that can be implemented at the aircraft level. There are two possible solutions to this problem. First, the closest point in the cluster to the centroid can be thought of as the representative real solution for that particular cluster. This occurs, for example, because the design choices that differentiate the architectures within the cluster are not known. However, this approach does not identify a rigorously optimal architecture: a better architecture might exist within the cluster, but further away from the centroid. The rigorous solution is to run a second optimization loop within the architectures of the cluster. This paper follows the latter approach.

Architecture clustering and the optimization step are introduced to find the optimal architectures according to the prioritization given by the user in a principled and efficient manner. In addition, it provides traceability from the objectives of the optimization function to the architecture sets, the individual architectures, all the way to the technology choices made in the very first step of the process. The progressive reduction of the number of candidate solutions to evaluate allows running higher fidelity models to predict architecture performance at a later stage. In fact, depending on the available computational budget and the specific approach chosen, high-fidelity models can be run for the representative architectures of each cluster or for all the architectures within the optimal cluster.

### 3 Problem Setup

The methodology proposed in this paper has been implemented for two use cases concerning the integrated design of an aircraft power system architecture. The two use cases cover the electrification of (1) the primary flight control system (PFCS) and (2) the landing gear braking system of a commercial aircraft. The interest for these use cases is motivated by the key role played by electric PFCS and electric braking in enabling the transition toward fully electric aircraft in the future. For this reason, more electric actuation is already onboard in recent aircrafts such as the A380, the B787, and the A350. To achieve the goal of flying with fully electric actuation, several technologies are identified as possible solutions, including electro-mechanical actuation (EMA), electro-hydrostatic actuation (EHA), and EHA as a backup system (EBHA) to a hydraulic actuator (as adopted by the A380 in the PFCS).

This work focuses first on the analysis and design of the primary flight control system in order to show the method and results. The paper then focuses on demonstrating the repeatability of the method for the second use case of the electric braking system. Both the use cases discussed in this paper are chosen to be the representative of a short-range, single-aisle aircraft, in the 150–200 passenger class.

At aircraft level, the values of model parameters are chosen for given aircraft configuration, size, geometry, and mission requirements, which in turn define size, geometry, and behavior constraints for the different systems and determine sets of performance requirements for the different design choices. An unconstrained exploration of a design space with multiple components, technology options, and interconnections generates a very large number of architectures to be considered. For example, both the use cases discussed in this paper present a number of actuators for which three or four technology options are available, in addition to a number of other components of the associated system and all their interconnections, leading to a large number of candidate architectures. To limit the number of architectures to evaluate, sets of feasibility and compatibility constraints are derived from the requirements defined at aircraft level and applied at system and component level.

The two large design spaces that characterize the use cases considered in this paper motivate the need for an efficient method to down-select feasible architecture configurations and enable their optimization based on multiple performance objectives. The methodological approach and the framework presented in Sec. 2 are applied to these two uses cases described in Secs. 3.1 and 3.2; the results are discussed in Secs. 4.1 and 4.2, respectively.

**3.1 Primary Flight Control System.** The first use case is the primary flight control system (PFCS) for which we adopted the configurations discussed by Brière et al. [77]. At system level on the PFCS, each control surface is moved by two or three actuators, each characterized by a different actuation technology, geometry, attachment characteristics, kinematics, aerodynamic loads, stroke, speed, etc. In particular, we consider the configuration illustrated in Fig. 4, which includes: four aileron actuators (two per surface), four elevator actuators (two per surface), and three rudder actuators. For the 11 actuators in all control surfaces and allowing



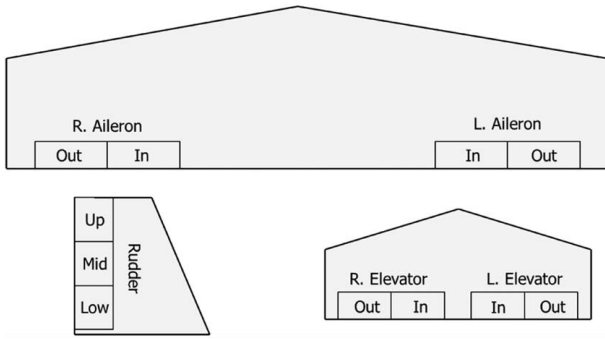

**Fig. 4 Primary Flight Control actuators configuration for the A320**

four technology options for each actuator, the design space includes at least  $4^{11}$  (in the order of  $10^6$ ) architectures. In addition to the actuation systems, the flight control system includes other components such as the flight control computers and the power sources, which increase the number of possible configurations and, in turn, lead to a large number of candidate architectures. This large number means that the evaluation and optimization of all of them are practically not feasible since these are computationally heavy steps.

However, not all the possible combinations are feasible and there are some constraints on the design problem that can be imposed in the architecture exploration stage. For the case of the PFCS, we adopt some of the constraints proposed by Bauer et al. [78]:

- The left and right aileron and elevator must be exactly symmetrical.
- Each actuator must be connected to the appropriate power source type: for instance, a SHA must be connected to a hydraulic power source, an EMA must be connected to an electric power source.
- Depending on the actuators in the architecture, an appropriate power source (hydraulic and/or electric) must be generated.
- Each actuator must be connected to at least one flight control computer and to a maximum of two FCCs.
- Each actuator must be connected to only one control surface;
- The actuators for each primary flight control surface must be of (at least) two different types.

These constraints allow for the design space to be reduced to the feasible architectures only, making subsequent evaluation steps computationally possible. In addition, some of these constraints are applicable for the second use case of the electrification of a landing gear brake described in Sec. 3.2.

**3.2 Landing Gear Braking System.** The type of aircraft considered for this use case is a short-range, single-aisle aircraft, like the A320 and the B737. This class of aircraft characteristically has two main landing gear struts with two wheels in each. Each of the wheels in the main landing gear includes a brake system. The brake system includes a stator-rotor assembly usually made of carbon. They perform the braking function by moving the stators into the rotors in a linear motion. This motion can be caused either by hydraulic cylinders or by electric actuators, currently varying in number from four to eight, see an example of the actuation architecture of four brakes in Fig. 5. Three technology choices are considered: SHA, EMA (which are already installed and flying in commercial aircraft), and an EHA option is also being explored. Since there are three design options for the actuators and anywhere from 16 to 32 actuators present in all the brakes, at least  $3^{16}$  architecture options (in the order of  $10^8$ ) plus several options for the controllers and the power line choices, the design space becomes really large as was the case for the PFCS.

Similarly to the preceding use case, many of the potential candidate architectures are not feasible or violate regulatory norms. In

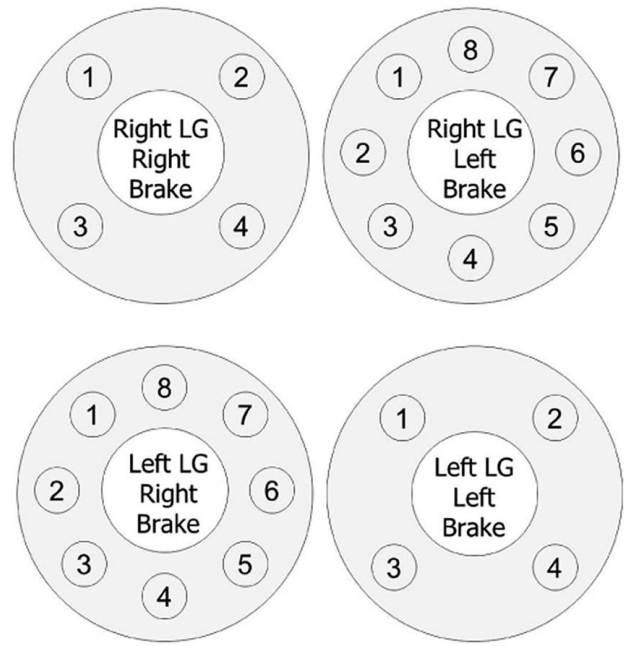

**Fig. 5 Braking system actuation case study setup**

order to reduce the design space to a feasible size, the following constraints are imposed:

- The left and right landing gear systems must be exactly symmetrical
- Each actuator must be connected to the appropriate power source type: for instance, an SHA must be connected to a hydraulic power source, an EMA must be connected to an electric power source;
- Depending on the actuators in the architecture, an appropriate power source (hydraulic and/or electric) must be generated;
- Each actuator must be connected to at least one brake controller and to a maximum of two brake controllers
- Each actuator must be connected to only one brake stator.
- Each brake has to include at least four actuators and no more than eight actuators.
- There has to exist at least two distinct power sources powering the actuators of a single brake.

In addition to these feasibility constraints, one practical commercial consideration is added: the brakes for all the wheels of the same kind of airplane should be identical. Brakes have to be replaced often due to wear and as such if the brakes are distinct, maintenance operations become much more expensive as several different part numbers have to be in stock. This consideration effectively reduces the problem to a single brake system design but its impact at the aircraft level is amplified because of the multiple instances of it.

The set of design options and the constraints imposed define the design space to be explored in the first step of the methodology and subsequently evaluated and optimized as explained in Sec. 2. Each of the use cases has a set of candidate architectures, and the results at each step of the methodology that will be detailed in Sec. 4.

## 4 Results

In this section, the results for both use cases described previously are presented. For the case of the PFCS, a more detailed description of the implementation of the methodology and its results are given. The same methodology is also applied to the landing gear case, the discussion on the second use case focuses on demonstrating that the same methodological framework can be used for different problems.

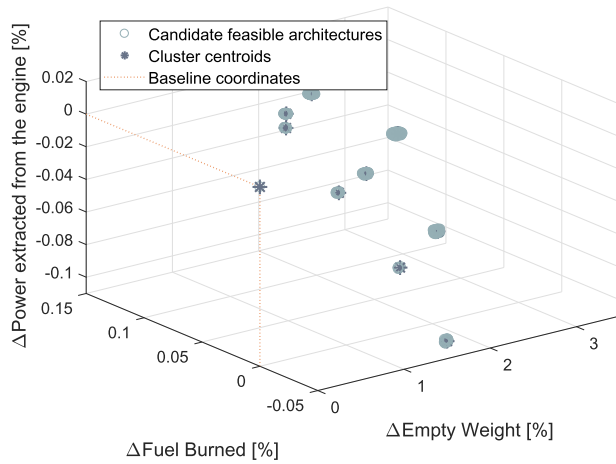

**Fig. 6 Feasible PFCS architecture 3D space and cluster centroids**

**4.1 Primary Flight Control System.** As described in Sec. 2, the first steps in the method are the exploration of the feasible architectures in the design space and then their evaluation according to their performance at the aircraft level. In the first step, the PFCS architecture design space is reduced from a design space of at least  $4^{11}$  (in the order of  $10^6$ ) to a design space in the order of  $10^3$ . Figure 6 illustrates the results obtained after these first two steps; the architectures are plotted in the 3D space of performance indicators (weight, fuel burn, and power extracted). All the results are presented as percentage change with respect to the baseline to measure the impact of a technology decision on the current configuration. There are thousands of architectures evaluated, but due to the size and impact of the system, a lot of their internal differences are nearly negligible at the aircraft level and there are segregated groupings. Significant changes among these architectures are major design choices like the actuators being different technology types or a significant enough change in the number of control computers or power connections used, for the most part, the difference among the architectures chosen are slight changes in routing from the architectures to the controllers and the power sources that constitute a change in the architecture but have a small impact at the aircraft level (i.e., EMA1 is connected to FCC1 and FCC2 or to FCC1 and FCC3).

For the K-means algorithm, one of the input parameters is the number of clusters to identify. The number of clusters is not known a priori. In 3D result space (Fig. 6), the data can be visualized and a first estimate of the number of clusters can be determined through direct observation. However, for higher dimensionality problems, the visualization of the results is difficult, and the clusters cannot be easily visualized and identified. To overcome this limitation, the K-means algorithm adopted for our studies iterates over different number of clusters (Sec. 2.3). The starting point of the iteration is the minimum given by the number of technology options, which is  $K_0 = 4$  (SHA, EHA, EBHA, EMA). The iteration proceeds to the next integer until the number of clusters  $K$  satisfies the requirements about in-cluster similarity computed in terms of sum of distances; this requirement on the sum of distances is set at 0.001. Each of the clusters defined by the K-means algorithm contains a subset of the original architectures with similar performances. Figure 6 depicts the cluster centroids and the assignment of the architectures to each cluster.

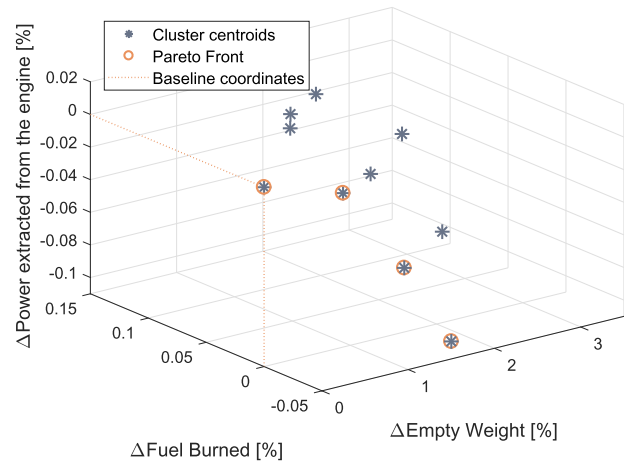

**Fig. 7 Pareto front of cluster centroids for PFCS**

A summary of the results of the different clusters can be found in Table 1; we can observe that not all clusters have the same cardinality or the same average distance. There is one cluster, ID# 8, which has a single member: this is the baseline architecture. The baseline architecture significantly differs from all the others such that if it were to be included into a different cluster, the sum of distances of that cluster would go over the desired limit. Once the clusters are defined, the number of solution candidates is reduced to cluster centroids; having the baseline in a separate cluster makes it coincident with its cluster centroid and includes it in the set of candidate solutions explored during the search for the optimal one.

Figure 7 depicts the results of the optimization process emphasizing the Pareto front of non-dominated cluster centroids. For this case, the front includes four cluster centroids, one of which is the baseline point at the (0, 0, 0) point in the graph.

The resulting cluster centroids do not necessarily represent real architectures that can be physically implemented. Therefore, we need to refine the selection to a real set of architectures identified by the architecture exploration step. A possible solution to this problem is to substitute the cluster centroids with the closest real architecture in the performance space and compute the optimal set (the Pareto front) over the real candidates. In this case, the set of optimal architectures in the Pareto front are real solutions and can be traced back in the original design space.

A drawback with this approach is that, although the closest point to the centroid is the most representative of the whole cluster, it might not be the overall optimum. Within the same cluster, there might be a point that has better performance with regards to the objectives. Figure 8 illustrates an example of this distribution occurring within a cluster. Depending on the point in the design process, the two solutions (optimal and closest) might be the same for the designer, because they both include the same combinations of technologies at the top level, and they only differ in small connections or slight geometrical differences. A designer at the conceptual design stage might not have the visibility and the granularity with regards to his/her knowledge of the integration in the aircraft. In this case, the choice of the real solution closest to the centroid represents the most efficient approach. In contrast, if that level of detailed knowledge is available, an extra discrete optimization loop to identify the best solution within the cluster is appropriate. In this paper, we demonstrate the latter approach. For the clusters in the optimal

**Table 1 PFCS cluster characteristics**

Cluster ID#	1	2	3	4	5	6	7	8	9	10
Cardinality	100	1000	1000	100	1000	10	1000	1	10	10
Sum of distances	$8.18E^{-7}$	$1.06E^{-6}$	$2.33E^{-6}$	$5.23E^{-7}$	$7.10E^{-7}$	$9.04E^{-8}$	$7.50E^{-7}$	0	$8.83E^{-9}$	$6.61E^{-6}$



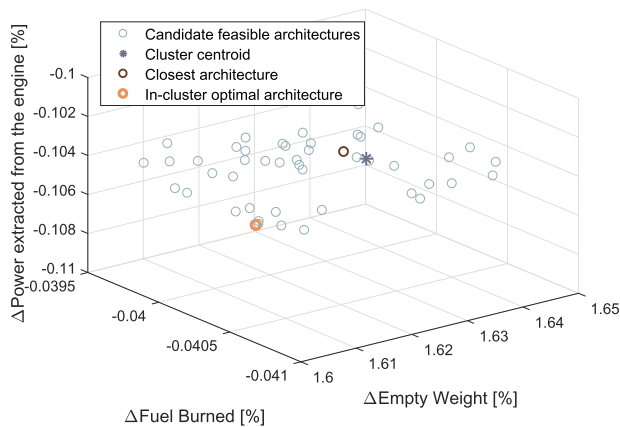

**Fig. 8 Cluster internal structure example**

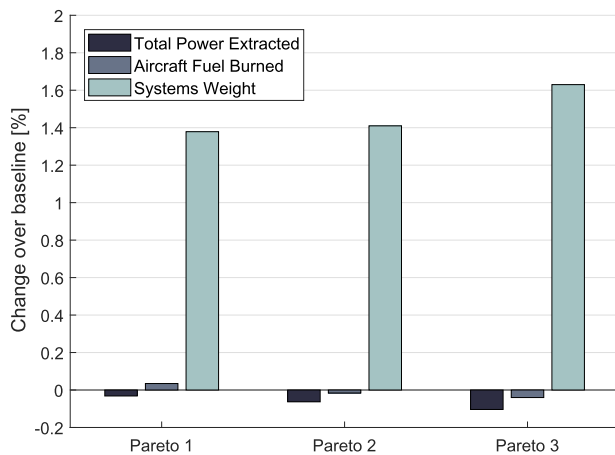

**Fig. 9 Performance of the architectures on the PFCS Pareto front**

set, we run internal optimization tasks to identify the optimal architecture within each cluster, except for the baseline architecture that constitutes a dominant cluster by itself. The baseline architecture is part of the optimal set because the hydraulic actuators are lighter than all electrical actuator options, and the all-hydraulic architecture is, therefore, lighter overall and dominates along the direction of the weight objective.

The performance of the optimal architectures is presented in Fig. 9. If the only objective was minimizing the weight, the baseline remains the optimal option. However, if the objective is to minimize either the power extracted or the fuel burn, the Pareto 3 architecture dominates other points, even though it is over 1.5% heavier than the baseline. Taking the objectives as equally weighted and ignoring the baseline solution, Pareto 2 is the optimal overall architecture since the weight penalty is not so severe as for Pareto 3 and largely offset by the reduction in the power extracted from the engine. The increase in engine efficiency means that the total fuel burn for the aircraft in this specific mission is slightly reduced; this reduction is relatively small as the performance estimates for the models are conservative in nature, and the benefit from the performance is offset by the increase in weight due to the actuators themselves as well as the increase in the mass of the electrical system. Details about what technology choices are included in each Pareto front architecture are listed in Table 2. Even if these technology choices belong to the optimal solution within each of the clusters, the technology solution of the rest of the architectures in the same cluster is very similar, only with slight changes in the location of the actuator or the routing of the power distribution lines.

Table 2 presents the details of the configuration of the three architectures in the Pareto front. The optimal architecture (Pareto 2) is a combination of EMA and EHA actuators in an all-electric actuation configuration for the main wing. The main wing all-electric configuration allows all the hydraulic lines feeding the actuation along the length of the wing to disappear and be replaced by wires which offsets the penalty in weight from the heavier actuators, whereas the hydraulic lines cannot disappear completely as they run the length of the fuselage because of the presence of the APU, and therefore, the benefit of an all-electric horizontal tail actuation system is reduced. Including all technology options allows for technology differentiation, a feasibility requirement, and provides a balance between the heavier but more power-efficient EMA and EHA, and the lighter SHA. For Pareto 3, the weight penalty in the electric actuators is too high to justify the increase in power efficiency and fuel burn with the current weights, and Pareto 1 includes SHAs to mitigate the weight penalty but are penalized for their lower power efficiency and the presence of hydraulic lines along the wing.

This solution only applies to the particular use case presented here, with the system models for each of the technology solutions fixed at certain conservative performance thresholds and the power platform adjusted for the particular aircraft performing a particular mission. Therefore, this specific solution cannot be extrapolated to other aircraft or other cases. However, the method can be applied to other technology solutions, expanding the design space to include other considerations such as maintenance and cost or it can be reformulated for the primary flight control distribution of other aircraft, considering their particular characteristics, and further trade studies can be carried out utilizing the same method.

This study demonstrates the capability of our methodology to perform an efficient selection of the optimal architecture from an initial set of design candidates in the order of  $10^6$  architectures. In particular, the optimal architecture outperforms the baseline with regards to power and fuel burn. In other studies, several architectures might be equally optimal depending on the importance of the objectives, but this framework is conceived to incorporate this flexibility and provide the necessary visibility to track which technology choices determine the optimal architectures. The framework also permits to manage system models characterized by different levels of fidelity and incorporates enough flexibility to provide solutions for similar problems but in different aircraft systems, different aircraft, or different missions.

**4.2 Landing Gear Braking System.** The brake system architecture design space is reduced from a design space of at least  $3^{16}$  (3 actuator options, 16 actuator locations), in the order of  $10^8$  architectures, to a brake design space in the order of  $10^2$  just in the first step of the methodology, the architecture exploration step. The hundreds of candidate architectures are then evaluated and visualized according to the KPIs given through the use of the same evaluation platform as described in the previous use case. Similarly to the PFCS use case, the architectures present in Fig. 10 are tightly grouped due to the limited impact of a small change in the braking system in the overall aircraft performance space.

Following the same process as for the PFCS, the architectures are then grouped in 13 clusters of similarly performing architectures. This number of clusters is reached after setting the iterative K-means to iterate until the similarity metric, sum of distances, is less than 0.001 as in the case of the PFCS. Figure 11 illustrates the resulting performance space. We can distinguish three broad groups of clusters in the space of KPIs (indicated with circles): (1) the baseline that constitutes a single point cluster; (2) another group formed by architectures with higher number of actuators and more traditional actuator technology options; (3) a third group of better performing clusters that is composed of architectures with a smaller number of actuators but more changes in the technology options of the actuators. The Pareto front of non-dominated architecture cluster has also been calculated and illustrated in

**Table 2 Optimal PFCS architecture technology solution**

Architecture	Aileron in	Aileron out	Elevator in	Elevator out	Rudder up	Rudder mid	Rudder down
Pareto 1	SHA	SHA	EHA	EMA	SHA	SHA	EMA
Pareto 2	EMA	EHA	SHA	EHA	EMA	EHA	EMA
Pareto 3	EMA	EMA	EHA	EHA	EMA	EHA	EMA

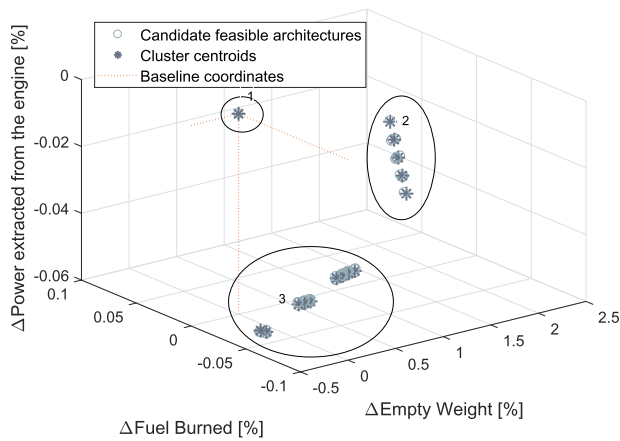

**Fig. 10 Braking system feasible architecture 3D space**

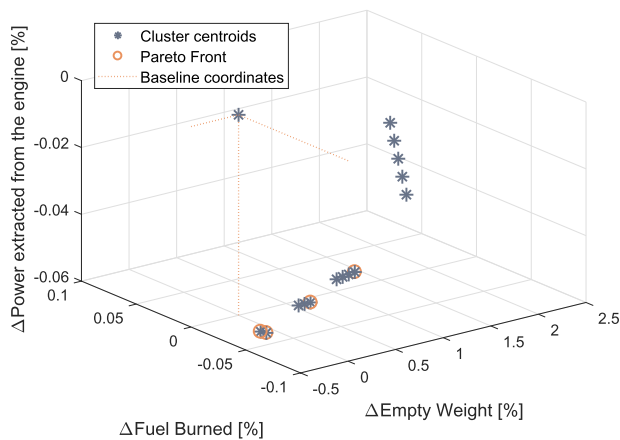

**Fig. 11 Pareto front of braking system architecture clusters**

**Table 3 Optimal landing gear braking actuation architecture technology solution**

Architecture	Brake top	Brake right	Brake left	Brake bottom
Pareto 1	SHA	SHA	EHA	SHA
Pareto 2	SHA	SHA	EMA	SHA
Pareto 3	SHA	SHA	EMA	EMA
Pareto 4	SHA	EMA	EMA	EMA

Fig. 11 with a linear surface interpolating between the four Pareto cluster centroids. Two other architecture cluster centroids in the third group are very close to the Pareto front but are dominated by the Pareto points.

The clusters in the Pareto front are further subject to the internal optimization process, as done for the PFCS use case, and the optimal architectures within them are selected as representative Pareto front architectures. The technology choices present in each of them are detailed in Table 3. All the architectures in the Pareto front presented in Table 3 are hybrid architectures as the compound

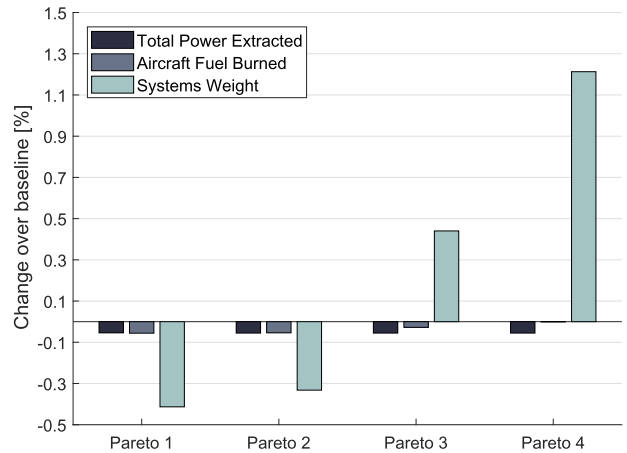

**Fig. 12 Performance of the brake architectures on the Pareto front**

benefits of eliminating the hydraulic power system from the aircraft are not considered for this study.

Figure 12 presents the performance of each of these architectures. The architectures in the Pareto front perform better than the baseline for power extracted and fuel burn; two of them (Pareto 1 and 2) are also lighter. Even though the electric actuators are heavier than the original hydraulic, the reduction in the size of the hydraulic system offsets this increase in weight and actually produces weight benefits when only one electric actuator is present. As expected, upon the results observed for the flight control case study (Sec. 4.1), the power performance of the electric actuators is better than for the hydraulic, with the EMAs outperforming the EHAs. Still, the EMA improvement in performance is enough to provide benefits with regards to fuel burn even with its larger weight, although the improvement in terms of fuel burn is less than 0.1% and therefore, largely negligible. This is due to the fact that, unlike the PFCS, the braking system is only active in the ground portions of the mission, and the only operation point where its power consumption is significant is during landing. This means that the penalty for carrying extra weight affects the whole mission whereas the benefit of the lower power consumption is only present for the small window of time during landing, showing how for this application the framework assists the designer in informing their choices earlier in the design process.

## 5 Conclusions

This paper proposes a procedure to assist the system optimization at early design stages accounting for significant changes in technology at the system level and their impact on aircraft performance. The process was demonstrated for the electrification of the PFCS and the braking system of a short-range aircraft. The impact of the different technological options at aircraft level is measured in terms of changes in empty weight, fuel burn, and power extracted (KPIs) with respect to the conventional architecture. The process presented in this paper is extendable to a broad spectrum of similar problems requiring an early assessment of system technology impact on aircraft configuration and performance.

The procedure combines a first-level filtering (that sensitively reduces the number of possible solutions) with an architecture localization process (that further reduces the cardinality of the solution candidates). The methodology follows three steps, each reducing the number of candidate architectures of several orders of magnitude. The cardinality of the design options is reduced from  $10^6$  to  $10^3$  in the exploration phase, then to  $10^1$  in the clustering stage, and eventually to the single best architecture picked in the Pareto front according to the designer's objective prioritization. The incremental approach to architecture screening leads to a reduction in the overall computational time associated with the optimization task (as less architectures have to be analyzed) and permits to allocate a larger time budget for analysis and simulation (for the use of higher-fidelity models). The overall framework permits the traceability of the performance of all the results back to the original requirements and technology choices and allows the decision-maker to prioritize objectives according to their needs.

The process was demonstrated for the electrification of the PFCS and the braking system of a short-range aircraft. The impact of the different technological options at aircraft level is measured in terms of changes in empty weight, fuel burn, and power extracted (KPIs) with respect to the conventional architecture. The general method proposed in this paper can be extended to design problems accounting for a broader spectrum of KPIs including cost, reliability, maintainability, and manufacturing ease. This requires additional specific model libraries to be added to the modeling platform. For instance, reliability assessment requires fault hazard analyses to be conducted for each candidate configurations; cost considerations require models that often rely on proprietary information of the manufacturers and that can be included as black boxes or historical estimates. Future avenues of development would include a broader set of KPIs, the integration of surrogate models in the later optimization steps along with further strategies to intelligently manage variable fidelity in the models at different stages in the process.

## Acknowledgment

This work was supported by the Clean Sky 2 Joint Undertaking Grant No. CS2-SYS-GAM-2014-2015-01 under the European Union Horizon 2020 Research and Innovation Program and by the IDA Center of Excellence in Cyber Physical Systems Grant No. 176474 under the Industrial Development Agency (Ireland) program. The authors would like to thank Dr. Larry Zeidner, Dr. Deepak Mehta, Mrs. Blanca Florentino, Dr. Brian St. Rock, and Mr. Simone Tumiatì for the fruitful interactions on different parts of the methodology.

## Nomenclature

ACARE	= Advisory Council for Aeronautics Research in Europe
AEE	= architecture enumeration and evaluation
APU	= auxiliary power unit
EBHA	= electric backup hydrostatic actuator
EHA	= electro-hydrostatic actuator
EMA	= electro-mechanical actuator
KPI	= key performance indicators
LG	= landing gear
MBSE	= model-based system engineering
MDO	= multidisciplinary design optimization
MISSION	= Modelling and Simulation tools for Systems Integration on Aircraft
PFCS	= primary flight control system
SHA	= servo-hydraulic actuator

## References

[1] European Aviation Safety Agency (EASA), 2016, "European Aviation Environmental Report," <http://www.easa.europa.eu/caer/>, Accessed September 30, 2017.

[2] Advisory Council for Aeronautics Research in Europe (ACARE), 2017, "Strategic Research and Innovation Agenda," Executive Summary. <http://www.acare4europe.org/>, Accessed September 30, 2017.

[3] European Union, 2017, "Clean Sky 2," <http://www.cleansky.eu/>, Accessed May 31, 2017.

[4] Value Improvement Through a Virtual Aeronautical Collaborative Enterprise (VIVACE), 2011, "Final Report Summary." <http://cordis.europa.eu/result/rcn/47814>, Accessed May 31, 2017.

[5] More Open Electrical Technologies (MOET), 2011, "Project Details." <http://cordis.europa.eu/project/rcn/814721>, Accessed May 31, 2017.

[6] Thermal Overall Integrated Conception of Aircraft (TOICA), 2017, "Final Report Summary." <http://cordis.europa.eu/project/rcn/110079>, Accessed May 31, 2017.

[7] ACROSS, 2017, "Advanced Cockpit for Reduction Of Stress and Workload." <https://cordis.europa.eu/project/rcn/106358/en>, Accessed June 30, 2019.

[8] Collaborative and Robust Engineering using Simulation Capability Enabling Next Design Optimisation (CRESCENDO), 2013, "Final Report Summary." <http://cordis.europa.eu/result/rcn/140562>, Accessed May 30, 2017.

[9] Valdivia-Guerrero, V., Foley, R., Rivero, S., Govindaraju, P., Elsheikh, A., Mangeruca, L., Burgio, G., Ferrari, A., Gottschall, M., Blochwitz, T., Bloch, S., Taylor, D., Hayes-McCoy, D., and Himmler, A., 2016, "Modelling and Simulation Tools for Systems Integration on Aircraft," SAE Technical Paper 2016-01-2052, SAE International.

[10] Blochwitz, T., Otter, M., Arnold, M., Bausch, C., Elmqvist, H., Junghanns, A., Mauß, J., Monteiro, M., Neidhold, T., Neumerkel, D., Olsson, S., H., Peetz, J.-V., and Wolf, S., 2011, "The Functional Mockup Interface for Tool Independent Exchange of Simulation Models," Proceedings of the Eighth International Modelica Conference, Mar. 20–22; Technical University, Dresden, Germany, no. 063, Linköping University Electronic Press, pp. 105–114.

[11] Blochwitz, T., Otter, M., Akesson, J., Arnold, M., Clauss, C., Elmqvist, H., Friedrich, M., Junghanns, A., Mauss, J., Neumerkel, D., Olsson, H., and Viel, A., 2012, "Functional Mockup Interface 2.0: The Standard for Tool Independent Exchange of Simulation Models," Proceedings of the Ninth International MODELICA Conference, Munich, Germany, Sept. 3–5, No. 076, Linköping University Electronic Press, pp. 173–184.

[12] Sobieszczanski-Sobieski, J., and Haftka, R. T., 1997, "Multidisciplinary Aerospace Design Optimization: Survey of Recent Developments," *Struct. Optim.*, **14**(1), pp. 1–23.

[13] Agte, J., De Weck, O., Sobieszczanski-Sobieski, J., Arendsen, P., Morris, A., and Spieck, M., 2010, "MDO: Assessment and Direction for Advancement—An Opinion of One International Group," *Struct. Multidisciplinary Optim.*, **40**(1–6), pp. 17–33.

[14] Martins, J. R., and Lambe, A. B., 2013, "Multidisciplinary Design Optimization: a Survey of Architectures," *AIAA J.*, **51**(9), pp. 2049–2075.

[15] Tfaily, A., Huynh, K., Piperni, P., and Liscouet-Hanke, S., 2013, "Landing Gear Integration in an Industrial Multi-Disciplinary Optimization Environment," SAE Technical Paper 2013-01-2319, SAE International.

[16] Mainini, L., and Maggiore, P., 2012, "Multidisciplinary Integrated Framework for the Optimal Design of a Jet Aircraft Wing," *Int. J. Aerospace Eng.*, **2012**, pp. 1–9.

[17] Gamboa, P., Vale, J., and Suleman, A., 2009, "Optimization of a Morphing Wing Based on Coupled Aerodynamic and Structural Constraints," *AIAA J.*, **47**(9), pp. 2087–2104.

[18] Park, C., Joh, C.-Y., and Kim, Y.-S., 2009, "Multidisciplinary Design Optimization of a Structurally Nonlinear Aircraft Wing Via Parametric Modeling," *Int. J. Precision Eng. Manuf.*, **10**(2), pp. 87–96.

[19] Bartoli, N., Lefebvre, T., Dubreuil, S., Olivanti, R., Bons, N., Martins, J., Bouhleb, M.-A., and Morlier, J., 2017, "An Adaptive Optimization Strategy based on Mixture of Experts for Wing Aerodynamic Design Optimization," 18th AIAA/ISSMO Multidisciplinary Analysis and Optimization Conference, June 5–9, p. 4433.

[20] Lefebvre, T., Bartoli, N., Dubreuil, S., Panzeri, M., Lombardi, R., D'ippolito, R., Della Vecchia, P., Nicolosi, F., and Ciampa, P. D., 2017, "Methodological Enhancements in MDO Process Investigated in the Agile European Project," 18th AIAA/ISSMO Multidisciplinary Analysis and Optimization Conference, Denver CO, June 5–9, p. 4140.

[21] Prakasha, P. S., Della Vecchia, P., Ciampa, P., Ciliberti, D., Charbonnier, D., Jungo, A., Fioriti, M., Boggero, L., Mirzoyan, A., Anisimov, K., Zhang, M., and Voskuijl, M., 2018, "Model based Collaborative Design and Optimization of Blended Wing Body Aircraft Configuration: Agile Eu Project," 2018 Aviation Technology, Integration, and Operations Conference, Atlanta GA, June 25–29, p. 4006.

[22] Roy, S., Crossley, W. A., Davendralingam, N., and Govindaraju, P., 2017, "Aircraft Design Optimization for Commercial Air Travel Under Multi-Domain Uncertainties," 58th AIAA/ASCE/AHS/ASC Structures, Structural Dynamics, and Materials Conference, Grapevine, TX, Jan. 9–13, p. 0127.

[23] Tfaily, A., and Kokkolaras, M., 2018, "Integrating Air Systems in Aircraft Multidisciplinary Design Optimization," 2018 Multidisciplinary Analysis and Optimization Conference, Atlanta, GA, June 25–29, p. 3742.

[24] Robinson, T., Eldred, M., Willcox, K., and Haimes, R., 2008, "Surrogate-based Optimization Using Multifidelity Models with Variable Parameterization and Corrected Space Mapping," *AIAA J.*, **46**(11), pp. 2814–2822.

[25] March, A., and Willcox, K., 2012, "Provably Convergent Multifidelity Optimization Algorithm Not Requiring High-Fidelity Derivatives," *AIAA J.*, **50**(5), pp. 1079–1089.

[26] Böhnke, D., Nagel, B., and Gollnick, V., 2011, "An Approach to Multi-Fidelity in Conceptual Aircraft Design in Distributed Design Environments," Aerospace Conference, Big Sky, MT, Mar. 5–12, IEEE, IEEE, New York, pp. 1–10.

[27] Zadeh, P. M., and Toropov, V. V., 2002, "Multi-Fidelity Multidisciplinary Design Optimization based on Collaborative Optimization Framework," Ninth AIAA/



- ISSMO Symposium on Multidisciplinary Analysis and Optimization, Atlanta, GA, Sept. 4–6, p. 5504.
- [28] Alexandrov, N. M., and Lewis, R. M., 2002, “Analytical and Computational Aspects of Collaborative Optimization for Multidisciplinary Design,” *AIAA J.*, **40**(2), pp. 301–309.
- [29] MacDonald, T., Clarke, M., Botero, E. M., Vegh, J. M., and Alonso, J. J., 2017, “SUAVE: An Open-Source Environment Enabling Multi-Fidelity Vehicle Optimization,” 18th AIAA/ISSMO Multidisciplinary Analysis and Optimization Conference, Denver CO, June 5–9, p. 4437.
- [30] Clark, D. L., Makas, A., and Grandhi, R. V., 2017, “Status of Multifidelity Model Management Strategies in Aircraft Design,” 18th AIAA/ISSMO Multidisciplinary Analysis and Optimization Conference, Denver CO, June 5–9, p. 4431.
- [31] Bryson, D., Rumpfkeil, M., and Durscher, R., 2017, “Framework for Multifidelity Aeroelastic Vehicle Design Optimization,” 18th AIAA/ISSMO Multidisciplinary Analysis and Optimization Conference, Denver CO, June 5–9, p. 4322.
- [32] Fioriti, M., Boggero, L., Corpino, S., Isyanov, A., Mirzoyan, A., Lombardi, R., and D’Ippolito, R., 2017, “Automated Selection of the Optimal On-Board Systems Architecture within MDO Collaborative Environment,” 18th AIAA/ISSMO Multidisciplinary Analysis and Optimization Conference, Denver CO, June 5–9, p. 3150.
- [33] Peherstorfer, B., Willcox, K., and Gunzburger, M., 2018, “Survey of Multifidelity Methods in Uncertainty Propagation, Inference, and Optimization,” *SIAM Rev.*, **60**(3), pp. 550–591.
- [34] Chaudhuri, A., Jasa, J., Martins, J., and Willcox, K. E., 2018, “Multifidelity Optimization Under Uncertainty for a Tailless Aircraft,” 2018 AIAA Non-Deterministic Approaches Conference, Kissimmee, FL, Jan. 8–12, p. 1658.
- [35] Ariyarat, A., Sugiura, M., Tanabe, Y., and Kanazaki, M., 2018, “Hybrid Surrogate-Model-Based Multi-Fidelity Efficient Global Optimization Applied to Helicopter Blade Design,” *Eng. Optim.*, **50**(6), pp. 1016–1040.
- [36] Zhang, Y., Kim, N. H., Park, C., and Haftka, R. T., 2018, “Multifidelity Surrogate Based on Single Linear Regression,” *AIAA J.*, **56**(12), pp. 4944–4952.
- [37] Simpson, T. W., Poplinski, J., Koch, P. N., and Allen, J. K., 2001, “Metamodels for Computer-based Engineering Design: Survey and Recommendations,” *Eng. Comput.*, **17**(2), pp. 129–150.
- [38] Kotsiantis, S. B., Zaharakis, I., and Pintelas, P., 2007, “Supervised Machine Learning: A Review of Classification Techniques,” *Emerging Artif. Intell. Appl. Comput. Eng.*, **160**, pp. 3–24.
- [39] Gorissen, D., Couckuyt, I., Demeester, P., Dhaene, T., and Crombecq, K., 2010, “A Surrogate Modeling and Adaptive Sampling Toolbox for Computer Based Design,” *J. Mach. Learn. Res.*, **11**(Jul), pp. 2051–2055.
- [40] Shan, S., and Wang, G. G., 2010, “Survey of Modeling and Optimization Strategies to Solve High-Dimensional Design Problems With Computationally-Expensive Black-Box Functions,” *Struct. Multidisciplinary Optim.*, **41**(2), pp. 219–241.
- [41] Basudhar, A., and Missoum, S., 2008, “Adaptive Explicit Decision Functions for Probabilistic Design and Optimization Using Support Vector Machines,” *Comput. Struct.*, **86**(19–20), pp. 1904–1917.
- [42] Han, Z.-H., and Görtz, S., 2012, “Hierarchical Kriging Model for Variable-Fidelity Surrogate Modeling,” *AIAA J.*, **50**(9), pp. 1885–1896.
- [43] Perdikaris, P., Venturi, D., Royston, J. O., and Karniadakis, G. E., 2015, “Multi-Fidelity Modelling Via Recursive Co-kriging and Gaussian-Markov Random Fields,” *Proc. R. Soc. A: Math., Phys. Eng. Sci.*, **471**(2179), p. 20150018.
- [44] Shahan, D. W., and Seepersad, C. C., 2012, “Bayesian Network Classifiers for Set-Based Collaborative Design,” *ASME J. Mech. Des.*, **134**(7), p. 071001.
- [45] Patel, J., and Choi, S.-K., 2012, “Classification Approach for Reliability-Based Topology Optimization Using Probabilistic Neural Networks,” *Struct. Multidisciplinary Optim.*, **45**(4), pp. 529–543.
- [46] Jelev, N., Keane, A., Holden, C., and Söbester, A., 2017, “Rule Based Architecture for Collaborative Multidisciplinary Aircraft Design Optimisation,” *World Acad. Sci., Eng. Technol., Int. J. Mech., Aerospace, Ind., Mechatron. Manuf. Eng.*, **11**(5), pp. 1014–1023.
- [47] Min, A. T. W., Sagarna, R., Gupta, A., Ong, Y.-S., and Goh, C. K., 2017, “Knowledge Transfer Through Machine Learning in Aircraft Design,” *IEEE Comput. Intelligence Mag.*, **12**(4), pp. 48–60.
- [48] Chaudhuri, A., Lam, R., and Willcox, K., 2018, “Multifidelity Uncertainty Propagation Via Adaptive Surrogates in Coupled Multidisciplinary Systems,” *AIAA J.*, **56**(1), pp. 235–249.
- [49] McCall, T., Seyed Alavi, K., Rana, L., and Chudoba, B., 2018, “Artificial Intelligent Research Assistant for Aerospace Design Synthesis–Solution Logic,” 22nd AIAA International Space Planes and Hypersonics Systems and Technologies Conference, Orlando, FL, Sept. 17–19, p. 5387.
- [50] Bonfiglio, L., Royston, J. O., and Karniadakis, G., 2018, “Multi-Disciplinary Risk-Adaptive Design of Super-Cavitating Hydrofoil,” 2018 AIAA Non-Deterministic Approaches Conference, Kissimmee, FL, Jan. 8–12, p. 1177.
- [51] Cimmino, N., Ponnusamy, S. S., García Garriga, A., and Mainini, L., 2019, “A Modelling and Simulation Framework for the Integrated Design of Aircraft Systems,” *Proc. Inst. Mech. Eng., Part G: J. Aerospace Eng.*
- [52] Burgio, G., Mangeruca, L., Ferrari, A., Carloni, M., Valdivia-Guerrero, V., Albiol-Tendillo, L., Govindaraju, P., Gottschall, M., Oelsner, O., Reglitz, S., Stavesand, J. E., Himmler, A., and Yapi, L., 2017, “Framework for Modelling and Simulation of Multi-Physics Aircraft Systems with Distributed Electronic Controllers,” *SAE Technical Paper 2017-01-2115*, SAE International.
- [53] García Garriga, A., Govindaraju, P., Ponnusamy, S. S., Cimmino, N., and Mainini, L., 2018, “A Modelling Framework to Support Power Architecture Trade-off Studies for More-electric Aircraft,” *Transport. Res. Proc., Special Issue: Aerospace Europe CEAS 2017 Conference*, **29**, pp. 146–156.
- [54] Cao, W., Mecrow, B. C., Atkinson, G. J., Bennett, J. W., and Atkinson, D. J., 2012, “Overview of Electric Motor Technologies Used for More Electric Aircraft (MEA),” *IEEE Trans. Ind. Electron.*, **59**(9), pp. 3523–3531.
- [55] Wheeler, P., and Bozhko, S., 2014, “The More Electric Aircraft: Technology and Challenges,” *IEEE Electrification Mag.*, **2**(4), pp. 6–12.
- [56] Sarlioglu, B., and Morris, C. T., 2015, “More Electric Aircraft: Review, Challenges, and Opportunities for Commercial Transport Aircraft,” *IEEE Trans. Transport. Electrification*, **1**(1), pp. 54–64.
- [57] Becz, S., Pinto, A., Zeidner, L., Khire, R., Reeve, H., and Banaszuk, A., 2010, “Design System for Managing Complexity in Aerospace Systems,” 10th AIAA Aviation Technology, Integration, and Operations (ATIO) Conference, Fort Worth, TX, Sept. 13–15, p. 9223.
- [58] Zeidner, L. E., Rock, B., Desai, N., Reeve, H. M., and Strauss, M. P., 2010, “Application of a Technology Screening Methodology for Rotorcraft Alternative Power Systems,” 48th AIAA Aerospace Sciences Meeting, Orlando, FL, Jan. 4–7, pp. 2010–1505.
- [59] Liscouët-Hanke, S., Mare, J., and Pufe, S., 2009, “Simulation Framework for Aircraft Power System Architecting,” *J. Aircraft*, **46**(4), pp. 1375–1380.
- [60] Lammering, T., and Stumpf, E., 2014, “Integration of Aircraft Systems into Conceptual Design Synthesis,” Technical Report, Lehrstuhl und Institut für Luft- und Raumfahrtssysteme (ILR).
- [61] De Tenorio, C., Armstrong, M., and Mavris, D., 2009, “Architecture Subsystem Sizing and Coordinated Optimization Methods,” 47th AIAA Aerospace Sciences Meeting Including The New Horizons Forum and Aerospace Exposition, Orlando, FL, Jan. 5–8, p. 37.
- [62] Armstrong, M. J., 2011, “Identification of Emergent Off-Nominal Operational Requirements During Conceptual Architecting of the More Electric Aircraft,” Ph.D. thesis, Georgia Institute of Technology, Atlanta, GA.
- [63] Chakraborty, I., Mavris, D. N., Emeneth, M., and Schneegans, A., 2016, “An Integrated Approach to Vehicle and Subsystem Sizing and Analysis for Novel Subsystem Architectures,” *Proc. Inst. Mech. Eng., Part G: J. Aerospace Eng.*, **230**(3), pp. 496–514.
- [64] Xia, X., 2011, “Dynamic Power Distribution Management for all Electric Aircraft,”
- [65] Kim, J., Kwon, K., Roy, S., Garcia, E., and Mavris, D. N., 2018, “Megawatt-Class Turboelectric Distributed Propulsion, Power, and Thermal Systems for Aircraft,” 2018 AIAA Aerospace Sciences Meeting, Kissimmee, FL, Jan. 8–12, p. 2024.
- [66] Craisse, J., Krüger, S., Kim, Y. J., Chakraborty, I., Briceno, S., Li, Y., Garcia, E., and Mavris, D., 2016, “Creation of a Decision-Support Methodology for Selecting More-Electric Aircraft Subsystem Technologies,” Systems Conference (SysCon), 2016 Annual IEEE, Orlando, FL, Apr. 18–21, IEEE, New York, pp. 1–7.
- [67] Regulations, Federal Aviation Authority, 2017, “Airworthiness Standards: Transport Category Airplanes.” <http://www.ecfr.gov>. Accessed September 30, 2017.
- [68] European Aviation Safety Agency (EASA), 2017, “Acceptable Means of Compliance for Large Aeroplanes CS-25, Amendment 19.” <http://www.easa.europa.eu/document-library/certification-specifications>. Accessed September 30, 2017.
- [69] Xu, R., and Wunsch, D., 2005, “Survey of Clustering Algorithms,” *IEEE Trans. Neural Networks*, **16**(3), pp. 645–678.
- [70] Steinbach, M., Karypis, G., and Kumar, V., 2000, “A Comparison of Document Clustering Techniques,” *KDD Workshop on Text Mining*, Vol. 400, Boston, MA, Aug. 20–23, pp. 525–526.
- [71] John Lu, Z., 2010, “The Elements of Statistical Learning: Data Mining, Inference, and Prediction,” *J. R. Stat. Soc. Ser. A (Stat. Soc.)*, **173**(3), pp. 693–694.
- [72] Arthur, D., and Vassilvitskii, S., 2007, “K-Means++: The Advantages of Careful Seeding,” *Proceedings of the Eighteenth Annual ACM-SIAM Symposium on Discrete Algorithms*, Society for Industrial and Applied Mathematics, New Orleans, LA, Jan. 7–9, pp. 1027–1035.
- [73] Marler, R. T., and Arora, J. S., 2004, “Survey of Multi-Objective Optimization Methods for Engineering,” *Struct. Multidisciplinary Optim.*, **26**(6), pp. 369–395.
- [74] Fonseca, C. M., and Fleming, P. J., 1993, “Genetic Algorithms for Multiobjective Optimization: Formulation Discussion and Generalization,” *ICGA*, Vol. 93, pp. 416–423.
- [75] Kalyanmoy, D., 2001, *Multi Objective Optimization Using Evolutionary Algorithms*, John Wiley and Sons, Chichester, UK.
- [76] Das, I., and Dennis, J. E., 1997, “A Closer Look At Drawbacks of Minimizing Weighted Sums of Objectives for Pareto Set Generation in Multicriteria Optimization Problems,” *Struct. Optim.*, **14**(1), pp. 63–69.
- [77] Brière, D., Favre, C., and Traverse, P., 1995, “A Family of Fault-Tolerant Systems: Electrical Flight Controls, From Airbus A320/330/340 to Future Military Transport Aircraft,” *Microprocess. Microsyst.*, **19**(2), pp. 75–82.
- [78] Bauer, C., Lagadec, K., Bes, C., and Mongeau, M., 2007, “Flight Control System Architecture Optimization for Fly-by-Wire Airliners,” *J. Guidance, Control, Dyn.*, **30**(4), pp. 1023–1029.