

BY ZONGXUAN SUN
ASSOCIATE PROFESSOR
DEPARTMENT OF MECHANICAL ENGINEERING
UNIVERSITY OF MINNESOTA

HUSSEIN DOURRA
SR. TECHNICAL FELLOW – POWERTRAIN,
SR. MANAGER –PT CONTROLS SCIENCES
FIAT CHRYSLER AUTOMOBILES

Model- Based

Transmission Control

The transmission is an integral part of the automotive powertrain and connects the engine to the vehicle via the driveline. Just as for the internal combustion engine, traditional transmission control has been conducted with extensive calibrations. This is mainly due to the lack of precise models and low cost sensors that can enable real-time model-based feedback control. However the calibration based approach is facing more challenges as the recent trend in transmission systems has driven up the time and cost associated with the calibration process [1-2]. There are two new changes in the transmission system aimed at improving vehicle fuel efficiency and reducing emissions. One is the introduction of different types of transmissions to North America which is traditionally dominated by automatic transmissions. The other is the increasing number of gear ratios for transmissions. Four speed transmissions have

dominated the market for many years until the introduction of five and six speed transmissions a few years ago. Recently eight and nine speed transmissions have been introduced. The increasing number of different types of transmissions and the gear ratios can drastically increase the burden for control calibration. This calls for control-oriented model development and model-based control.

In theory, transmissions are not needed if the engine can provide the required speed and torque for the vehicle in real-time with high efficiency. Unfortunately the engine operation range is not a direct match with the vehicle operation and its efficiency varies significantly as a function of the speed and torque. In order to transfer the engine torque to the vehicle with the desired ratio smoothly and efficiently, various transmissions are designed [3]. The most common automotive transmissions are manual transmission (MT) and step gear automatic transmission (AT). Other types of transmissions include automated manual transmission (AMT), dual clutch transmission (DCT), continuously variable transmission (CVT), and hybrid transmission.

Manual transmissions are controlled by the driver and don't require automatic control. Automatic transmissions conduct gear shift auto-

FIGURE 1 Schematic of the torque based transmission control.

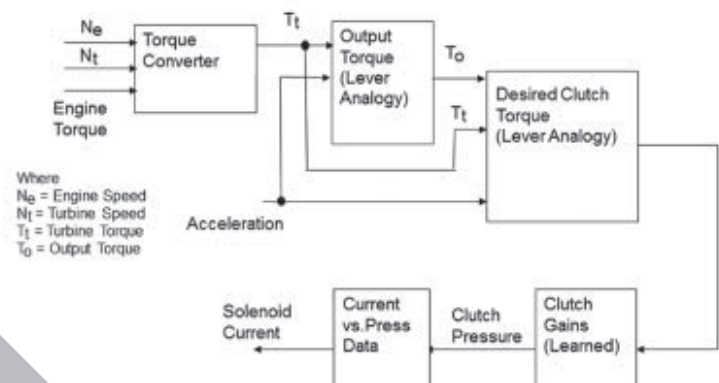

matically and require complex controls [3]. The control problem becomes more challenging as more speeds (gear ratios) are used in automatic transmissions in recent years. The gear shift in AT is realized by shifting a set of clutches actuated with fluid power. So the dynamics of the fluid power actuation system and the clutches are critical to shift quality.

The automated manual transmission design is based on the MT architecture. Actuators are added to select the gears and engage or disengage the clutch that connects the transmission

to the engine. Such automation greatly reduces the complexity of operating the MT but still maintains its high efficiency. However, just as with the MT, torque interruption exists during the AMT gear shift when the clutch has to disengage to disconnect the engine and the transmission. To reduce or eliminate the torque interruption, dual clutch transmissions (DCT) were introduced. DCT uses two input clutches: one for odd gears and one for even gears. DCTs can transmit torque continuously during the shift by coordinating the two input clutches. AMTs, and most DCTs, don't use the torque converter between the engine and the transmission and therefore clutch control is critical to ensure driveline vibration is not triggered.

Continuously variable transmissions (CVT) [4] allow the engine to operate at speed and load conditions independently from the speed and load requests of the vehicle by varying the transmission ratio continuously. This feature enables

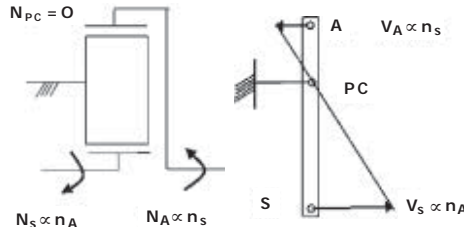

FIGURE 2 Schematic of the lever diagram.

the engine to operate in the optimal region independent of the vehicle speed to maximize the fuel efficiency and reduce emissions. Hybrid transmissions [5-6] are designed to combine engine power and alternative power (electrical or fluid power) for hybrid vehicles. A key architecture for hybrid transmissions is the power split hybrid. Examples include the

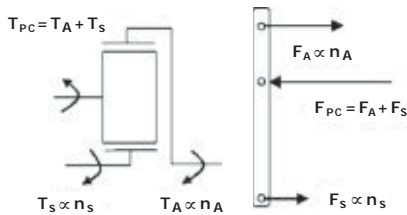

FIGURE 3 Schematic of the lever diagram.

electrically variable transmission (EVT) [5] and the hydro-mechanical transmission (HMT) [6]. The EVT employs an electric motor and generator with one or two sets of planetary gears and it splits the engine power into the mechanical path and the electrical path and then combines them to propel the vehicle. Such power split will provide an extra degree of freedom for optimizing the engine operating condition independent from the vehicle operation. The HMT operates in a similar fashion.

TRANSMISSION MODELING AND CONTROL

Transmission models often consist of the modeling of the gear ratio mechanics and the modeling of the gear shift mechanism [3]. Transmission models are typically combined with the engine model and the vehicle model to simulate the overall powertrain performance.

For automatic transmissions, different nodes of the planetary gearsets are connected to generate different ratios between the engine and the vehicle. For hybrid transmissions, the speed and torque relationship between the sun gear, the carrier, and the ring gear is critical to realize the power split function and therefore needs to be modeled.

The gear shift mechanisms can be divided into two categories: hydraulically actuated systems and electrically actuated systems. For ATs, hydraulically actuated clutches are used to connect different nodes of

the planetary gearsets. During the gear shift, one clutch (release clutch) will be disengaged, and the other clutch (apply clutch) will be engaged. This is called the clutch-to-clutch shift technology. The coordination of the apply clutch torque and the release clutch torque is critical to the shift quality. So the modeling of the electro-hydraulic actuation system and the clutch dynamics is needed [1, 7-8].

For hybrid transmissions, besides the gear ratio mechanics and the gear shift mechanism, the alternative power source also needs to be modeled, such as the motor, generator and the battery [3]. The control-oriented models can be used for a control design purpose and for real-time simulation.

Transmission control is mainly concerned with the transmission shift scheduling and gear ratio shift control. The shift scheduling [9] determines when to shift and to which gear (the new gear ratio). This is necessary since all transmissions except MT will determine the gear ratio automatically in real-time.

Traditionally the shift scheduling is designed based on the throttle position and the vehicle speed. More factors are being considered to better coordinate the transmission ratio with the engine operation to improve fuel economy and reduce emissions. The transmission gear ratio shift control is targeted to achieve a smooth shift from the current gear to the new gear ratio based on the shift scheduling. For CVTs, it is shifted from one ratio to another rather than a discrete step gear ratio. The gear ratio shift depends heavily on the specific shift mechanism of the transmissions. For ATs and CVTs, and many AMTs and DCTs, such shift mechanism is conducted with a fluid power system [11]. The controlling of the fluid power system (pressure, flow) and the clutch is critical to realize good shift quality. For ATs, the control is achieved by a combination of open loop, closed loop and event based controls. Part of the challenge for realizing complete

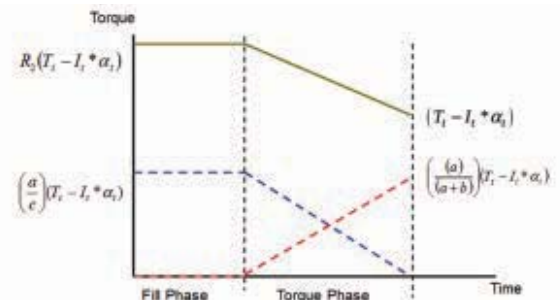

FIGURE 4 Diagram for clutch to clutch shift where R_2 is ratio, I_t is turbine inertia, T_t is turbine torque, α_t is turbine acceleration, a, b, c are lever constants.

feedback control is the availability of low cost and reliable sensors.

Traditionally, calibration has been the key method for designing and tuning the transmission control. This method becomes more time consuming today due to the increasing number of transmission speeds and the high number of various types of transmissions. Model-based transmission control is necessary to further improve system performance and reduce the development time. To achieve this objective, research work on hardware (sensors and actuators), control-oriented model development and advanced control methodologies is required. Several examples include a feedback loop in the transmission hydraulic control module and pressure based clutch feedback control.

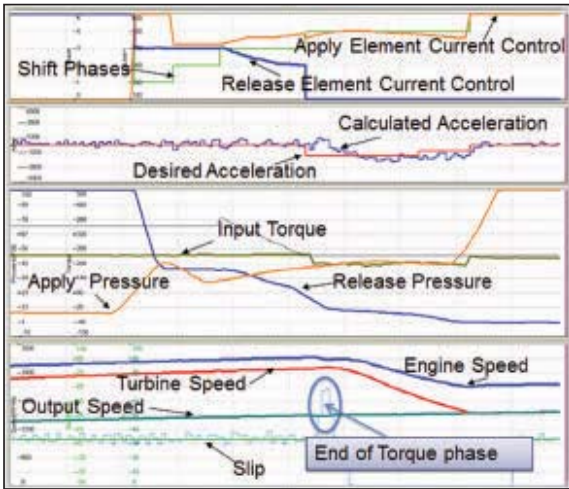

FIGURE 5 Experimental results of clutch-to-clutch shift in a vehicle.

Hybrid transmission control is further integrated with the engine control. To operate the power split hybrid transmission, coordination among engine, motor and generator operation is necessary [12]. The hybrid control consists of mainly two levels. The high level determines the energy distribution between the engine and the alternative power source so that the overall fuel efficiency is achieved. The lower level controls the actuators (engine, motor, generator) to achieve the desired operating points determined by the high level control. Again model-based control and optimization are needed to reduce the development time and improve system performance and efficiency.

Given space restrictions, in the next section, we will use the automatic transmission as an example to illustrate the modeling and control of transmissions.

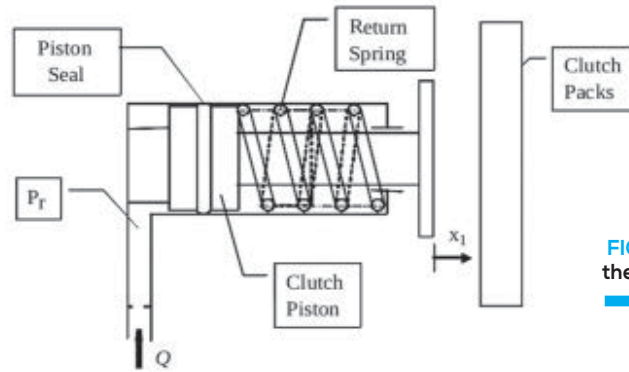

FIGURE 6 Schematic of the transmission clutch.

AUTOMATIC TRANSMISSION MODELING AND CONTROL

Automatic transmissions consist of the torque converter, the planetary gearsets and the clutch actuation system [3]. Different gear ratios are realized by connecting different nodes of the planetary gearsets. Tools that describe the planetary gearset kinematic architecture arrangements offer opportunities for control engineers to develop physics and model based strategies. The Lever Analogy has been proven to be a good tool for such analysis. The entire transmission can be represented by a single or multiple vertical lever(s). The input, output, and reaction torques are represented by horizontal forces on the lever, and the lever motion, relative to the reaction point, represents rotational velocities. **Figure 1** describes a torque based approach using the Lever Analogy.

The procedure for setting up a lever system analogous to a transmission is: 1) Replace each gearset by a vertical lever; 2) Rescale, interconnect, and/or combine levers according to the gearsets' interconnections.

If the carrier of a simple gearset is grounded as shown in **Figure 2**, the annulus and the sun will rotate in opposite directions at relative speeds inversely proportional to their numbers of teeth. As shown in **Figures 2** and **3**, the horizontal velocity and force relationships of the lever are identical to the rotational velocity and torque relationships of the gearset.

Using the above procedure, clutch torque can be calculated as a function of input torque, inertias, lever constants and desired output torque. As shown in **Figure 4**, the top signal is the output torque, the bottom signals are the release clutch torque (blue) and the apply clutch torque (red).

This approach was implemented in a vehicle, and results are shown in **Figure 5**. The current control signals sent to the apply clutch and release clutch are shown in the first row. The clutch pressures are shown in the third row. As a result of the synchronized torque capacity transfer between the apply clutch and the release clutch during the torque phase, the actual acceleration is able to follow the desired acceleration without significant vibration as shown in the second row. The engine speed and turbine speed move to the new set points during the inertia phase as shown in the last row.

As discussed above, the clutch is the actuator that facilitates the gear shift. Therefore the modeling and control of the clutch is critical for the clutch-to-clutch shift technology.

As shown in **Figure 6**, the dynamics of an electro-hydraulically actuated clutch can be modeled as [8]:

$$\begin{aligned} \dot{x}_1 &= x_2 \\ \dot{x}_2 &= \frac{1}{M_p} \times [A_p \times (P_r + P_c - P_{ann}) - D_p x_2 \\ &\quad - F_{avg}(P_r + P_c, x_2) - F_{res}(x_1 + x_{p0})] \\ \dot{P}_r &= \frac{\beta(P_r)}{V} [Q(u, P_r) - A_p x_2] \end{aligned} \quad (1)$$

where x_1 is the clutch piston displacement, x_2 is the clutch piston velocity, M_p is the effective mass of the piston, A_p is the piston surface area, and D_p is the clutch damping coefficient. P_r is the clutch chamber pressure. P_c is the centrifugal force

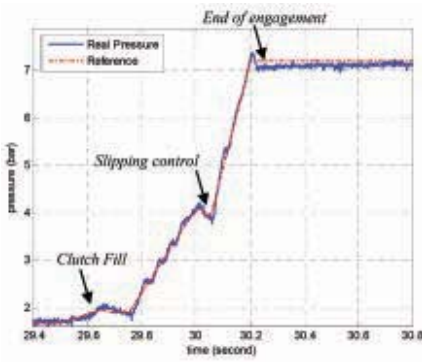

FIGURE 7 Pressure tracking performance during clutch fill and clutch engagement.

and it is often controlled with a solenoid valve.

This model contains several nonlinearities. The drag force is dependent on the clutch motion as well as the clutch chamber pressure that expands the piston seal against the wall. The fluid bulk modulus is a function of the chamber pressure, especially at the low pressure range and with high air entrapment. The clutch resistance force during the clutch engagement is typically a nonlinear function of the clutch displacement and can also vary as a function of temperature. Those nonlinear dynamics are difficult to model precisely and require robust control to enable precise and robust performance.

One way to control the clutch is to embed a pressure sensor in the clutch chamber and close the loop with a sliding mode control due to its ability to handle nonlinear dynamics and system uncertainty [8]. The idea is to control the incoming flow to the clutch chamber through a solenoid valve so that the chamber pressure will track a desired pressure profile. The pressure based control will ensure a precise clutch fill as well as the clutch engagement.

Define the tracking error e_2 as the difference between the desired pressure trajectory r and the actual measurement P_r .

$$e_2 = P_r - r \quad (2)$$

And define another error term e_1 , the derivative of which is equal to e_2 .

$$\dot{e}_1 = e_2 \quad (3)$$

With the pressure dynamics in (1), we have

$$\begin{aligned} \dot{e}_2 &= \dot{P}_r - \dot{r} \\ &= \frac{\beta(P_r)}{V} [Q(u, P_r) + \Delta_2(u, P_r) - A_p x_2] + \Delta_1(P_r) - \dot{r} \\ &= \frac{\beta(P_r)}{V} Q(u, P_r) - \frac{\beta(P_r)}{V} A_p x_2 - \dot{r} + \Delta_1(P_r) + \frac{\beta(P_r)}{V} \Delta_2(u, P_r) \end{aligned} \quad (4)$$

where $\Delta_1(P_r)$ represents the model uncertainty of the pressure dynamics, and $\Delta_2(u, P_r)$ represents the model uncertainty of the control valve dynamics. Bounds of the uncertainty terms can be obtained experimentally.

Define the sliding surface S as:

$$S = k_1 e_1 + e_2 \quad (5)$$

where k_1 is a weighting parameter. Then the controller can be designed as:

$$u = -U \left\{ \frac{V}{\beta(P_r)} \times [k_1 e_2 - \frac{\beta(P_r) A_p}{V} \times \hat{x}_2 - \dot{r}] + \gamma(P_r, \hat{x}_2) \text{sign}(S), P_r \right\} \quad (6)$$

where U is the mapping from the flow rate to the control voltage of the solenoid valve \hat{x}_2 is the estimate of x_2 , and $\gamma(P_r, \hat{x}_2)$ is the controller gain. Experimental implementation of the sliding mode control [8] has achieved precise pressure tracking as shown in **Figure 7**. The precise clutch fill ensures the clutch packs are ready to be engaged and the clutch chamber pressure is then raised during the torque phase until the clutch is fully engaged.

CONCLUSION

This paper reviews different types of automotive transmissions and presents the challenges of transmission modeling and control. It uses an automatic transmission as an example to illustrate the control-oriented model development and model based control. ■

REFERENCES

- 1 Z. Sun and K. Hebbale, "Challenges and Opportunities in Automotive Transmission Control", *Proceedings of the 2005 American Control Conference*, Portland, OR, pp. 3284-3289, June, 2005.
- 2 G. Wagner, "Application of Transmission Systems for Different Driveline Configurations in Passenger Cars", SAE Technical Paper 2001-01-0882.
- 3 Z. Sun and G. Zhu, *Design and Control of Automotive Propulsion Systems*, CRC press, 2015.
- 4 M. Kluger and D. Fussner, "An Overview of Current CVT Mechanisms, Forces and Efficiencies", SAE Technical Paper 970688.
- 5 J. Meisel, "An Analytical Foundation for the Toyota Prius THS-II Powertrain with a Comparison to a Strong Parallel Hybrid-Electric Powertrain", SAE Technical Paper 2006-01-0666.
- 6 J. Van de Ven, M. W. Olson, and P. Y. Li, "Development of a hydro-mechanical hydraulic hybrid drive train with independent wheel torque control for an urban passenger vehicle", IFPE 2008, Las Vegas, NV, 2008.
- 7 X. Song, A. Mohd Zulkefli, Z. Sun, and H. Miao, "Automotive Transmission Clutch Fill Control Using a Customized Dynamic Programming Method", *ASME Journal of Dynamic Systems, Measurement, and Control*, Vol. 133, 054503, September, 2011.
- 8 X. Song and Z. Sun, "Pressure Based Clutch Control for Automotive Transmissions Using a Sliding Mode Controller", *IEEE/ASME Transactions on Mechatronics*, Vol. 17, No. 3, pp. 534-546, June, 2012.
- 9 G. Qin, A. Ge, and J. Lee, "Knowledge-Based Gear-Position Decision," *IEEE Transactions on Intelligent Transportation Systems*, Vol. 5, No. 2, June 2004.
- 10 M. Kawai, H. Aruga, K. Iwatsuki, T. Ota, and T. Hamada, "Development of Shift Control System for Automatic Transmission Using Information From a Vehicle Navigation System", SAE Technical Paper 1999-01-1095.
- 11 X. Song, Z. Sun, X. Yang, and G. Zhu, "Modeling, Control, and Hardware-in-the-Loop Simulation of an Automated Manual Transmission", *Proceedings of the IMechE, Part D, Journal of Automobile Engineering*, Vol. 224, No. 2, pp.143-160, 2010.
- 12 Y. Wang, and Z. Sun, "Dynamic Analysis and Multivariable Transient Control of the Power-Split Hybrid Powertrain", *IEEE/ASME Transactions on Mechatronics*, DOI 10.1109/TMECH.2015.2403319, 2015.