

## Wavelet-based multi station disaggregation of rainfall time series in mountainous regions

Nima Farboudfam, Vahid Nourani and Babak Aminnejad

### ABSTRACT

Hybrid models development by combining the data-driven method of artificial neural network (ANN) and wavelet decomposition for disaggregation of rainfall time series is the purpose of this paper. In this study, for disaggregating the Tabriz and Sahand rain-gauges time series, according to nonlinear characteristics of observed time scales, a wavelet-artificial neural network (WANN) hybrid model was suggested. For this purpose, 17 years of daily data of four rain-gauges and monthly data of six rain-gauges from the mountainous basin of Urmia Lake were decomposed with wavelet transform and then using mutual information and correlation coefficient criteria, the sub-series were ranked and superior sub-series were used as input data of ANN model for disaggregating the monthly rainfall time series to the daily time series. Results obtained by the WANN disaggregation model were compared with the results of ANN and classic multiple linear regression (MLR) models. The efficiency of the WANN model compared with the ANN and MLR models at validation stage in the optimized case for Tabriz rain-gauge showed up to a 22 and 41.2% increase and in the optimized case for Sahand rain-gauge it showed up to a 21.1 and 40.8% increase, respectively.

**Key words** | artificial neural network, disaggregation, hybrid model, rainfall time series, Urmia Lake basin, wavelet transform

**Nima Farboudfam**  
**Vahid Nourani** (corresponding author)  
**Babak Aminnejad**  
Department of Civil Engineering, Roudehen Branch,  
Islamic Azad University,  
Roudehen,  
Iran  
E-mail: [nourani@tabrizu.ac.ir](mailto:nourani@tabrizu.ac.ir)

**Vahid Nourani**  
Faculty of Civil Engineering,  
University of Tabriz,  
29 Bahman Ave., Tabriz 5166616471,  
Iran  
and  
Faculty of Civil Engineering,  
Near East University,  
P.O. Box: 99138, Nicosia, North Cyprus, Mersin 10,  
Turkey

### INTRODUCTION

The reliable prediction of rainfall at different time and space scales can provide necessary information for the design of civil projects, land use, city planning and water resources management. Also, it performs a main role in reducing the effects of drought on water resources systems. Therefore, in recent years many attempts have been made to develop theoretical methods for rainfall modeling as an important component of the hydrologic cycle. The limited availability of data at suitably small temporal and/or spatial resolution may be a typical drawback in hydrological studies. Rainfall disaggregation has emerged as an important tool for facing this problem.

Disaggregation techniques have the potential to extend the time or spatial resolution of certain processes, such as rainfall, whereas at the same time preparing a multiple scale protection of the stochastic structure of the hydrologic

processes. This definition of disaggregation identifies it from downscaling, which aims at producing finer data with the specified statistics but which do not essentially add up to the observed original data (Koutsoyiannis 2002). Both disaggregation and downscaling refer to transferring information from a given scale (higher-level) to a smaller scale (lower-level), e.g. they generate consistent rainfall time series at a specific scale given a known precipitation measured or simulated at a certain coarser scale. The two approaches are very similar in nature but not identical to each other. Downscaling aims at producing the finer-scale rain field with the required statistics being statistically consistent with the given field at the coarser scale, while disaggregation has the additional requirement to produce a finer-scale rain field that adds up to the given coarse-scale total (Lombardo *et al.* 2012). According to recent studies, generally

downscaling methods are focused on large-scale historical atmospheric variables like general circulation models (GCMs), but disaggregation methods are typically applied to the observational data for temporal or spatial disaggregation.

Time series are generally disaggregated or downscaled in two principal ways. The first one is the ‘dynamical method’, which explicitly includes additional data and physical processes in models (such as GCMs), but at a much higher resolution, and covers only the selected portions of the globe. This method has numerous advantages but is computationally intensive and requires large volumes of data as well as a high level of expertise to implement and interpret results, often beyond the capacities of institutions in developing countries. The second one is the ‘statistical method’, which establishes a statistical relationship using simple regression, multivariate regression, neural network, etc., between inputs and output(s). In contrast to the dynamical method, the statistical methods are easy to implement and interpret. They require minimal computing resources but rely heavily on historical climate observations and the assumption that currently observed relationships will carry into the future (Trzaska & Schnarr 2014). For cases in which there is a natural interpretation of ‘between’, such as where the prediction is about time or space, interpolation involves making a prediction between cases for which there are data. Extrapolation involves making a prediction that goes beyond the observed examples. Extrapolation is usually much more inaccurate than interpolation. For example, it is often easy to predict rainfall on a certain day given data about the rainfall on the days before and the days after that day. It is very difficult to predict what the rainfall will be tomorrow, and it would be very profitable to be able to do so. An agent must be careful if its test cases mostly involve interpolating between data points, but the learned model is used for extrapolation. As a result, one of the limitations of black-box models is that they cannot be used for extrapolation of the data beyond the observed data (Poole & Mackworth 2017).

For complex systems, disaggregation using a black-box (empirical) model can be a reliable choice. Different black-box (statistical) techniques have been advanced and implemented by researchers for temporal disaggregation of different hydro-climatological parameters (e.g. Nagesh

Kumar *et al.* 2000; Sivakumar *et al.* 2001; Socolofsky *et al.* 2001; Gyasi-Agyei 2005; Chen 2007; Choi *et al.* 2008; Zhang *et al.* 2008; Knoesen & Smithers 2009; Brown 2012).

The stochastic modeling method is on the basis of probability density function (PDF), where the PDF expresses the probability of a continuous random variable taking on a value between any two points in the range of that variable. Different linear stochastic disaggregation problems in hydrological applications have been introduced by researchers (e.g. Woolhiser & Osborn 1985; Hershendorff & Woolhiser 1987; Koutsoyiannis 1988; Econopoulou *et al.* 1990; Koutsoyiannis & Xanthopoulos 1990; Garcia-Guzman & Aranda-Oliver 1993; Koutsoyiannis & Pachakis 1996; Zarris *et al.* 1998). Such linear stochastic modeling schemes have been used, among other applications, for univariate or multivariate disaggregation of annual to monthly rainfall. However, modeling schemes of this kind are not suitable for the disaggregation of rainfall for timescales finer than monthly, due to the skewed distributions and the intermittent nature of the rainfall process at fine timescales (Koutsoyiannis *et al.* 2003).

Stationarity is usually a desirable assumption in the analysis of rainfall time series (Koutsoyiannis & Montanari 2015). In fact, there is a well-defined mathematical definition of stationarity, which imposes certain regular conditions on either a distribution or its moments and various methods are developed to determine the stationary relation governing the time series data. Artificial neural network (ANN)-based models are being used more frequently in the analysis of rainfall time series, as they move from simple pattern recognition to a diverse range of application areas. It is known that the ANN mapping process can cover a greater range of problem complexity and is superior in its generality and practical ease in implementation due to its powerful and flexible capability (Kim *et al.* 2004). Kim *et al.* (2004) investigated the ANN’s capability of extracting a rule governing seemingly non-stationary time series data. Indeed, they investigated the range of complexity due to non-stationarity that ANN might cover and found that overfitting by an ANN may be useful for such complex time series analysis. The results showed that overfitting by ANN could play a significant role in the analysis of non-stationary time series. Thus, when working with complex and non-linear phenomena having non-stationary data, artificial intelligence (AI)

based models as a new descendant of non-linear black-box models may be employed to manage the modeling deficiencies. Natural uncertainty and nonlinearity of stochastic processes such as rainfall, the demand for fine-scale and long-term spatiotemporal recordings, and the complexity of physically based techniques are the reasons why researchers have tried to extend AI-based black box models. ANN, as this type of AI-based model, has the potential to identify and recognize patterns and relationships involved within the given dataset by consideration of large degrees of dynamicity, and non-linearity of noisy data.

During the past decades, different ANN-based models have been extended and applied for rainfall time series temporal disaggregation. Burian *et al.* (2000), for disaggregation of hourly rainfall data into sub-hourly time increments, evaluated the utilization of ANNs. Burian *et al.* (2001) investigated the performance of various ANN models and training problems in rainfall disaggregation. The results showed that records from rain-gauge stations among many hundred kilometers around the desired station may be enough for training the ANN-based disaggregation of rainfall time series. Burian & Durrans (2002) examined how the errors within the disaggregated rainfall hyetographs will result in the errors within the predicted runoff hydrographs. Kim & Singh (2015) extended ANN models, including Kohonen self-organizing feature map (KSOFM) and multilayer perceptron (MLP), for spatial disaggregation of areal rainfall in the Wi-stream basin.

Regardless of the ANN flexibility for modeling and simulation of non-linear climatological processes, some deficiencies may arise in the disaggregation process because of the seasonal variations and non-stationarity of the signal, which may vary from 1 hour to many decades. This model can additionally generate deceptive assessments if seasonality selection, particular noise reduction, and features are not cautiously considered. So, space and/or time data pre-processing in such circumstances may be a reliable method to vanquish such weaknesses. Due to the self-similar and multi-resolution patterns which usually are involved in the precipitation process, on the one hand, and the potency of wavelet transform for multi-scale analysis of signals, on the other, the wavelet concept can be utilized as a data pre-processing technique in the rainfall disaggregation content.

A few studies can be found in the technical literature regarding the use of wavelet for disaggregation of rainfall time series. For example, Rashid *et al.* (2015) evaluated the utilization of wavelet transform for decomposing the original rainfall data and used the semi-parametric formulation of Generalized Additive Model for Location, Scale, and Shape (GAMLSS) for rainfall time series downscaling. Kim *et al.* (2016) developed hybrid models by merging data-driven models containing generalized regression neural networks (GRNN), support vector machines (SVM), and wavelet decomposition for disaggregation and aggregation of rainfall time series.

Disaggregation of a monthly (or larger) scale rainfall time series to the daily is a challenge for many hydro-climatologists (e.g. Koutsoyiannis & Manetas 1996; Guenni & Bardossy 2002; Hansen & Ines 2005; Dhekale *et al.* 2017) and so, in this paper, as a novel disaggregation method, the wavelet analysis is connected to the ANN to disaggregate the monthly observed rainfall time series to the daily sub-series in a multi-station form. The performance of the proposed technique is evaluated for a mountainous region in the northwest of Iran. The results are also compared with the results of a well-known classic rainfall disaggregation model of multiple linear regression (MLR) (Partovian *et al.* 2016). The main difference between the current study and the aforementioned two recent wavelet-based studies is that Rashid *et al.* (2015) developed GAMLSS downscaling (not disaggregation) models based on output data of GCM datasets, whereas in this research, spatio-temporal disaggregation models are extended according to the field data, measured at different rain-gauges. Furthermore, Kim *et al.* (2016) used WSVM and WGRNN models only for spatial (not temporal) disaggregation of rainfall values, while the developed wavelet-artificial neural network (WANN) model in this research is used for multi-station spatiotemporal disaggregation of the rainfall time series.

## MATERIALS AND METHODS

### Study area and data

Urmia Lake basin, with an area of 51,876 km<sup>2</sup>, is located in the northwest of Iran. The Urmia Lake basin is a mountainous zone including two of the famous Iranian volcanic

peaks (Sabalan, 4,810 m and Sahand, 3,707 m), with numerous wide plains in the valleys and around the lake. Because of numerous tectonic events during different geological eras, the geology of the basin is rather complex. The methodology proposed in this paper has been applied to the Urmia Lake basin, particularly to the catchment of its primary tributaries located in East Azerbaijan province of Iran. Average annual rainfall in the basin varies from 200 to 690 mm, averaging 345 mm. This basin is one of the main important ecosystems in the country. The catchment is equipped with several rain-gauges, of which only six with complete recorded data were used in this study; Tabriz, Sahand, Sarab, Maragheh, Bonab, and Ahar (Figure 1). The available dataset was for 17 years of daily recorded series coming from all rain-gauges mentioned, covering the period from January 2000 to October 2016. The disaggregation was performed using daily data only from four rain-gauges (Sarab, Maragheh, Bonab, and Ahar) and monthly data from all rain-gauges.

The Urmia Lake basin position and topography, and also rainfall time series' statistical characteristics on the daily scale of the stations, are presented in Figure 1 and Table 1, respectively.

According to Table 1, the maximum and minimum average rainfalls were measured at Ahar and Sahand stations, respectively, and data of Bonab and Sahand stations show maximum and minimum standard deviation (SD) values, respectively.

In the ANN modeling, the time series should be divided into calibration and validation categories. The partition can be about 25% for the validation and about 75% for calibration. Furthermore, normalization of the data to increase the accuracy of time series prediction and improve results has a significant impact (Nourani et al. 2009). By normalizing the target and input data before training, the model training development may be speeded up (Rogers 1996). In this research, the input and target data were normalized between 0 and 1 as:

$$Q_i = \frac{a_i - a_{\min}}{a_{\max} - a_{\min}} \quad (1)$$

In Equation (1),  $a_{\max}$ ,  $a_{\min}$  and  $a_i$  are the maximum, the minimum and the desired variable values, respectively, and  $Q_i$  is the normalized variable.

Two factors are very significant and more consideration should be given to them in ANN modeling; first, training iteration number (epoch), and second, the ANN architecture. The appropriate choice of these two factors may improve the model performance in each phase of training and validation and prevent the over training of the ANN model.

### Proposed methodology

In this study ANN (as the commonly used AI tool) and wavelet transform were linked for multi-station rainfall disaggregation. For this purpose, large-scale input data for a few stations were prepared and after normalization of data, in two cases with and without wavelet transform, were disaggregated into finer-scale time series. In the first case, the main raw data were used as inputs of the ANN model for disaggregating the monthly rainfall time series to the daily time series, and in the second case, the time series were decomposed into sub-series at different scales with the wavelet transform at level  $X$ , then the sub-series were ranked using mutual information (MI) and correlation coefficient (CC) criteria (Swinscow & Campbell 1997), and then the selected sub-series were used as input data of the ANN model for disaggregating the monthly rainfall time series to the daily time series. Results obtained by the WANN disaggregation model were also compared with the results of ANN and classic MLR models.

The schematic procedure of the rainfall disaggregation with the WANN hybrid model is shown in Figure 2.

The disaggregation procedure with the WANN model was performed using daily data of four rain-gauges (Sarab, Maragheh, Bonab, and Ahar) and monthly data from all rain-gauges. These input data were decomposed with Coif1, Db2, Haar, and Sym3 mother wavelets, and then the decomposed sub-series were ranked by CC and MI criteria and the selected dominant sub-series used as inputs of the ANN model to compute the daily time series of Tabriz and Sahand rain-gauges as disaggregation procedure. Components of the methodology are briefly described as follows.

### Wavelet transform

Recently, the extended form of Fourier transform as the wavelet transform has grown in popularity and usage since

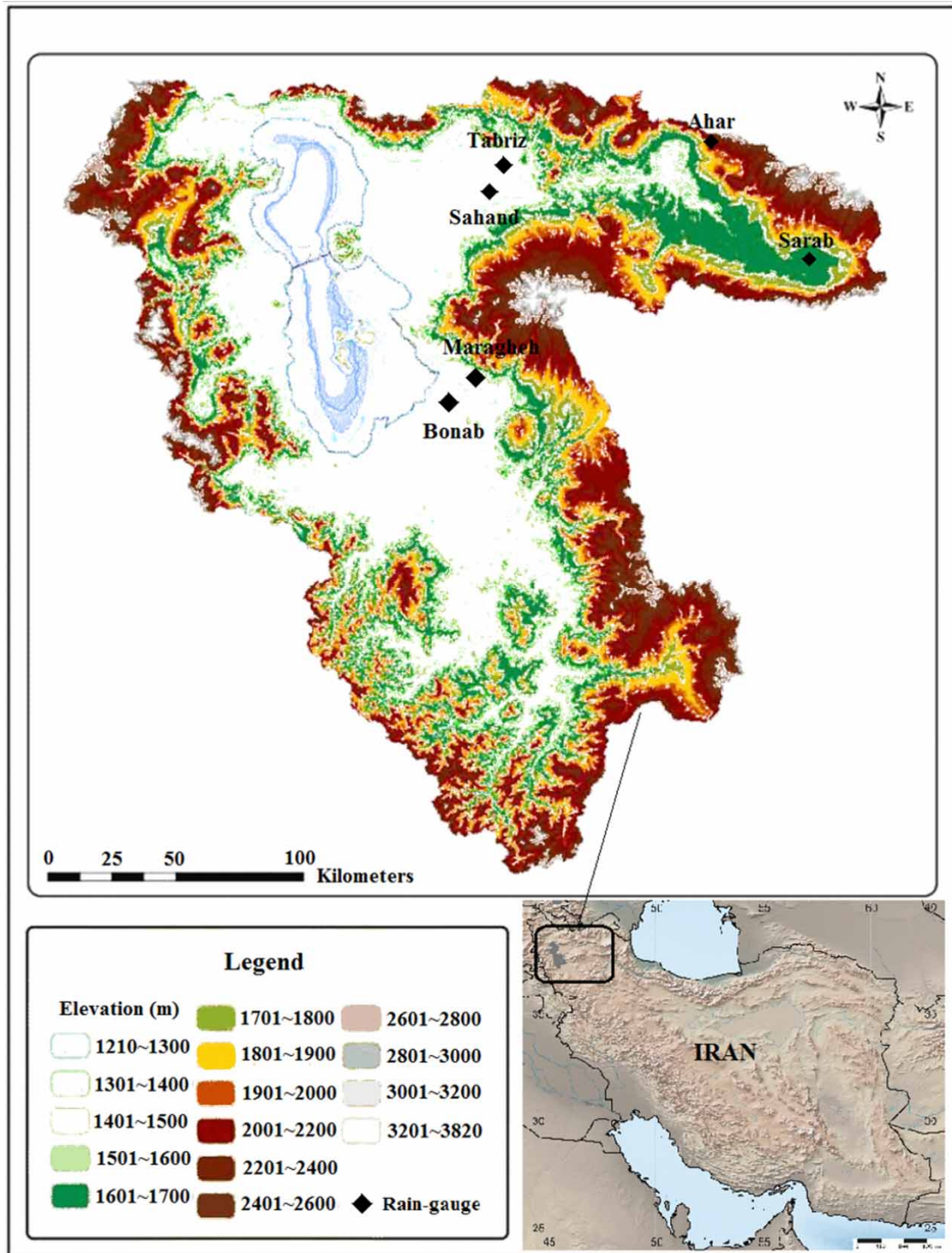
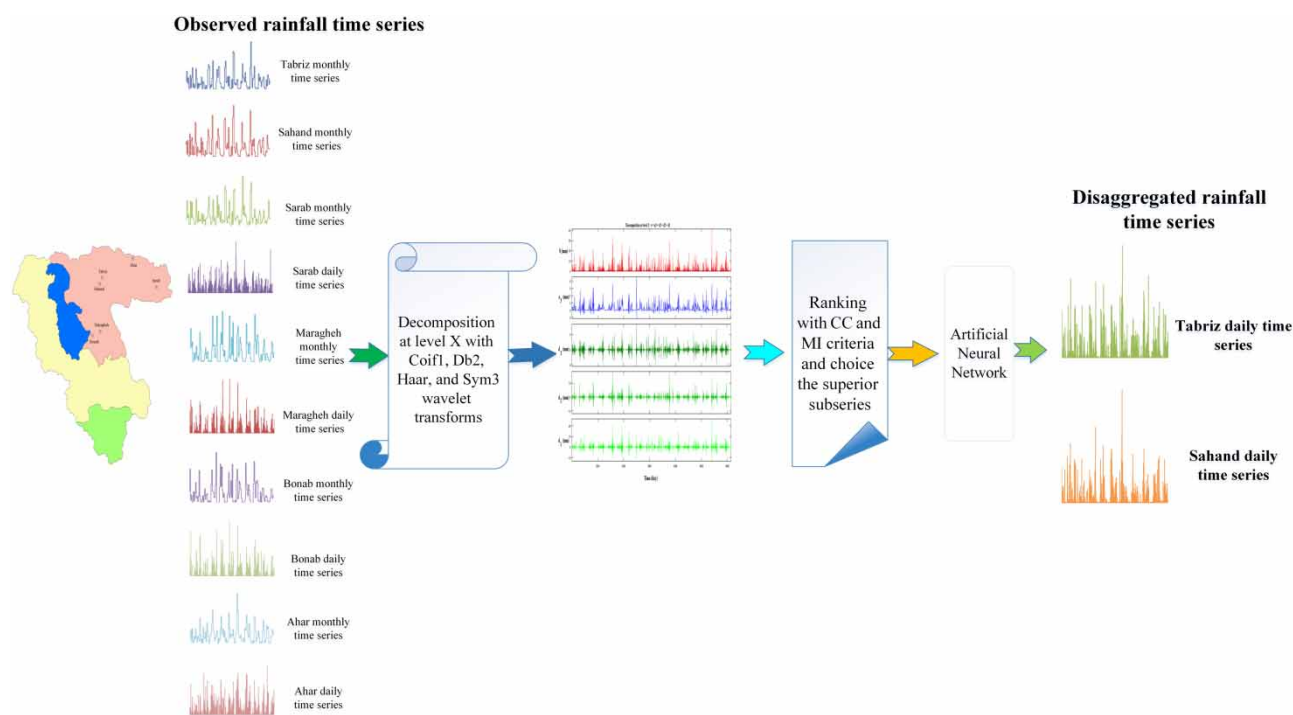

Figure 1 | Urmia Lake basin and rain-gauges.

**Table 1** | Statistics of daily rainfall time series at study stations

Description	Period	Unit	Stations					
			Tabriz	Sahand	Sarab	Maragheh	Bonab	Ahar
Number of data	Calibration	–	4,612	4,612	4,612	4,612	4,612	4,612
	Verification		1,537	1,537	1,537	1,537	1,537	1,537
Mean	Calibration	mm	0.647	0.551	0.682	0.683	0.710	0.735
	Verification		0.757	0.610	0.596	0.695	0.751	0.803
Maximum value	Calibration	mm	27.8	33.6	30.6	66.20	45	34.9
	Verification		46.4	41.1	21.3	31.9	40	46.7
Standard deviation	Calibration	mm	2.326	2.108	2.301	2.726	2.779	2.548
	Verification		2.691	2.264	2.016	2.594	2.816	2.889
Skewness	Calibration	–	5.796	6.591	5.527	8.059	6.529	5.777
	Verification		6.808	7.337	5.595	5.934	6.200	6.738

**Figure 2** | Procedure of rainfall disaggregation with WANN hybrid model.

its beginning in the early 1980s. Fourier analysis has a considerable disadvantage in dealing with discontinuous or multi-scale functions: from a numerical standpoint, issues of convergence play a massive role. This leads to a secondary issue, that Fourier series are not efficient at resolving discontinuous or multi-scale functions. Related to the above fact is that Fourier series give no information on the

spatial/temporal localization of features. A Fourier series or transform can tell you that there is a discontinuity, but it cannot tell you where it is; whereas wavelet analysis, despite having irregular shape, is able to exactly reconstruct functions with linear and higher order polynomial shapes, such as triangle, rectangle, second order polynomials, etc. As a result, wavelets are able to de-noise the specific signals

far better than the common filters that are based on Fourier transform (Grossmann & Morlet 1984). A detailed work study of wavelet has been reported by Foufoula-Georgiou et al. (1995) and the latest contributions have been cited by Labat (2005).

The time-scale wavelet transform of a continuous time signal,  $x(t)$ , is described as (Mallat 1989):

$$T(y, z) = \frac{1}{\sqrt{y}} \int_{-\infty}^{+\infty} p^* \left( \frac{t-z}{y} \right) x(t) dt \quad (2)$$

where  $z$  is the temporal interpretation of the function  $p(t)$ ,  $y$  is a dilation factor,  $p(t)$  is the wavelet function,  $*$  corresponds to the complex conjugate and  $T(y, z)$  is the wavelet coefficient.

For applied applications, the hydrologist does not have a continuous time series; however, as a substitute, a discrete time series is essential. According to the trapezoidal rule, a discretization of Equation (1) may be the easiest form of the continuous wavelet transform, producing  $M^2$  factors

from a set of  $M$  lengths. Redundant data may not include useful information in the modeling process (Addison et al. 2001). A uniform logarithmic spacing can be applied to conquer this redundancy for a scale discretization with a mutually larger resolution of the  $z$  locations, which allows  $M$  transform coefficients to exactly explain a signal of length  $M$ . Such a discrete mother wavelet has the form of (Mallat 1989):

$$p_{b,a}(t) = \frac{1}{\sqrt{y_0^b}} p \left( \frac{t - az_0 y_0^b}{y_0^b} \right) \quad (3)$$

where  $z_0$  is the location parameter, where  $z_0 > 0$ , with  $z_0$  corresponding to 1,  $y_0$  is the specified fine dilation, where  $y_0 > 1$ , with  $y_0$  usually corresponding to 2, and  $a$  and  $b$  are integer numbers that qualify the wavelet translation and dilation, respectively.

Some mother wavelets, such as *coif1*, *db2*, *Haar*, and *sym3* (Mallat 1989), which are shown in Figure 3, were examined in the proposed modeling.

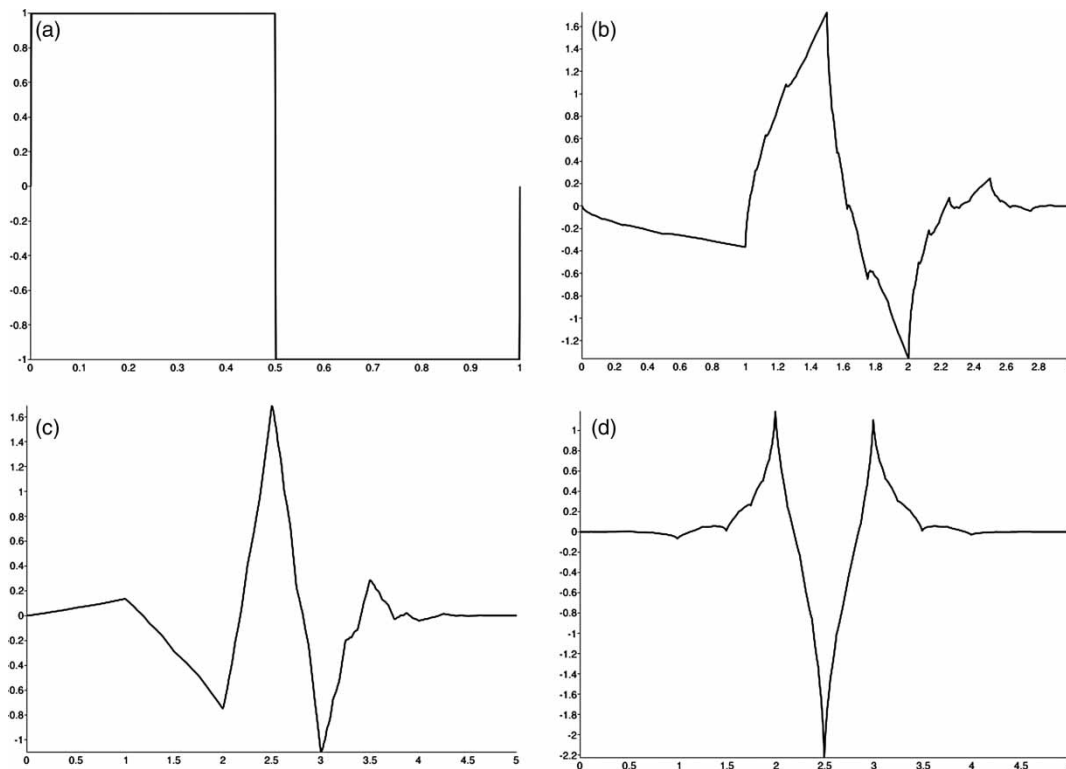

Figure 3 | (a) Haar wavelet, (b) db2 wavelet, (c) sym3 wavelet and (d) coif1 wavelet.

**Artificial neural networks (ANNs)**

ANN is extensively used for time series prediction in the water resource and hydrology fields. In ANN, the feed forward back propagation (BP) network models are a very conventional method for engineers. It has been demonstrated that this model with three layers is satisfactory for simulating and prediction in water related sciences (ASCE 2000). Feed forward neural networks (FFNNs) with three layers, which have been typically utilized in hydrological time series prediction and provide a common framework for demonstrating non-linear functional mapping among a couple of output and input variables, are presented in Figure 4.

In Figure 4,  $w$  is the neuron’s practical weight and  $k, j$  and  $i$  explain output layer, hidden layer and input layer neurons, respectively. The precise expression for the output value of FFNNs is represented by (Kim & Valdés 2003):

$$\hat{b}_k = f_0 \left[ \sum_{j=1}^M v_{kj} \cdot f_h \left( \sum_{i=1}^N v_{ji} a_i + v_{j0} \right) + v_{k0} \right] \tag{4}$$

where  $v$  is the bias for the  $j$ th hidden neuron,  $v_{j0}$  is a weight in the output layer linking the  $j$ th neuron in the hidden layer and the  $k$ th neuron in the output layer,  $v_{ji}$  is a weight in the hidden layer linking the  $i$ th neuron in the input layer and the

$j$ th neuron in the hidden layer,  $f_h$  is the activation function of the hidden neuron,  $v_{k0}$  is bias for the  $k$ th output neuron,  $f_o$  is the activation function for the output neuron,  $a_i$  is the  $i$ th input variable for the input layer and  $\hat{b}_k$  is the computed output variable.  $M$  and  $N$  are the neuron numbers of the hidden and input layers, respectively. The weights amounts may be varied all over the network training process.

**Hybrid wavelet-artificial neural network (WANN) model**

The suggested WANN model contains a feed forward perceptron structure with three layers. The first layer includes a stop ranked rainfall sub-series which is derived from the wavelet transform and ranked by MI and CC criteria as Equations (5) and (6) (Swinscow & Campbell 1997):

$$MI(a, b) = - \int \int p(a, b) \log \frac{p(a, b)}{p(a)p(b)} da db \tag{5}$$

$$CC = \frac{\sum_{i=1}^N (a_i - \bar{a})(b_i - \bar{b})}{\sqrt{\sum_{i=1}^N (a_i - \bar{a})^2 \sum_{i=1}^N (b_i - \bar{b})^2}} \tag{6}$$

where  $p(a, b)$  is the probability of  $a$  and  $b$ ,  $p(b)$  is the probability of  $b$ ,  $p(a)$  is the probability of  $a$ , and  $a, b, \bar{a}$  and  $\bar{b}$  are observed and target sub-series and the mean values of  $a$  and  $b$ , respectively.

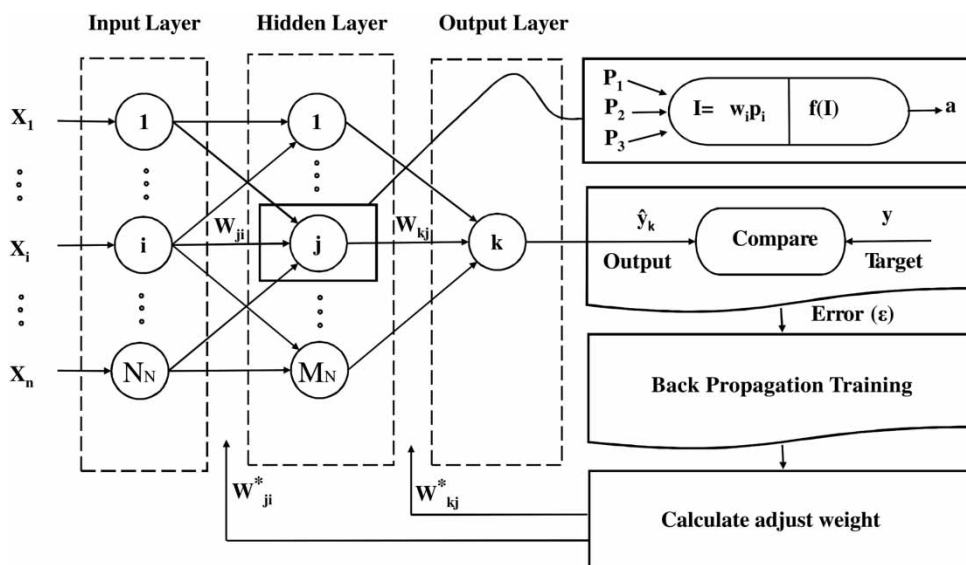

**Figure 4** | A three layered FFNN with BP training algorithm (Kim & Valdés 2003).



### Multiple linear regression (MLR)

MLR is a statistical tool for the investigation of linear relationships between a dependent variable ( $b$ ) and one or more independent variables ( $a_i$ ). The popular form of MLR is described as (Partovian et al. 2016):

$$b = y_0 + y_1 a_1 + y_2 a_2 + \dots + y_p a_p \quad (7)$$

where  $b$  is a dependent variable (predicted by a regression model),  $a_i (i = 1, 2, \dots, p)$  is the  $i$ th independent variable from the total set of  $p$  variables,  $y_i (i = 1, 2, \dots, p)$  is the  $i$ th coefficient corresponding to  $a$ ,  $y_0$  is intercept (or constant) and  $p$  is the number of independent variables (or number of coefficients).

### Efficiency criteria

Various typical performance evaluations such as determination coefficient (DC), CC, etc. were surveyed by Legates & McCabe (1999), who specified that the CC is not a proper criterion for the assessment of model forecasting. They showed that an ideal consideration of model efficiency includes a minimum of relative error measure or one goodness of fit (e.g. DC) and one or more absolute error measures (e.g. root mean square error (RMSE)). The model with more accurate results with regard to DC as Equation (8) and RMSE as Equation (9) in the training and validating steps can be specified through a process of trial and error.

Furthermore, considering that a rainfall time series, due to lack of rainfall for several days, may include many zero values, non-zero determination coefficient ( $DC_{0+}$ ), as Equation (10), can give a better insight to compare and evaluate the results of the models used in this study as well:

$$DC = 1 - \frac{\sum_{i=1}^N (O_{obs_i} - O_{com_i})^2}{\sum_{i=1}^N (O_{obs_i} - \bar{O}_{obs})^2} \quad (8)$$

$$RMSE = \sqrt{\frac{\sum_{i=1}^N (O_{obs_i} - O_{com_i})^2}{N}} \quad (9)$$

$$DC_{0+} = 1 - \frac{\sum_{i=1}^{N_0} (O_{obs_{0+}} - O_{com_{0+}})^2}{\sum_{i=1}^{N_0} (O_{obs_{0+}} - \bar{O}_{obs_{0+}})^2} \quad (10)$$

where  $O_{obs_i}$ ,  $O_{com_i}$ ,  $\bar{O}_{obs}$  and  $N$  are observed data, computed values, mean of observed data and number of observations and  $O_{obs_{0+}}$ ,  $O_{com_{0+}}$ ,  $\bar{O}_{obs_{0+}}$  and  $N_0$  are non-zero observed data, non-zero computed values, mean of non-zero observed data and number of non-zero observations, respectively. The small quantity for RMSE (down to zero) and high quantity for DC and  $DC_{0+}$  (up to one) represent the higher performance of the model.

Finally, the generated daily rainfall values should sum to the monthly rainfall at each station. The ability of the proposed models for this subject was also evaluated using a summability condition check (SCC) measure as Equation (11) (Nagesh Kumar et al. 2000), and then the DC for SCC was calculated as Equation (12):

$$\sum_{k=1}^n DR_{kj} = MR_j \quad j = 1, \dots, p \quad k = 1, \dots, n \quad (11)$$

$$DC \quad \text{for} \quad SCC = 1 - \frac{\sum_{i=1}^{N_0} (MR_{obs_i} - MR_{com_i})^2}{\sum_{i=1}^{N_0} (MR_{obs_i} - \overline{MR}_{obs})^2} \quad (12)$$

where  $DR$ ,  $MR$ ,  $MR_{obs_i}$ ,  $MR_{com_i}$ ,  $\overline{MR}_{obs}$ ,  $n$  and  $p$  are daily rainfall value, monthly rainfall value, observed monthly rainfall data, computed monthly rainfall values, mean of observed monthly rainfall data, number of days per month and number of months of the year, respectively.

## RESULTS AND DISCUSSION

To consider the efficiency of the proposed method, the WANN disaggregation model results were compared with the results of ANN and classical MLR models, and an accurate model was selected.

In the WANN disaggregation model, the time series were decomposed into sub-series at various scales with the wavelet transform at level  $X$ . The following formula has been proposed to define the maximum decomposition level of wavelet transform in the hybrid model (Nourani et al. 2009):

$$X = \text{int}[\log(M)] \quad (13)$$

where  $X$  and  $M$  are decomposition level and the number of time series data, respectively. For the study at hand,  $M = 6,149$  (daily time series from January 2000 to October 2016), so  $X = 3$ .

The number of epochs for ANN training was varied from 50 to 500 and the number of hidden layer neurons was changed from three to 20 for all input combinations, and the networks were trained for various input

combinations. In the ANN model, for rainfall disaggregation of Tabriz and Sahand stations, 12 input patterns were used, as presented respectively in Tables 2 and 3.

The results of ANN modeling for rainfall disaggregation at Tabriz and Sahand stations are shown in Tables 4 and 5, respectively. In Tabriz station, input pattern #11 led to the best structure, with an optimum epoch number of 190 and the optimal hidden number neurons of

**Table 2** | Different input patterns of ANN model at Tabriz rain-gauge station

Number of input patterns	Input pattern
1	$DR1(t) = f\{MR2(t), MR1(t)\}$
2	$DR1(t) = f\{MR3(t), DR3(t), MR2(t), MR1(t)\}$
3	$DR1(t) = f\{MR4(t), DR4(t), MR3(t), DR3(t), MR2(t), MR1(t)\}$
4	$DR1(t) = f\{MR5(t), DR5(t), MR4(t), DR4(t), MR3(t), DR3(t), MR2(t), MR1(t)\}$
5	$DR1(t) = f\{MR6(t), DR6(t), MR5(t), DR5(t), MR4(t), DR4(t), MR3(t), DR3(t), MR2(t), MR1(t)\}$
6	$DR1(t) = f\{MR6(t), DR6(t), MR5(t), DR5(t), MR4(t), DR4(t), MR3(t), DR3(t), MR1(t)\}$
7	$DR1(t) = f\{DR6(t), DR5(t), DR4(t), DR3(t), MR1(t)\}$
8	$DR1(t) = f\{MR6(t), DR6(t-1), MR5(t), DR5(t), MR4(t), DR4(t), MR3(t), DR3(t), MR2(t), MR1(t)\}$
9	$DR1(t) = f\{MR6(t), DR6(t), MR5(t), DR5(t-1), MR4(t), DR4(t), MR3(t), DR3(t), MR2(t), MR1(t)\}$
10	$DR1(t) = f\{MR6(t), DR6(t), MR5(t), DR5(t), MR4(t), DR4(t-1), MR3(t), DR3(t), MR2(t), MR1(t)\}$
11	$DR1(t) = f\{MR6(t), DR6(t), MR5(t), DR5(t), MR4(t), DR4(t), MR3(t), DR3(t-1), MR2(t), MR1(t)\}$
12	$DR1(t) = f\{MR6(t), DR6(t-1), MR5(t), DR5(t-1), MR4(t), DR4(t-1), MR3(t), DR3(t-1), MR2(t), MR1(t)\}$

Note: MR = monthly rainfall, DR = daily rainfall, 1 to 6 related to Tabriz, Sahand, Sarab, Maragheh, Bonab and Ahar stations, respectively.

**Table 3** | Different input patterns of ANN model at Sahand rain-gauge station

Number of input patterns	Input pattern
1	$DR2(t) = f\{MR2(t), MR1(t)\}$
2	$DR2(t) = f\{MR3(t), DR3(t), MR2(t), MR1(t)\}$
3	$DR2(t) = f\{MR4(t), DR4(t), MR3(t), DR3(t), MR2(t), MR1(t)\}$
4	$DR2(t) = f\{MR5(t), DR5(t), MR4(t), DR4(t), MR3(t), DR3(t), MR2(t), MR1(t)\}$
5	$DR2(t) = f\{MR6(t), DR6(t), MR5(t), DR5(t), MR4(t), DR4(t), MR3(t), DR3(t), MR2(t), MR1(t)\}$
6	$DR2(t) = f\{MR6(t), DR6(t), MR5(t), DR5(t), MR4(t), DR4(t), MR3(t), DR3(t), MR2(t)\}$
7	$DR2(t) = f\{DR6(t), DR5(t), DR4(t), DR3(t), MR2(t)\}$
8	$DR2(t) = f\{MR6(t), DR6(t-1), MR5(t), DR5(t), MR4(t), DR4(t), MR3(t), DR3(t), MR2(t), MR1(t)\}$
9	$DR2(t) = f\{MR6(t), DR6(t), MR5(t), DR5(t-1), MR4(t), DR4(t), MR3(t), DR3(t), MR2(t), MR1(t)\}$
10	$DR2(t) = f\{MR6(t), DR6(t), MR5(t), DR5(t), MR4(t), DR4(t-1), MR3(t), DR3(t), MR2(t), MR1(t)\}$
11	$DR2(t) = f\{MR6(t), DR6(t), MR5(t), DR5(t), MR4(t), DR4(t), MR3(t), DR3(t-1), MR2(t), MR1(t)\}$
12	$DR2(t) = f\{MR6(t), DR6(t-1), MR5(t), DR5(t-1), MR4(t), DR4(t-1), MR3(t), DR3(t-1), MR2(t), MR1(t)\}$

Note: MR = monthly rainfall, DR = daily rainfall, 1 to 6 related to Tabriz, Sahand, Sarab, Maragheh, Bonab and Ahar stations, respectively.

**Table 4** | The disaggregation results for Tabriz station using ANN model

Input pattern no.	Optimum epoch	Optimum ANN structure	DC		RMSE (mm)		Ranking
			Calibration	Verification	Calibration	Verification	
1	120	(2-11-1)	0.10	0.06	2.207	2.603	12
2	150	(4-5-1)	0.62	0.54	1.438	1.830	6
3	200	(6-5-1)	0.64	0.54	1.387	1.824	3
4	140	(8-6-1)	0.62	0.51	1.426	1.881	8
5	200	(10-6-1)	0.72	0.54	1.233	1.827	5
6	100	(9-10-1)	0.67	0.50	1.331	1.910	9
7	140	(5-7-1)	0.67	0.54	1.330	1.824	4
8	120	(10-5-1)	0.65	0.52	1.367	1.857	7
9	100	(10-5-1)	0.66	0.56	1.359	1.795	2
10	140	(10-7-1)	0.58	0.45	1.501	1.993	10
11	190	(10-5-1)	0.62	0.59	1.442	1.725	1
12	200	(10-5-1)	0.14	0.09	2.151	2.565	11

Note: DC = determination coefficient; RMSE = root mean square error.

**Table 5** | The disaggregation results for Sahand station using ANN model

Input pattern no.	Optimum epoch	Optimum ANN structure	DC		RMSE (mm)		Ranking
			Calibration	Verification	Calibration	Verification	
1	120	(2-12-1)	0.10	0.07	2.004	2.187	12
2	140	(4-5-1)	0.58	0.46	1.359	1.670	4
3	130	(6-5-1)	0.63	0.47	1.274	1.650	3
4	110	(8-5-1)	0.71	0.42	1.136	1.727	9
5	110	(10-6-1)	0.65	0.45	1.240	1.672	6
6	130	(9-5-1)	0.66	0.45	1.238	1.672	5
7	150	(5-6-1)	0.65	0.36	1.254	1.808	10
8	170	(10-5-1)	0.63	0.44	1.281	1.700	8
9	140	(10-5-1)	0.63	0.57	1.278	1.480	1
10	140	(10-6-1)	0.60	0.45	1.340	1.684	7
11	120	(10-8-1)	0.71	0.53	1.138	1.549	2
12	130	(10-8-1)	0.22	0.12	1.860	2.121	11

Note: DC = determination coefficient; RMSE = root mean square error.

five. The DC in calibration was 0.62 and in validation was 0.59. For Sahand station, input pattern #9 led to the best results among all the input patterns, with an optimum epoch number of 140 and the optimal hidden number neurons of five. The DC in calibration was 0.63 and in validation was 0.57. Results show that the rainfall of all stations is important in the disaggregation model. In

Tabriz station, according to the province's prevailing wind direction, which is from east to west, the effect of rainfall one day ago at Sarab at East of Tabriz station was detected to be significant in the disaggregation model (input pattern #11). Similarly, the effect of rainfall on the previous day at the Bonab station was dominant in disaggregation of Sahand station rainfall (input patterns #9).

Two reasons for better results of #9 and #11 input patterns and low performances of other input patterns for disaggregation of Tabriz and Sahand stations' rainfall time series are the altitudes of stations and the mountains between them. Tabriz, Sahand and Bonab stations have almost the same altitudes and there is no mountainous obstacle between them, whereas Sarab station has high altitude compared with previous stations but there is no special mountain barrier between them. Regarding Maragheh and Ahar stations, there are mountainous obstacles between these stations and Tabriz and Sahand stations.

The overall results of the ANN model in rainfall disaggregation show an acceptable performance of modeling.

Regardless of the ANN flexibility for modeling and simulation of non-linear climatological processes, some deficiencies may arise in the disaggregation process due to the non-stationarity and seasonality of signal oscillations, which may change over different timescales. The wavelet transform is a proper temporal pre-processing method which can be utilized to extract many specifications from the data, such as long-term and short-term fluctuations, by decomposing the time series into various sub-series. So, in the next step, the pre-processed data (obtained sub-series from discrete wavelet transform (DWT)) after ranking by MI and CC criteria were imposed into the ANN model to upgrade the disaggregation precision. In the present research, the effects of the used mother wavelet type and the decomposition level on the overall performance of the modeling were examined. Therefore, time series were decomposed by four various types of wavelet transforms, i.e. *coif1*, *db2*, *Haar*, and *sym3* (Mallat 1989). In Figure 5, the wavelet-based rainfall time series decomposition results at level 3 via *sym3* wavelet for Tabriz station are presented.

The results of WANN modeling for rainfall disaggregation at Tabriz and Sahand stations are shown in Tables 6 and 7, respectively.

In WANN models, due to a large number of inputs (sub-series), noise may be imposed to the modeling and despite the training improvement, the validation results would not be appropriate. So, in the suggested hybrid model, the obtained sub-series were first ranked by MI or CC criteria, and dominant inputs among all potential input sub-series were selected using the Student's t-test (Ruxton 2006) and were used as inputs of the WANN model for disaggregating

the monthly rainfall time series to the daily time series. Based on the Student's t-test, for both Sahand and Tabriz stations, using MI and CC ranking methods, the first ten and seven sub-series had significant differences from another sub-series and were selected as the inputs, respectively. In a non-linear complicated hydro-climatological process, despite a weak linear relation, a strong non-linear relation may exist between output and input variables. Hence, in these cases where methods based on a linear relationship (i.e. CC) may lead to an inappropriate result, the information content (i.e. MI) can be a proper selection to diagnose specifications in complicated classification tasks (Nourani et al. 2015). For this reason, in this study, in addition to the CC, the non-linear MI measure was also examined for selecting dominant inputs.

According to Tables 6 and 7 for Tabriz station, the best structure was obtained by the *sym3* mother wavelet with 110 training epochs and seven hidden neurons with DCs of calibration and validation as 0.80 and 0.72, respectively. In Sahand station, the best structure was obtained by the *coif1* mother wavelet with 100 training epochs and five hidden neurons with DCs of calibration and validation as 0.79 and 0.69, respectively.

For both stations, the model whose inputs were selected by the MI ranking method led to better results with regard to the CC criterion (see Tables 6 and 7), and the results of MI input selection showed adaptation with the geomorphology of the basin (Figure 1). In other words, rainfall time series related to nearby stations, as well as stations with a lower altitude difference, to the considered stations showed more efficiency in the modeling performance.

According to Figure 1 and also the selected sub-series by MI, Ahar station has less effect in the modeling due to the higher slope and the great difference in height from Tabriz and Sahand stations. Also, Maragheh station shows less effect because of the mountains between it and both Tabriz and Sahand stations. However, the relative slopes of Bonab and Sarab stations to Tabriz and Sahand stations are low, and there are few mountains between them. Therefore, they showed a higher impact on the Tabriz and Sahand stations' rainfall.

The scatter plot of observed versus disaggregated rainfall using an optimal WANN model for calibration and verification periods at Tabriz and Sahand stations are shown in Figures 6 and 7, respectively.

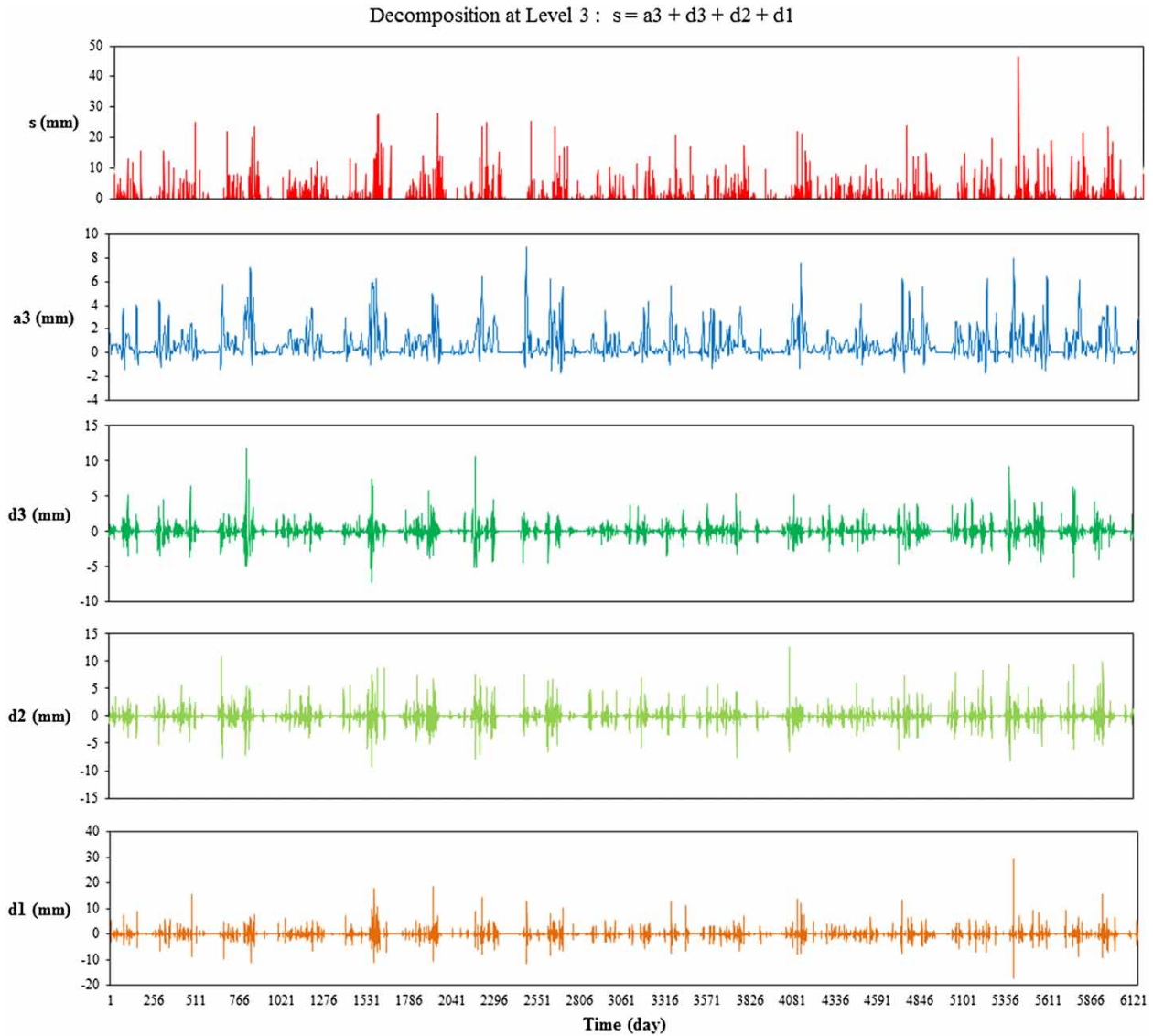

**Figure 5** | Approximation and details of sub-signals of Tabriz station rainfall time series by sym3 wavelet (level 3).

**Table 6** | The results of disaggregation model for Tabriz station by WANN model (level = 3)

Ranking method	Wavelet type	Optimum Epoch	Optimum ANN structure	DC		RMSE (mm)		Ranking
				Calibration	Verification	Calibration	Verification	
With MI	coif1	110	(10-5-1)	0.79	0.69	1.063	1.495	3
	db2	200	(10-8-1)	0.78	0.67	1.088	1.542	4
	Haar	170	(10-6-1)	0.78	0.60	1.087	1.712	7
	sym3	110	(10-7-1)	0.80	0.72	1.037	1.436	1
With CC	coif1	190	(7-5-1)	0.74	0.70	1.183	1.471	2
	db2	200	(7-5-1)	0.75	0.61	1.160	1.678	5
	Haar	180	(7-5-1)	0.78	0.60	1.088	1.699	6
	sym3	170	(7-5-1)	0.73	0.57	1.206	1.761	8

Note: DC = determination coefficient; RMSE = root mean square error.

**Table 7** | The results of disaggregation model for Sahand station by WANN model (level = 3)

Ranking method	Wavelet type	Optimum Epoch	Optimum ANN structure	DC		RMSE (mm)		Ranking
				Calibration	Verification	Calibration	Verification	
With MI	coif1	100	(10-5-1)	0.79	0.69	0.963	1.255	1
	db2	140	(10-5-1)	0.76	0.64	1.030	1.354	2
	Haar	130	(10-6-1)	0.74	0.63	1.072	1.377	3
	sym3	180	(10-6-1)	0.75	0.59	1.051	1.445	5
With CC	coif1	180	(7-5-1)	0.78	0.63	0.986	1.386	4
	db2	130	(7-5-1)	0.79	0.57	0.963	1.482	7
	Haar	150	(7-5-1)	0.77	0.54	1.007	1.534	8
	sym3	160	(7-5-1)	0.76	0.59	1.030	1.448	6

Note: DC = determination coefficient; RMSE = root mean square error.

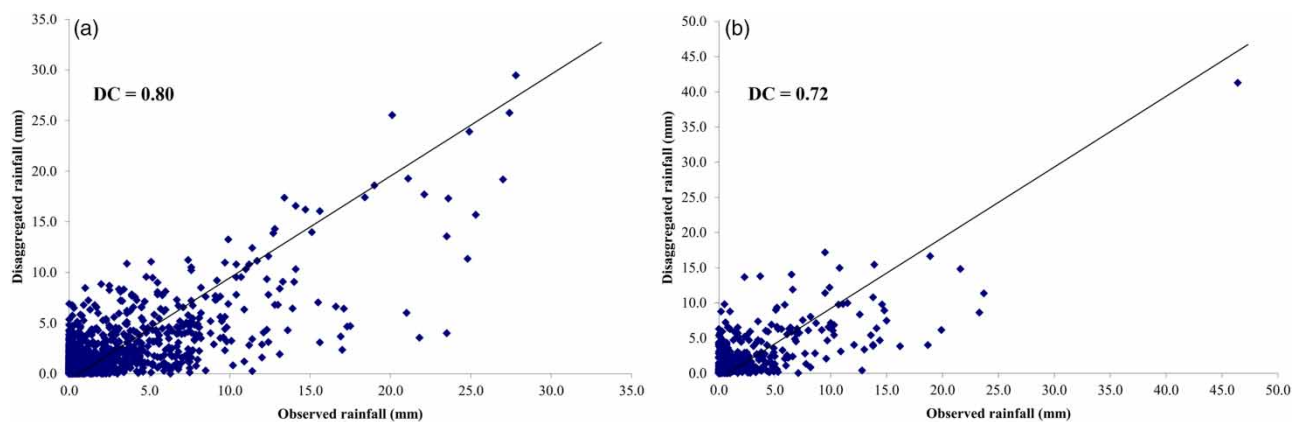
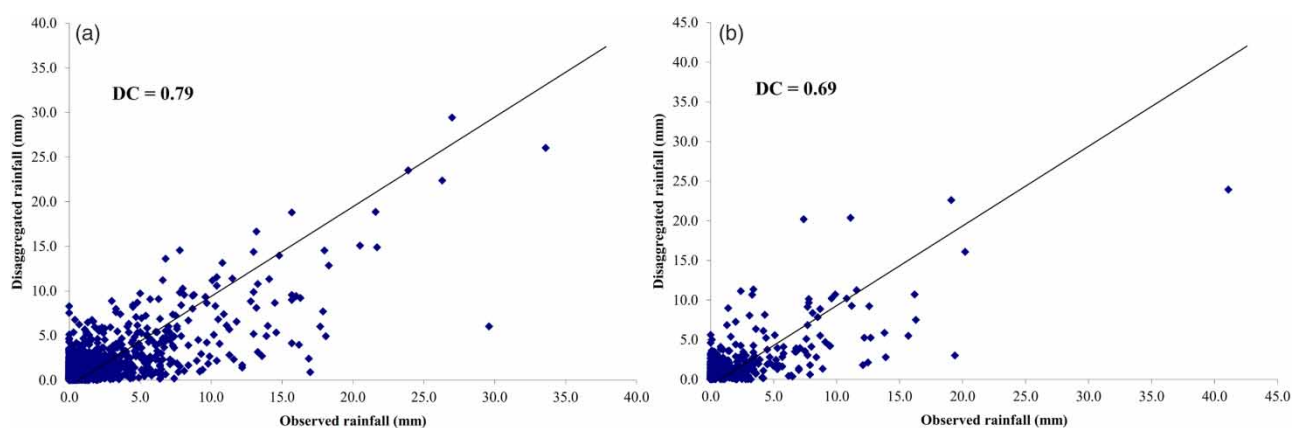
**Figure 6** | Scatter plot of observed versus disaggregated rainfall (in mm) using WANN at Tabriz station for (a) calibration period, (b) verification period.**Figure 7** | Scatter plot of observed versus disaggregated rainfall (in mm) using WANN at Sahand station for (a) calibration period, (b) verification period.

To further evaluate the proposed hybrid method, a classic MLR disaggregation model was also used for disaggregating the monthly to daily rainfall time series for

both stations. The best relationship between the dependent and independent variables for Tabriz and Sahand stations in the MLR model was obtained by the following equations,

respectively (parameters have been demonstrated in footnote of Tables 2 and 3):

$$\begin{aligned} DR1(t) = & 0.0002 + 0.0328MR1(t) + 0.0001MR2(t) \\ & - 0.0068MR3(t) + 0.2078DR3(t) - 0.0078MR4(t) \\ & + 0.2360DR4(t) - 0.0034MR5(t) + 0.1042DR5(t) \\ & - 0.0078MR6(t) + 0.2328DR6(t) \end{aligned} \quad (14)$$

$$\begin{aligned} DR2(t) = & 0.0005 - 0.00003MR1(t) + 0.0331MR2(t) \\ & - 0.0064MR3(t) + 0.1922DR3(t) - 0.0039MR4(t) \\ & + 0.1153DR4(t) - 0.0077MR5(t) + 0.2372DR5(t) \\ & - 0.0057MR6(t) + 0.1717DR6(t) \end{aligned} \quad (15)$$

According to the obtained Equations (14) and (15), the independent variables (inputs) with larger coefficients have great effects on the output. For both stations, the effects of daily time series of all stations are significant. For Tabriz and Sahand stations, in addition to the daily time series, Tabriz and Sahand stations' monthly time series were also effective. The results of the ANN model have been compared with these results. The comparison indicated the modeling efficiency. By comparing the results of this model with two other models, it can be seen that the results are poor, which is due to the linear nature of the model. Comparison of the obtained results by all applied methods (i.e. ANN, WANN and MLR) is shown in Table 8. The results demonstrate that the WANN disaggregation model could have more reliable results as opposed to the other two models. Obviously, the MLR method could not treat a complicated non-linear process due to its linear nature. However, when ANN is used to reconstruct the wavelet-based sub-signals, its non-linear nature could help the model to discover and obtain non-linear specifications of the phenomenon. Overall, the wavelet transform

application to the rainfall time series increased the capability of the ANN rainfall disaggregation models up to 22% by eliminating noise and revealing the dominant periods and assigning appropriate weight to each sub-series.

Considering that there is no rainfall on most days of the rainfall time series, it is necessary to examine the capability of the proposed model to compare and evaluate the models with the  $DC_{0+}$  criterion. The results of  $DC_{0+}$  in Table 8 show that the WANN disaggregation model could lead to more reliable results compared with the other two models in this case.

The generated daily rainfalls should sum to the monthly rainfalls at each station; the ability of the proposed models for this subject was also evaluated using the SCC method (Nagesh Kumar *et al.* 2000). The results presented in Table 8 show the better results of the WANN disaggregation model with regard to other models, according to the computed SCC values.

## CONCLUSIONS

In this study, for disaggregating the Tabriz and Sahand stations' rainfall time series, the daily rainfall time series of six stations of Urmia Lake basin (Tabriz, Sahand, Sarab, Maragheh, Bonab, and Ahar) were used. The disaggregation was performed using daily data of only four rain-gauges (Sarab, Maragheh, Bonab, and Ahar) and monthly data from all rain-gauges. For this purpose, a hybrid WANN model was used, which uses a method to extract several features from the data by decomposing the time series into various sub-series. The generated results were also

**Table 8** | Comparison of the obtained results by all methods (i.e. ANN, WANN, MLR)

Model	Model type	Case Study	DC		RMSE (mm)		$DC_{0+}$ Verification	DC for SCC Verification
			Calibration	Verification	Calibration	Verification		
MLR	Linear	Tabriz	0.53	0.51	1.595	1.889	0.39	0.53
ANN	Non-linear		0.62	0.59	1.442	1.725	0.52	0.75
WANN	Hybrid		0.80	0.72	1.037	1.436	0.66	0.92
MLR	Linear	Sahand	0.55	0.49	1.408	1.614	0.34	0.62
ANN	Non-linear		0.63	0.57	1.278	1.480	0.50	0.72
WANN	Hybrid		0.79	0.69	0.963	1.255	0.62	0.89

Note: DC = determination coefficient; RMSE = root mean square error; SCC = summability condition check.

compared with ANN and MLR models. The results demonstrate that the WANN disaggregation model has a higher accuracy because of the wavelet transform capability to decompose the time series to low and high frequencies by providing multi-scale features. In the present study, the effect of wavelet transform type on the model efficiency was also investigated using four different kinds of wavelet transforms: Haar, sym3, db2, and coif1. The performance of the WANN model with regard to ANN and classical MLR models at validation stage in the optimized case for Tabriz rain-gauge was increased up to 22 and 41.2% and in the optimized case for Sahand rain-gauge up to 21.1 and 40.8%, respectively. It was concluded that the hybrid WANN model can be considered as an accurate disaggregation model to disaggregate the hydro-climatological time series. In the present study, the effect of CC and MI criteria in sub-series selection was also examined. The performance of MI with regard to CC criteria was increased because a strong non-linear relation may exist between output and input variables. The results showed that rainfall time series related to nearby stations as well as stations with a lower altitude difference from the considered stations have more efficiency in the modeling performance.

In the case of data availability, the proposed hybrid method may be used to disaggregate the time series to further fine scales (e.g. hourly) or to apply for disaggregation of other hydro-climatologic parameters. It is also suggested to use the proposed method for downscaling the GCM data (Wilby & Wigley 1997) and compare the results with other commonly used methods used for GCM data (e.g. statistical downscaling model (SDSM) and Long Ashton research station weather generator (LARS-WG)) (Zulkarnain et al. 2014). It is also recommended to use other AI models as SVM in combination with wavelet transform to disaggregate the rainfall time series and other hydro-climatologic parameters and examine the results with other efficiency criteria (e.g. bias metrics).

## REFERENCES

- Addison, P., Murray, K. & Watson, J. 2001 [Wavelet transform analysis of open channel wake flows](#). *J. Eng. Mech. ASCE* **127** (1), 58–70.
- ASCE Task Committee on Application of Artificial Neural Networks in Hydrology 2000 [Artificial neural networks in hydrology. II: hydrologic applications](#). *J. Hydrol. Eng.* **5** (2), 124–137.
- Brown, I. 2012 *An Empirical Comparison of Benchmarking Methods for Economic Stock Time Series*. U.S. Census Bureau, Washington, DC.
- Burian, S. & Durrans, S. 2002 [Evaluation of an artificial neural network rainfall disaggregation model](#). *Water Sci. Technol.* **45** (2), 99–104.
- Burian, S., Durrans, S., Tomić, S., Pimmel, R. & Wai, C. N. 2000 [Rainfall disaggregation using artificial neural networks](#). *J. Hydrol. Eng.* **5** (3), 299–307.
- Burian, S., Durrans, S., Nix, S. & Pitt, R. 2001 [Training artificial neural networks to perform rainfall disaggregation](#). *J. Hydrol. Eng.* **6** (1), 43–51.
- Chen, B. 2007 *An Empirical Comparison of Methods for Temporal Disaggregation at the National Accounts*. Bureau of Economic Analysis, Washington, DC.
- Choi, J., Socolofsky, S. & Olivera, F. 2008 [Hourly disaggregation of daily rainfall in Texas using measured hourly precipitation at other locations](#). *J. Hydrol. Eng.* **13** (6), 476–487.
- Dhekale, B. S., Nageswararao, M. M., Nair, A., Mohanty, U. C., Swain, D. K., Singh, K. K. & Arunbabu, T. 2017 [Prediction of kharif rice yield at Kharagpur using disaggregated extended range rainfall forecasts](#). *Theor. Appl. Climatol.* **1** (1), 1–17.
- Econopouly, T., Davis, D. & Woolhiser, D. 1990 [Parameter transferability for a daily rainfall disaggregation model](#). *J. Hydrol.* **118** (1–4), 209–228.
- Foufoula-Georgiou, E., Kumar, P., Mukerji, T. & Mavko, G. 1995 [Wavelets in geophysics](#). *Pure Appl. Geophys.* **145** (2), 374–375.
- Garcia-Guzman, A. & Aranda-Oliver, E. 1993 [A stochastic model of dimensionless hyetograph](#). *Water Resour. Res.* **29** (7), 2363–2370.
- Grossmann, A. & Morlet, J. 1984 [Decomposition of hardy functions into square integrable wavelets of constant shape](#). *SIAM J. Math. Anal.* **15** (4), 723–736.
- Guenni, L. & Bardossy, A. 2002 [A two steps disaggregation method for highly seasonal monthly rainfall](#). *Stoch. Environ. Res. Risk Assess.* **16** (3), 188–206.
- Gyasi-Agyei, Y. 2005 [Stochastic disaggregation of daily rainfall into one-hour time scale](#). *J. Hydrol.* **309** (1–4), 178–190.
- Hansen, J. W. & Ines, A. V. M. 2005 [Stochastic disaggregation of monthly rainfall data for crop simulation studies](#). *Agric. For. Meteorol.* **131** (3–4), 233–246.
- Hershendorff, J. & Woolhiser, D. 1987 [Disaggregation of daily rainfall](#). *J. Hydrol.* **95** (3–4), 299–322.
- Kim, S. & Singh, V. 2015 [Spatial disaggregation of areal rainfall using two different artificial neural networks models](#). *Water* **7** (6), 2707–2727.
- Kim, T. W. & Valdés, J. 2003 [Nonlinear model for drought forecasting based on a conjunction of wavelet transforms and neural networks](#). *J. Hydrol. Eng.* **8** (6), 319–328.
- Kim, T. Y., Oh, K. J., Kim, C. & Do, J. D. 2004 [Artificial neural networks for non-stationary time series](#). *Neurocomputing* **61**, 439–447.



- Kim, S., Kisi, O., Seo, Y., Singh, V. P. & Lee, C. 2016 Assessment of rainfall aggregation and disaggregation using data-driven models and wavelet decomposition. *Hydrol. Res.* **48** (1), 1–18.
- Knoesen, D. & Smithers, J. 2009 The development and assessment of a daily rainfall disaggregation model for South Africa. *Hydrol. Sci. J.* **54** (2), 217–233.
- Koutsoyiannis, D. 1988 *A Disaggregation Model of Point Rainfall*. PhD Dissertation, National Technical University of Athens, Athens, Greece.
- Koutsoyiannis, D. 2002 The Hurst phenomenon and fractional Gaussian noise made easy. *Hydrol. Sci. J.* **47** (4), 573–595.
- Koutsoyiannis, D. & Manetas, A. 1996 Simple disaggregation by accurate adjusting procedures. *Water Resour. Res.* **32** (7), 2105–2117.
- Koutsoyiannis, D. & Montanari, A. 2015 Negligent killing of scientific concepts: the stationarity case. *Hydrol. Sci. J.* **60** (7–8), 1174–1183.
- Koutsoyiannis, D. & Pachakis, D. 1996 Deterministic chaos versus stochasticity in analysis and modeling of point rainfall series. *J. Geophys. Res. Atmos.* **101** (D21), 26441–26451.
- Koutsoyiannis, D. & Xanthopoulos, T. 1990 A dynamic model for short-scale rainfall disaggregation. *Hydrol. Sci. J.* **35** (3), 302–322.
- Koutsoyiannis, D., Onof, C. & Wheeler, H. S. 2003 Multivariate rainfall disaggregation at a fine timescale. *Water Resour. Res.* **39** (7), 1173–1191.
- Labat, D. 2005 Recent advances in wavelet analyses: part 1. A review of concepts. *J. Hydrol.* **314** (1–4), 275–288.
- Legates, D. & McCabe Jr., G. 1999 Evaluating the use of ‘goodness-of-fit’ measures in hydrologic and hydroclimatic model validation. *Water Resour. Res.* **35** (1), 233–241.
- Lombardo, F., Volpi, E. & Koutsoyiannis, D. 2012 Rainfall downscaling in time: theoretical and empirical comparison between multi fractal and Hurst-Kolmogorov discrete random cascades. *Hydrol. Sci. J.* **57** (6), 1052–1066.
- Mallat, S. 1989 A theory for multi resolution signal decomposition: the wavelet representation. *IEEE Trans. Pattern Anal. Mach. Intell.* **11** (7), 674–693.
- Nagesh Kumar, D., Lall, U. & Peterson, M. 2000 Multi-site disaggregation of monthly to daily streamflow. *Water Resour. Res.* **36** (7), 1823–1833.
- Nourani, V., Komasi, M. & Mano, A. 2009 A multivariate ANN-Wavelet approach for rainfall–runoff modeling. *Water Resour. Manage.* **23**, 2877–2894.
- Nourani, V., Khanghah, T. R. & Baghanam, A. H. 2015 Application of entropy concept for input selection of Wavelet-ANN based rainfall–runoff modeling. *J. Environ. Inform.* **26** (1), 52–70.
- Partovian, A., Nourani, V. & Alami, M. T. 2016 Hybrid denoising-jittering data processing approach to enhance sediment load prediction of muddy rivers. *J. Mt. Sci.* **13** (12), 2135–2146.
- Poole, D. L. & Mackworth, A. K. 2017 *Artificial Intelligence: Foundations of Computational Agents*, 2nd edn. BMJ Cambridge University Press, New York, pp. 820.
- Rashid, M., Beecham, S. & Chowdhury, R. 2015 Statistical downscaling of rainfall: a non-stationary and multi-resolution approach. *Theor. Appl. Climatol.* **124** (3–4), 919–933.
- Rogers, R. 1996 *Neural Networks: A Systematic Introduction*. Springer, Berlin.
- Ruxton, G. D. 2006 The unequal variance t-test is an underused alternative to Student’s t-test and the Mann–Whitney U test. *Behav. Ecol.* **17** (4), 688–690.
- Sivakumar, B., Sorooshian, S., Gupta, H. V. & Gao, X. 2001 A chaotic approach to rainfall disaggregation. *Water Resour. Res.* **37** (1), 61–72.
- Socolofsky, S., Adams, E. & Entekhabi, D. 2001 Disaggregation of daily rainfall for continuous watershed modeling. *J. Hydrol. Eng.* **6** (4), 300–309.
- Swinscow, T. D. V. & Campbell, M. J. 1997 *Statistics at Square One*, 9th edn. BMJ Publishing Group, University of Southampton, London, pp. 140.
- Trzaska, S. & Schnarr, E. 2014 *A Review of Downscaling Methods for Climate Change Projections*. Tetra Tech ARD, California, pp. 140.
- Wilby, R. L. & Wigley, T. M. L. 1997 Downscaling general circulation model output: a review of methods and limitations. *Prog. Phys. Geogr.* **21** (4), 530–548.
- Woolhiser, D. & Osborn, H. 1985 A stochastic model of dimensionless thunderstorm rainfall. *Water Resour. Res.* **21** (4), 511–522.
- Zarris, D., Koutsoyiannis, D. & Karavokiros, G. 1998 A simple stochastic rainfall disaggregation scheme for urban drainage modelling. In: *Proc. Fourth Int. Conf. on Developments in Urban Drainage Modelling* (D. Butler & C. Maksimovic, eds). International Association of Water Quality, International Association of Hydraulic Research, UNESCO, Imperial College, London, pp. 85–92.
- Zhang, J., Murch, R., Ross, M., Ganguly, A. R. & Nachable, M. 2008 Evaluation of statistical rainfall disaggregation methods using rain-gauge information for west-central Florida. *J. Hydrol. Eng.* **13** (12), 1158–1169.
- Zulkarnain, H., Supiah, S. H. & Sobri, H. 2014 Application of SDSM and LARS-WG for simulating and downscaling of rainfall and temperature. *Theor. Appl. Climatol.* **116** (1–2), 243–257.

First received 24 May 2018; accepted in revised form 2 August 2018. Available online 30 August 2018