

**DMD2022-1054****NON-INVASIVE DIAGNOSIS OF DEEP VEIN THROMBOSIS TO EXPEDITE TREATMENT  
AND PREVENT PULMONARY EMBOLISM DURING GESTATION**

**Dolly Maiti**  
Department of  
Cardiovascular  
Medicine, Mayo  
Clinic, Rochester,  
MN

**Shivaram P.  
Arunachalam**  
Department of Medicine  
and Radiology, Mayo  
Clinic  
Rochester, MN

**ABSTRACT**

*Deep vein thrombosis (DVT) is the formation of thrombosis or blood clot in the deep veins of the body, usually in the lower extremities or pelvic vein. During this time, a hypercoagulable state results in a higher rate of deep vein thrombosis (DVT) and pulmonary embolism (PE) during gestation and the postnatal stage. PE is the leading cause of maternal death, making early diagnosis and clinical treatment vital to both the mother's and fetal life.*

*The current technologies for the diagnosis of DVT reduced detection accuracy with increased depth, false negatives when parallel veins are present, and the incompetence of imaging due to factors such as obesity and edema. The drawback of compression ultrasound is that clots may emboli during diagnosis and travel to vital organs such as the heart. In this study a new technological advancement is explored to superior diagnostic methods, and a near infrared device will be able to provide relative measurements of the oxygenation levels of calf veins and can help identify excessive deoxygenation and specific locations. Oxyhemoglobin & deoxyhemoglobin absorbs red light and infra-red lights differently. Oxygenated blood gets absorbed by IR light while deoxygenated gets transmitted. When infrared light is emitted onto a vein, it gets absorbed by the oxygenated hemoglobin and gives an absorbance ratio of output to the input close to 1. Infrared radiation spectroscopy measurements can indicate  $\Delta^{1/2}HbO_2$  and  $\Delta^{1/2}Hb$  to show a comparison, helping to indicate the presence or absence of a clot. . The circuit is designed with capacitors, resistors, and transistors to act as filters and triggers to pulsate at 20Hz, to pick up biological signals. An Arduino Uno microcontroller helped to process data in order*

*to analyze signal proximity to 0 or 1 to classify DVT and validate the efficacy of using IR for DVT detection*

*Testing of the device allowed for a functionality check to understand whether it was able to pick up signals of oxygenation levels. The 3 tests have insight on the potential of the device; however, the results were inconclusive, due to a lack of sufficient testing. The limitation has been the inability to test on a large sample size and insufficient data, therefore it can't be said for now whether IR is an effective way of diagnosing DVT. However, since on localized testing, the device seems to be gathering programmed signals, the research can be furthered, and the efficacy can be proved by testing on expecting patients.*

**Keywords:** Place any keywords here

**1. INTRODUCTION**

Venous thromboembolism (VTE) a type of thromboembolic event which accounts for significant morbidity and mortality. More than 200,000 individuals develop venous thrombosis (DVT) annually of which about 50,000 result in pulmonary embolism [7]. In the developing world 0.5 to 3 per 1,000 pregnancies occur every year.[1] Pregnant woman and post-partum mothers have a 4.3 times greater risk of being afflicted with deep vein thrombosis than non-mothers, with 64% of cases occurring in cesarean delivery.[2] A reduction of venous flow velocity of 50% takes place in the 3rd trimester. This can last until approximately 6 weeks postpartum causing severe swelling and painful or limited range of movement. [2] These painful clots can dislodge and travel into vital organs to cause fatal damage to the mother, and in turn the fetus. Pulmonary Embolism (PE) is a blood clot in the lungs which restricts air

flow and damages the lungs, if the clot is large enough can result in death, hence it is vital to diagnose Deep Vein Thrombosis (DVT) in time and provide prompt treatment.

The existing methods of DVT diagnosis are of both invasive and non-invasive type, however each has its shortcomings. A negative D-dimer assay suggests that thrombosis is not developed, eliminating DVT from the diagnosis spectrum. If the result of a D-dimer test is positive, it can indicate that there indicates the presence of thrombosis, however, cannot be used as the sole test for diagnosis as a false positive can result from inflammation, trauma, liver disease, and most importantly for this study, pregnancy. The D-dimer test has serious inconsistencies accompanied by a low quality of results after extensive testing. [3] Venography is considered the gold standard for the diagnosis of lower extremity DVT. However, the most prominent drawback of venography is that it is invasive and can cause discomfort to patients. This technique of diagnosis can't be used for patients with renal insufficiency and severe allergies to the contrast medium. Further disadvantages are high rate of incompetent visualization (20%), failure of cannulation (5%), and high variability in results due to difficulties in result interpretation.[4] Ultrasound (US) is widely used for DVT diagnosis and is usually the first test of diagnosis. While ultrasonography has the advantage over venography for being non-invasive and has high sensitivity and is sufficiently reliable. US evaluation for DVT is often combined with Doppler imaging, to aid with the characterization of the degree of obstruction. Ultrasound does not identify calf vein DVT reliably.

The efforts to prevent from venous thromboembolism diseases are important in all at risk patients, perhaps even more so in expecting mothers, as the impact of can be severe to the patients. While, most research currently focus on diagnosis after ailment, not in early diagnosis. Therefore, there is a research gap in the of area early diagnosis of DVT for prevention of PE.

Currently, the diagnosis of Deep Vein Thrombosis uses ultrasonography method or venography for invasively for serious cases. The problem that always occurs during interpretation of ultrasound images are degradation of the details and edge definition due to speckle noises existence. This problem leads incorrect diagnosis and or the need for repetitive testing. Therefore, there is a need for a non-invasive diagnostic method which can give reduced diagnostic time and avoid this problem to help to improve the research.

Upon conducting background research, it can be hypothesized that near-infrared (NIR) light should be able to differentiate between levels of oxygenated and deoxygenated hemoglobin to determine the presence of a clot, and wireless IR DVT testing will prove to be an effective method of early detection of DVT to prevent occurrence of PE.

This project aims to utilize the concepts of near-infrared radiation spectroscopy (NIRS) to detect DVT through biochemical changes. The non-invasive nature of NIR will limit harm to the fetus. The development of a cost-efficient device would provide advancement in diagnostics and would eliminate the need for expensive testing.

The aim of this project is to track the oxygenation levels of a vein for early diagnosis of DVT. To achieve the aim of this project, the following objectives have been set up:

1. To determine the efficacy of Infra-Red Radiation in detecting Deep Vein Thrombosis.
2. To expedite diagnosis and prevent pulmonary embolism during gestation should Infra-Red Radiation be effective.
3. To develop an accompanying low cost and portable hardware for collecting the data.

## 2. MATERIALS AND METHODS

The methodology for this study was broken down into sections within certain time frames to allow for a comprehensive timely study. The initial step of the study was to conduct a literature survey, select components, design and build the device, data acquisition and post processing, then finally analysis and validation. Due to a global pandemic, the research was halted, and the sufficient data collection and testing could not be done.

**Designing Device:** A low-cost portable hardware was developed to collect data for IR efficacy validation. The device must consist of Velcro or elastic adjustable sleeve probe containing light source and detector elements.

The NIR light source is a small LED in the IR light spectrum. The light best absorbed by biological tissue is about 720-940nm, which is red in the visible light spectrum. A detector will pick up on the light transmitted, in turn giving information about the light absorbed. This absorbance is directly indicative of the  $[HbO_2]$  and  $[Hb]$ . [5] For this purpose of detection, a phototransistor was utilized. A phototransistor is controlled by exposure to light. Phototransistors have two leads which connect internally with its collector and emitter (or source and drain in FET). The base of transistor responds to light and controls the flow of current between the leads. The TCRT 5000 was utilized as the reflective optical sensor, as it contains the LED and phototransistor on the same module greater improved efficiency.

The probe (Figure 1) was connected via a control module for the purpose of coding and filtering the information picked up by the probe. The control module is responsible for storing coded information which will be used to filter out access information and keep relevant data, as well as storing this data. For this device purpose, a microcontroller is the best suited control module as there is low time required for performing operations, the chips are small and flexible, and are highly integrable.

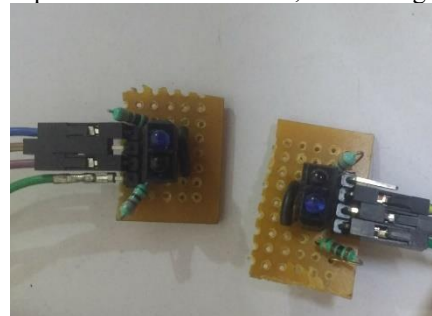

Figure 1: The probes constructed from TCRT 5000 and resistors.

For infrared absorption spectra display, a serial oscilloscope was utilized with a programming software capable of post-processing of incoming data and spectra, for easier and faster analysis. Eventually this can be integrated into the control module for a portable device.

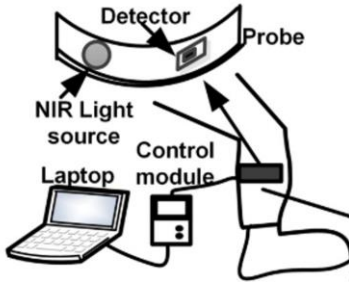

Figure 2: Project Design: module and display[6]

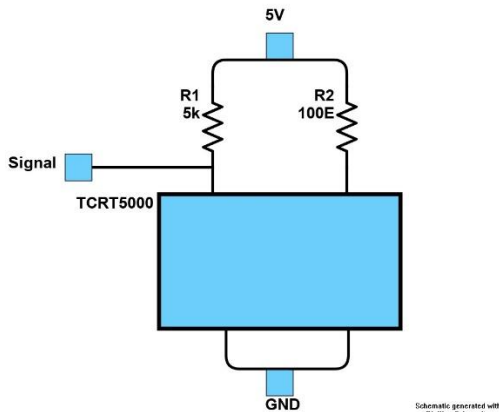

Figure 3: Project Design: module and display[6]

### Circuit Design:

Figure 3 illustrated the circuitry devised onto the PCB. A 5kΩ resistor is biased to the photo transistor, so that the signal is not saturated. The 100Ω acts as current protection for the IR LED, which was connected via the 100Ω resistor to D6 of the Arduino. The signal of the Xtor passed to the A3 of the Arduino, giving an output in voltage. The Arduino is powered by a 5V supply.

**Software and Analysis:** The data is acquired at the analogue port of the microcontroller module and is processed for analogue to digital conversion. The microcontroller code further performs the filtering of signal acquired. Post filtering of the signals acquired from both the sensors, the ratio between the two is calculated. The closer the ratio is towards one, the lesser the chances of a clot being found since the probability of finding a clot in the exact same spots on both legs is rather low. The farther the deviation of the ratio from one in either direction, is significant of the presence of a clot.

Figure 4 shows the hardware module which was used for preliminary testing. Two probes were used to be placed on both calves, attached to the Arduino control module.

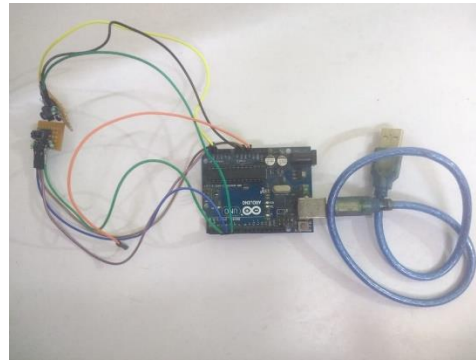

Figure 4: Top left: TCRT 5000 based probes. Middle: Arduino control module. Right: Connection for display.

**Testing:** Once the device was constructed, initial testing was conducted on a study team member's leg to verify the signal as indication of absorbance was occurring. Upon placement on the calf, there was a change observed in the graph of absorbance. Version 1.0 of the hardware, utilized a 555 timer IC, to pulsate the signal in order to detect on the signal of desired frequency, resulting in noise reduction. It was later integrated into the program, by simply adding it to the software which pulsated the TCRT 5000 in Version 2.0. As the signal is not a pulsating, like that detected by a pulse oximeter, and based on the absorbance of the light, graph will not show a symmetrical wave.

Once signal detection was confirmed, the testing phase was started on local participants, after gaining verbal consent. These gave just a few results to confirm the efficiency of the device, however, further testing in DVT positive patients is required for validation.

### 3. RESULTS AND DISCUSSION

As a result of the global pandemic COVID-19, data collection was difficult and sufficient testing could not be done. However, the following section provides an insight on the potential of the device, with the little data that was gathered. This shows the functionality of the device and capability of predicting the presence of clots. Further testing would allow for a through validation.

Upon testing on just a couple local subjects, mostly for the confirmation of the device functionality, the following trends were found.

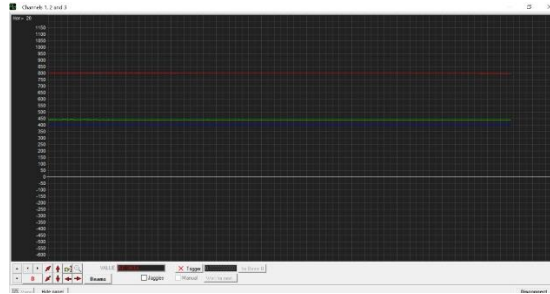
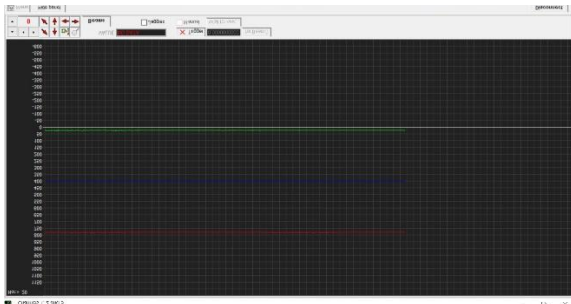

Figure 5: First preliminary test

Red line: Oscilloscope reference  
Green Line: Signal from right leg  
Blue Line: Signal from left leg

In this test (Figure 5), the signals from the left leg and the right leg are fairly close together, indicating that there is no clot present. This can be inferred as the absorbance of the IR light is nearly equivalent in both legs, meaning that they both don't have a clot present. This cannot be assumed as an indication of a clot being present in both legs due to the subtractive algorithm implemented.



**Figure 6:** Second preliminary test  
Red line: Oscilloscope reference  
Green Line: Signal from right leg  
Blue Line: Signal from left leg

This test (Figure 6) shows an indication of a clot being present in the left leg, as the absorbance of IR between both legs is drastically different. The blue signal from the left leg is not close to zero indicating a clot being present in the left leg, because subtractive algorithm shows the difference of absorbance. Hence, the closer the signal to the value 0 the lesser the chances of a clot being present, and the closer to 1 the greater the risk of a clot being present. This result seems consistent with prior data, as 80% of DVT clots occur in the left calf.

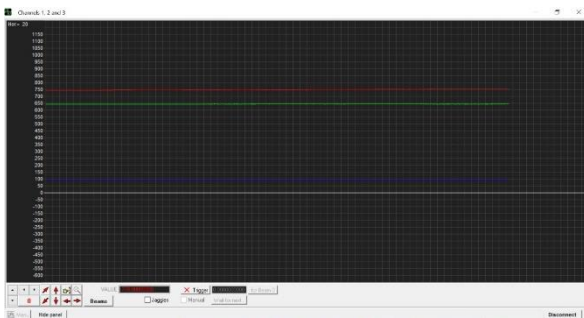

**Figure 7:** Third preliminary test  
Red line: Oscilloscope reference  
Green Line: Signal from right leg  
Blue Line: Signal from left leg

This test (Figure 7) made an interesting revelation. As seen, the lines are not close together, already an indication of the possibility of a clot being present. However, the green signal from the right leg is further from 0, suggesting that perhaps there

might be a clot present in the right leg, and as the blue signal from the left leg is closer to 0, it might not necessarily imply the absence of a clot. The blue signal is still not quantified as close to zero as compared to the previous test, which might show the early signs of clot formation. This might be due to human error during testing, but if simply the results are considered, they offer an insight in the potential of the device.

After constructing a low-cost portable device for DVT detection, data was accumulated from localized testing of the device. Due to the unpredictable COVID-19 global pandemic, further testing on a larger scale for effective validation was deemed unfeasible at the time. From the data collected, the device functionality in clot absent patients and clot present patients, which gives the implication that it would have continued giving prominent results.

The advantageous aspects of this project were that they it was very low cost, with an approximate cost of \$40. Compared to the current diagnostic instrumentation and diagnostic costs of thousands of dollars, this is a fraction of the cost. The current technologies available for DVT diagnosis are bulky and large, this device is merely a few hundred grams, which is easily portable. This portability and reduced cost can have greater implication on the health care system as a whole, giving it the possibility to reach remote tertiary healthcare centers where such testing is not only expensive, but usually impossible.

The disadvantage of this study has been the obvious lack of testing. As the circumstances were not preventable, it's very difficult to validate the efficacy of IR in detecting DVT on the basis of few results. This could be improved by contacting local hospitals with ethical permission, and gaining access to pregnant mothers, especially those with diagnosed DVT. Another disadvantage was that since the display has not yet been implemented into the hardware, a serial oscilloscope had to be utilized for display purposes. This made it difficult to utilize the probes without moving the serial oscilloscope and vice versa. This can be fixed by utilizing longer wires or utilization a Bluetooth system, once the device is validated.

Since one reading from a patient with diagnosed DVT was collected, it helped to prove the efficiency of the device, as the results were significantly different from those of local subjects without DVT. Continued testing is required to amount for mass data and analysis and prove efficacy of IR in detecting DVT.

#### 4. CONCLUSION

The device is currently in early stages of testing. Having been able to conduct 3 standardizing tests, it is clear that the device clearly gives clear differences between  $[HbO_2]$  and  $[Hb]$ . The comparative differences in the reading show the possibility of a clot being present in the leg, in contrast to healthy limbs. Since the Hb levels will be different from very early stages of clot formation, this device will allow for early diagnosis, once through testing is done to further standardize values and prove efficacy. In the case the IR proves to have high efficacy, it will allow for a low cost, portable, early diagnostic device, which

operates on low power and can be utilized in clinics and hospitals without the need for highly trained personnel. This would permit for a call to action of regular testing for DVT during gestational appointments.

### ACKNOWLEDGEMENTS

I would like to express my sincere gratitude to Mr. Venkatesh Vijaykumar and Ms. Abhilasha Jain for providing me with hardware suggestions and insight towards the electronics part of the project. Their help in teaching me software aspects of the project greatly aided in progressing the project.

### REFERENCES

- [1] M. Sousa Gomes, M. Guimarães, and N. Montenegro, "Thrombolysis in pregnancy: a literature review," *Journal of Maternal-Fetal and Neonatal Medicine*, vol. 32, no. 14. Taylor and Francis Ltd, pp. 2418–2428, Jul. 18, 2019, doi: 10.1080/14767058.2018.1434141.
- [2] V. T. Ho, A. Dua, K. Lavingia, K. Rothenberg, C. Rao, and S. S. Desai, "Thrombolysis for Venous Thromboembolism During Pregnancy: A Literature

Review," *Vascular and Endovascular Surgery*, vol. 52, no. 7. SAGE Publications Inc., pp. 527–534, Oct. 01, 2018, doi: 10.1177/1538574418777822.

- [3] C. Tovey and S. Wyatt, "Diagnosis, investigation, and management of deep vein thrombosis," *British Medical Journal*, vol. 326, no. 7400. pp. 1180–1184, May 31, 2003.
- [4] "Thromboembolic Disease in Pregnancy and the Puerperium: Acute Management Green-top Guideline No. 37b," 2015.
- [5] M. W. Hemelt, J. T. Barnett, D. F. Bruley, and K. A. Kang, "Application of Near-IR Time-Resolved Spectroscopy and Frequency Response Analysis for Deep Vein Thrombosis Detection," pp. 640–648, 1997.
- [6] T. Li, Y. Sun, X. Chen, Y. Zhao, and R. Ren, "Noninvasive diagnosis and therapeutic effect evaluation of deep vein thrombosis in clinics by near-infrared spectroscopy," *J. Biomed. Opt.*, vol. 20, no. 1, p. 010502, Jan. 2015, doi: 10.1117/1.jbo.20.1.010502.