



The Society shall not be responsible for statements or opinions advanced in papers or discussion at meetings of the Society or of its Divisions or Sections, or printed in its publications. Discussion is printed only if the paper is published in an ASME Journal. Authorization to photocopy material for internal or personal use under circumstance not falling within the fair use provisions of the Copyright Act is granted by ASME to libraries and other users registered with the Copyright Clearance Center (CCC) Transactional Reporting Service provided that the base fee of \$0.30 per page is paid directly to the CCC, 27 Congress Street, Salem MA 01970. Requests for special permission or bulk reproduction should be addressed to the ASME Technical Publishing Department.

Copyright © 1997 by ASME

All Rights Reserved

Printed in U.S.A.



## FOIL AIR/GAS BEARING TECHNOLOGY ~ AN OVERVIEW

Giri L. Agrawal  
R&D Dynamics Corporation  
Bloomfield, CT 06002

### ABSTRACT

This paper summarizes the chronological progress of foil air bearings for turbomachinery during the last 25 years. Descriptions of various machines which are in production are provided. The foil bearing air cycle machine on the 747 aircraft has demonstrated an MTBF (mean time between failure) in excess of 100,000 hours. Many advantages of foil air bearings are noted. Various designs of foil air bearings presently in use and their relative merits are described. Analytical methods, their limitations, and their relationships with test results are noted. Descriptions of various machines built and tested in process fluids being gases, other than air, and cryogenic liquids are described. Conclusions are drawn that various high speed turbomachines including high temperature applications can be designed and developed using foil air bearings which will increase efficiency and reduce cost of these machines.

### INTRODUCTION

Foil air bearings have made significant progress during the last 25 years. Reliability of many high speed turbomachines with foil bearings has increased over tenfold compared to those with rolling element bearings. A high speed rotating machine called Air Cycle Machine (ACM) is the heart of the Environmental Control System (ECS) used on aircraft to manage cooling, heating and pressurization of the aircraft. Today, ACM for almost every new ECS system on military and civil aircraft and on many ground vehicles use foil air bearings. Old ECS systems with rolling element bearings are being converted to foil air bearings. The F-16 aircraft ACM used rolling element bearings from 1974 to 1982, but all aircraft built since 1982 use foil air bearings. The 747 aircraft ACM used rolling element bearings from 1970 to 1988. All aircraft

built since 1988 have foil air bearings. ECS on the older model 737 aircraft have rolling element bearings, whereas ECS on new 737 use foil air bearings. Many machines with working fluids other than air, such as helium, xenon, refrigerants, liquid oxygen and liquid nitrogen, have been built and successfully tested.

### WHY FOIL BEARINGS?

The use of foil bearings in turbomachinery has several advantages.

**Higher Reliability** - Foil bearing machines are more reliable because there are fewer parts necessary to support the rotative assembly and there is no lubrication needed to feed the system. When the machine is in operation, the air/gas film between the bearing and the shaft protects the bearing foils from wear. The bearing surface is in contact with the shaft only when the machine starts and stops. During this time, a coating on the foils limits the wear.

**No Scheduled Maintenance** - Since there is no oil lubrication system in machines that use foil bearings, there is never a need to check and replace the lubricant. This results in lower operating costs.

**Soft Failure** - Because of the low clearances and tolerances inherent in foil bearing design and assembly, if a bearing failure does occur, the bearing foils restrain the shaft assembly from excessive movement. As a result, the damage is most often confined to the bearings and shaft surfaces. The shaft may be used as is or can be repaired. Damage to the other hardware, if any, is minimal and repairable during overhaul.

**Environmental Durability** - Foil bearings can handle severe environmental conditions such as sand and dust ingestion. Larger particles do not enter into the bearing flow path because of a reversed pitot design at the cooling flow inlet and smaller particles are continually flushed out of the bearings by the cooling flow. This ability to withstand contamination eliminates the need for filters in the airflow.

**High Speed Operation** - Compressor and turbine rotors have better aerodynamic efficiency at higher speeds. Foil bearings allow these machines to operate at the higher speeds without any limitation as with ball bearings. In fact, due to the hydrodynamic action, they have a higher load capacity as the speed increases.

**Low and High Temperature Capabilities** - Many oil lubricants cannot operate at very high temperatures without breaking down. At low temperature, oil lubricants can become too viscous to operate effectively. Foil bearings, however, operate efficiently at severely high temperatures, as well as at cryogenic temperatures.

**Process Fluid Operations** - Foil bearings have been operated in process fluids other than air such as helium, xenon, refrigerants, liquid oxygen and liquid nitrogen. For applications in vapor cycles, the refrigerant can be used to cool and support the foil bearings without the need for oil lubricants that can contaminate the system and reduce efficiency.

## HISTORY

Garrett AiResearch (now Allied Signal) has done the pioneering work on foil air bearings. Several laboratory and prototype machines were built in the mid 60's. The first production ACM using foil air bearings was designed and developed for the DC-10 ECS system in 1969. Field experience proved that the unit was far more reliable than previous 727 ball bearing units. Further research and laboratory testing to increase load capacity and damping continued. In 1972, a 125 kw turbo-alternator-compressor (TAC) supported on foil bearings was built by AiResearch for NASA Lewis, which worked well. In 1974, under pressure from the Navy to increase the reliability of the A7E air cycle machine, AiResearch converted existing ball bearing machines to foil bearing machines on three A7E aircraft. These aircraft were flown by the Navy off the Coral Sea during the Vietnam War for evacuation of Americans from South Vietnam. These units worked extremely well and proved to be much more reliable than previous ball bearing units. As a result, after Vietnam was over, the Navy gave a contract to AiResearch to convert the entire fleet of A7E to foil bearing units. This program gave high confidence to AiResearch management in foil bearing technology even for a military aircraft. In 1976, when the F-18 program was launched by Northrop, AiResearch decided to proceed with foil air bearings from the start. The unit successfully passed vibration and shock load testing. This was the first military unit with foil air bearings to go into production.

In 1978, AiResearch developed a small foil air bearing supported ACM for the commuter plane Cessna-550. This unit since then is also used on other aircraft e.g. EMB-120, ATR-42, ATR-72 and others. In 1979, a new commercial aircraft 767/757 was launched by Boeing. By now the success of foil air bearings

was well known; hence Boeing required that ECS on 767/757 use foil air bearings. AiResearch successfully developed a foil air bearing supported ACM for 767/757. Based on the successful testing, they won the contract and went into production. In 1979 AiResearch developed a foil air bearings supported ACM for Navy F-14 aircraft which was also flight tested on Air Force F-15 aircraft with some modifications. Later AiResearch, by making necessary modifications, used existing machines on various other ECS systems. They also developed a small foil air bearing supported machine for the M-1 tank.

While substantial advancement in foil air bearing technology was being made by AiResearch in the 70's, their competitor Hamilton Standard started lagging behind in ECS business. At the same time, Mechanical Technology Inc. (MTI), a research and development company, came up with their own concept of a foil bearing design called Hydresil. Hamilton signed a contract with MTI to use Hydresil bearings. Hydresil had comparable load capacity, but had low damping. Several ACM with Hydresil bearings were flight tested by Hamilton on 747 aircraft from 1975 to 1979. During flight testing those units lasted only four hours to fifty hours. In 1979, Hamilton launched their own program for foil bearing research. They came up with their own design concept and patented it. In 1982, Hamilton successfully flight tested a foil bearing ACM based on their own foil bearing design on F-16 aircraft. The same machine with minor changes went into production for B-1B aircraft and B-2 aircraft. Later the same machine was successfully flight tested on two F-18 aircraft. Based on successful flight test experience, the Navy qualified the machine for the F-18 without formal qualification testing. Hamilton also developed, qualified and produced a machine for L-1011 aircraft. Under pressure from various airlines, Boeing adopted the same machine with some changes for 747-400 aircraft which went into production in 1988. This machine has shown MTBF (mean time between failure) of over 100,000 hours. Between 1983 and 1988, Hamilton developed several other prototype machines supported on foil air bearings. In 1991, Hamilton developed, qualified and started producing a machine for SAAB 2000 aircraft. The same machine is being used for EMB-145 aircraft.

In 1993, Hamilton developed, qualified and started producing the world's first four-wheel ACM supported on foil air bearings for 777 aircraft. The unit passed 36,000 start-stop cycle to simulate a 30 year life.

Various other companies such as Sunstrand, British Aerospace, ABG-Semca (France) and Tupolev (Russia) have done limited work on foil air bearing technology.

## FOIL BEARING TECHNOLOGY

The principle of an air or gas bearing is simple. As shown in Fig. 1, when two surfaces form a wedge, and one surface moves relative to the other surface, pressure is generated between the surfaces due to the hydrodynamic action of the fluid which carries load.

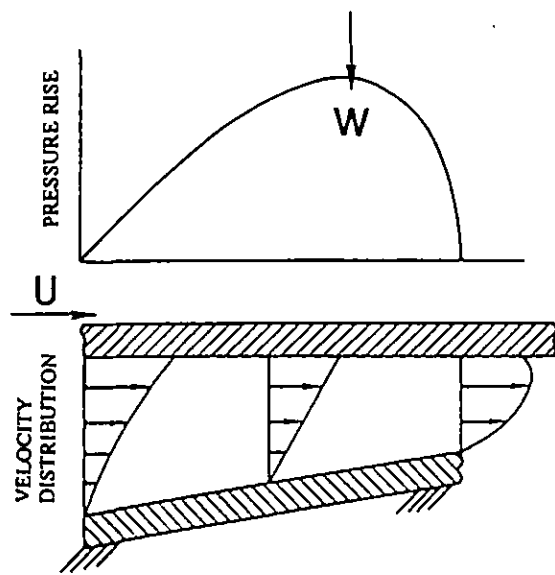


Fig. 1: Principle of an Air Bearing

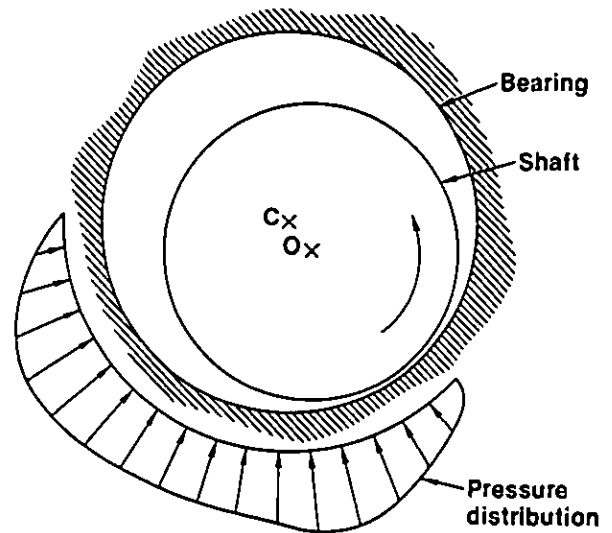


Fig. 2: Hydrodynamic Pressure Generation

#### Journal Bearing

In a journal bearing, the shaft deflects and a wedge is formed due to the eccentricity between the shaft center and the bearing center. The resulting hydrodynamic pressure generation is shown in Fig. 2. Even though, the principle of an air bearing is simple, application is complex. Usually running radial clearance between the shaft and the bearing is less than 0.0005 inch for a 2 inch diameter shaft running at 36,000 rpm. But the shaft growth due to temperature and centrifugal force could be 0.0020 in. Hence a bearing can not be made to work at various speeds and temperatures. In addition, damping is required to suppress any whirl instability, and there could be misalignment between various rotating parts and stationary parts. These problems are resolved by foil bearings. While stationary, there is a small amount of preload between the shaft and the bearing. As the shaft turns, a hydrodynamic pressure is generated, which pushes the foils away from the shaft and the shaft becomes completely airborne. This phenomenon occurs instantly during start-up at a very low speed. When the shaft is airborne, friction loss due to shaft rotation is very small. As the shaft grows, the foils get pushed further away keeping the film clearance relatively constant. In addition, foils provide coulomb damping due to relative sliding, which is essential for stability of the machine. Various concepts of foil bearings have been tested.

The Multipad concept is shown in Fig. 3, which has been pursued by AiResearch since the days of the DC-10. Multiple pads form an iris and provide a preload when the shaft is not running. During starting, the iris expands and a cushion of air is formed between the bearing and the shaft. Later versions such as for 767/757 have a supportive spring behind each pad which increases the load capacity significantly. The top foil is coated with Teflon-S or a polyimide coating to provide lubricity during starts and stops.

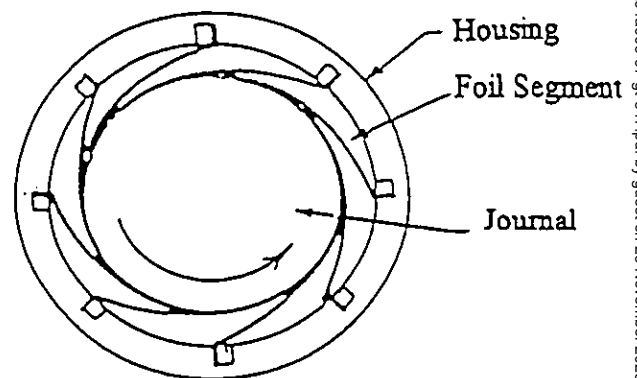
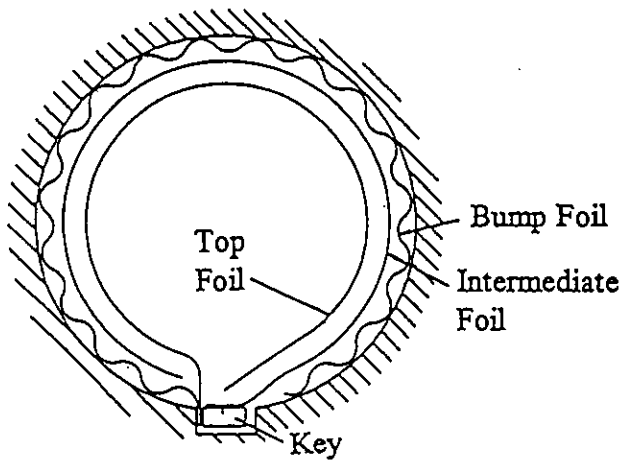


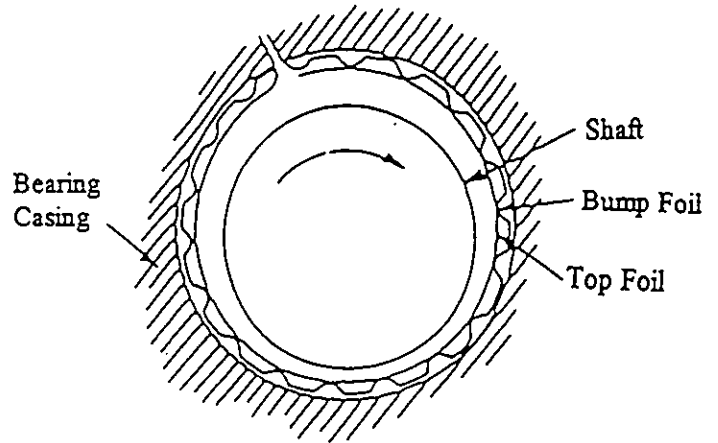
Fig. 3: Multipad Foil Journal Bearing Schematic

Figure 4 is a Reversed Multilayer journal bearing concept which has been pursued by Hamilton Standard in 747, B-1B, B-2, SAAB-2000, 777 and other aircraft. The single corrugated (bump) foil which has a bilinear spring characteristic is restrained in an axial keyway in the outer shell along one edge. The intermediate and top foils are attached to a key along one edge and are wound in opposite directions. The top foil has a thin coating which provides lubricity during startup and shutdown. As the shaft rotates, a wedge is formed due to the radial displacements of the shaft. Hydrodynamic action draws the working gas into the wedge where it is locally compressed. The corrugated foil acts as a spring which accommodates expansion, excursions and any misalignment. It also provides a flow path for the cooling air to remove parasitic heat from the bearing. In the Reversed Multilayer foil bearing, the adjacent foils move in opposite directions. The net result is that relative movement is additive, which in turn produces high coulomb damping.



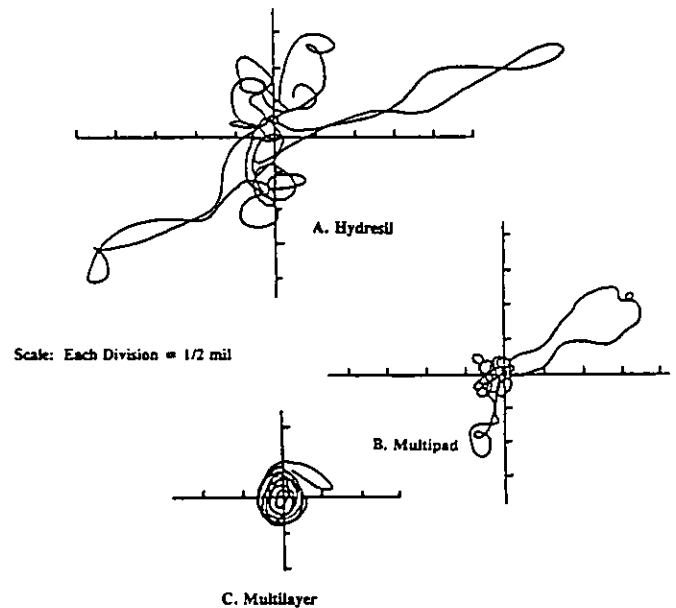
**Fig. 4: Reversed Multilayer Foil Journal Bearing Schematic**

Figure 5 is a Hydresil foil journal bearing. It has been pursued by Mechanical Technology Inc. (MTI). Both the bump foil and the foil are spot welded to the sleeve. Various versions have been patented. The load capacity of the Hydresil is comparable to the Multipad or Reversed Multilayer foil bearing, but it has low damping.



**Fig. 5: Hydresil Foil Journal Bearing Schematic**

The damping characteristic of three types of bearings is shown in Fig. 6, where orbits are shown when 27 lbs. of shock load is applied to a 2 inch diameter shaft rotating at 36,000 rpm. It is obvious that the Reversed Multilayer concept is the most stable and it is least affected by shock loads.



**Fig. 6: Orbits of Various Foil Journal Bearings under 27 lbs. of Shock Load**

Even though Reversed Multilayer concept has high damping, the foils have a tendency to protrude like a telescope during assembly. In addition, manufacturing is costly because all bends near the keyway have tight tolerances. A new concept called Reversed Multipad shown in Fig. 7 has been patented by R&D Dynamics Corporation. It has benefits of both Multipad and Reversed Multilayer designs. It has high damping as well as it requires low preload. Lower preload makes the machine start at a lower torque. Due to multipad design, the tolerances are not tight.

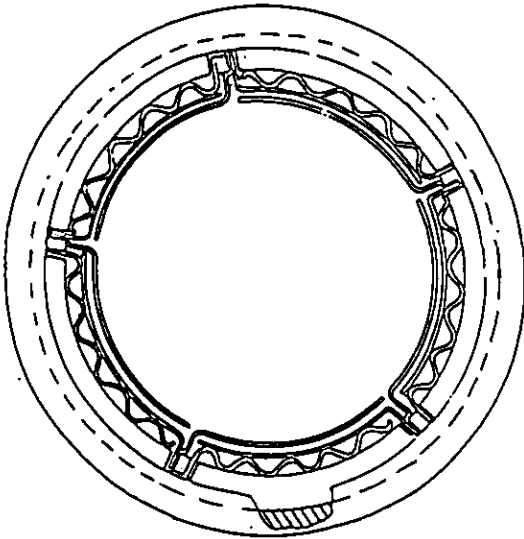


Fig. 7: Reversed Multipad Foil Journal Bearing Schematic

### Thrust Bearings

Thrust bearings withstand axial loads in a rotating machinery. They work on the same hydrodynamic principle as journal bearings shown in Fig. 1. In a journal bearing the wedge action comes from eccentricity between the center of the rotating shaft and the center of the bearing itself, whereas in a thrust bearing the wedge is built in taking into account any deflection due the axial load.

A radial spring type thrust bearing is shown in Fig. 8. It was invented by AiResearch and has been followed since 1970 when first used for the DC-10. There are multiple radial springs which transfer the load to the housing. Foils between the springs deflect under pressure forming the wedge required for the hydrodynamic action. During the last 20 years many versions of the same design, usually for the manufacturing reasons mostly by AiResearch, have been used. In some designs instead of a separate spring being spot welded to the main bearing plate, it is formed by chemical etching out of the bearing plate. It reduces manufacturing cost, but somewhat compromises performance in some instances.

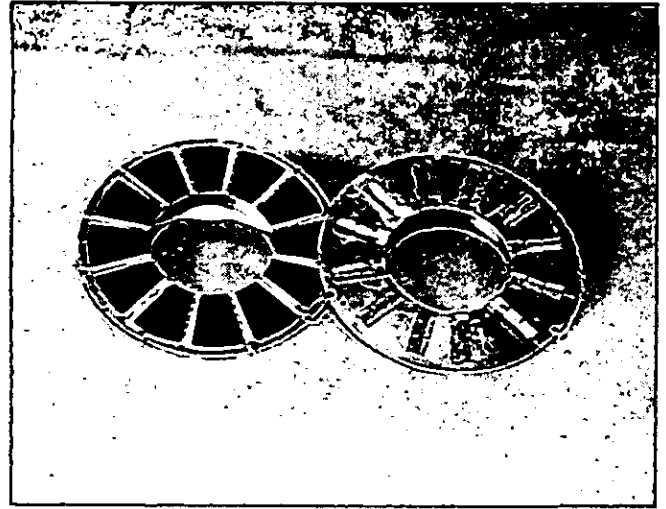


Fig. 8: Radial Spring Foil Thrust Bearing

A dual spring thrust bearing is shown in Fig. 9. It was invented by Hamilton Standard. In this concept the bearing consists of two washer shaped plates similar to radial spring bearings. The coated pads, welded to the top plate, are supported on stiff bump foil springs to optimize the wedge shape required for load capacity and lift-off. The bottom plate has several softer bump foil springs welded to it, required to optimize the overall spring rate and damping of the bearing. The dual spring rate thrust bearings have approximately 15% higher load capacity than the radial spring bearings, but they are more expensive to manufacture.

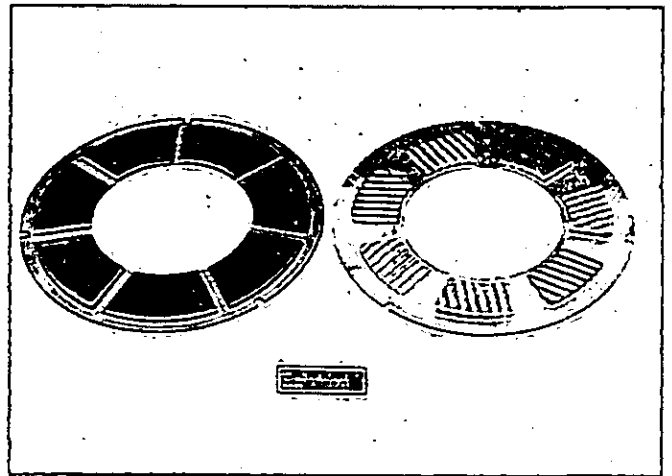


Fig. 9: Dual Spring Foil Thrust Bearing

### Coatings

Both journal and thrust bearings apply a small amount of preload on the shaft when the machine is not running. The foil face which is touching the shaft is coated for lubricity during startup and shutdown. A typical DC-10, machine which runs at 48,000 rpm, is fully airborne at about 2,000 rpm. Several foil coatings are used. Most commercial aircraft use Teflon-S made by DuPont which is

good up to 475°F. Most military aircraft ACM use a polyimide coating, whose basic research was performed by NASA Lewis. Both AiResearch and Hamilton have modified the basic formula and the application process to suit their needs. The coating is good up to 700°F. Extensive high temperature coating research has been performed, mostly by NASA Lewis, Air Force Wright Laboratory, AiResearch (Phoenix Division) and Mechanical Technology Inc. A partial list of various coatings, which have been considered, is given below:

Coating	Process
<b>FOIL:</b>	
BN/Pt, BN/Pd	Electrophoretic Deposition
BN/Pt	Chemical Vapor Infiltration
BN/SiO <sub>2</sub> , BN/ZrO <sub>2</sub>	Sol Gel
BN/Ni-Cr, ZrO <sub>2</sub> /Ni-Cr	Mechanical Alloying
BN/Ni	Electroless Deposition
Cr <sub>2</sub> O <sub>3</sub>	Sputtering
TiC	Sputtering
Al <sub>2</sub> O <sub>3</sub>	Sputtering
TiN	Sputtering
Tribaloy-400	Sputtering
<b>JOURNAL:</b>	
NASA PS212	Plasma Spray
KAMAN DES	Chemically Adherent
TiAlN/TiAl	Sputtering
WC-9Co	D-Gun
Cr <sub>2</sub> O <sub>3</sub> -4OCr	D-Gun

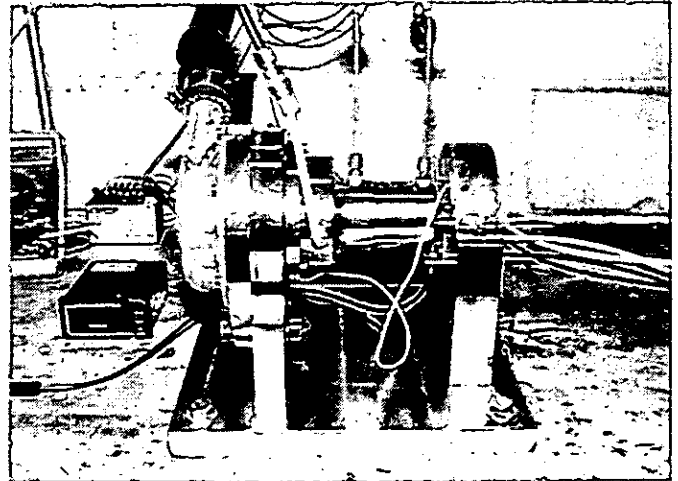
**Analysis and Testing**

The analysis of foil air bearings requires simultaneous solutions or iteration methods to solve foil elasticity equations and fluid hydrodynamic equations. Foil elasticity equations are nonlinear and involves large deformation theory. A foil can deform as much as five times its own thickness. Hence most finite element or finite difference methods, do not provide satisfactory results. Hydrodynamic equations are nonlinear Reynolds' equations with continuously changing boundary conditions. Many papers analyzing foil bearings have been published. In some papers, predicted results vary as much as 500% from the actual test results. What seems to work and provide reasonable results are semi-empirical methods. Sufficient test data are collected by varying geometrical parameters and test parameters of the bearing. Results are correlated using a multiple regression method. Then a model is prepared using coefficients of the multiple regression analysis. Hydrodynamic equations are solved using the preferred final geometry. Then an inverse method is used to design the foil geometry in the unloaded position. In the above described procedure, the complex problem is decoupled into many simple problems using both analytical methods and the test results.

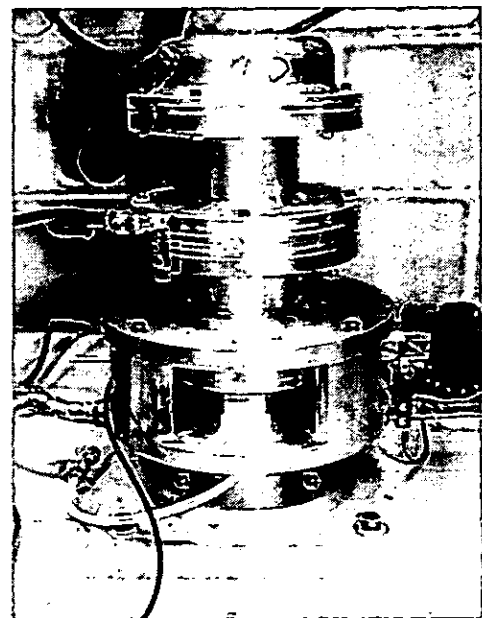
The above described approach has been used both by AiResearch (Los Angeles) and Hamilton Standard to design and develop successfully many foil air bearing machines which are flying today. Others have taken more conventional approach and have not succeeded. Design of the machine parameters such as static and dynamic loads, critical speed, thrust loads, rotor

clearance, seals, cooling flow etc. must be correlated with the design of the foil air bearings.

A satisfactory design method requires reliable test data. Successful test rigs to test journal bearings, thrust bearings and coatings have been designed and developed. Typical rigs presently being used at R&D Dynamics Corporation are shown in Figs. 10, 11 and 12.



**Fig. 10: Journal Bearing Test Rig (R&D Dynamics Corp.)**



**Fig. 11: Thrust Bearing Test Rig (R&D Dynamics Corp.)**

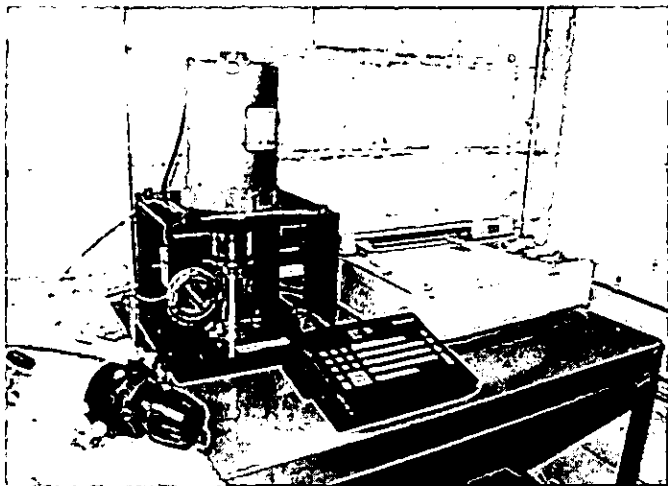


Fig. 12: Coating Wear Test Rig  
(R&D Dynamics Corp.)

#### APPLICATIONS

**DC-10** - The DC-10 was the first production foil air bearing machine. It was designed and developed by AiResearch and went into production in 1970. The same machine is also used for Airbus A-300. A photograph of the machine is shown in Fig. 13. The rotating assembly has three rotors: a turbine, a compressor and a fan. The machine runs at 48,000 rpm. To date, over 80 million hours have been accumulated on this machine.

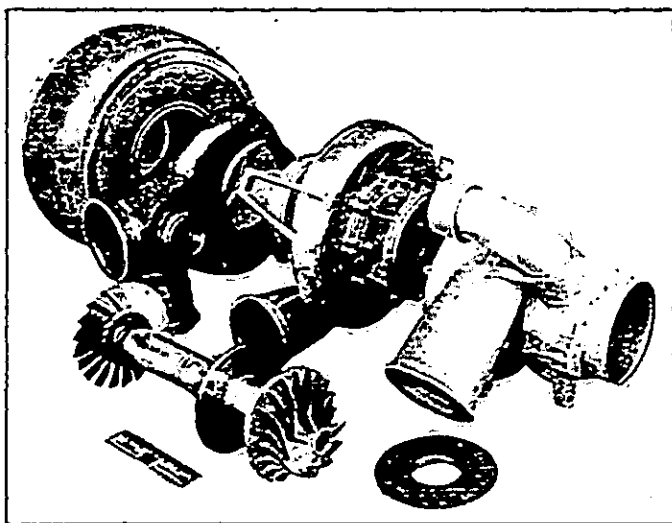


Fig. 13: DC-10 Foil Bearing Air Cycle Machine  
(Developed by AiResearch)

**F-18** - The F-18 is the first military production machine after successful modifications of the A7E machine from ball bearings to air bearings. The F-18 machine was designed and developed by AiResearch in 1976. A cross section of the machine is shown in Fig. 14. It has two rotors: a turbine and a compressor. The machine runs at about 95,000 rpm.

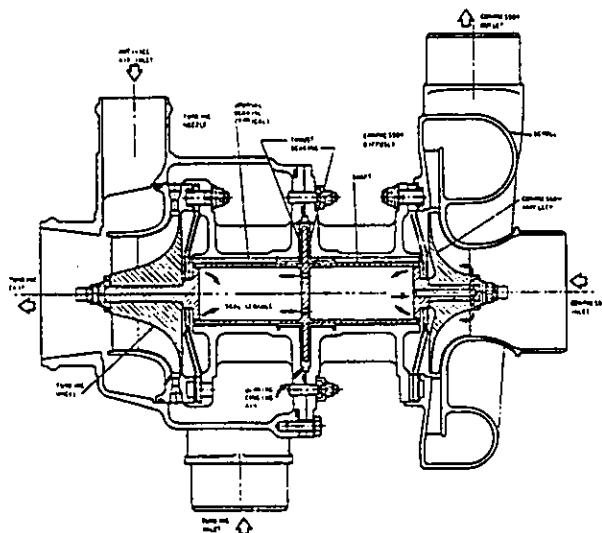


Fig. 14: F-18 Foil Bearing Air Cycle Machine  
(Developed by AiResearch)

**Cessna-550** - In 1977 AiResearch developed a small two-wheel air cycle machine for commuter aircraft such as the Cessna-550. The machine is shown in Fig. 15. It runs at 105,000 rpm. The same machine is being used for EMB-120, ATR-42 and ATR-72 aircraft with minor modifications.

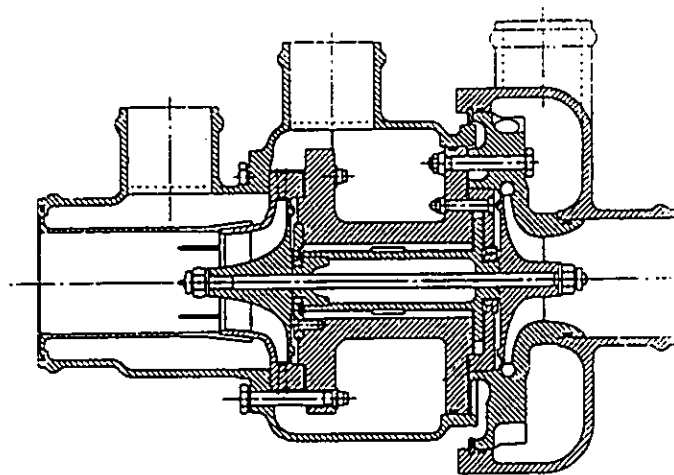
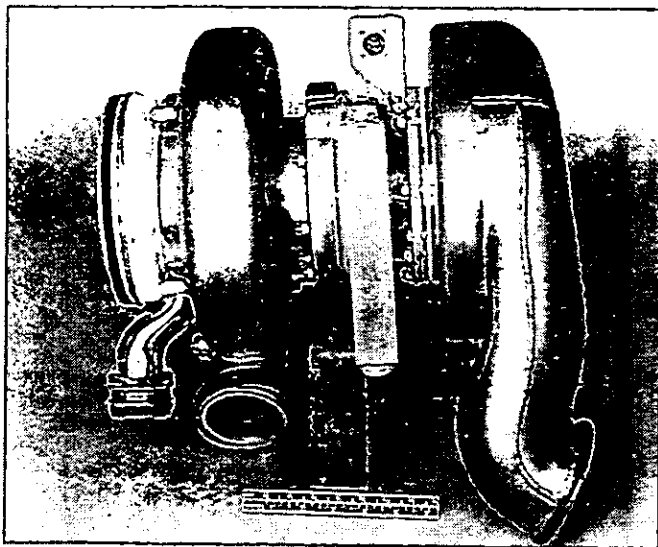


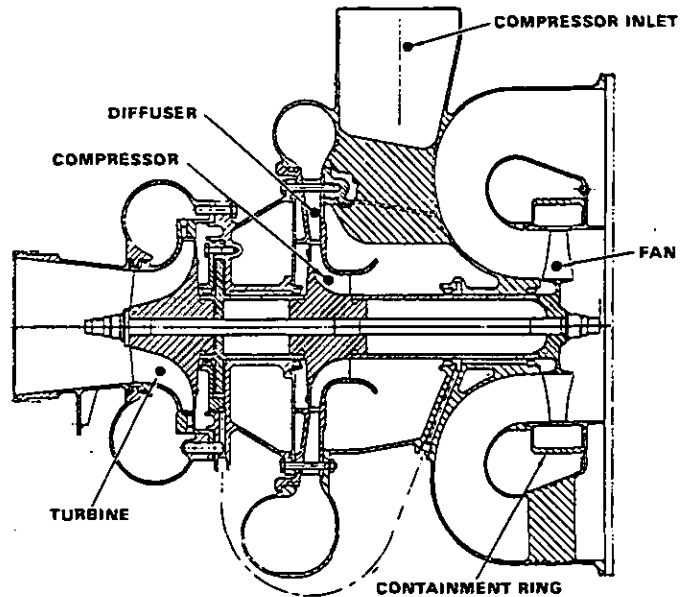
Fig. 15: Cessna-550 Foil Bearing Air Cycle Machine  
(Developed by AiResearch)

**F-15/F-14** - Following success of the F-18, AiResearch developed a slightly larger two-wheel air cycle machine for F-15 aircraft in 1977. The same machine with slight modifications was used for F-14 aircraft in 1978. Photograph of F-14 machine is shown in Fig. 16.



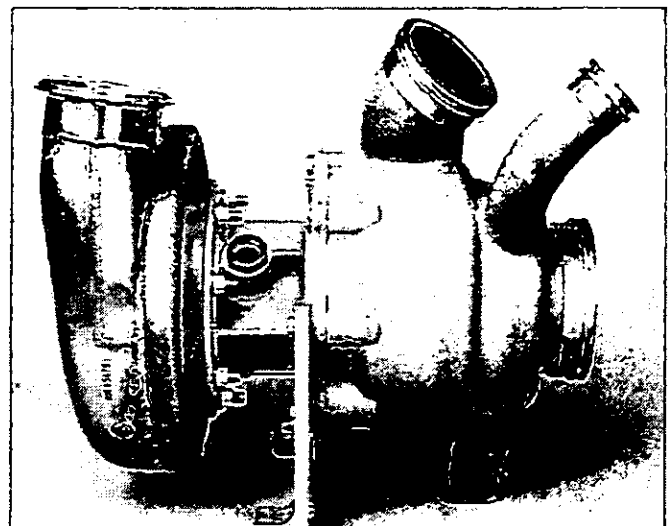
**Fig. 16: F-14 Foil Bearing Air Cycle Machine**  
(Developed by AiResearch)

**767/757** - The 767/757 aircraft was launched by Boeing in 1979. Knowing the success of DC-10 ACM, Boeing required that 767/757 ACM must have foil air bearings. This was the first aircraft where the customer required a foil bearing ACM. Cross section of the machine developed by AiResearch is shown in Fig. 17. It is also a three-wheel machine like the DC-10, but the design is much simpler.



**Fig. 17: 767/757 Foil Bearing Air Cycle Machine**  
(Developed by AiResearch)

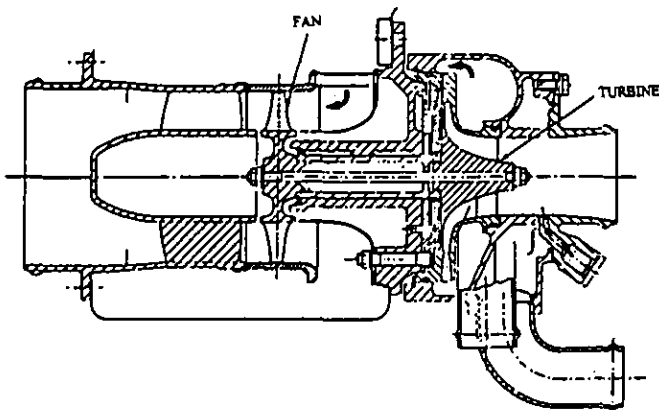
**F-16** - The F-16 aircraft is built by General Dynamics. Its production was started in 1974. An air cycle machine with a ball bearing design was built by Hamilton Standard. In 1982, due to additional electronics on the aircraft, the Air Force required a new air cycle machine. AiResearch modified the existing F-18 machine and qualified for F-16 aircraft, which is now in production. A photo of the F-16 ACM is shown in Fig. 18.



**Fig. 18: F-16 Foil Bearing Air Cycle Machine**  
(Developed by AiResearch)

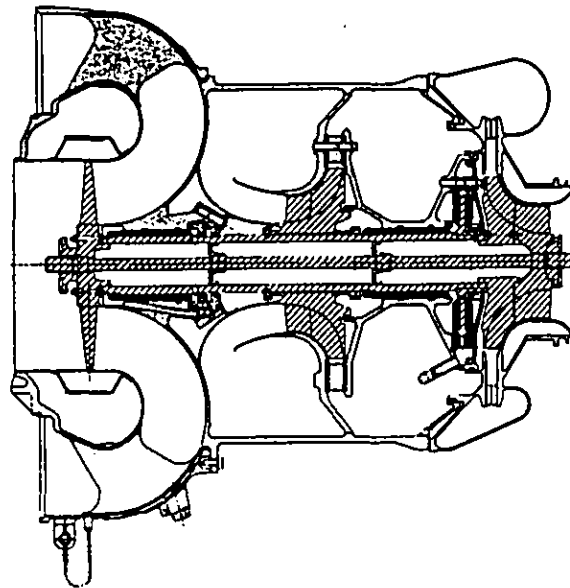


**M1A1** - AiResearch also developed a foil air bearing air cycle machine for the M1A1 tank environmental control system. The machine has a turbine and a fan on a common shaft. The machine worked well during the last Gulf War in spite of heavy sand and dust in the desert. The machine is shown in Fig. 19.

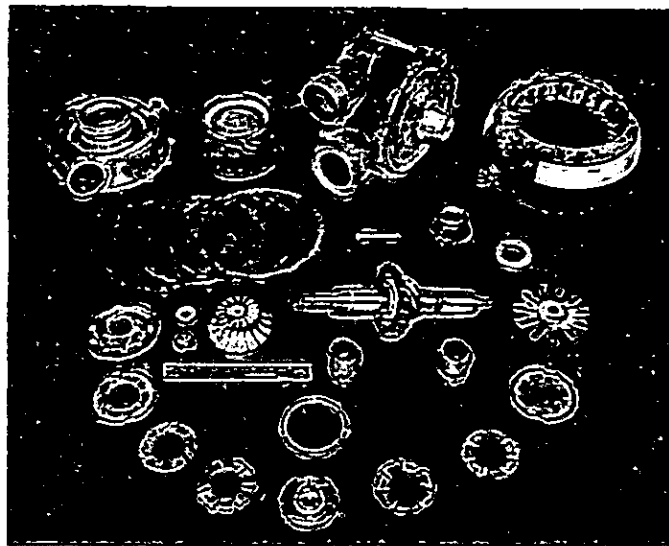


**Fig. 19: M1A1 Tank Foil Bearing Air Cycle Machine**  
(Developed by AiResearch)

**L-1011** - The L-1011 machine was the first production foil bearing machine produced by Hamilton Standard. As can be seen in Fig. 20, it is a three-wheel machine with fan, compressor and turbine rotors. These ACMs were placed on the last five production L-1011 aircraft and have been performing well. Figure 21 shows an L-1011 flight test unit that was returned for inspection after 13,000 hours of service at Saudia. The unit was in excellent working condition despite being heavily contaminated by sand, cement and oil. This shows the ability of the foil bearings to operate in severe environmental conditions.

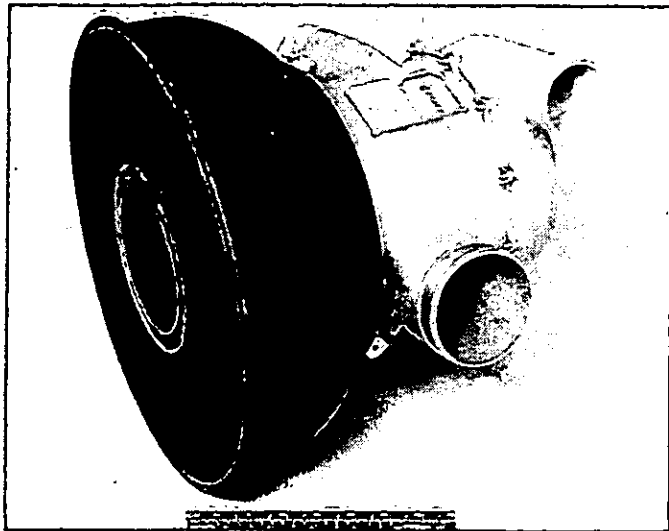


**Fig. 20: L-1011 Foil Bearing Air Cycle Machine**  
(Developed by Hamilton Standard)



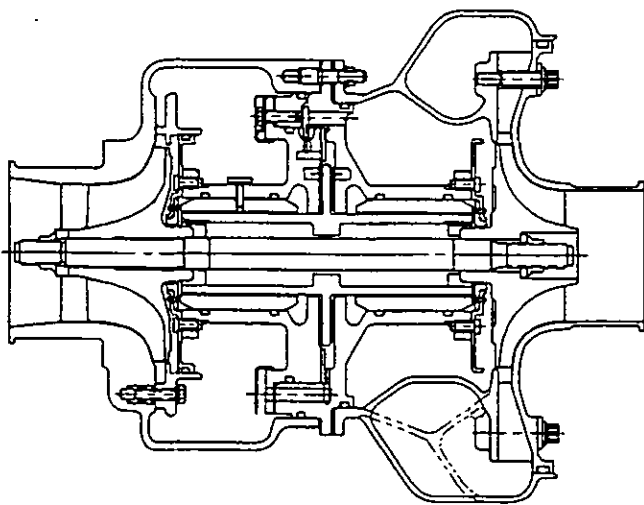
**Fig. 21: L-1011 Foil Bearing Air Cycle Machine**  
After 13,000 Hours in Saudia Aircraft

**747** - Hamilton Standard supplies the ECS on the 747 aircraft. Aircraft production started in 1970. Air cycle machines on all aircraft built until 1987 are ball bearing units. Under pressure from the airlines, Boeing and Hamilton Standard decided to change the ECS system to incorporate foil air bearing ACMs. All 747 aircraft built since 1988 have foil bearing ACMs. Over 1000 machines are flying successfully. These machines are performing well in the field, and to date, over 12 million flight hours have been accumulated. The machine has shown an MTBF (mean time between failure) of over 100,000 hours in the field. A photograph of the 747 machine is shown in Fig. 22.



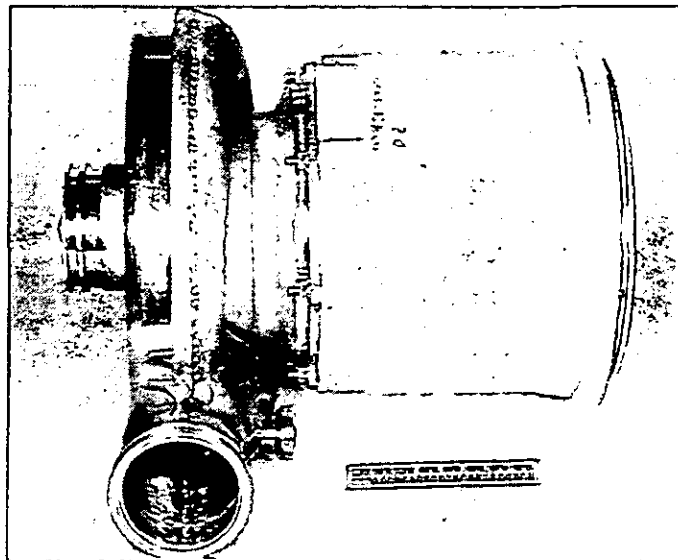
**Fig. 22: 747 Foil Bearing Air Cycle Machine**  
(Developed by Hamilton Standard)

**B-1B** - The foil bearing machine shown in Fig. 23 was developed for use on the B-1B aircraft by Hamilton Standard. The unit runs at 95,000 rpm. To date, this two-wheel foil bearing machine has logged over 120,000 flight hours. One hundred production units and thirty spares were delivered for use on this long range bomber.

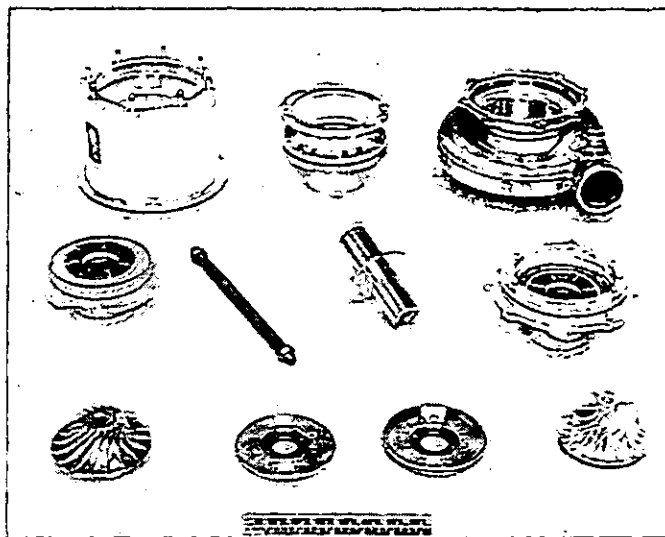


**Fig. 23: B-1B Foil Bearing Air Cycle Machine**  
(Developed by Hamilton Standard)

**B-2** - Hamilton Standard builds the ECS system on the Air Force B-2 Stealth bomber. The system contains a high speed foil bearing supported ACM. The B-2 ACM, shown in Fig. 24, completed a rigorous qualification program in 1989. After one test that included 7500 start/stop cycles, the bearings were inspected and found to be in like-new condition. The hardware for this machine is shown in Fig. 25. Another test included 1600 hours of endurance running. These tests show the durability of the foil bearings. Many B-2 aircraft are flying successfully using foil bearing ACMs.

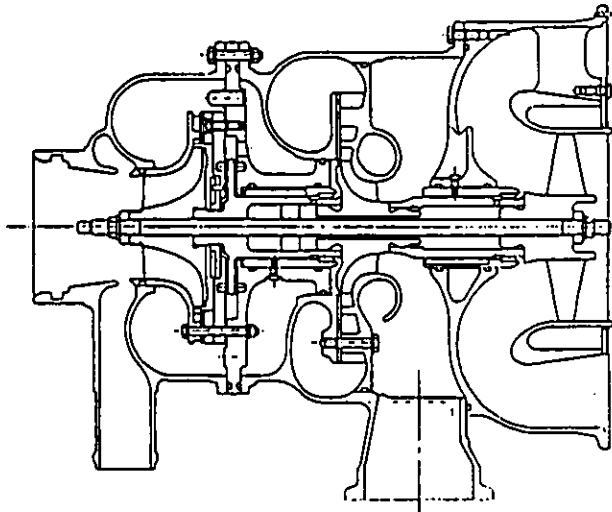


**Fig. 24: B-2 Foil Bearing Air Cycle Machine**  
(Developed by Hamilton Standard)



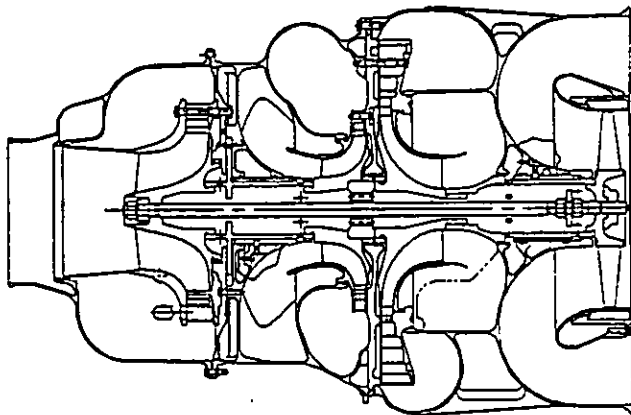
**Fig. 25: B-2 Foil Bearing Air Cycle Machine After 7,500 Start-Stops**

**SAAB-2000** - Hamilton Standard has designed, developed and qualified a midsize foil air bearing ACM for use on SAAB-2000 commuter aircraft. Many aircraft with these units are flying successfully. Shown in Fig. 26, this three-wheel machine will also be used on other large commuter aircraft.



**Fig. 26: SAAB-2000 Foil Bearing Air Cycle Machine**  
(Developed by Hamilton Standard)

**777** - Hamilton Standard has developed and qualified an ECS system on the latest Boeing aircraft 777. The system uses the world's first four-wheel air bearing ACM. All of the previous machines are either two-wheel or three-wheel machines. The unit has successfully passed 36,000 start-stop cycles, which is equivalent to 30 years life of the machines. Many 777 aircraft are flying with production ACMs. Approximately 300 aircraft have already been sold and will be delivered in the near future. A cross section of the ACM is shown in Fig. 27.



**Fig. 27: 777 Foil Bearing Air Cycle Machine**  
(Developed by Hamilton Standard)

## ADDITIONAL APPLICATIONS

Many applications of foil air/gas bearings other than air cycle machines have been built and successfully tested, but nothing appears to be in production at this time. AiResearch successfully tested a vapor cycle machine on Navy P-3 aircraft with Freon as the working fluid. A machine similar to this will be built for F-22 aircraft. A cryogenic foil bearing turbo pump working in liquid oxygen was built by AiResearch and successfully tested by NASA. Both AiResearch and Hamilton Standard have built foil bearing high speed fans for the Space Station. Several cryogenic foil bearing turboexpanders for air separation plants for the Navy have been built. AiResearch built a high temperature foil bearing APU (Auxiliary Power Unit) for B-2 aircraft in 1985. The unit ran successfully, but could not pass the endurance test. It was concluded that coating wear at high temperature was the cause. Since then much research has been done in the areas of foil coating and bearing design. Recently R&D Dynamics jointly with Allison Engine Company built a missile engine with a hot end foil bearing good up to 1000 °F.

## CONCLUSIONS

Foil bearings have been extremely successful for air cycle machines. They have increased the reliability of these machines up to tenfold. Even though several machines have been built for other applications, the work has not been pursued by the same vigor and commitment for various reasons. Foil bearings have strong potential for the following applications:

- A. A small general aviation gas turbine engine supported on foil bearings will be more reliable and cost less than existing engines.
- B. Oil free cryogenic turboexpanders supported on foil bearings will be more reliable and increase efficiency of gas separation plants.
- C. Highly reliable and less expensive APU's can be built for various aerospace and ground vehicles using foil bearings.
- D. Recent concept of foil bearings provide potential for low cost bearings using automated manufacturing methods for commercial applications; e.g. automobile gas turbine engines, vapor cycle centrifugal compressors and commercial air/gas compressors.

## ACKNOWLEDGMENTS

The materials presented here have been compiled from various sources including those from airlines and military customers. Some cross sections and photos were reproduced or redrawn from previously published material or sales brochures. Some photos were retaken from hardware available with various customers.