

CRISIS VENTILATOR: A 3D PRINTED OPTION FOR PRESSURE CONTROLLED VENTILATION

Alex Brito MD
Oregon Health
Sciences University
Portland, OR

Evan Fontaine MBME
Oregon Health Sciences
University
Portland, OR

**S. James El Haddi MD
MS**
Florida Atlantic
University
Boca Raton, FL

Albert Chi MD FACS
Oregon Health Sciences
University
Portland, OR

ABSTRACT

During the Coronavirus-19, or COVID-19, pandemic there was an early shortage of available ventilators. Domestic production was limited by dependence on overseas sources of raw materials despite partnering with automotive manufacturers. Our group has developed a 3D printed alternative called the CRISIS ventilator. Its design is similar to existing resuscitator devices on the market and uses a modified Pressure-Control ventilation. Here we compare the performance of the device on a simulated ARDS lung and handling of different clinical scenarios included tension pneumothorax and bronchospasm.

Keywords: COVID-19, Ventilator, 3D printing, Resuscitation

[3]. Hospitals prepared for the worst and began creating strategies to share ventilators between patients [4]. 3D printing, an additive manufacturing process, is a solution to current the barriers in manufacturing of medical devices. Indeed, the widespread availability of the technology has already been used throughout the pandemic to fill in supply gaps with personal protective equipment[5]. Our group utilized the relative availability of the technology to develop a 3D printed ventilator which we call the CRISIS ventilator. The device which is detailed in this article utilizes only two parts which are not 3D printed and the device functions without any electrical components.

1. INTRODUCTION

During the spring of 2020, the first cases of Coronavirus 2019, or COVID 19, was first reported in the United States. By April 10th, the state of New York had reached over 170,000 reported cases and 12,000 deaths[1]. Due to the rate of hypoxemia and respiratory failure many patients were intubated and in critical condition. As cases continued to surge, the United States government deployed their strategic national stockpile of ventilators, however many of the devices were poorly maintained and thus unusable or even missing parts[2]. While attempting to transition domestic automotive manufacturers to production of ventilators, dependence of foreign materials hindered mass production

2. MATERIALS AND METHODS

The 3D printed CRISIS ventilator was manufactured using Nylon-12 with a selective laser sintering industrial printer donated from a local company which produces medical devices (3D Systems Portland, OR) in combination with parts manufactured locally with a FDM extruder Prusa MK3 (Prusa Research Prague, CZ) using Polyethylene Terephthalate. This material and process were chosen because of the decreased porosity and high heat tolerance which could make the device autoclavable. The device uses a hand-cut shore D-50 0.1mm silicon membrane (Jiawanshun Dancheng Zohoukou, China) and a stainless-steel type 316 spring (Lee Spring Brooklyn, NY). Materials were selected because of availability in our lab. The device was compared to the Go2Vent (Vortran Medical Sacramento, CA) on a calibrated Dual-Adult Test Lung

(Michigan Instruments Grand Rapids, MI). Compliance and resistances were determined based on manufacturer recommendations and were concordant with previously published studies [6]. Due to limitations in available supplies with the GO2VENT only three of each device were utilized.

Adjustable parameters on the CRISIS vent include respiratory rate and peak inspiratory pressure. Adjusting the respiratory rate changes the frequency of cycling rather than setting an absolute rate, and with changes in peak inspiratory pressure and compliance the actual rate varies. Similarly, the peak inspiratory pressure setting affects the sensitivity of inspiratory release/beginning of exhalation and varies with set rate and compliance.

Ten second intervals timed include a minimum of two respiratory cycles were examined to compare performance in the simulated clinical scenarios. This was chosen due to inherent limitations of the measurement device. When looking at average performances in the different scenarios, multiple respiratory parameters were evaluated over two-minute periods. Performance after prolonged use (>48hrs), dropping, and autoclaving was examined internally and will be reported separately.

2.1 Acute Respiratory Distress Lung

Each ventilator was connected to a blended oxygen supply and a set flow rate of 30L/min. The ventilators were connected in-line to a Fluke VT650 gas analyzer (Fluke Biomedical, Cleveland, OH). The lung simulator was set to a compliance of 0.02 L/cmH₂O for each lung with a set airway resistance RP5 cmH₂O/L/sec to model an adult male patient with severe ARDS. The Peak Inspiratory Pressure was adjusted to produce tidal volumes of 450-560mL concordant with a range of 6-8cc/kg in a 70kg predicted body weight as per the recommendations from the ARDSnet data [7-8] and targeted to a respiratory rate of 13. Given the mechanical natures of both devices the rate and volumes were set as close as was tolerated with continual respiratory cycling. The pressure changes over time, flow rate over time, and airway volume over time were collected for two full respiratory cycles. Full ventilation with Positive End Expiratory Pressure, Peak Inspiratory Pressure, Respiratory Rate, Tidal Volumes, and Minute Ventilation collected every second and averaged over the two-minute interval.

2.2 Tension Pneumothorax

The ventilator and lungs were set up as in 2.1 above with the exception that an initial compliance of 0.05 L/cmH₂O for each lung. Initial respiratory cycles of pressure, flow rate, and airway volume over time were collected for at least two breaths over 10 seconds. Again, multiple respiratory parameters were measured over a two-minute interval. One of the lungs was disconnected and the

compliance was changed to 0.02 L/cmH₂O as per manufacturer recommendations for simulation of a tension pneumothorax and the measurements were repeated without changing the ventilator settings. Of note only one of the lungs in the dual-lung setup had their compliance changed to simulate an unequal compliance as would be established in tension physiology.

2.3 Asthma/Bronchospasm

The ventilator and lungs were set up as in 2.2 with the initial lung compliance of 0.05 L/cmH₂O for each lung with an airway resistance of RP5 cmH₂O/L/sec as per manufacturer guidelines. Preliminary breath tracing data was again collected over a 10s interval and multiple respiratory dynamic measurements were collected over a two-minute interval. The airway circuit was disconnected, and the airway resistance simulator was transitioned to an RP50 cmH₂O/L/sec resistor. The measurements were then repeated for each device without changing the ventilator settings.

2.3 Data Handling

The data was collected and placed into a spreadsheet using Microsoft Excel (Microsoft Corporation Redmond, WA). The data was parsed and was sorted and averaged using a custom designed script in MATLAB (MathWorks Natick, MA). All graphs were created using MATLAB. Because of the high frequency of measurements within a single of experiment, all data points within a single simulation that were more than three standard deviations away from the mean were considered an outlier and removed from the final data set for analysis.

3. RESULTS AND DISCUSSION

1. Top Cover
2. Pressure Selector Cam
3. Top Housing
4. Slider
5. Lever-arm/Manual mode
6. Spring
7. Membrane housing upper
8. Membrane topper
9. Silicone Membrane
10. Membrane housing lower
11. Pressure Chamber
12. Rate Selector

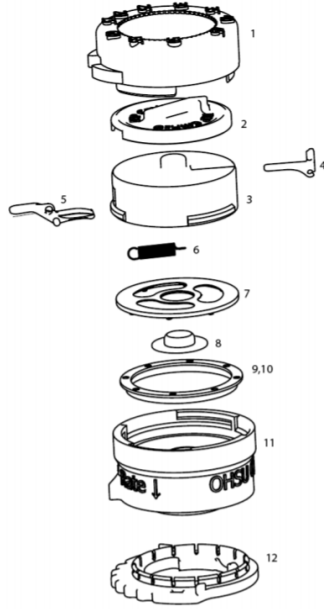

FIGURE 1: Diagram of the CRISIS ventilator. Note that only the spring (6) and silicon membrane (9) are not produced using a 3D printer. The base of the device fits standard 22mm ventilator tubing.

3.1 Results and Figures

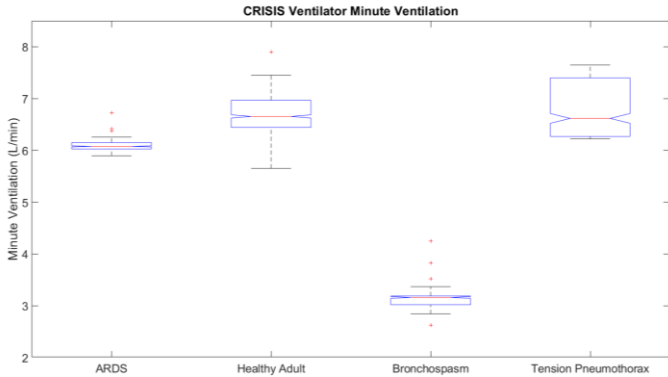

FIGURE 2: CRISIS Ventilator Minute Ventilation (L/min) under different (patho)physiologic scenarios.

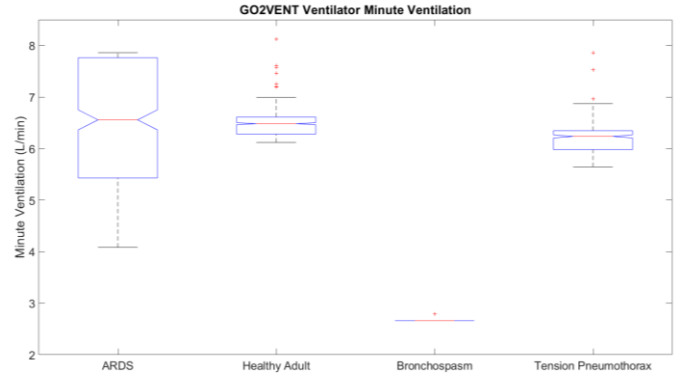

FIGURE 3: GO2VENT Ventilator Minute Ventilation(L/min) under different (patho)physiologic scenarios.

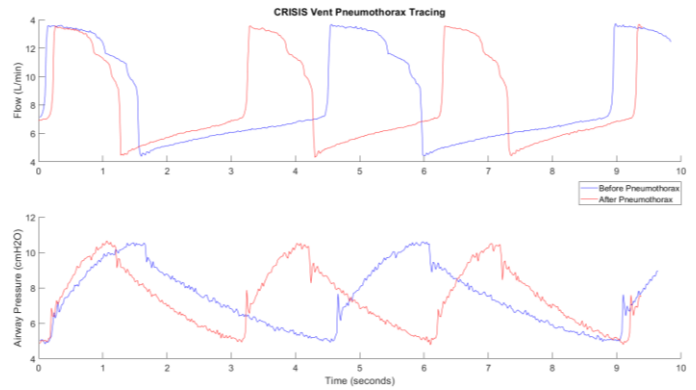

FIGURE 4: CRISIS ventilator before and after tension pneumothorax. Note increase in the respiratory rate and prolonged inspiratory time.

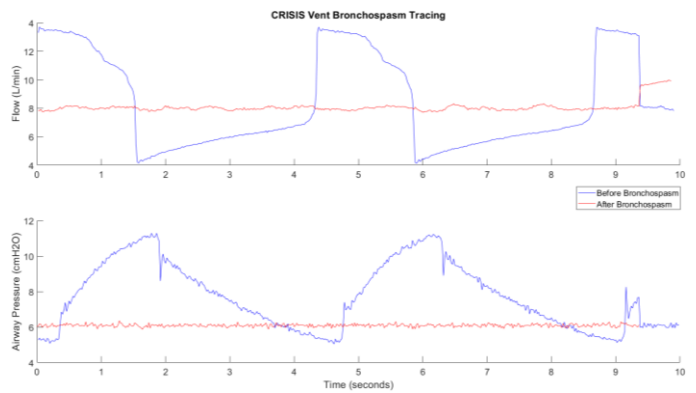

FIGURE 5: CRISIS ventilator before and after Bronchospasm. Note that the ventilator is unable to produce adequate airway volumes after introduction of spasm without intervention.

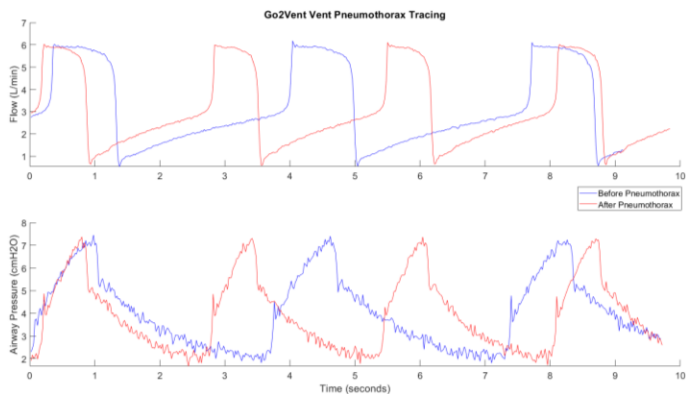

FIGURE 6: Go2Vent ventilator before and after tension pneumothorax. Note increase in the respiratory rate and prolonged inspiratory time.

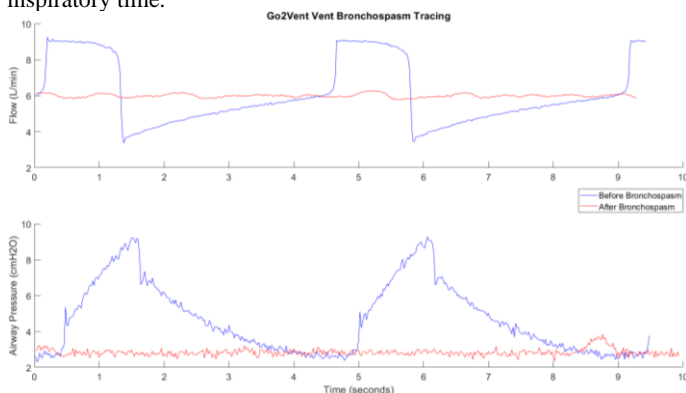

FIGURE 7: Go2Vent ventilator before and after Bronchospasm. Note that the ventilator is unable to produce adequate airway volumes after introduction of spasm without intervention.

| | CRISIS | | GO2VENT | |
|---|--------|------|---------|------|
| | Avg | SD | Avg | SD |
| Tidal Volume (mL) | 534.0 | 20.7 | 532.2 | 19.0 |
| Peak Inspiratory Pressure (cmH ₂ O) | 11.5 | 0.77 | 9.1 | 0.31 |
| Positive End Expiratory Pressure (cmH ₂ O) | 4.9 | 0.48 | 3.4 | 0.79 |
| Respiratory Rate (Breaths per Minute) | 13.7 | 2.0 | 13.1 | 1.6 |

FIGURE 8: Respiratory parameters averaged for all healthy adult lung model controls obtained. SD is the standard deviation for all data obtained during the two-minute measurement period.

The CRISIS ventilator was designed and optimized to be utilized in lungs with poor compliance such as those encountered in Acute Respiratory Distress Syndrome and in neonates. This device's safe operational parameters have been noted in prior testing to be in the 6-8cc/kg range in poorly compliant lungs. As shown in Figures 2-3, both ventilators can provide respiratory support in the setting of ARDS with the CRISIS ventilator providing an average Minute Ventilation of 6.06L/min \pm 0.15(standard deviation) and the GO2VENT delivering 6.26 L/min \pm 1.24(standard deviation). Both ventilators showed a significant decrease in their ability to provide adequate minute ventilation in the setting of acute bronchospasm with each ventilator delivering an average minute ventilation <4L/min as shown in Figures 4-5. On average the devices evaluated did not provide continuous inhalation/exhalation cycles as highlighted in Figures 6 and 7. Both the CRISIS and GO2VENT ventilators behaved intuitively based on their shared mechanism of pressure regulated ventilation and increased respiratory rates and tidal volumes to produce a comparable minute ventilation of 6.77 L/min \pm 0.49 and 6.24 L/min \pm 0.26 respectively in the setting of a simulated tension pneumothorax. When set to an ideal compliance of a healthy adult male of 100mL/cmH₂O, the CRISIS ventilator was able to deliver an average minute ventilation of 6.72 L/min \pm 0.37 and the GO2VENT delivered 6.48L/min \pm 0.29. The within-experiment breath to breath variance was noted to be on average higher in the GO2VENT at 0.11mL versus 0.02mL when excluding bronchospasm. Breath-to-breath variance cannot be accurately calculated due to the sample rate of the FLUKE measuring device.

3.2 Discussion

Given that both ventilators have a shared underlying mechanism of providing positive pressure regulated ventilation, it is understandable that both devices would perform similarly in the setting of ventilation an adult healthy lung, ARDS lung, tension pneumothorax, and bronchospasm. Further, since neither ventilator utilizes electric components, they would appear to share a common issue in that neither can alert medical providers in the setting of failure to provide adequate ventilation. Clearly in the clinical setting due diligence is required as patients who are at risk of bronchospasm may benefit from other means of ventilatory support.

Of note, given that both devices utilize a modified pressure-control ventilation the tidal volume delivered in each device is inherently dependent on the interaction between the supplied oxygen flow rates, the spring pressure applied to the release valve system in each device, and the area of the exhale valve in the pressure chamber within each device. During the experiment, the peak inspiratory pressure required to achieve the appropriate tidal volumes may be inherently different for each device. The resultant difference

in peak inspiratory pressure for each device obtaining a similar tidal volume for a given compliance is highlighted in Figure 8. Multiple studies have failed to show the superiority of Pressure Control vs Volume Control in the setting of ARDS [9], however managing tidal volumes and ventilation is clearly important in critically ill patients. Since ventilatory clearance of carbon dioxide is dependent on the minute ventilation, this resultant parameter is what allows for direct comparisons of the devices. PEEP, like the fractional inspiration of oxygen, are settings which can be fine-tuned in this and many standard ventilators to adjust oxygen requirements in patients as needed based on clinical metrics. Further, throughout the duration of the experiment there was no appreciable difference in delivery of PEEP, PIP, or MV throughout the experiment in healthy lungs models. Internal testing has shown there is some drift in the performance of the device when performing continuously over the course of 48 hours and thus, as with any critically ill patients, routine assessment of respiratory status will be critical.

During acute changes in lung compliance, such as with tension pneumothorax, both devices were observed to increase their respiratory rate without an obvious change in the delivered minute ventilation. This is elucidated in Figures 4 and 6 where the post-tension figures in red have more breath cycles within the same timeframe. The CRISIS ventilator increased the respiratory rate from 13 to 19 while decreasing the expiratory tidal volume from 500mL to 358mL. The GO2VENT increased the respiratory rate from 13 to 17 while decreasing the expiratory tidal volume from 500mL to 359mL. While respiratory rate in most conventional ventilators is monitored and adjusted, both the GO2VENT and CRISIS devices utilize variable resistance to exhalation outflow which can intrinsically alter the I:E ratios. Anecdotal internal evaluation of our device has suggested that this can alter the positive end expiratory pressures and achievable peak inspiratory pressure with work ongoing to characterize the achievable parameters.

While the CRISIS ventilator highlighted in this study did require the use of combinations of varied materials, our group has ongoing studies with the use of a device which utilizes Nylon-12 printed using selective laser sintering which would allow for autoclaving. Our group hopes to demonstrate that the autoclaving does not affect performance of the device. While the device could easily be manufactured using traditional bulk manufacturing techniques, e.g. injection molding, this would require centralized production of a mold which may not allow for rapid on-site deployment in the setting of a ventilator surge. In addition, further studies are needed to verify that the proposed device can provide adequate ventilatory support without adverse barotrauma and hemodynamic compromise over longer periods of time. Animal studies are planned to begin shortly which will allow for verification of the merits of a reusable and 3D printed device, which may be useful in

the event of another ventilator surge or in settings where electricity is limited.

3.3 Limitations

It is worth noting that the CRISIS device highlighted in this article, like the GO2VENT, meets FDA technical classifications as a resuscitator. As our group pushes forward with clinical testing we plan to continue with this classification as the merits of this device, being able to be produced on site and allow for performance in a variety of clinical scenarios without primary dependence on continuous electrical power, make it attractive for a variety of settings. The first is that the device can be made cheaply, and production can be distributed on-site using commercially available devices negating the need for shipping to rural or austere sites. One of the drawbacks is that the device is dependent on a constant pressurized oxygen source which in austere environments and during pandemics can be difficult to acquire. Further, the device does not have the intrinsic ability to monitor the respiratory dynamics of the patient and does require the use of another device to establish appropriate ventilation settings for a critically ill patient. In the setting of acute changes in airway resistance such as bronchospasm the device's mechanism stalls resulting in continuously positive airway pressure, which can provide some ventilatory support in a patient with ongoing spontaneous respirations but would be disastrous in the patient infused with either altered respiratory drive or undergoing infusion of paralytics. While these are indeed limitations of this device, they are also limitations observed in other similar devices in clinical use today that do not have the benefit of the possibility of on-site scalable manufacture afforded by 3D printing.

4. CONCLUSION

During the COVID-19 pandemic, the shortcomings of the physical strategic stockpile were highlighted. Furthermore, the global ventilator surge made dependence on overseas materials compound the limitations in domestic production of ventilators. Here we highlight our production of the CRISIS ventilator: a 3D printed ventilator which can perform comparably to the GO2VENT by Vortran which utilizes a similar mode of ventilation and does not rely on electricity for function.

REFERENCES

- [1] Dong, E., Du, H., and Gardner, L., 2020, "An Interactive Web-Based Dashboard to Track COVID-19 in Real Time," *Lancet Infect. Dis.*, **20**(5), pp. 533–534.
- [2] Sanger, D. E., Kanno-Youngs, Z., and Kulish, N., 2020, "A Ventilator Stockpile, With One Hitch: Thousands Do Not Work," *New York Times*, pp. 3–5.

- [3] Gregg, A., Lamothe, D., and Davenport, C., 2020, "Making Automakers Churn out Ventilators Won't Be so Easy, Manufacturers and Former Officials Say," Washington Post.
- [4] Clarke, A. L., Stephens, A. F., Liao, S., Byrne, T. J., and Gregory, S. D., 2020, "Coping with COVID-19: Ventilator Splitting with Differential Driving Pressures Using Standard Hospital Equipment," *Anaesthesia*, **75**(7), pp. 872–880.
- [5] Choong, Y. Y. C., Tan, H. W., Patel, D. C., Choong, W. T. N., Chen, C. H., Low, H. Y., Tan, M. J., Patel, C. D., and Chua, C. K., 2020, "The Global Rise of 3D Printing during the COVID-19 Pandemic," *Nat. Rev. Mater.*, **5**(9), pp. 637–639.
- [6] Harris, R. S., 2005, "Pressure-Volume Curves of the Respiratory System," *Respir. Care*, **50**(1), pp. 78–98; discussion 98-9.
- [7] Slutsky, A. S., and Ranieri, V. M., 2000, "Mechanical Ventilation: Lessons from the ARDSNet Trial," *Respir. Res.*, **1**(2), pp. 73–77.
- [8] Acute Respiratory Distress Syndrome Network, Brower, R. G., Matthay, M. A., Morris, A., Schoenfeld, D., Thompson, B. T., and Wheeler, A., 2000, "Ventilation with Lower Tidal Volumes as Compared with Traditional Tidal Volumes for Acute Lung Injury and the Acute Respiratory Distress Syndrome," *N. Engl. J. Med.*, **342**(18), pp. 1301–8.
- [9] Chacko, B., Peter, J. V., Tharyan, P., John, G., and Jeyaseelan, L., 2015, "Pressure-Controlled versus Volume-Controlled Ventilation for Acute Respiratory Failure Due to Acute Lung Injury (ALI) or Acute Respiratory Distress Syndrome (ARDS)," *Cochrane Database Syst. Rev.*, **2017**(6).