



The Society shall not be responsible for statements or opinions advanced in papers or discussion at meetings of the Society or of its Divisions or Sections, or printed in its publications. Discussion is printed only if the paper is published in an ASME Journal. Authorization to photocopy material for internal or personal use under circumstance not falling within the fair use provisions of the Copyright Act is granted by ASME to libraries and other users registered with the Copyright Clearance Center (CCC) Transactional Reporting Service provided that the base fee of \$0.30 per page is paid directly to the CCC, 27 Congress Street, Salem MA 01970. Requests for special permission or bulk reproduction should be addressed to the ASME Technical Publishing Department.

Copyright © 1997 by ASME

All Rights Reserved

Printed in U.S.A

FLOW MEASUREMENTS IN A REACTIVE MODEL OF A GAS TURBINE COMBUSTION CHAMBER

D. Fiaschi*, G. Manfreda*, L. Bonciani**

* Dipartimento di Energetica "Sergio Stecco", Università di Firenze, Italy

** Nuovo Pignone S.p.A., Firenze, Italy



ABSTRACT

The results of the investigation of the flow in a transparent (quartz tube) downscaled ($\approx 1:3$) model of a lean-premix type gas turbine combustion chamber are presented and discussed. The model was tested at atmospheric pressure in reacting conditions; flow measurements were taken by a two-channel fiber-optic laser doppler velocimeter, using Al_2O_3 seeding of the air flowrate. The measurements cover a wide flow field inside the combustion chamber, including flame development and recirculating regions. Long-time samples (10 - 20 s) were used in order to achieve a good accuracy in the measurement of average flow conditions over the whole flow field; this involved a limited capability of representation of high-frequency components of turbulence, which could be locally obtained with optimization of the data rate and seeding conditions. Fast measurements were also locally performed where the seeding conditions were favourable. Integral variables and power spectra for reacting conditions show some distinctive aspects for the turbulence structure of reacting turbulent flows in confined spaces. Further measurements cover the outlet throat section of the premix combustor, demonstrating the persistence of a radial flow component on account of wall curvature effects and a certain degree of asymmetry in the inlet velocity distribution.

MODEL TESTING AND THE DEVELOPMENT OF INDUSTRIAL GAS TURBINE COMBUSTION CHAMBERS

Recent advances on industrial gas turbine combustion chambers are all aimed at the capability of achieving very low (single-digit) emissions, with special reference to NO_x . Of course this should imply no substantial growth in CO or HC emissions, which is difficult to obtain with conventional designs (Lefebvre, 1983; Angello and Lowe, 1989). It is presently recognized that one of the viable ways to this development, with special reference to industrial gas turbines firing natural gas, is the choice of a lean-premix combustion chamber normally operating in dry conditions (Lefebvre, 1995). In order to maintain low emission levels over a wide operating range and operate within flammability limits (Strahle, 1993), this typically involves also some kind of variable geometry at least in the primary zone, as the combustion fuel-to-air ratio must be kept within fairly narrow limits using fuel or air staging.

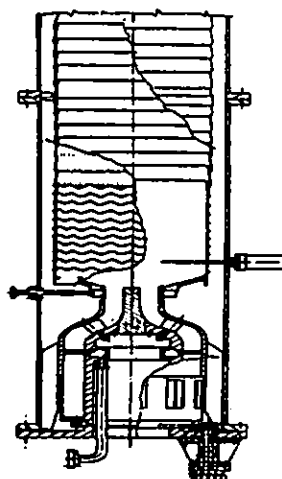

Figure 1 - Sketch of combustion chamber

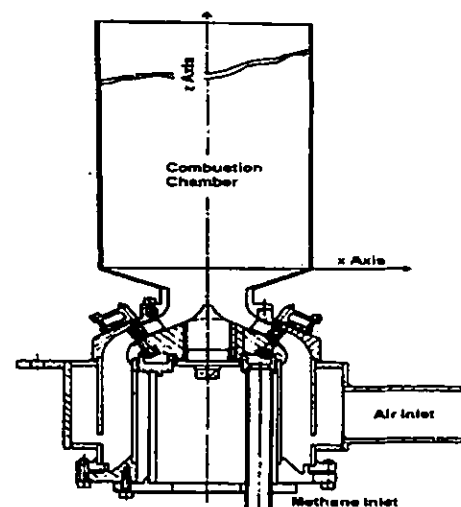

Figure 2 - Sketch of reactive model

Model testing is a standard tool for the initial phase of development of new gas turbine combustors. At Nuovo Pignone, several small testing facility are available where research and development work on atmospheric models of gas turbine

combustors is constantly in progress, mainly with the aim of solving problems of flashback, control of liner temperature, and pressure oscillations which are commonly encountered during the development of new combustion chambers (Bonciani et al., 1992). Recently, one of these test benches has been adapted for velocity surveys by means of Laser Doppler Velocimetry. Further development of the new combustors usually involves full-scale testing in a large test rig operating at atmospheric pressure, and finally experimentation on instrumented gas turbine prototypes. Typically, detailed testing (Velocity surveys; Temperature measurements; Flame visualizations; etc.) can be performed only in the case of models or on the full-scale atmospheric test rig, while direct gas turbine testing is limited to final assessment of prototype operation (including pressure oscillations, pressure drop, pattern factor, etc.) before commercial production.

In the present case, the combustor under study (Figure 1) is that developed for the Nuovo Pignone PGT-5 gas turbine, which is a modern twin-spool heavy-duty engine equipped with variable compressor and power turbine (inlet nozzles) geometry. For the model (Figure 2), all dimensions were scaled down by a factor 3; under atmospheric pressure operation, the nominal thermal load was about 250 kW. An air flowrate of approximately $0.12 \text{ m}^3/\text{s}$ was supplied by the Nuovo Pignone compressed air grid at two lateral 180° spaced manifolds on the mixing chamber; a pressure regulator ensured a fairly constant flowrate and pressure reduction close to the atmospheric level. Low-pressure natural gas was separately fed to the mixing chamber, again with fuel flowrate adjustable by means of a set of control valves and a pressure regulator. The shape of the premix chamber was reproduced with good detail, with the exception of variable geometry which was not included in the model. Flame stabilization in this combustion chamber is by a sudden enlargement (step diffusion) at premix chamber exit; the inlet premixed flow has no nominal swirl component, provided a perfect alignment of all the adjustable swirl vanes is ensured. The slight differences between combustion chamber and model (Figures 1 and 2) are related to different solutions which were experimented during prototype development. Among these differences, the most significant is a prolonged inlet throat on the final prototype (Figure 1), which was necessary as evidence came from the model tests of a residual radial component at combustion chamber inlet. The liner was substituted in the model by a transparent quartz tube of about 160 mm bore, thus guaranteeing full-field optical access; the surface quality was necessarily non-optical, which means that a certain degree of decrease in signal-to noise ratio had to be accepted.

MEASUREMENT TECHNIQUE

The measurement system was a modern two-component LDV system by Aerometrics, including:

- an Argon-Ion Laser source of 6 W nominal power
- a beam splitter and conditioning unit
- two Bragg cell modules allowing measurements of flow reversal
- a fiber-drive unit for beam transmission to the optics
- a beam expander/optical unit with a long-focus 1000 mm lens, allowing a safe distance between the flame and the optics
- a three-axis traversing unit for the optical head with computer control
- an advanced signal processing unit of the spectral type (DSA)
- a computer for control of the test and storage of data.

The original windows-oriented software supplied by Aerometrics was used for instrument setting and test running.

The system for flow seeding had to be developed for this test rig and model; having decided to use Aluminum oxide as a seeder, on account of availability at relatively low price as a fine-polishing abrasive and suitability for use under reacting conditions, a double-dilution circuit was designed which allowed seeding of particles under roughly-controlled size conditions. A fluidized-bed seeding generator, followed by a cyclone-type particle sizer (designed for a nominal size of $1 \mu\text{m}$) was the finally optimized solution after several attempts with different systems. Fluid seeding took place on the air stream; natural gas was directly fed to the premix chamber where seeded air was also admitted. On account of the non-optical and curved transparent surface, and of the typically non-spherical geometry of aluminum oxide particles, a low data rate had to be accepted: peak values on the centerline of the model locally achieved 5000-8000 data/second; however, it was necessary to limit seeding in order not to alter the flame temperature pattern (aluminum oxide has a large heat capacity compared to combustion gases), and in order to ensure an adequate test duration with one charge of particles (15-30 min.).

TEST CONDITIONS AND MEASURABLE QUANTITIES

The present tests refer to a value of the excess air factor $\lambda \approx 1.75$, which is typical of lean premix-type combustion chambers. The optics arrangements allowed the measurement of two components; on account of symmetry of the model about the vertical axis, the measured velocity components were:

- The axial component V_a in all measurement points
- The radial component V_r on the combustion chamber centerline
- The circumferential component V_c at off-axis locations.

This choice was imposed by the impossibility of achieving adequate signal-to-noise ratios and data rates when lateral off-axis traversing of the optical head was attempted, on account of the disturbing effects produced by beam incidence at a large angle over the curved surface (Figure 3 a). The flow survey basically consisted in displacing the optical head vertically (z direction) over a 500 mm range and horizontally in the main beam (x) direction for about 80 mm, with the head positioned close to the model centerline (actually 5mm off-axis in order to avoid direct reflection from the quartz surface into the receiving optics, which saturated the scattered light detector; see Figures 3b and 3c for the arrangement and reference system).

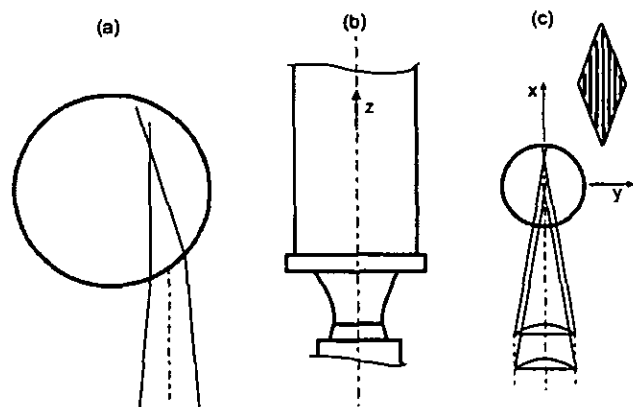

Figure 3 - Measurement arrangement and reference system

The present test campaign was mainly aimed to a complete field survey, with accurate measurement of average flow velocity components, and possibly details about turbulence and its structure. To his end, a relatively fine measurement grid covering 28 axial (from $z/(2R) = 0.1$ to $z/(2R) = 4$) and 5 radial stations ($r/R = 0.05, 0.26, 0.45, 0.57, 0.66$) was used

DATA REDUCTION

A typical problem of laser flow measurements is the dependence of signal availability on local seeding conditions. When applied to field measurements, this means that statistical convalidation and signal information are fundamentally different passing from clean flow, high data-rate regions, to separated and/or recirculating flow zones where the data rate falls to very low values on account of inadequate seeding (which sums its negative effects to other problems affecting signal validation, such as turbulence level and curvature of the transparent optical access surface). Moreover, the sample of data is not evenly spaced in time, as a valid signal is produced only when particles pass through the probe volume. In order to minimize these problems and achieve the desired field description capability, the following data reduction procedure was developed:

- Data were taken under time rather than sample length control, ensuring that for all measurement points the sample duration was between 12 s and 20 s. In order to achieve this without incurring in a prohibitively long sample for high data-rate regions (where more than 2000 data/s could often be taken), the inhibit measurement function was activated on the DSA signal processor, under control of a waveform synthesizer.
- "Fast" samples were also taken where possible deactivating the inhibit function, in order to maintain high-frequency turbulence spectrum information where this was available.
- The measured data were resampled with a constant time interval, which was chosen as that having the highest probability within the sample according to the distribution of time history. A sample and hold resampling scheme was considered adequate according to the experience of other authors (Tropea and Jovanovic, 1992)
- Average and fluctuating values of velocity components were calculated using a velocity bias correction.
- A spectrum analysis of the sample was run by an improved Welch procedure using zero-padding and overlapping windows; slow- and fast-sample spectra were reduced to a common scale where both were available.

An idea of the uneven distribution of data rate can be gathered from Figure 4, which represents the Nyquist folding frequency (corresponding to the highest frequency bar in the power spectrum) of the slow samples after resampling over the measurement field. It can be seen that, even if values exceeding 150 Hz were possible in the flame development region, a frequency limit lower than 30 Hz was typical of near-wall, recirculating regions.

Figure 5 collects average data for the axial velocity component V_a , non-dimensionalized with respect to the average, non-reacting, flow velocity (referred to the 160 mm bore quartz tube). Wall recirculation appears to be present up to $z/(2R) = 1.5$, while the flame structure appears to be not yet completely developed after nearly four diameters of the combustion chamber. The fluctuating v'_a component is reported in Figure 6, and shows that a low turbulence level is typical of the flame centerline, while turbulence intensity is more than doubled in the entrainment region located close to the wall from $z/(2R) = 1$ to $z/(2R) = 1.5$.

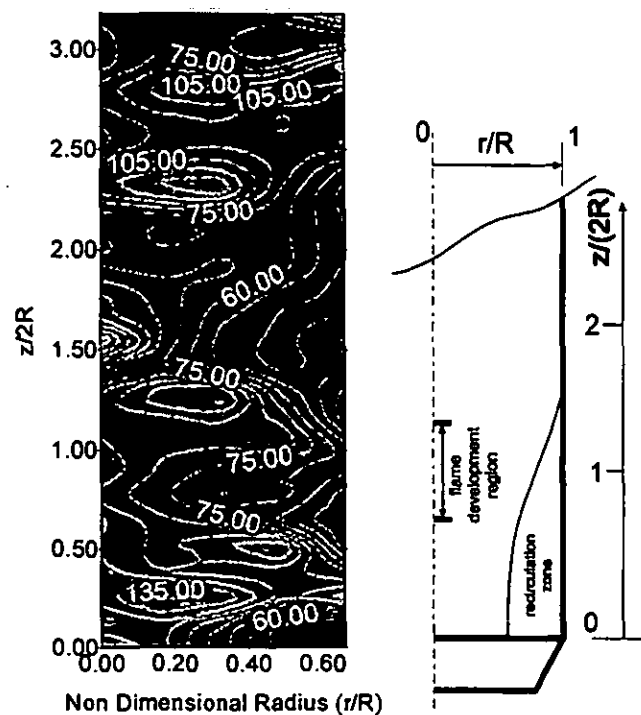

Non Dimensional Radius (r/R)
Figure 4 - Distribution of the Nyquist folding frequency over the measurement domain and scheme of the flame structure (on the right side)

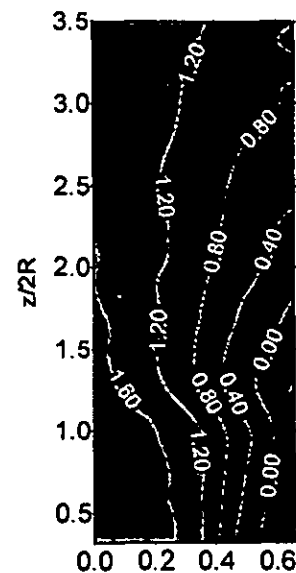

Non Dimensional Radius (r/R)
Figure 5 - Measured V_a component of velocity

Figure 7 shows the measured distribution of axial velocity V_a in the case of non-reacting flow; it can be noticed that combustion causes a notable and expected expansion of the corner recirculation region.

The radial velocity component was measured at the centerline of the model. Its distribution along the axis (Figure 8) shows a rather uniform decay after the initial large value (over 20% of the average, non-reacting, flow velocity) which is a consequence of the divergence of streamlines immediately after the step diffusion. A local minimum can be observed between $z/(2R) = 1$ and $z/(2R) =$

1.5, which corresponds visually to the flame front and can be justified by the strong axial acceleration induced by the heating of the products of reaction.

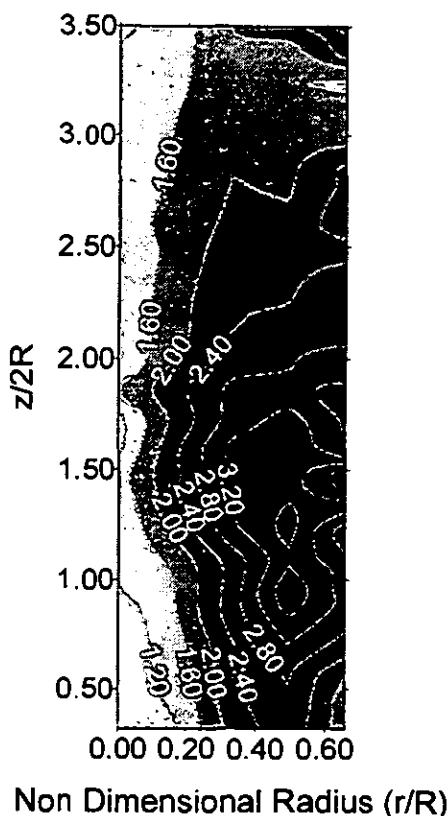

Figure 6 - Fluctuating v'_r component

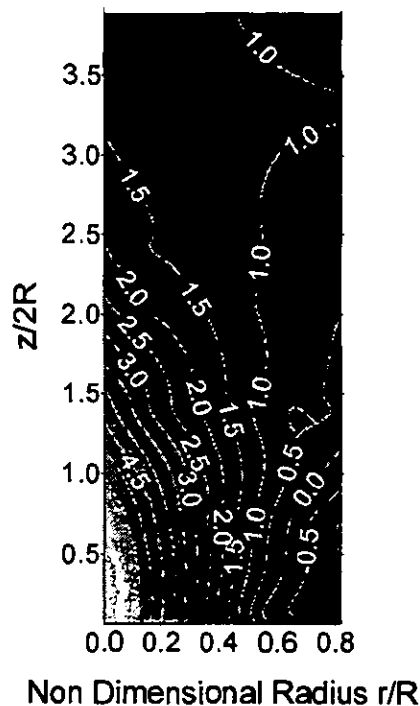

Figure 7 - Measured distribution of axial velocity (Non-reacting flow)

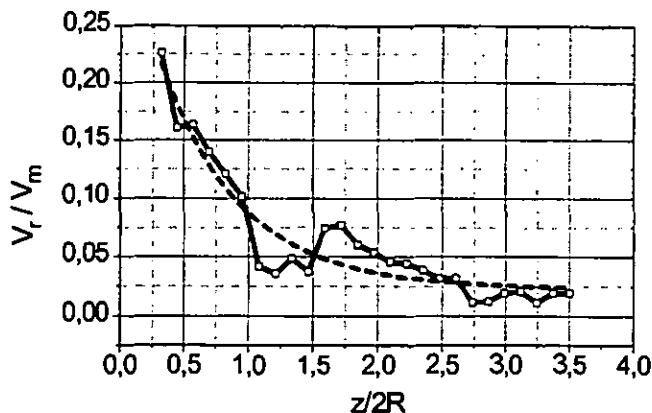

Figure 8 - Measured radial velocity component decay along centerline with polynomial fit

Preliminarily to the tests, a computer simulation of the reacting flow in the model was attempted using FLUENT 4.23 code and a grid consisting of 11250 nodes. The simulation assumed axial symmetry and axial inlet of premixed reactants. The turbulence model was the standard $k-\epsilon$, and wall heat transfer conditions were uniform and corresponding to a calculation of the radiant heat loss to the metal shield, which consisted in a metal cabin with walls at about 0.15 m from the quartz tube. The calculated flow (Figure 9 for the calculated V_a component) shows a much faster flow development into a uniform turbulent flow, with a fairly less extended recirculation region at the wall after the diffusion step. In order to understand this behavior, it was decided to check the flow inlet conditions by arranging a traverse of the probe volume along the inlet throat section. The results of these measurements (Figure 10) indicate the existence of a relevant radial component at inlet, with flow directed towards the centerline (centripetal component); moreover, a certain dissymmetry existed between the left and right side of the channel (measurements in the model were only done on the right side), which was presumably due to nonuniform flow distribution from the two inlet air manifolds. The existence of a centripetal radial component of velocity at inlet was justified by the persistence of the effects of wall curvature (conversion of the flow from radial to axial direction), as can be inferred from the sketch of the throat section in Figure 2.

ANALYSIS OF TURBULENCE STRUCTURE

A typical power spectrum of turbulence, calculated for the v'_a component, is shown in Figure 11; along the model centerline, it was possible to run fast (maximum-data rate) and slow (inhibit switch) data acquisitions, thereby allowing the extension of the power spectrum over a broad range (from a few Hz to about 1000 Hz). However, this is apparently not sufficient to gather information about the dissipative range, which is located at even higher frequencies (Tennekes and Lumley, 1972); in fact, up to 1000 Hz the frequency spectrum shows no significant sign of rapid decay. Consequently, no estimate of the turbulence dissipation scale was attempted, while data were considered adequate for an estimate of the turbulence macroscale (Hinze, 1975).

In order to efficiently calculate the turbulence macroscale, it is first necessary to produce the autocorrelation function, by an inverse Fourier transform of the power spectrum. A typical result, referred to the sample of Figure 11, is shown in Figure 12.

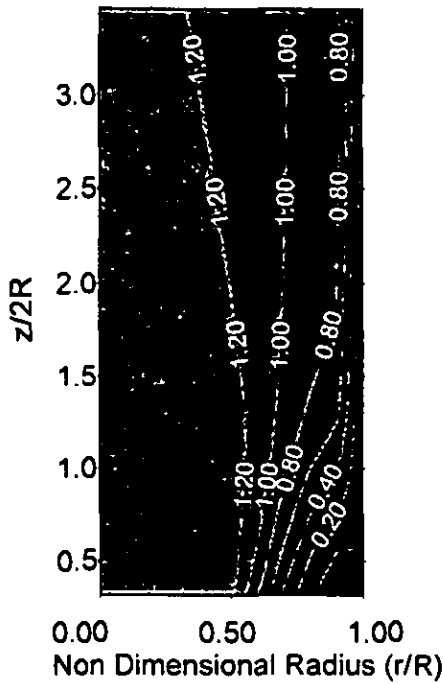

Figure 9 - Calculated values of axial velocity component

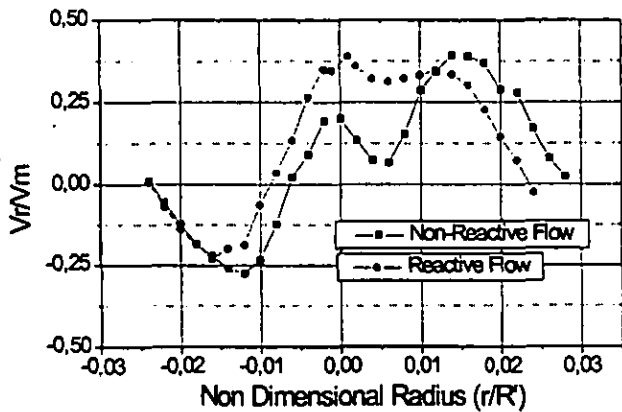
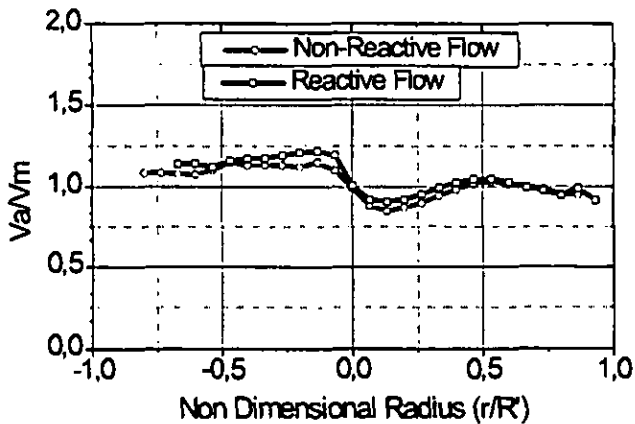

Figure 10 - Axial and radial velocity components in the inlet throat

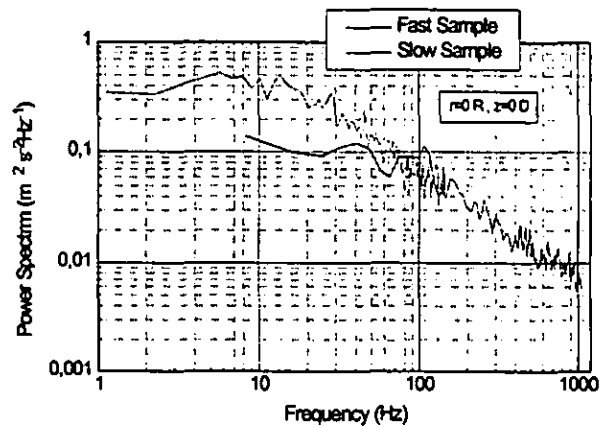

Figure 11 - v'_a power spectrum ($m^2 s^{-4} Hz^{-1}$) for $r/R = 0, z/(2R) = 0$

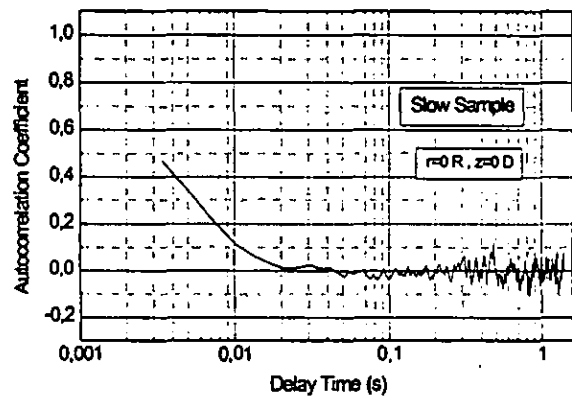

Figure 12 - v'_a sample autocorrelation coefficient for $r/R = 0, z/(2R) = 0$

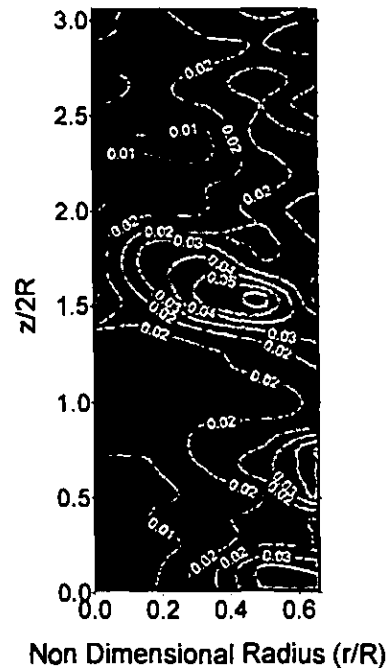

Figure 13 - Field distribution of time integral scale of turbulence

An integration of the autocorrelation function produces an estimate for the turbulence macroscale. This procedure was uniformly applied to all measurement points, in order to produce a distribution of the turbulence integral time scale over the whole measurement field. The results are collected in Figure 13. Even if significant errors are probably present, on account of the uneven distribution of data in time and of the sample length, it can be noticed that the turbulence macroscale (here represented as a time integral scale) is large in the corner, separated-flow region, while it gets consistently smaller (about ten times) along the flame front. On the whole, a field distribution of the time integral scale ranging from 0.005 to 0.05 s was confirmed.

CONCLUSIONS

The present test campaign demonstrated the possibility of running measurements in a model of a gas turbine combustion system by an advanced LDV system. Several problems were encountered, mainly connected with signal quality (on account of the limits of the optical access and of the properties of the seeding particles) and with the impossibility of achieving a sufficiently uniform seeding in both clean flow and recirculating regions. Data analysis included turbulence measurements and a check of the inlet flow conditions.

The main issues of the present work are the following:

- the mean flow survey indicates the persistence of a transitional behavior, in comparison to calculations showing a rapid development into a uniform turbulent flow. Accordingly, the extension of the wall recirculating flow region is much larger than in the prediction.
- as is common for premixed flames, the flame development region is quite extended and cannot be identified by a sharp positive gradient of velocity (which is typical of diffusion flames).
- the large extension of the wall recirculating flow can be partly accounted for by the existence of a centripetal (negative) component of V_p residual from wall curvature effects (radial-to axial bend at exit from premix chamber). Negative values of V_r were confirmed by a throat traverse before the step diffusion.
- the spectrum analysis confirms, with the persistence of an approximately linear decay of the power spectrum in the measured frequency range (exceeding 1000Hz), that the dissipative range of turbulence can be located at far larger frequencies. This supports the still developing structure of turbulence which was noticed in terms of mean variables. Energization of the turbulence structure from the mean flow is still taking place at the mid-frequencies hereby investigated ;

with respect to non-reacting flows, this should be associated with the combustion process.

- information about interaction between the mean flow and the turbulent structure can be gathered by the distribution of the turbulence integral scale; where this is large - as in the wall recirculation region - large eddies contribute to energization of turbulence at the expenses of the diffusing mean flow. On the other hand, relatively small values of the integral time scale of turbulence can be noticed in the flame development region.

To the gas turbine combustion chamber designer, the preceding issues can be useful for the general understanding of flow structure in premixed combustors; from the tests, directly useful information was also gathered about the extension of the recirculating region and the location and size of the flame front development zone.

According to the results obtained, further experimentation will be directly run on prototype combustion chambers installed on a gas turbine test rig, using a more limited optical access but with the intent of running detailed measurements in selected regions.

ACKNOWLEDGMENTS

The present work was run under a research contract grant between Nuovo Pignone Inc. and University of Florence. Financial support from the Italian Ministry of Scientific Research (MURST 40%) on its nationally coordinated program is also acknowledged.

LIST OF REFERENCES

- Angello, L., Lowe, P., 1989, "Dry Low-NOx combustion development for electric utility gas turbine application. A status report", ASME 89-GT-254.
- Bonciani, L., Ceccherini, G., Modi, R., Riva, A., Sangalli, L., 1994, "Development of dry Low-NOx combustors for Heavy-Duty Gas Turbines", Proceedings of FLOWERS 94, Firenze, Italy.
- Durst, F., Melling, A., Whitelaw, J.H., 1976, "Principles and Practice of Laser Doppler Anemometry", Academic Press, London.
- Hinze, J.O., 1975, "Turbulence", McGraw-Hill.
- Lefebvre, A.H., 1983, "Gas Turbine Combustion", Hemisphere Pub. Co., New York.
- Lefebvre, A.H., 1995, "The Role of Fuel Preparation in Low-Emission Combustion", Journal of Engineering for Gas Turbines and Power, 117, p. 617.
- Strahle, W.C. 1993, "An Introduction to Combustion", Gordon & Breach Sc. Publishers.
- Tennekes, H., Lumley, J.L., 1972, "A First Course in Turbulence", MIT Press, Boston.
- Tropea, C., Jovanovic, J., 1992, "Notes of the Advanced Short Course on Hot Wire and Laser Doppler Anemometry", Ljubljana, Turboinstitut.