



The Society shall not be responsible for statements or opinions advanced in papers or discussion at meetings of the Society or of its Divisions or Sections, or printed in its publications. Discussion is printed only if the paper is published in an ASME Journal. Papers are available from ASME for 15 months after the meeting.

Printed in U.S.A.

Copyright © 1994 by ASME

DEVELOPMENT OF THE TRENT ECONOPAC

Gerry A. Myers
Manager, Aero Product and CC Plant Configuration
Westinghouse Electric Corporation
Orlando, Florida

Anthony J. B. Jackson
Director, Technology
Rolls-Royce Gas Turbine Engines
(Canada) Inc.
Dorval, Quebec



ABSTRACT

Through an alliance established in 1992 between Westinghouse Electric Corporation and Rolls-Royce plc, a program has been implemented that will bring the industrial Trent aero engine to the power generation marketplace. The Rolls-Royce Trent has been initially sized at 50 MW, with a development potential to higher power ratings, and is offered by Westinghouse as a complete power generation package, the "Trent EconoPac".

The Trent EconoPac sets a new performance standard in the industry with a nominal simple cycle efficiency of 42 percent. It is also ideal for combined cycle and cogeneration applications; a net combined cycle power of 63 MW at 52 percent efficiency can be developed. This paper describes the Trent industrial engine and EconoPac and reviews the development program with emphasis on unique features that benefit the power plant operator.

NOMENCLATURE

BOV	Blow-off Valve
CO	Carbon monoxide
DLE	Dry Low Emissions
HP	High Pressure
Hz	Herz
IP	Intermediate Pressure
ISO	Standard Day Conditions as defined by the International Standards Organization. This corresponds to 14.7 PSIA (101.7 KPA) pressure and 59°F (288°K) temperature at sea level.
LP	Low Pressure
MW	Megawatts

NGV	Nozzle Guide Vane
NOx	Nitrous oxides
TET	Turbine Entry Temperature
VIGV's	Variable Inlet Guide Vanes

lb.	Pound (mass)
rpm	Revolutions per minute
sec	Second
vppm	Volume parts per million

1. INTRODUCTION

Westinghouse Electric Corporation and Rolls-Royce Industrial and Marine Gas Turbines Limited are working together to develop the 50-MW, 42 percent efficient, Trent EconoPac for the global power generation market. The first Trent EconoPac will be installed to generate electricity at a commercial installation in 1996. It is to be used for peaking, combined cycle, and cogeneration applications in 50- and 60-Hz markets. Dry low emission (DLE) combustors with dual fuel capability will be provided for fuel flexibility, and to satisfy increasingly stringent emissions worldwide.

2. TRENT AERO ENGINE

2.1 BACKGROUND

Since the late 1960s, Rolls-Royce has been successfully developing and producing the RB211 series of aero engines for civil and military transport aircraft. These engines were developed to respond to the need for larger, more efficient and more environmentally friendly aircraft, typified at the time by the wide body Boeing 747, Lockheed Tristar and Douglas DC10. This requirement resulted in all engine manufacturers producing high bypass

ratio, high overall pressure ratio aero engines. These engines, and their descendants, have been fitted to all aero civil aircraft from the early 1970s and indeed are being used to retrofit airframes such as the Boeing 727 and others. RB211 engines are technologically competitive and are supported by vigorous research and development programs.

"Trent" is the name given to the latest and largest in the RB211 series. There are several versions of the Trent at various thrusts (see Fig. 1). The Trent 700 was certified for airline use in 1993 and the Trent 800 will be certified in 1995. The Trent 890, currently in the design phase, is scheduled for service in 1997. The Trent EconoPac is based on the industrial version of the Trent 800, which is currently under development.

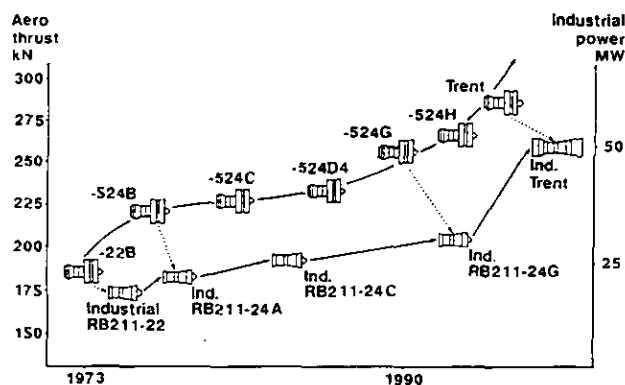

FIGURE 1: The RB211 Large Engine Family

The RB211 series ushered into service for the first time the three shaft concept in 1972. This concept has made the RB211 family readily convertible to ground based industrial purpose. RB211's have accumulated over 45 million hours in airline service at the date of this paper.

The 3-spool design of the RB211 family results in an optimized core compressor arrangement which allows the Intermediate Pressure (IP) and High Pressure (HP) spools to rotate at their own aerodynamically optimum speeds. This results in fewer stages, higher efficiency, fewer handling aids such as variable stators and bleed valves, a shorter engine and a high standard of modularity which facilitates maintenance.

The shortness of the RB211 engine gives tighter control of tip clearances in the turbo-machinery, providing a lower rate of deterioration in service. The RB211 engine also shows leadership in achieving extended range operations capability.

2.2 TRENT 800 FEATURES

The configuration of the aero Trent engine is similar to its predecessors in the RB211 family (Fig. 2). Its construction makes it readily convertible for ground-based operation as with earlier RB211s.

The aero design includes the hollow titanium wide chord fan pioneered by Rolls-Royce. This fan is replaced by a new 2-stage low pressure (LP) compressor since thrust is not required for

land-based applications. The 8-stage IP compressor is an advanced version of previous RB211 IP compressors. This is the first design of the family having 8 stages. The rig tests have shown it to have competitive surge pressure and efficiency. All previous RB211 HP compressors have had 6 stages, and the Trent is no exception.

The single-stage HP turbine is a development of earlier RB211 HP turbines and has advanced aerodynamics, the latest cooling technology and a high efficiency rotor blade with a cooled shroud. The IP turbine has the latest aerodynamic technology; the rotor is uncooled and made of third generation single crystal material. The Trent 800 5-stage LP turbine is based on the 4-stage Trent 700 design which has demonstrated high efficiency during its development.

Other features of the Trent 800 include an accessory drive through a gearbox at the front of the HP compressor like all RB211s, and squeeze film type bearings.

3. INDUSTRIAL TRENT

The Trent is the latest of a long series of aero engines to be converted to industrial use. Its predecessors include the Olympus, which powers the Concorde, the Spey and at least two versions of RB211.

3.1 CONCEPT

The basic objectives of the Industrial Trent are:

- To develop an industrial gas turbine to deliver 50 MW at a thermal efficiency of 42 percent in simple cycle operation. (The performance of the Trent EconoPac is compared with that of current gas turbines in Fig. 3.)
- To use the experience and technology gained from the development of the RB211 DLE combustor to achieve better than the lowest levels of emissions presently available. Target emissions are 9 ppmvd for both NO_x and CO.
- To develop both 60-Hz and 50-Hz versions with minimum change to components.
- To offer dual fuel capability using natural gas and distillate.
- To design for 50,000 hours service before overhaul, with refurbishment at 25,000 hours.
- To be ready for initial operation in 1996.

3.2 INDUSTRIAL TRENT - DESCRIPTION

The conversion of the aero Trent to industrial form is illustrated in Fig. 4. The aero fan is removed and replaced by a new 2-stage LP compressor. The dual fuel DLE combustor is new. The aero LP turbine is retained in part.

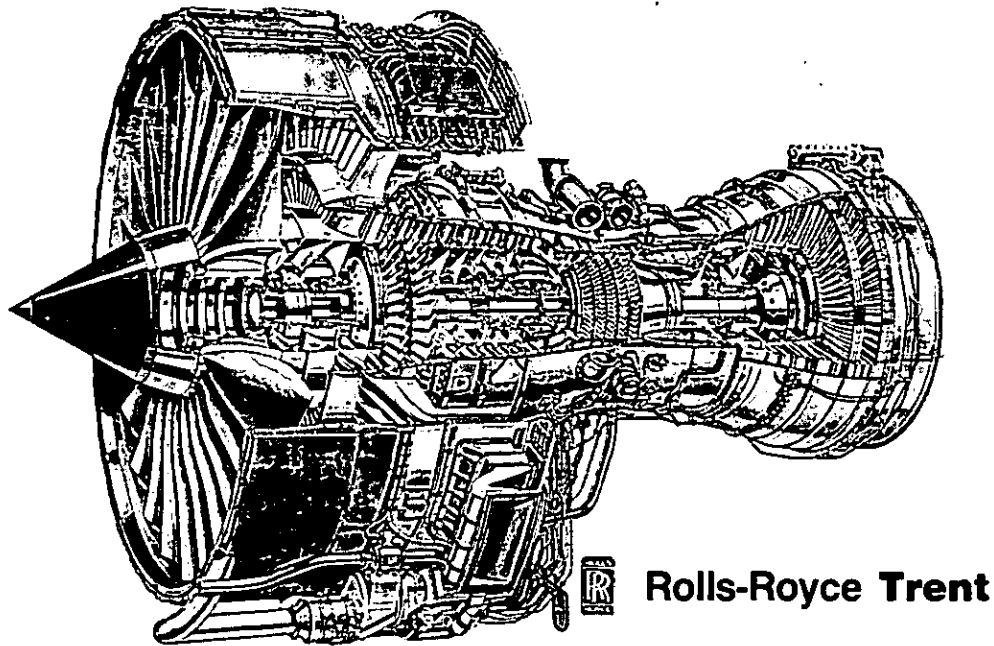

FIGURE 2: The Trent Engine

The industrial Trent thermodynamic cycle, while based on the aero component performance, has been re-optimized for performance, emissions, and engine life for power generation. More details of this are given in Section 6.

The pressure ratio and airflow of the new LP compressor, the operating pressure ratios of the aero IP and HP and the turbine entry temperature (TET) have been chosen to achieve the objectives listed in 3.1 above.

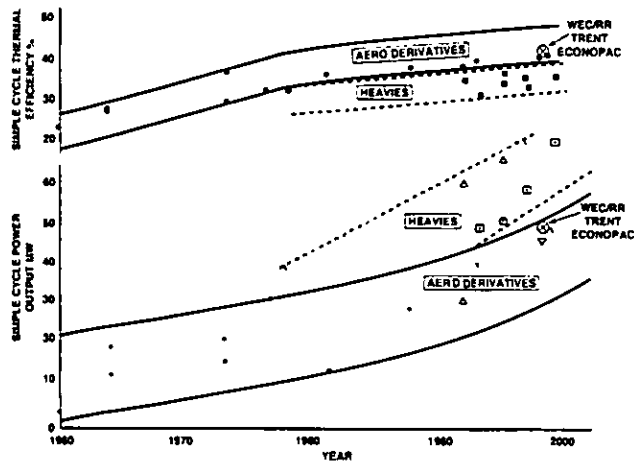

FIGURE 3: Evolution of Heavy Frame and Aero Derivative Gas Turbine Power Generation

3.2.1. COMPRESSORS

The aero fan is replaced in the industrial version by a 2-stage compressor with variable IGVs. It has a similar duty to the root section of the aero fan and hence restores the conditions in the rest of the industrial engine to aero levels. There is a blow-off valve (BOV) between the LP and IP compressors which is opened only during low power operation. The industrial version IP and HP compressors are identical in all respects to the aero version. The IP has 8 stages and 3 rows of variable stators. The HP compressor has 6 stages and no variable stators.

3.2.2 COMBUSTION

In the industrial version the aero combustor is replaced by an advanced Dry Low Emission (DLE) combustor designed for efficient operation with natural gas and distillate. This combustor is described more fully in Section 4.

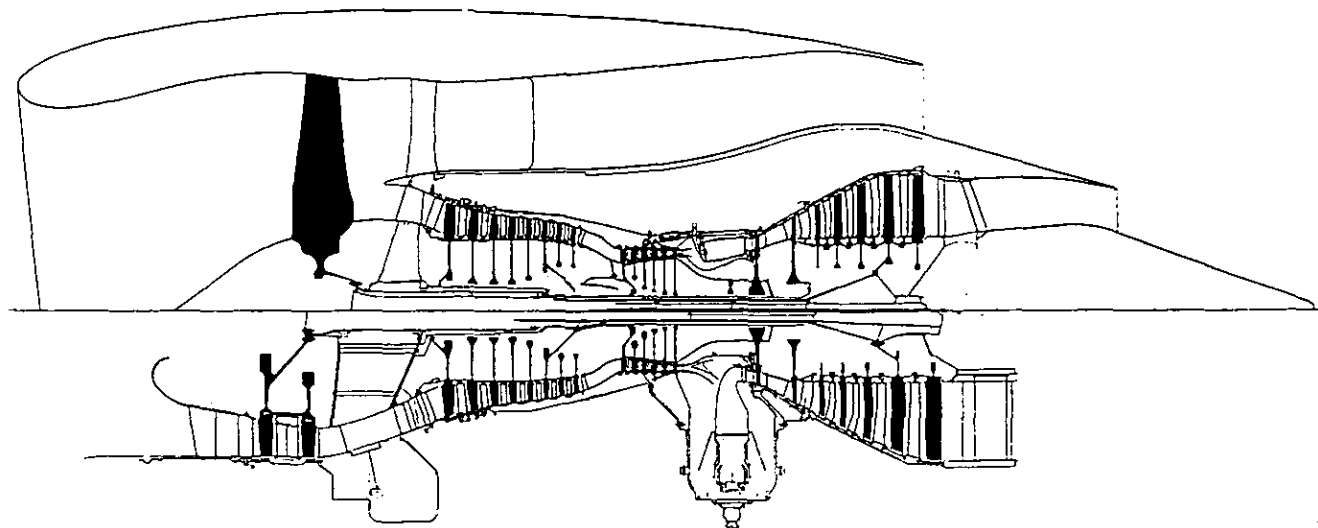

FIGURE 4: Industrial Trent Derivation

3.2.3 TURBINES

The single-stage HP and single-stage IP aero turbines are retained unaltered in the industrial version, except for some minor details in the film cooling pattern of the HP turbine nozzle guide vane (NGV).

The aero LP turbine is the basis of the power turbine for the industrial Trent. It drives both the 2-stage LP compressor and the power shaft. The first 3 of the 5 aero LP turbine stages are retained intact. The 4th and 5th stages are different because of the increased expansion ratio of the industrial version. This increase in expansion ratio is fundamentally due to the need to extract all the available energy for power production in the industrial case, whereas in the aero case, some energy remains to provide thrust. The industrial 4th and 5th stages have a larger gas path area and a lower exit Mach Number than the aero version. The drive to the generator is taken from the rear ('hot end') of the engine.

The exhaust diffuser is supplied with the EconoPac and turns the gases through 90° to deliver the exhaust to an exhaust stack for simple cycle applications, or to a heat recovery steam generator (HRSG) for combined cycle/cogeneration applications.

3.2.4 CONTROL SYSTEM

The EconoPac control system is fully digital electronic. A high degree of reliability, over 99 percent, is achieved by redundancy of software and equipment. A full fault tree analysis of the EconoPac control system has been done to select the optimum redundancy levels.

The EconoPac control system automatically controls all demands placed on the gas turbine such as start and shutdown sequences, load changing, and load trips. It controls the 5 fuel gas flows associated with the DLE combustion system (described

in Section 4) to minimize exhaust emissions using emissions measurements from the exhaust gas. It controls transfers from gas to distillate fuel and regulates the water injection flow rates when operating on distillate fuels.

The engine and control system are designed to accommodate load trips and their attendant impulse effects on the engine shaft.

4. DRY LOW NO_x COMBUSTION

The impetus to reduce exhaust emissions has driven the development of the dual fuel DLE combustor.

The principle used in the Trent industrial machine is that of axially staged lean burn control of NO_x. This principle was described fully by Willis et al (Ref. 1) at the 1993 ASME TURBO EXPO in Cincinnati. Willis's paper described the development of the RB211 (27 MW) DLE combustor, which is the basis of the design for the Trent. A comparison between the aero and industrial Trent DLE combustors is shown in Fig. 5.

The Trent DLE design differs from the earlier RB211 DLE design in certain respects. These changes are essential to meet the Trent requirements of higher power and lower emissions; the Trent combustor also has 100° C (180° F) higher inlet temperature and 10 atmosphere higher inlet pressure. The changes are mainly aerodynamic and consist of a larger combustor volume for lower air velocities, reshaped premix ducts to give uniform mixing in shorter length and a number of detailed changes associated with cooling and the use of distillate fuel as an alternative.

Auto ignition delay times are much shorter than for the earlier RB211 DLE case - about 200 ms compared with about 1 sec. This means that the detailed aerodynamic design of the features downstream of the injectors needs special attention to ensure there are no stagnant pockets of gas and air mixture.

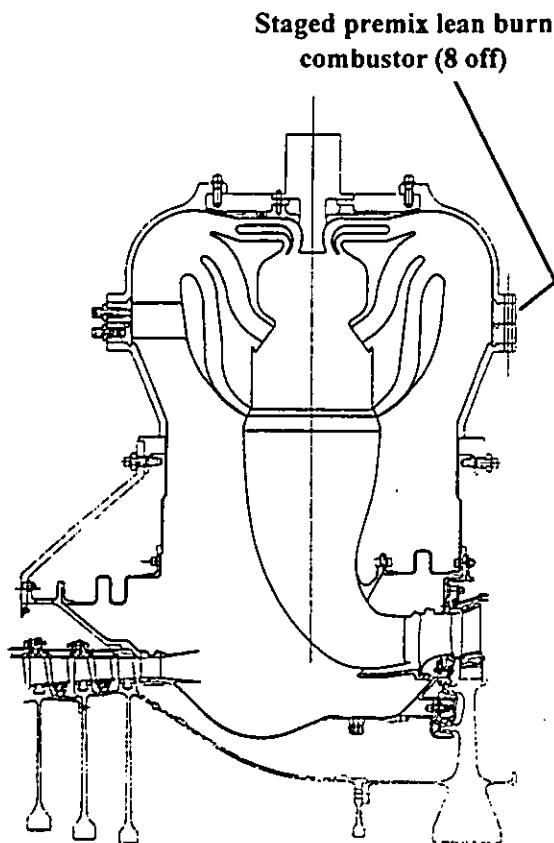

Aero

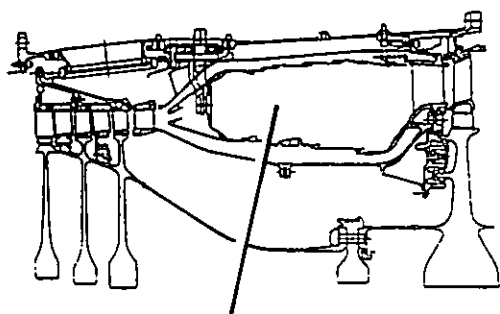

**Single annular combustor
18 off conventional fuel
injectors**

FIGURE 5: Comparative Diagrams of Industrial Trent DLE Combustion System and Standard Aero Combustor

5. PACKAGED FOR POWER GENERATION

The Trent EconoPac is a complete self-contained electric power plant used in either simple cycle or heat recovery applications. The modular design development of the Trent EconoPac includes those pre-engineered options required for broad product application.

5.1 ECONOPAC DESIGN CONCEPT

The objectives for the Trent EconoPac design are to:

- Maximize the degree of factory assembly to minimize field erection time and labor.
- Maximize availability and reliability by designing for removal and replacement of the complete engine within 12 hours after engine cooldown, and removal and replacement of any engine module within 24 hours from cooldown.
- Maximize site arrangement flexibility by providing optional inlet, exhaust and generator terminal configurations.
- Design the EconoPac for outdoor installation and accommodate both 50- and 60-Hz applications with minimal changes in EconoPac configuration.

5.2 ECONOPAC DESCRIPTION

The Trent EconoPac is a complete power generation plant consisting of a turbine skid, an auxiliary skid, an air inlet system, an exhaust system, a combined generator and exciter skid complete with accessories, and the control and electrical systems. Separate skids containing the fire suppression agent and accessories and liquid fuel system are also included. The EconoPac arrangement is shown in Figure 6. A brief description follows.

The turbine and auxiliary skids are both mounted on a single structural baseplate and within an acoustical enclosure which contains normal and emergency lighting. The turbine enclosure contains the Trent engine and its mounting system, the gas fuel system, the engine and gearbox mounted systems, the exhaust diffuser, the inlet bellmouth and plenum, and the intercompressor bleed duct. This enclosure is monitored for fire and fuel gas concentrations. Negative pressure ventilation is maintained within this enclosure. Engine removal facilities are provided to enable rapid removal of the engine from the top of the enclosure.

The auxiliary skid shares the turbine baseplate and is also mounted within an acoustical enclosure. It contains all the standard auxiliary equipment such as the starting system, water wash skid, control system remote I/O, etc. The systems mounted in the turbine and auxiliary skid are all pre-piped and pre-wired to provide a minimum number of interface connections requiring field

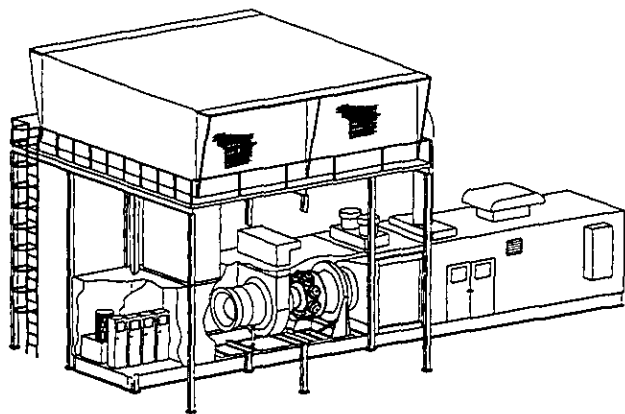

FIGURE 6: Trent EconoPac General Arrangement

assembly. All pressure instruments and gauges, except fuel gas, are terminated at a pressure switch and gauge panel located on the turbine skid.

The Trent EconoPac is designed for a hot end drive configuration. This avoids aero engine shafting limitations and thus provides maximum output in cold ambients and future upgrade potential. A reduction gear is not needed for either 50- or 60-Hz. An additional benefit of this configuration is that the engine mechanical auxiliaries can be mounted at the end of the bedplate, in a separate enclosure, to reduce field construction time and labor. This separate auxiliary compartment provides maintenance access to the mechanical auxiliaries during unit operation to maximize maintainability and availability.

The inlet air system directs air to the inlet bellmouth. The filter may feature either multistage, barrier-type or a self-cleaning, pulse-type filter media depending on specific site requirements. Inlet chilling or evaporative cooling are available options that can be included to enhance site performance. The standard inlet configuration will be a top inlet with an optional side inlet for indoor applications.

A stand-alone exhaust stack is provided for simple cycle installations. Parallel baffle silencer sections are provided for noise reduction to comply with site requirements. The exhaust gases are conveyed directly to a HRSG inlet duct for heat recovery installations.

The standard electrical generator is an open air-cooled (OAC) design with a brushless exciter. Class F insulation is utilized with a Class B temperature rise. Generator line and neutral cubicles, voltage regulator, synchronizer, and relay panels are also provided.

The EconoPac control system will be fully digital electronic and include the operator interface. Control system operation will normally be from the central control room. Motor control centers are also provided for mounting by the customer. The electrical scope can be expanded to include the auxiliary transformer, switchgear (generator breaker and auxiliaries), generator bus, and other equipment as needed. An optional electrical and control enclosure is available for stand-alone sites which do not have an

available central control room.

The Trent engine is shipped separate from its enclosure. This permits building a more compact, light-weight, easily shippable enclosure to the construction site. An additional benefit is that the engine can be shipped when required for startup when construction is complete. This provides the best protection for the engine, reduces interest costs during construction, and minimizes total project lead time from receipt of order.

6. TRENT ECONOPAC PERFORMANCE

6.1 TRENT GAS TURBINE

The base load simple cycle and combined cycle mode operating conditions of the industrial Trent gas turbine are similar to those of the aero Trent. This is because the performance of the industrial version's two stage LP compressor is similar to that of the root section of the aero fan it replaces. This results in the industrial Trent having a thermodynamic cycle characterized by high overall pressure ratio and high thermal efficiency.

Approximate Trent EconoPac Performance (ISO, Sea Level, Base Load, Simple Cycle)

Airflow Rate	350 lb/sec	(159 kg/sec)
Overall Pressure Ratio		35:1
Shaft Power		50 MW
Thermal Efficiency		42 %

6.2 CHOICE OF ENGINE THERMODYNAMIC CYCLE

Studies were performed to determine the optimum choice of thermodynamic cycle. The requirements were:

- Use the aero Trent core (IP and HP) turbo-machinery.
- Design a new LP compressor to replace the fan root.
- Achieve 50 MW at a firing temperature level suitable for low emissions.
- Use the Trent aero LP turbine as the power turbine to the extent possible.
- Achieve maximum commonality of parts for the 60-Hz and 50-Hz versions.

Cycle calculation results are summarized in Fig. 7. Using the aero IP and HP turbo-machinery unaltered means that the required power (50 MW) is obtained over a limited locus of LP compressor pressure ratio and flow. The reason for having a different line for 50-Hz and 60-Hz is that aero LPT capacity varies with LP rpm and this rematches the core slightly.

It was also decided to standardize the LP compressor diameter for the 50-Hz and 60-Hz designs. This meant the LP compressors would have 20% different blade speeds and hence somewhat different design pressure ratios for efficient operation. It was concluded that the only differences necessary between the LP com-

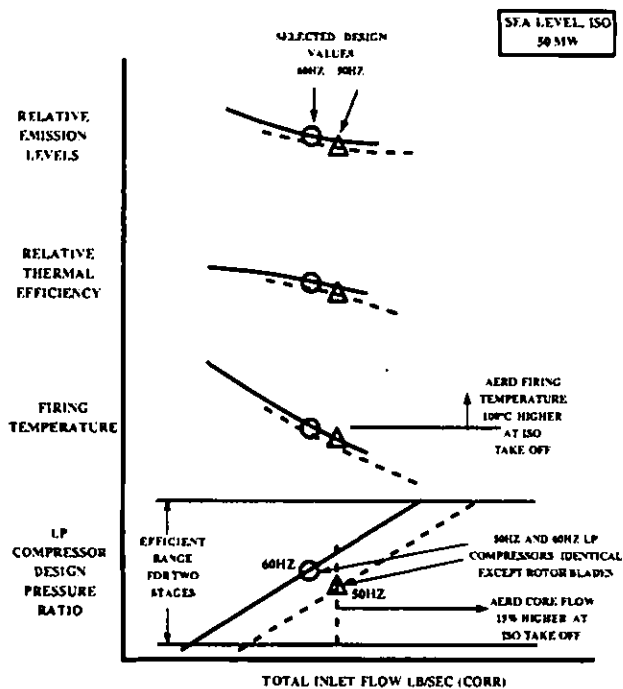

FIGURE 7: Industrial Trent Cycle Selection

pressors for 50-Hz and 60-Hz was a change in rotor blading for both stages. The following LP compressor aero design parameters, which were selected, meet all the objectives of the Trent EconoPac.

LP Compressor Design Parameters, ISO, Base Load

	60 Hz	50 Hz
Flow lb/sec	340	340
(Flow kg/sec)	154	154
Pressure ratio	1.7	1.55
Speed rpm	3600	3000

6.3 LP COMPRESSOR OPTIMIZATION

If the LP compressor had fixed geometry, that is, no variable inlet guide vanes (VIGVs), the operating points on its characteristic would be as shown on Fig. 8., and there would be many parts of the engine operating range where the blow-off valve would have to be opened to prevent surge. This would result in reduced thermal efficiency when blow-off valve operation was required.

The Trent LP compressor is fitted with VIGVs. This optimizes flow at synchronous speeds and greatly increases the operating range where no blow-off is required. The LP compressor operating points are shown in Fig. 9, with VIGVs operating.

The VIGVs have two schedules - one optimized for simple cycle operation and the other for combined cycle operation. The effect of optimization is shown in Fig. 10.

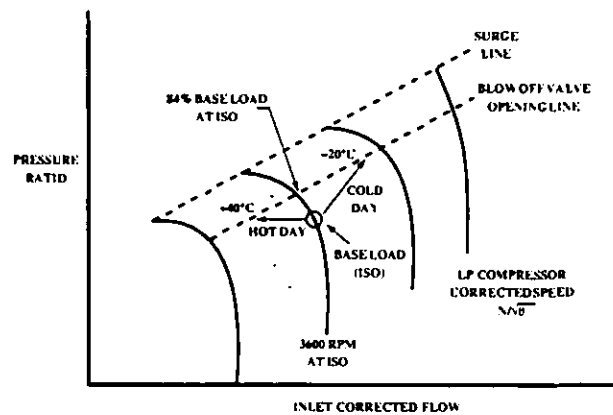

FIGURE 8: LP Compressor Without Variable Inlet Vanes Restricts Range of Efficient Operation

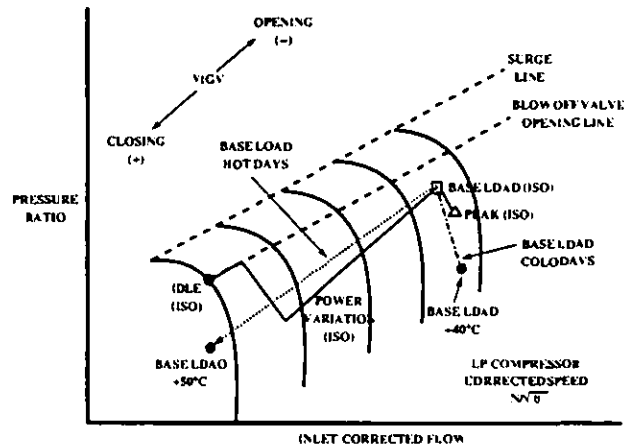

FIGURE 9: LP Compressor With Variable Inlet Guide Vanes Operates Efficiently Over Wide Range

6.4 EFFECT OF AMBIENT TEMPERATURE

The power available varies with inlet conditions, as illustrated in Fig. 11. On warm days above 32°F (0°C), power is controlled to a firing temperature level. On cold days power is automatically maintained constant by the settings of the control system.

The resulting characteristic shows that gains in power may be obtained on hot days by fitting an inlet chiller to lower the temperature of the air entering the gas turbine. There can also be a small net gain in thermal efficiency because the engine operates at a higher pressure ratio when the inlet temperature is reduced at constant firing temperature (see Fig. 11).

6.5 EFFECT OF COMBINED CYCLE

Performance at base load ISO sea level for a typical combined cycle plant is shown in Table 6.1.

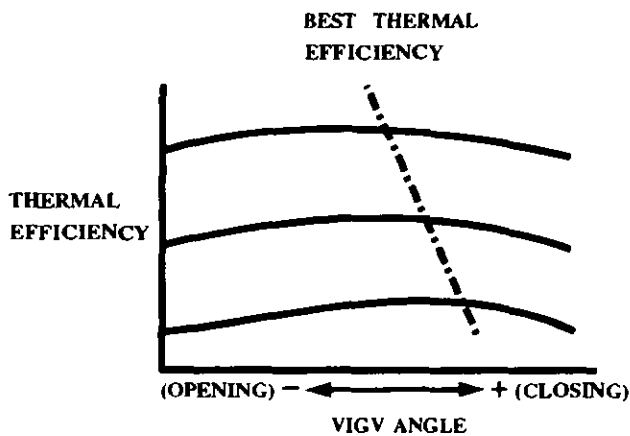
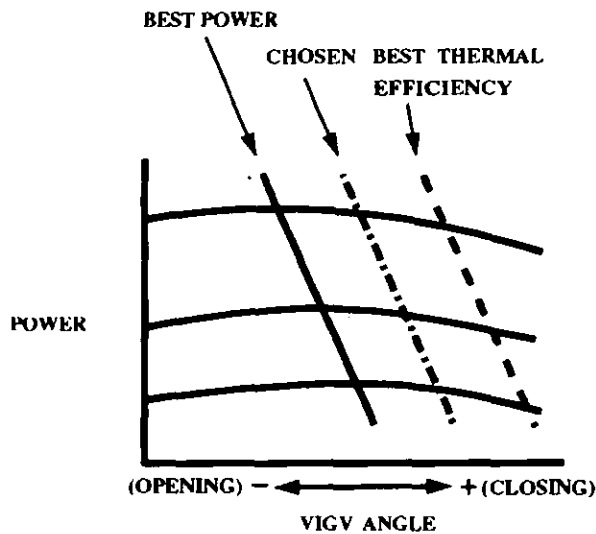

FIGURE 10: Optimization of VIGV Schedule

Table 6.1 Expected Trent Performance (ISO, Base Load, Sea Level)

	Simple Cycle Operation	Combined Cycle Net Output
Total Power (MW)	50	63
Thermal Efficiency (%)	42	52

6.6 FUTURE DEVELOPMENTS

Studies have shown that the Trent EconoPac is capable of being developed to significantly higher powers and higher thermal efficiency. The compressor flow capability, for example, is significantly higher than is being used at current power levels.

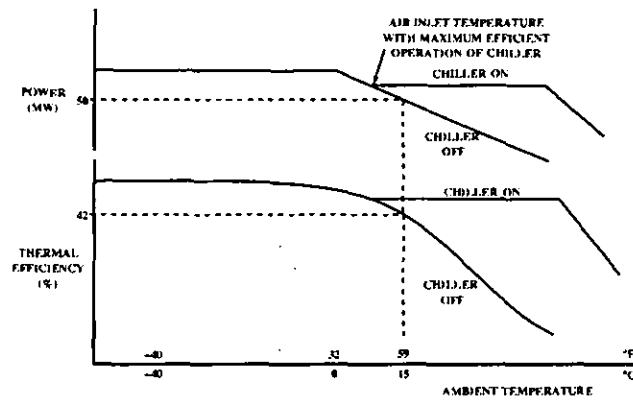

FIGURE 11: Typical Uninstalled Industrial Trent Performance Data

7. DEVELOPMENT PROGRAM

Westinghouse and Rolls-Royce are working closely together to ensure that a fully integrated, highly competitive product will be developed. The Westinghouse EconoPac packaging development program is being done concurrently with the Rolls-Royce Industrial Trent development program. This development partnership will result in an EconoPac which will meet its program-goals for performance, environmental impact, reliability and maintainability, ease of erection, and cost competitiveness.

The overall schedule of the Trent Program is attached (Fig. 12). This identifies major program milestones and shows the concurrent design approach being utilized.

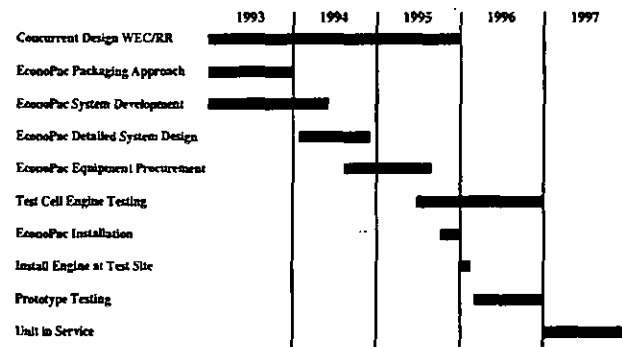

FIGURE 12: Trent EconoPac Development Program

7.1 TRENT ECONOPAC DEVELOPMENT

The major EconoPac development program activities are described below.

The EconoPac packaging approach was established in the third quarter of 1993. This development activity included setting product design criteria and performing design studies to establish the basic configuration of the product.

EconoPac system development includes the design of the auxiliary systems of the EconoPac and the Trent engine. Evaluations will be performed to determine the optimum configuration of the systems to assure that a compact, cost-effective package is produced. Extensive use of RAM analysis techniques will be used to ensure that product reliability goals are met.

EconoPac equipment procurement is scheduled to begin in mid-1994 to support the prototype testing schedule requirements.

7.2 COMPONENT TESTS

The Trent EconoPac engineering program includes aerodynamic testing of key gas turbine components and testing of a single chamber of the combustor operating at full pressures and temperatures. On and off engine auxiliary component testing will also be performed to ensure that the EconoPac can successfully support the prototype testing program. Functional tests include lubrication systems, starting and ignition systems, fuel systems, and control and electrical tests.

7.2.1 AERODYNAMIC RIG TESTS

Aerodynamic testing of a model of the inlet will be performed to verify the pressure loss and velocity profile at the entry to the LP compressor. Aerodynamic testing of the exhaust diffuser-model will be performed to minimize pressure loss and develop the most compact cost effective diffuser and EconoPac package design.

A quarter-sized model of the inter-compressor duct with its blow-off valve (BOV) has undergone aerodynamic testing to optimize the design of the valve system and to verify the pressure profiles at LP compressor outlet and IP compressor inlet. Particular attention has been given to obtaining smooth duct flow and a low circumferential pressure variation in the duct, at maximum bleed conditions, because the collector plenum is asymmetric.

7.2.2. COMBUSTOR RIG TESTS

The overall combustor test program is a logical sequence of rig test programs in which the results from each test are designed to modify the subsequent test programs. The culmination of this program is the verification of emissions and durability targets of a single combustor. This testing will be performed at full pressures and temperatures for both natural gas and distillate fuels.

The first program is a series of low pressure flow visualization tests on elements of the combustor, namely the diffuser, the pre-mix channels, and the discharge nozzle. This program commenced in August 1993.

Following this, flow visualization tests on a 1.5 times linear scale model of a single combustion chamber are aimed at optimizing the overall aerodynamic design to obtain smooth stable air feed to the pre-mix ducts, good mixing in the pre-mix ducts, and uniform flow distribution at entry to the downstream turbine system. This program started in November 1993.

The culminating rig test program is a full combustion test on a single chamber at engine pressure and temperatures. This will

verify startup stability, fuel switching between gas and distillate, emissions and durability. The test program starts in August 1994.

7.3 TEST CELL ENGINE TESTING

Engine verification and certification tests of the gas turbine will occupy parts of 1995 and virtually all of 1996.

Full engine testing will begin in mid-1995. This program places the non-aero parts on test for the first time. Verification work must be done on emissions (albeit short of the full combustor conditions of the complete engine), aerodynamics and the control system. It will be possible to measure a significant portion of the compressor map during the testing, in spite of not being able to develop power beyond idle, by using the BOV and a special IGV schedule.

7.4 ECONOPAC INSTALLATION

EconoPac installation will commence in late 1995. The complete EconoPac (less the Trent engine) will be erected at a customer test site prior to arrival of the prototype engine. This will permit the Trent engine testing to begin promptly after its shop tests are completed.

7.5 PROTOTYPE TESTING

Prototype testing will be performed on one or more customer sites from January 1996 into December 1996. This testing program will involve extensive testing of the Trent EconoPac and its systems in a power generation environment. Combustion system emissions levels and durability, in an actual engine installation, will be confirmed across the ambient temperature and turbine power range.

Measurement of the LP compressor characteristics, LP turbine performance and control system validation will also be completed across the full range of operating conditions. An acoustic testing program will be conducted to map the acoustic performance of the engine, generator, EconoPac subsystems, as well as the complete EconoPac. Durability will be tested and full performance measurements made.

7.7 CERTIFICATION

The first Trent EconoPac is expected to enter commercial operation near the end of 1996. Full certification of the Trent EconoPac, at full production performance and emissions levels, is planned for January 1997.

8. COMBINED CYCLE COGENERATION APPLICATIONS

The Trent EconoPac can be applied to combined cycle and cogeneration applications by the addition of a HRSG and appropriate balance of plant equipment. The Trent combined cycle will operate efficiently over a wide ambient temperature range from a nominal -40°F (-40°C) to 121°F (+50°C) as shown in Figure 11.

This characteristic of the Trent EconoPac maximizes annual power generation and efficiency.

9. CONCLUSIONS

This paper describes the 50 MW Trent EconoPac which is powered by an industrial version of the Trent 800 aero engine. This product is currently under development and is scheduled for initial commercial operation in 1996. The Trent EconoPac can provide a net combined cycle output of 63 MW at 52 percent cycle efficiency.

10. ACKNOWLEDGMENTS

The authors acknowledge the permission given by the Directors of Rolls-Royce plc and the Westinghouse Electric Corporation to publish this paper.

Both authors gratefully acknowledge the assistance of their colleagues in gathering information and preparing material.

REFERENCES

1. Willis, J. D.; Toon, Ian J.; Schweiguer, Tom; and Owen, David A.; May 1993, "Industrial RB211 Dry Low Emission Combustion" ASME 93-GT-391.