

Why applying THP on waste activated sludge makes sense: Psyttalia – Athens case study

D. Zikakis^a, J. Chauzy^{IWA}^{b,*}, I. Droubogianni^a and A. Georgakopoulos^a

^a Aktor S.A., Athens, Greece

^b Cambi AS, Asker, Norway

*Corresponding author. E-mail: julien.chauzy@cambi.com

Abstract

In order to improve the energy footprint of Psyttalia wastewater treatment plant (WWTP) in Athens, the application of a thermal hydrolysis process (THP) was preferred to the option of constructing additional digesters. Since August 2015, approximately half of the generated waste activated sludge (WAS) has been treated by a Cambi B6-4 system, while the thickened primary sludge (PS) is by-passing the THP and is mixed with the hydrolysed WAS before entering the 4 digesters. The 4 other conventional digesters have treated the remaining sludge. The dewaterability of the mixed digested sludge has significantly been improved from 22% dry solids (DS) before THP installation, up to 31% DS after THP installation. This is providing substantial reduction of energy use and cost savings at the sludge drying plant of Psyttalia. In addition, biogas generation and digester efficiency (VSR) have been increased.

Key words: anaerobic digestion, energy management, thermal hydrolysis

INTRODUCTION

The wastewater treatment plant of Psyttalia is the final recipient of domestic sewage and pre-treated industrial wastewater for the greater Athens area in Greece, receiving an average wastewater flow of 730,000 m³/d, with a biological treatment capacity of 3,500,000 Population Equivalent. The plant's wastewater treatment line consists of pre-treatment facilities, primary sedimentation and biological treatment. Secondary treatment is facilitated by 12 activated sludge tanks (bioreactors) with pre-anoxic denitrification for nitrogen removal. The total volume of the activated sludge bioreactor tanks is approximately 300,000 m³. Secondary clarification takes place in 64 rectangular final settling tanks (Gould II type) with an approximate effective surface of 52,000 m².

The Psyttalia WWTP was constructed in separate implementation phases. The first (A) phase, which was finalised in 1994, facilitated the primary treatment of the incoming wastewater loads and the stabilization of the produced Primary Sludge (PS) via four mesophilic anaerobic digesters (10,000 m³ each). The plant was upgraded in 2004 with the construction of the second (B) phase treatment facilities, which incorporated additional treatment stages in order to comply with EU Directive 91/271. Phase B included secondary treatment, with the installation of the biological treatment stage for the wastewater line (primary effluent lift pumping station, bioreactors, final settling tanks, process water disinfection etc), and mechanical thickening for the waste activated sludge (WAS) as well as four additional digesters (10,000 m³ each) for the stabilization of the resulting quantities of PS and WAS and a new dewatering installation for the sludge line. Additional expansion works took place in 2007 and 2008 that include the installation of a Thermal Drying Plant (TDP) for the dewatered sludge (nominal capacity 8625 kg H₂O evap/h, for each line, with four lines in total) and the construction of additional cogeneration facilities with biogas and one with natural gas.

Due to that staged construction, the plant consists of two parallel sludge treatment lines with mesophilic anaerobic digesters. Each line has four 10,000 m³ digesters that originally treated a mixture of thickened PS and WAS. The PS passes through strain press fine screens and is thickened in picket fence gravity thickeners, whereas WAS is thickened by gravity belt thickeners. Digested sludge is dewatered by decanter centrifuges and is finally dried in four thermal rotary drum drying lines to a concentration of >92% dry solids (DS). The generated biogas from the digestion process is used primarily as fuel (powering) for the sludge drying process and the remaining biogas is used at the cogeneration plants to produce electricity.

PROCESS OBJECTIVES AND THE RATIONALE BEHIND TREATING ONLY WAS BY THERMAL HYDROLYSIS PROCESS

The main objective set in 2014 for the O&M contractor, by the plant owner EYDAP was the reduction of the overall energy consumption of the Psyttalia WWTP. Focused on improving the energy footprint of the plant, and in order to meet the contractual energy conservation target, the contractor of the plant, AKTOR S.A., implemented a series of process modifications:

- Enhancement of volatile solids destruction and biogas generation at the anaerobic digestion process by applying WAS-only thermal hydrolysis
- Reduction of heat energy requirement at the drying plant by reducing the volume of water that needs to be evaporated, due to the increased sludge dewaterability from the application of the thermal hydrolysis process (THP) (Barber *et al.* 2012)
- Recovery of heat energy from various sources of the WWTP and the integration of the heating water network. Wasted heat from the coolers of the biological treatment blowers and the combined heat and power (CHP) exhaust gas streams were recovered and utilized for digestion heating
- Steam generation from heat energy recovery of the CHP exhaust stream
- Installation of a hydroelectric power generator at the effluent of the WWTP
- Installation of an integrated power management, monitoring and auditing system
- Replacement of key equipment with new for process optimization and energy conservation

An integral part of that energy conservation initiative was the application of thermal hydrolysis for treating approximately half of the generated WAS stream of the Psyttalia WWTP. Alternative plans to implement thermal hydrolysis at Psyttalia WWTP included the enhancement of the conventional operating scheme by the construction of two additional mesophilic anaerobic digesters.

This WAS-only configuration is used on other plants, for instance at Long Reach, UK (Shana *et al.* 2013) and Hengelo, the Netherlands (Oosterhuis *et al.* 2014). The process is similar to the already established THP sludge pre-treatment for anaerobic digestion (Bougrier *et al.* 2006; 2007) but involves only the thermal hydrolysis of the thickened WAS stream. Thickened primary sludge is then mixed directly with the hydrolysed sludge prior to entering digestion. As opposed to traditional THP configurations, the selection of the WAS-only treatment scheme leads to a lower capital and operational cost investment, which includes the selection and installation of a smaller THP plant, smaller pre-dewatering and steam generation plants, reduced demand for steam generation and reduced polymer consumption. Additionally, the thickened PS sludge stream now acts as a cooling medium for the digester feeding stream and hence smaller cooling equipment can be selected (or even no equipment at all).

Main disadvantages, as opposed to the full treatment of the mixed sludge in the THP, include the reduction of the anticipated performance benefits of the anaerobic digesters, the reduction of the volumetric volatile solids (VS) load to the digestion and the inability to produce a final cake that is pathogen free. However, in plants where the end use of the dewatered cake is not for agriculture and relies on either drying or incineration, the latter disadvantage is not relevant. For WWTP plants

such as Psyttalia, where the dewatered cake is finally dried and shipped off for incineration at cement kilns, the benefit of the WAS-only option, and especially the high level of dewaterability of the digested sludge, is significant. Higher dewaterability (Higgins *et al.* 2005; Panter 2013) means reduced evaporation capacity requirement at the drying plant, which translates directly into fuel reduction. By accounting for the fact that digested primary sludge can already be dewatered to a higher degree than digested WAS, or a mixture of digested PS and WAS (Metcalf & Eddy 2002), the dewaterability of the THP WAS-only digested mixture can be comparable to that of the fully hydrolysed digested mixture.

At the time of planning, and before the installation of the THP, anticipated performance figures included the increase of dewatered sludge concentration from 22% to at least 28% for final dewatered cake dry solids, an increase in biogas generation by 15% and an increase in VS reduction from the already measured values of 45–46% for conventional digestion, to in the range of over 52%. These figures were supported by bench pilot experiments and analyses made specifically for Psyttalia WWTP by Thames Water in cooperation with CAMBI, where thickened PS and WAS samples were collected and sent regularly for feeding a small-scale pilot THP rig and an array of Chemostat digesters. In addition, analysis of dewaterability potential was conducted by KB Kopp laboratories (Kopp & Dichtl 2000).

A first train of THP, a Cambi Thermal Hydrolysis B6-4 system, was installed in 2015 as pre-treatment (thermal hydrolysis being 30 min at 165 °C) of the 4 (B) phase digesters over the 8 existing digesters (10,000 m³ each) (Figure 1), the other 4 (A) phase digesters being still used as conventional mesophilic digesters. Additional auxiliary units included the installation of two pre-dewatering decanters, which receive part of the thickened WAS from the gravity belt thickeners and dewater the sludge stream before it is treated in the THP. The steam required for the operation of the THP is produced at a new hybrid steam generator that utilizes primarily the recovered heat energy from the CHP exhaust gas stream.

The design basis for the WAS-only THP treatment line B (phase) included the installation of a Cambi Thermal Hydrolysis B6-4 system for treating 42.5 tons of pre-dewatered WAS sludge (12% to 16.5% in DS concentration). The loading ratio between the hydrolysed WAS stream (kg DS) and the thickened PS stream (kg DS), at the inlet of the anaerobic digesters, was 40% and 60% respectively. The total design load for the four THP digesters is 106 tons DS/d of sludge with an Organic



Figure 1 | Aerial view of the THP plant (bottom) and 8 mesophilic anaerobic digesters at Psyttalia WWTP.

Loading Rate (OLR) of approximately $2.1 \text{ kgVS/m}^3\cdot\text{d}$. The remaining amounts of thickened WAS and PS sludge (of approximately the same quantity) are fed to the four conventional mesophilic anaerobic digesters (CMAD) of the parallel A (phase) sludge line. The six dewatering decanters were separated into two groups, with each group receiving the digested sludge amounts of the two respective lines.

A new dewatering decanter was also replaced with a new GEA Westphalia CF7000 separator for process optimization. The design steam requirement for operating the THP plant is approximately $2.2 \text{ m}^3 \text{ H}_2\text{O/h}$ (for WAS concentration of 16.5% DS at the inlet of the THP). The current wastewater and sludge treatment schemes of the Psytalia WWTP, after the integration of the THP unit with the B phase sludge treatment line, can be summarized in Figure 2.

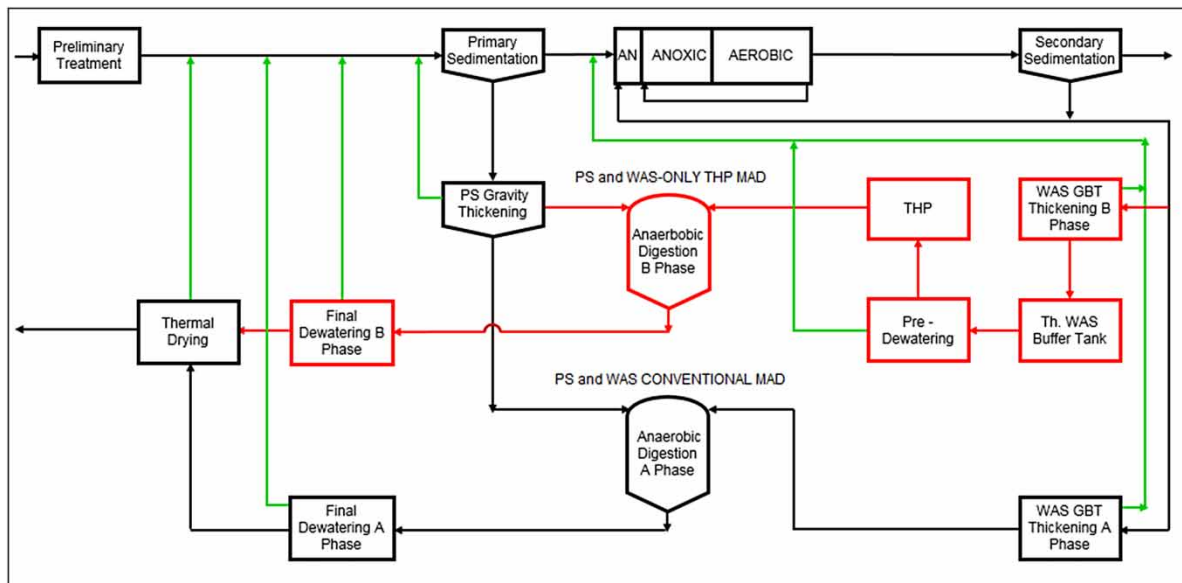

Figure 2 | Simplified flow diagram of the wastewater and sludge treatment lines of Psytalia WWTP. The WAS-only treatment sludge line is highlighted in red.

OPERATIONAL PERFORMANCES

Anticipated performance figures included the increase of VS removal in the range of over 52%, an increase of biogas generation by 15% and an increase in dewatered sludge concentration from 22% to at least 28% for final dewatered cake dry solids. Process performance for anaerobic digestion is assessed for the period from May 2016 after the introduction of hydrolysed WAS in the system, when normal operation was assumed with design OLR values, until March 2017. The findings are compared with the process performance figures of the period August 2014 to June 2015, before the operation of the THP. That specific period was selected as being more representative, because just before August 2014 the 'B phase' digesters were evacuated in series and cleaned of debris and accumulated grit as part of a scheduled maintenance plan.

Volatile solids reduction

Figure 3 depicts the calculated VS reduction percentages (Van Kleeck, moving average) for the respective periods of August 2014 until June 2015 just before the operation of the THP and May 2016 to March 2017 after the introduction of hydrolysed WAS. Average OLR of the former period was in the order of 2.07 kgVS/m^3 , similar to the design loading value of the THP process scheme. It should be noted that the WAS-only OLR applied at Psytalia is quite low and could be higher, as

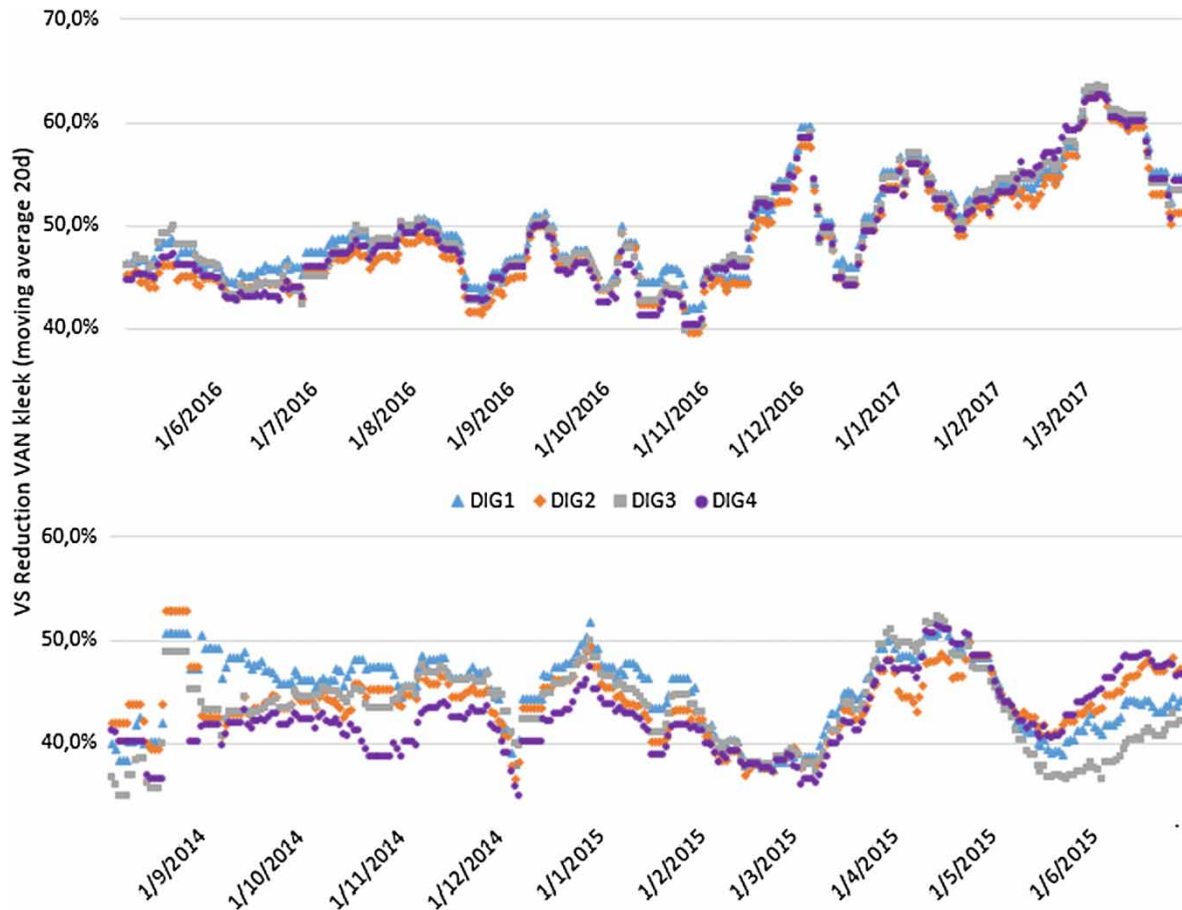

Figure 3 | Calculated VS reduction (Van Kleeck) for periods before (8/2014–7/2015) and after (5/2016–3/2017) the operation of the WAS-only THP.

the intention at Psytalia was not to increase the digestion capacity but to decrease the WWTP power consumption. The average VS reduction for the former period was in the range of 45%, whereas the calculated percentage for the period after the operation of the THP varied from around 45% during the first months of stable operation to over 60% in the later months.

It should be noted, however, that the amount of hydrolysed WAS varied significantly during the operating months (May 2016–March 2017), primarily due to a design limitation that involved the temperature regulation of the anaerobic digesters' feeding stream. The design configuration of the THP sludge treatment line of Psytalia WWTP did not include a cooling system for the hydrolysed WAS stream, as wastewater temperature was expected to be lower. Instead, the non-hydrolysed thickened PS stream acts as the cooling medium when mixed with the hydrolysed WAS stream before entering digestion. As a result, the measured temperature at the digester feeding stream became the deciding factor in selecting the appropriate ratio between hydrolysed WAS and thickened PS flows and, by extension, loads at the feed. This limitation became more evident during the warmer months, when the elevated primary sludge temperatures required increased amounts to be mixed at the feeding stream at the expense of the hydrolysed WAS stream. Figure 4 depicts the variation of the DS load ratio of hydrolysed WAS to total DS load at the digester feed in respect to the monthly average temperature values of the thickened primary sludge stream.

The need to maintain and respect the design OLR of the THP digesters, the limited availability of PS especially during the summer months and the necessity to support appropriate loading rates at the remaining four conventional MAD digesters of the A phase led to a varied hydrolysed WAS/total feed loading ratio. If that monthly variation is projected with the calculated monthly average VS

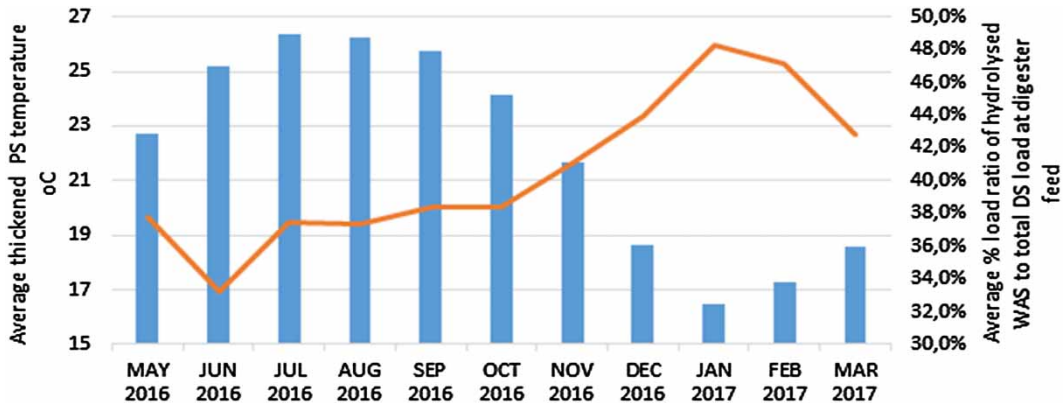

Figure 4 | DS load ratio of hydrolysed WAS to total DS load at digester feed and thickened PS stream temperature.

reduction values (Figures 5 and 6), the increased VS reduction percentages of the later months is probably related to the increased load percentage of hydrolysed WAS (HWAS) introduced in the digesters (or attributed to the gradual adaptation of the digestion process).

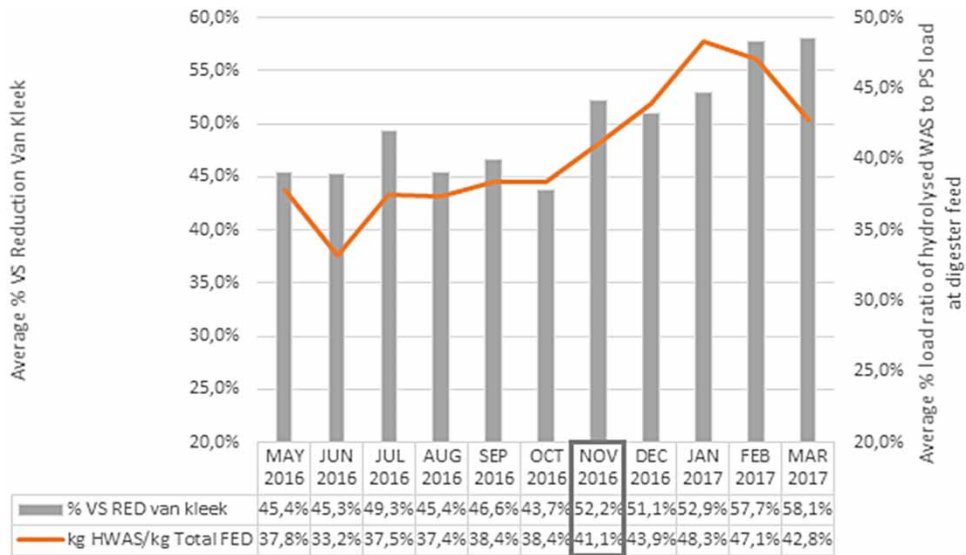

Figure 5 | DS load ratio of hydrolysed WAS to total DS load at the digester feed and calculated VS reduction.

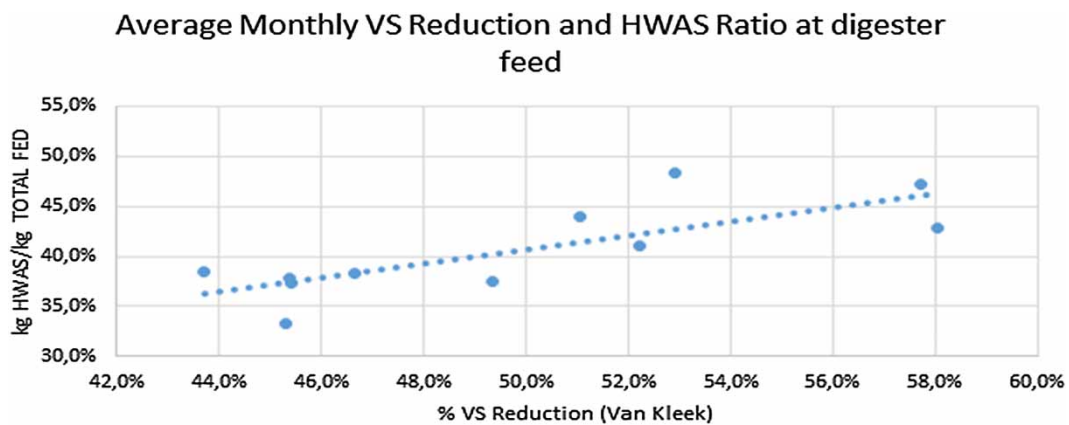

Figure 6 | Relationship of the DS load ratio of hydrolysed WAS to total DS load at digester feed and calculated VS reduction.

It should also be noted that higher percentages of hydrolysed WAS (HWAS) loads, for given OLRs, also signify higher retention times in digestion as HWAS streams have higher DS concentrations than thickened PS streams. The design ratio value of 40% WAS to 60% PS was satisfied after November 2016 with corresponding VS reduction values close to 52%.

Biogas production

Figure 7 depicts the daily average specific biogas production values in terms of $\text{Nm}^3/\text{ton DS fed}$ for the four B phase digesters for a period of over two years. Several days have been omitted, which correspond to the four months during digester conditioning (February 2016–April 2016) and to the early disturbances of October 2015.

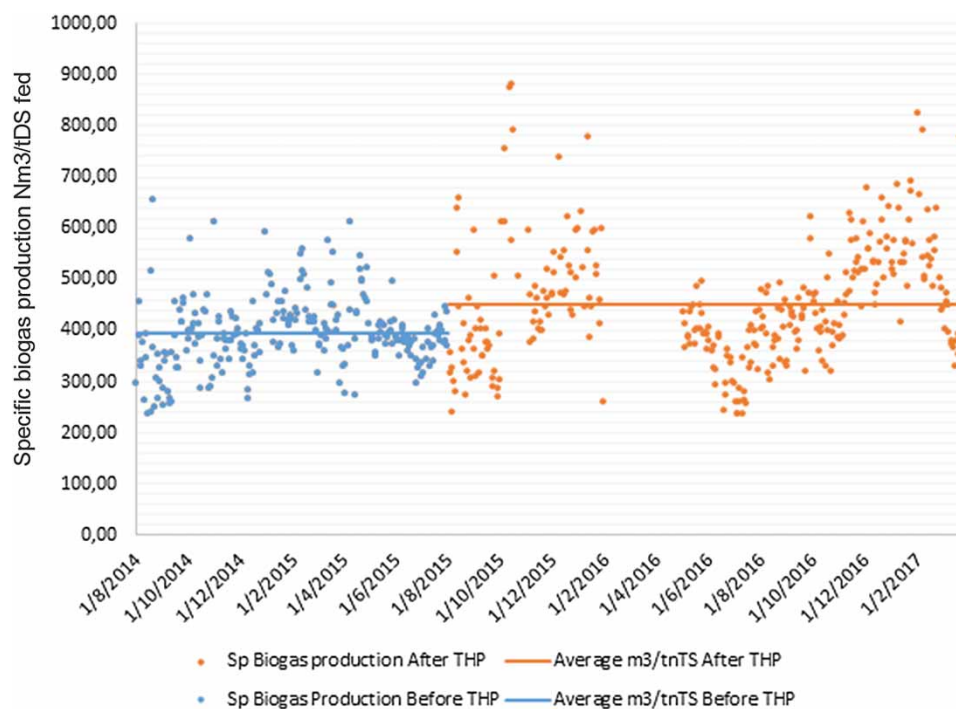

Figure 7 | Calculated specific biogas production in $\text{Nm}^3/\text{ton DS fed}$ for periods before (8/2014–7/2015) and after (8/2016–3/2017) the operation of the WAS-only THP.

The average value of specific biogas production for the yearly period of August 2014 to July 2014, before the installation and operation of the THP plant, is calculated as $393 \text{ Nm}^3/\text{ton DS fed}$. After the introduction of hydrolysed WAS in the system, the specific biogas value saw a significant increase especially after November 2015. The corresponding average value for the latter period, after the introduction of hydrolysed WAS in digestion, was $452 \text{ Nm}^3/\text{ton DS}$, which is approximately a 15% increase, close to the expected value.

For the latter months of stable operation, from May 2016 to March 2017, the specific biogas production values follow closely the volatile solids (VS) reduction increase. After November 2016 when the VS reduction values increased to over the target value of 52%, specific biogas production daily values were frequently calculated to be over $500 \text{ Nm}^3/\text{ton DS}$.

Dewaterability

After the operation of the THP in August of 2015 and the introduction of hydrolysed WAS in the four 'B phase' digesters, the sludge treatment process was separated into two distinct lines. Three of the

final dewatering decanters (6 in total) received the mixed digested sludge from the conventional digestion treatment line (CMAD), and the remaining three decanters, including a newly installed GEA Westphalia CF7000 separator, received the mixed digested sludge from the THP WAS-only treatment line (HWAS MAD).

Figure 8 presents the daily measured % DS concentrations of dewatered sludge grab samples, depicted separately for the two different process lines. For the period before the operation of the THP (August 2014 until July 2015), there was no separation between the two treatment lines, as the digested sludge from all eight digesters of the WTPP was mixed prior to dewatering.

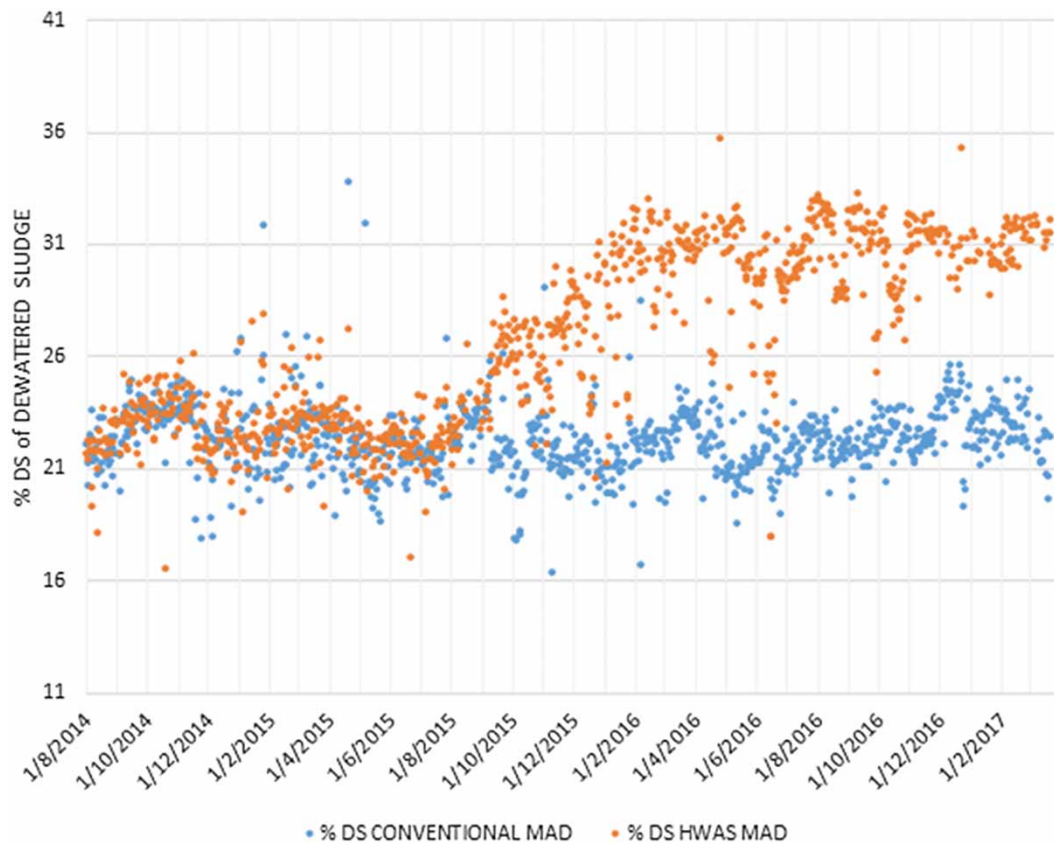

Figure 8 | Dryness in % DS of dewatered digested sludge, for phase A (conventional) and phase B (THP) digesters.

After the separation of the two process lines in August 2015, the dewatered sludge concentration of the THP treatment line saw a gradual % DS concentration increase. The dewatered sludge concentration of the THP digested sludge (mixed hydrolysed WAS and PS digested sludge) was stabilized on February 2016 to approximately 31% DS, whereas the dewatered sludge from the conventional treatment line remained constant and close to the average value of 22% DS. It is also evident that the varied degree of volatile solids destruction throughout the operating months, as described above for digester performance, didn't seem to affect the dewaterability performance of the produced sludge, as the later remained fairly constant after February 2016.

CONCLUSION

The WAS-only treatment scheme of Psytalia WWTP involves the treatment of 50% of the generated WAS loads. The four dedicated digesters of the THP WAS-only line receive approximately half of the

generated sludge quantities of the WWTP, a mixture of thermally hydrolysed WAS and non-hydrolysed thickened PS.

The exclusive treatment of the WAS stream at the THP prolonged the initial ramping-up period as the handling and pumping of the viscous sludge stream required mechanical modifications at the feeding configuration of the THP, especially when operating with high % DS concentrations at the inlet.

Following a process adaptation period due to the increasing ammonium concentrations in the digesters from 1300 mgN/L to nearly 2500 mgN/L, as a post-effect of the enhanced hydrolysis and the higher DS concentration at the feed, and since the successful completion of the commissioning period, the THP plant has operated stably for nearly a year. The following key performance indicators, as measured and calculated during the period of operation (May 2016–March 2017) summarize the benefits of the WAS-only configuration:

- Improved dewaterability from 22% dry solids to 31% (minimum target value of 28%),
- Increased VS reduction from 45% to over 52% (minimum target value of 52%),
- Increased biogas production from approximately 390 Nm³/ton DS fed to 450 Nm³/ton DS fed, 15.4% increase (minimum target value of 15%).

For the Psyttalia WWTP, of particular significance was the increased sludge dewaterability effect as an immediate consequence from the application of the THP. The reduced volume of water at the inlet of the drying plant means that less heat energy is necessary for drying operation. For the drying plant, with a target value of 92% DS at the outlet, the increase of the fed dewatered sludge concentration, from 22% DS to 31% DS translates directly into a 38.2% heat reduction requirement. For the Psyttalia WWTP, where only half of the generated sludge is being treated in the digesters and decanters of the WAS-only line, the overall evaporation requirement at the drying plant is reduced by approximately 86 tons of water per day or in effect by 19.1% in overall heat energy consumption and biogas consumption needs.

If projected to the overall biogas production values at Psyttalia WWTP (for both sludge treatment lines), the reduction of consumed biogas at the drying plant means approximately that 16% of the daily generated amount is now available for other uses. By adding another 7.7% from the biogas production increase at the anaerobic digesters (by considering the biogas increase of 15.4% from the WAS-only treatment line digesters, which receive half of the sludge amounts) the total available biogas is now increased by nearly 24%.

Essentially, by treating approximately only 20% of the generated sludge amounts at the THP (WAS-only THP for half of the total WAS amount and with 40% to 60% WAS and PS respective load ratios), approximately 24% more biogas is now available that may be used at the CHP plant to generate electricity.

More research and observations are to follow in order to further extend our assessment of the WAS-only THP application at Psyttalia. Digester operation is monitored closely on a daily basis in order to identify and understand more accurately the boundaries of the system. Process performance and benefits from the THP treatment are recorded and calculated in order to optimize the operation.

Future plans for the Psyttalia WWTP include the installation of a cooler at the outlet of the THP plant in order to eliminate a substantial limitation in selecting appropriate feeding ratios for the digesters. Plant expansion is also considered, by proposing that the plant owner should invest further in THP technology. Energy reduction benefits are expected to double by treating all of the generated WAS amounts, with the installation of another train of WAS-only thermal hydrolysis.

REFERENCES

- Barber, W. P. F., Lancaster, R. & Kleiven, H. 2012 *Thermal hydrolysis: the missing ingredient for better biosolids?* Water Wastewater Int. Mag. Aug/Sept, 36–38.

- Bougrier, C., Delgenès, J. P. & Carrère, H. 2006 Combination of thermal treatments and anaerobic digestion to reduce sewage sludge quantity and improve biogas yield. *Process Saf. Environ. Protect.* **84**(B4), 280–284.
- Bougrier, C., Delgenès, J. P. & Carrère, H. 2007 Impacts of thermal pre-treatments on the semi-continuous anaerobic digestion of waste activated sludge. *Biochem. Eng. J.* **34**, 20–27.
- Higgins, M., Beightol, S., Mandahar, U., Xiao, S., Hung-Wei, L., Le, T., Mah, J., Pathak, B., Novak, J., Al-Omari, A. & Murthy, S. 2015 Effect of thermal hydrolysis temperature on anaerobic digestion, dewatering and filtrate characteristics. In: *Proceedings of WEFTEC 2015*, New Orleans.
- Kopp, J. & Dichtl, N. 2000 Prediction of full-scale dewatering of sewage sludge by thermogravimetric measurement of the water distribution. *Water Sci. Technol.* **42**(9), 141–149.
- Metcalf & Eddy 2002 *Wastewater Engineering, Treatment and Reuse*, 4th edn. Table 14-2. McGraw-Hill Education, New York, NY, USA.
- Oosterhuis, M., Ringoot, D., Hendriks, A. & Roeleveld, P. 2014 Thermal hydrolysis of waste activated sludge at Hengelo wastewater treatment plant, The Netherlands. *Water Sci. Technol.* **70**(1), 1–7.
- Panter, K. 2013 Thermal hydrolysis, anaerobic digestion and dewatering of sewage sludge as a best first step in sludge strategy: full scale examples in large projects in the UK and Ireland. In: *Presented at 4th Municipal Water Quality Conference*, Sun City, South Africa.
- Shana, A., Fountain, P., Mills, N. & Hunt, P. 2013 SAS only THP with series digestion – more options for energy recovery. In: *Proceedings of the 18th Biosolids & Organic Resources Conference*, Manchester, UK.