

Field-scale anaerobic baffled reactor for domestic wastewater treatment: effect of dynamic operating conditions

S. S. Yenji, G. R. Munavalli* and M. M. Koli

Department of Civil Engineering, Walchand College of Engineering, Sangli, Maharashtra, India

*Corresponding author. E-mail: guru.munavalli@walchandsangli.ac.in

Abstract

A 45 m³/d field-scale anaerobic baffled reactor (ABR) was studied for its performance to remove carbonaceous organic content and suspended solids under a dynamic hydraulic loading rate (HLR) and organic loading rate (OLR). Sludge granulation effect was also assessed with and without sand as a bio-carrier aided with poly aluminium chloride. ABR was subjected to a significant variation in HLR (0.26 to 7.72 m³/m².d) and OLR (0.03 to 8 kg COD/m³.d). Tracer study showed flow-through time was 50% of theoretical hydraulic retention time. The initial compartments of ABR were more effective for the removal of organic carbon. An overall COD_{Total} removal of 60 to 90% was possible for OLR in the range 1 to 8 kg COD/m³.d irrespective of low/high HLR. OLR dominated the performance of ABR compared to HLR. The compartmentalized nature of ABR was visualized through a two-phase system of anaerobic digestion as alkalinity increased while VFA decreased from the first to last compartment even under dynamic conditions. Sludge granulation with sand and PAC increased the size of granule from 629 to 1,471 μm, decreased sludge depth by 20% and enhanced COD_{Total} removal within a month. ABR is sturdy to sustain low/high HLR with low/high OLR conditions without impairing COD_{Total} removal efficiency significantly.

Key words: anaerobic baffled reactor, hydraulic loading rate, organic loading rate, sludge granulation, tracer study

Highlights

- Field-scale anaerobic baffled reactor (ABR) is assessed for COD removal and sludge granulation under dynamic operating conditions.
- The removal of carbonaceous organic matter increases with strength of wastewater.
- The compartmentalized nature of ABR is evident.
- 60 to 90% COD removal is possible.
- Sludge granulation is effective with sand and poly aluminium chloride.

INTRODUCTION

A centralized conventional domestic wastewater treatment system requires large mechanized infrastructure, which is generally higher in initial and recurring costs. Alternatively, decentralized wastewater treatment (DWT) is an appropriate option for developing countries, particularly for isolated residential/commercial/institutional establishment/s (Sathe & Munavalli 2019). The potential benefits associated with DWT include (i) reliability and robustness, (ii) low operational energy, (iii) minimal requirement for highly skilled personnel in operation and maintenance, and (iv) more scope for wastewater reuse. Typically, DWT has primary treatment (screen chamber, and septic tank/settler), secondary anaerobic treatment (anaerobic baffled reactor (ABR)/anaerobic filter) and

secondary aerobic/anaerobic treatment (constructed wetlands) (Bernd *et al.* 2009). ABR has become an essential and integral part of DWT and is regarded as a possible technical solution to the sanitation crisis/challenges due to its low maintenance requirements, simple and inexpensive construction and stable operation (Barber & Stuckey 1999; Pillay *et al.* 2009; Reynaud & Buckley 2015).

ABR is essentially a modified septic tank made up of multiple baffled compartments through which wastewater moves successively upwards. A sludge blanket is formed at the bottom of these compartments due to accumulation of suspended solids and biosolids. The organic solids in wastewater come in contact with this sludge blanket in every compartment and get anaerobically degraded. The upflow movement of wastewater induces an interaction between biomass and substrate inside the compartments (Schalk *et al.* 2019). The dynamic flow conditions maintain this sludge blanket either in packed, fluidized or expanded state. The surface area provided by sludge granules is a key parameter in the degradation process. Further, the compartmentalized nature of ABR helps to decouple hydraulic retention time (HRT) from solids retention time (SRT), thereby resulting in relatively smaller footprint. An overview about basic working, principle of operation, advances in ABR technology and applications for communal wastewater is reported by (Barber & Stuckey 1999; Reynaud & Buckley 2015; Zhu *et al.* 2015).

Since the late 1990s, ABRs have been increasingly applied in communal wastewater treatment and researched at laboratory, pilot and full-scale level in England, South Africa, Germany, India, Indonesia, Nepal, Vietnam, Thailand and China. The effect of organic and hydraulic shock loading rates was assessed for ABRs and stable performance was reported for laboratory scale studies on synthetic wastewater (Hu *et al.* 2006; Liu *et al.* 2007; Krishna & Kumar 2008; Reynaud & Buckley 2015). The applicability of ABR (10 m³/d, 1.2 d HRT) as a high-rate anaerobic reactor was investigated, and was found to be very effective in the removal of organic parameters (Singh *et al.* 2009). Performance data on full-scale ABR implementations are extremely scarce, and existing studies are without exception affected by site-specific treatment-limiting factors hindering the extrapolation of generally valid conclusions. No study linking full-scale plant treatment to hydraulic system load exists to date. The true potential of ABRs needs to be assessed by investigating systems with increased loading. Very little information is available on full or pilot-scale ABR implementations, and most studies are based on laboratory scale research (Reynaud & Buckley 2016). Uyanik *et al.* (2002a, 2002b) reported that an ABR would promote phase separation (compartmentalized nature) and a polymer additive was capable of enhancing granule formation in an ABR fed with synthetic ice-cream wastewater. PVA-gel beads were used as a biocarrier in a lab-scale UASB reactor treating synthetic wastewater composed of corn steep liquor with the aim of evaluating its use as a growth nucleus to enhance granule formation (Wenjie *et al.* 2008).

Dynamic operating conditions can be induced into a DWT if it receives wastewater as and when generated from the source/s by gravity fed system. DWT is located at the ground floor/basement in multistoried building/s and receiving wastewater from the first floor and above is a typical case for such dynamic operating condition. HLR and OLR fluctuate under these dynamic operating conditions. The extent of variation in HLR and OLR depends on the type of establishment and nature of activities generating wastewater. The low HLR conditions lead to high HRT and vice versa. Further, ABR is likely to be subjected to stressed (high loading rates) and relaxed (low loading rates) conditions when both HLR and OLR vary continuously. The effect of hydraulic and organic shock loading on laboratory-scale ABR fed with synthetic wastewater is reported in the literature. The diurnal fluctuations of communal wastewater production or concentration were not taken into account, since all systems were loaded with constant feed flow. These fluctuations may, however, have significant influence on the treatment (Reynaud & Buckley 2015). However, the effect of dynamic operating conditions which lead to continuous variation in HLR and OLR on field-scale ABR has not been reported in the literature. Further, sludge granulation studies with bio-carrier other than PVA-gel beads are not reported on field-scale ABR for domestic wastewater. Thus, the

performance evaluation (with/without sludge granulation) of field-scale (real-life) ABR operated under dynamic conditions is very significant and contributes to the existing knowledge. The present study has addressed the effect of continuously varying HLR and OLR in field-scale ABR on: (i) the removal efficiency of TSS, COD, and BOD; (ii) compartmentalized nature in terms of pH, alkalinity and VFA; (iii) sludge characteristics and depth of sludge blanket; and (iv) sludge granulation with/without sand as bio-carrier aided with poly aluminium chloride (PAC).

MATERIALS AND METHODS

Source of wastewater

The study was conducted in Walchand College of Engineering (WCE), Sangli (latitude 16.8431°N and longitude 74.6012°E) in the state of Maharashtra, India. The city falls in a semi-arid climate zone. The wastewater generated from residences, food courts (mess) and hostels in the campus of WCE was a feed to ABR. Residences and hostels were connected to septic tanks prior to disposal into the treatment system. The contributing components of wastewater included greywater, septic tank effluent and washings from a food court. The significant quantity of flow was from food courts and hostels.

Field scale ABR

A 45 m³/d capacity DWT is being operated in the campus of WCE. The treatment flow scheme of DWT consists of preliminary and three stage biological treatment. Screen chamber is a preliminary treatment. The first stage biological treatment has ABR. The second and third stage systems consist of baffled biorack hybrid constructed wetland (BBHCW) and vertical flow constructed wetland (VFCW) respectively. The schematic and photographic views of field-scale ABR are shown in Figure 1(a) and 1(b). It has six compartments (denoted as C1, C2, C3, C4, C5 and C6) with total volume of 68 m³ and effective depth 2.5 m of wastewater in each compartment. The interconnection between the compartments is through a system of three 150 mm diameter down take pipes. These pipes are arranged in such a way that an upflow is induced in every compartment. Each compartment is provided with a sampling port [shown as circles in Figure 1].

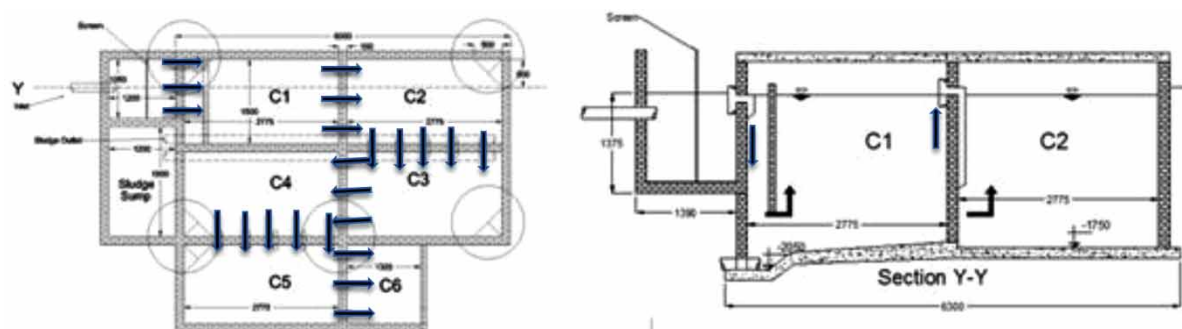

Figure 1 | Schematic plan and section of field-scale ABR.

ABR was operated under dynamic flow conditions as there was no pumping provided and the system was fed by gravity. The flow to the system was monitored during 6:00 a.m. to 6:00 p.m. as the flow contribution was not significant (<500 L/h) after 6 p.m. The volumetric method (collecting and measuring volumes per time period) was used to measure the flow rate. Flow measurements were

recorded at an interval of 0.5 h on all the days in a week. The sampling time and frequency of sampling were decided based on these flow measurements. The wastewater as and when generated flowed continuously into ABR thereby inducing dynamic flow conditions. Thus, HLR [computed as flow rate (m^3d^{-1})/surface area (m^2)] and OLR [computed as flow rate (m^3d^{-1}) x COD ($\text{kg}\cdot\text{m}^{-3}$)/Volume (m^3)] were varied continuously.

The start-up of ABR was an initial step and governed by the characteristics of raw wastewater, organic loading, HLR, OLR, temperature, and the use of seed/inoculum. The presence of septic tank effluent contributed to anaerobic seed/inoculum in the raw wastewater itself. Also anaerobic sludge was collected from a working digester and 20 L of this sludge was added in each of the ABR compartments as an additional inoculum to enhance the process of anaerobic degradation in the start-up phase of ABR. Further, HLR (0.5 to 1.5 $\text{m}^3/\text{m}^2\cdot\text{d}$) and OLR (0.10 to 0.5 $\text{kgCOD}/\text{m}^3\cdot\text{d}$) were regulated to induce conducive conditions for early start-up by using by-pass arrangement to ABR. The presence of anaerobic culture in septic tank effluent, externally added seed/inoculum, operation under lower OLR and HLR, and external temperature (ambient temperature 35 to 40 °C) contributed to early start-up of ABR. The start-up of anaerobic treatment was monitored by assessing the performance of ABR for COD removal. It was observed that anaerobic activity started with consistent COD removal efficiency of more than 50% after 15 days of operation.

Tracer study

Tracer study was conducted on ABR to estimate actual hydraulic retention time (HRT) as ABR was subjected to dynamic flow conditions. Fluoride was used as a tracer and the study was conducted twice. The raw wastewater had no fluoride in it and hence was used as a tracer. A standard sodium fluoride solution of 2 mg/L was prepared and 5 L of the solution was injected in the inflow to ABR as a slug. The concentration of fluoride was measured using the SPANDS method through a UV spectrophotometer (set at 570 nm wavelength). Fluoride of 0.33 mg/L and 0.020 mg/L was observed at the inlet and outlet respectively immediately after the addition of fluoride into the feed. Subsequently, samples were collected from the ABR outlet after every 0.5 h interval and analyzed for fluoride. Tracer response curve (TRC) was plotted and actual mean HRT was determined. The actual HRT was determined by using the formula:

$$\text{Actual mean HRT (min)} = \frac{\sum C_i t_i \Delta t}{\sum C_i \Delta t} \quad (1)$$

where, t_i = time of i^{th} sampling (min), C_i = fluoride concentration at t_i (mg/L) and Δt = time interval (min).

Sampling and characterization of wastewater

The samples were collected from the inlet and all compartments. Three sampling periods, viz. 8.30 to 10.30 am, 1.30 to 3.30 pm and 4.30 to 6.00 pm were identified based on diurnal flow monitoring. There was no significant flow variation within these identified periods. A depth sampler was used to collect samples from ABR compartments. A mixed sampling method was adopted. Samples were collected every 0.5 h and all four samples within this period were mixed and referred to as mixed samples. The sampling was done on alternate days and there were 85 monitoring days in total during the study period of six months. The wastewater samples were analyzed for the parameters pH, BOD, COD, alkalinity, volatile fatty acids (VFA) and total suspended solids (TSS) by referring to *Standard Methods for the Examination of Water and Wastewater* (APHA 2012).

Sampling and characterization of sludge

The sludge sampling and its characterization were carried out during the study period. Sludge samples were collected at a depth of 2.3 to 2.8 m (which corresponds to the sludge zone in ABR compartments) using a depth sampler. Sludge depth was measured by a specially developed sludge depth measurement rod. It was made up of a bamboo painted a white color and wrapped with white Velcro tape throughout its height. The purpose of using the Velcro tape was that the surface roughness enables sticking/coating of sludge solids easily and thereby different intensities blackish color can be visualized on this rod. The sludge depth in the ABR compartment was measured by inserting this rod vertically into each compartment, holding it in that position for 10 minutes, gradually removing the rod and measurement. Then, the depth to which the coated suspended solids were attached onto the Velcro tape of the rod was measured and expressed as sludge depth in that compartment. The depth measurements were carried out during minimum flow conditions as low turbulence prevails during that time enabling the measurement of the compact depth of the sludge blanket. A parameters pH, total solids (TS), volatile solids (VS) and fixed solids (FS) were used to characterize the sludge. A morphological study of the sludge was also carried out in terms of surface texture/sludge structure (scanning electron microscopy (SEM)) and size (MALVERN particle size analyzer based on wet dispersion method). The sludge sampling, characterization and depth measurement was done once a week. SEM studies were conducted before and after the application of granulation techniques. Particle size analysis was done after granulation.

Application of sludge granulation techniques

The process of sludge granulation was carried out by using sand and polyaluminium chloride (PAC) as bio-carrier and binder/flocculant respectively. Sand was chosen owing to its inert and heavy nature whereas PAC enhances adhesion of sludge particles onto the sand surface. The effective size of sand used was 50 to 90 μm with specific gravity of 2.65. The last ABR compartment was chosen for the sludge granulation study as the possibility of washout of sludge solids was greater in this compartment at peak flows. Slurry was prepared using 37 L of water with 370 g of PAC and 2.2 kg of sand added. It corresponds to a dosage of 6 g sand/L, and 1 g PAC/L. This slurry was applied as a slug directly into the sludge zone in the last compartment with a feeding pipe once a week for three successive weeks. The dosing was carried out at the minimum flow condition for enhancing contact time between sludge solids, sand and PAC. This also eliminates the possibility of washout of sludge solids, bio-carrier and flocculant.

RESULTS AND DISCUSSION

Flow measurement and tracer study

Figure 2(a) shows the average flow rates with confidence interval of 95% at respective monitoring times. It can be seen from the figure that the flow varied widely in the range 690 to 7,000 L/h. There were two prominent peaks observed. The peak flow in the morning (10 am) is nearly twice the average flow whereas the second peak (at 2 pm) was 60% more than the average flow. The flows were below the average in the early morning and late evening hours. These temporal fluctuations in the flow were used to identify appropriate sampling periods. As mentioned earlier, the sampling programme was devised around peak, average and below average flows. The average flow was observed to be $3,430 \pm 250$ L/h (95% confidence interval) with a sample size of 175. The flows associated with the identified sampling periods were $5,740 \pm 339$ L/h (around peak 35 samples), $3,673 \pm 82$ L/h (average 35 samples) and $1,873 \pm 408$ L/h (below average 28 samples).

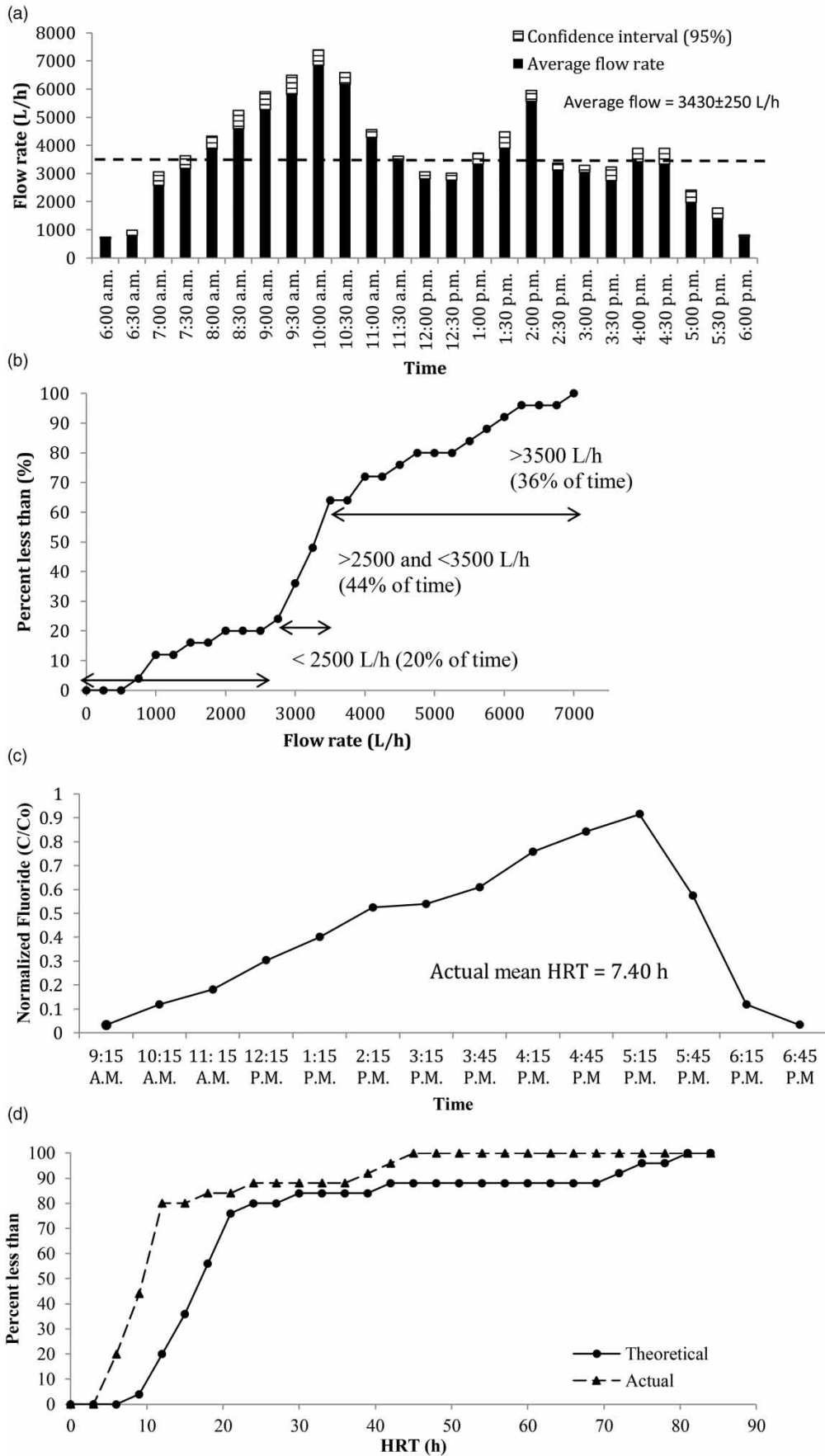

Figure 2 | (a) Results of flow measurement during 6 am to 6 pm; (b) tracer response curve (TRC) plotted to determine the actual mean HRT; (c) frequency distribution curve for theoretical and actual HRT; (d) frequency distribution plots for theoretical and actual HRT.

Figure 2(b) shows the frequency plot of flows through the ABR. The representation of flows through the frequency plot is used to quantify the extent of flows passing through the ABR. The analysis shows that the ABR was subjected to 20, 44 and 36% of the total flows that correspond to the flow rates less than 2,500 L/h, 2,500 to 3,500 L/h and more than 3,500 L/h respectively. Also, 35 and 65% of these flows were below average and above average flow rates respectively. The objective of flow data analysis (Figure 2(a) and 2(b)) is to demonstrate the dynamic flow conditions that prevailed in the ABR during its operation. These results indicate that the ABR was subjected to a wide range of flow rates to different extents and thereby dynamic hydraulic conditions were induced.

Figure 2(c) shows TRC plotted in terms of normalized fluoride concentration. This residence time distribution curve is used to determine the actual mean HRT by using Equation (1) and computed to be 7.4 h. The right skew nature of TRC was due to injection of tracer at the peak period in the morning (9.15 am) and thereafter the flows attenuated gradually (except a small second peak in the afternoon) delaying the movement of tracer towards the outlet. Also, theoretical mean HRT (Volume of ABR/Average of flow rates during tracer study period) for the tracer study period was computed and determined to be 13.67 h. It can be seen that actual mean HRT (7.4 h) is approximately twice less than that of theoretical mean HRT (13.67 h). The presence of hydraulic dead spaces affects HRT in the field-scale ABR (Singh *et al.* 2009).

The actual HRT corresponding to the flows measured are extrapolated by using experimentally obtained actual mean HRT of 7.4 h and theoretical mean HRT of 13.67 h. The computed values of actual HRT are used for further analysis. Figure 2(d) shows the frequency distribution plots for theoretical and actual HRT. The statistical analysis shows that ABR was subjected to average actual HRT of 12.66 ± 4.36 h (all extrapolated actual HRTs with 95% confidence interval). The figure also shows that HRT in the range 9 to 21 h and greater than 21 h prevailed for 65 and 25% of the time in the ABR respectively. Typical values of HRT reported for operation of the ABR are 20 to 36 h (Reynaud & Buckley 2016). However, in the present study the ABR was applied with varying HRTs with lower HRT than reported in the literature most of the time.

Influent wastewater characteristics

The influent wastewater characteristics are given in Table 1. The organic strength of influent wastewater is classified (based on COD_{Total}) to be low (<500 mg/L), medium (500 mg/L to 1,000 mg/L) and high (>1,000 mg/L). COD_{Soluble} was approximately 77, 46 and 27% of COD_{Total} for low, medium and high strength respectively. TSS contributed high strength wastewater more. The ratio of BOD_{5soluble} @ 27 °C (hereafter referred as BOD₅) to COD_{Soluble} ranged from 0.6 to 0.7, implying the amenability of the wastewater for biological treatment. pH did not vary with the strength of the wastewater and was also conducive for biodegradation. There was a slight increase in alkalinity

Table 1 | Influent wastewater characteristics

Sr. no.	Parameter	Low strength (COD _{Total} < 500 mg/L) (sample size 29)	Medium strength (COD _{Total} range between 500 mg/L to 1,000 mg/L) (sample size 30)	High strength (COD _{Total} >1,000 mg/L) (sample size 26)
1.	COD _{Total} (mg/L)	381 ± 75	732 ± 114	2,045 ± 740
2.	COD _{Soluble} (mg/L)	295 ± 90	341 ± 32	559 ± 38
3.	BOD _{5soluble} (mg/L)	184 ± 58	228 ± 30	381 ± 42
4.	BOD _{5soluble} /COD _{Soluble}	0.62 ± 0.01	0.67 ± 0.02	0.68 ± 0.03
5.	TSS (mg/L)	197 ± 35	942 ± 45	1,225 ± 150
6.	pH	7.2 ± 0.2	7.1 ± 0.2	7.2 ± 0.3
7.	EC (mS/cm)	2.4 ± 0.1	2.4 ± 0.13	2.3 ± 0.1
8.	Alkalinity (mg CaCO ₃ /L)	640 ± 70	660 ± 75	645 ± 65

with increase in strength of wastewater. EC measurements showed that the inorganic dissolved solids and nutrients (N and P) did not vary during the study period. The wastewater was an appropriate feed to ABR as it was subjected to medium or high strength wastewater most (>65%) of the time. The wide fluctuation in COD was significant as ABR was to be assessed for varying OLR conditions.

COD removal in ABR and its compartments

The ABR was monitored at different times (sampling in identified periods specified earlier) of operation. The results of monitoring are shown in Figure 3(a) (COD_{Total} (influent and effluent)), Figure 3(b) (respective flows) and Figure 3(c) (COD_{Total} removal efficiency) during the study period. The trend of variation is also shown in these figures for the respective parameters. The nature of variation

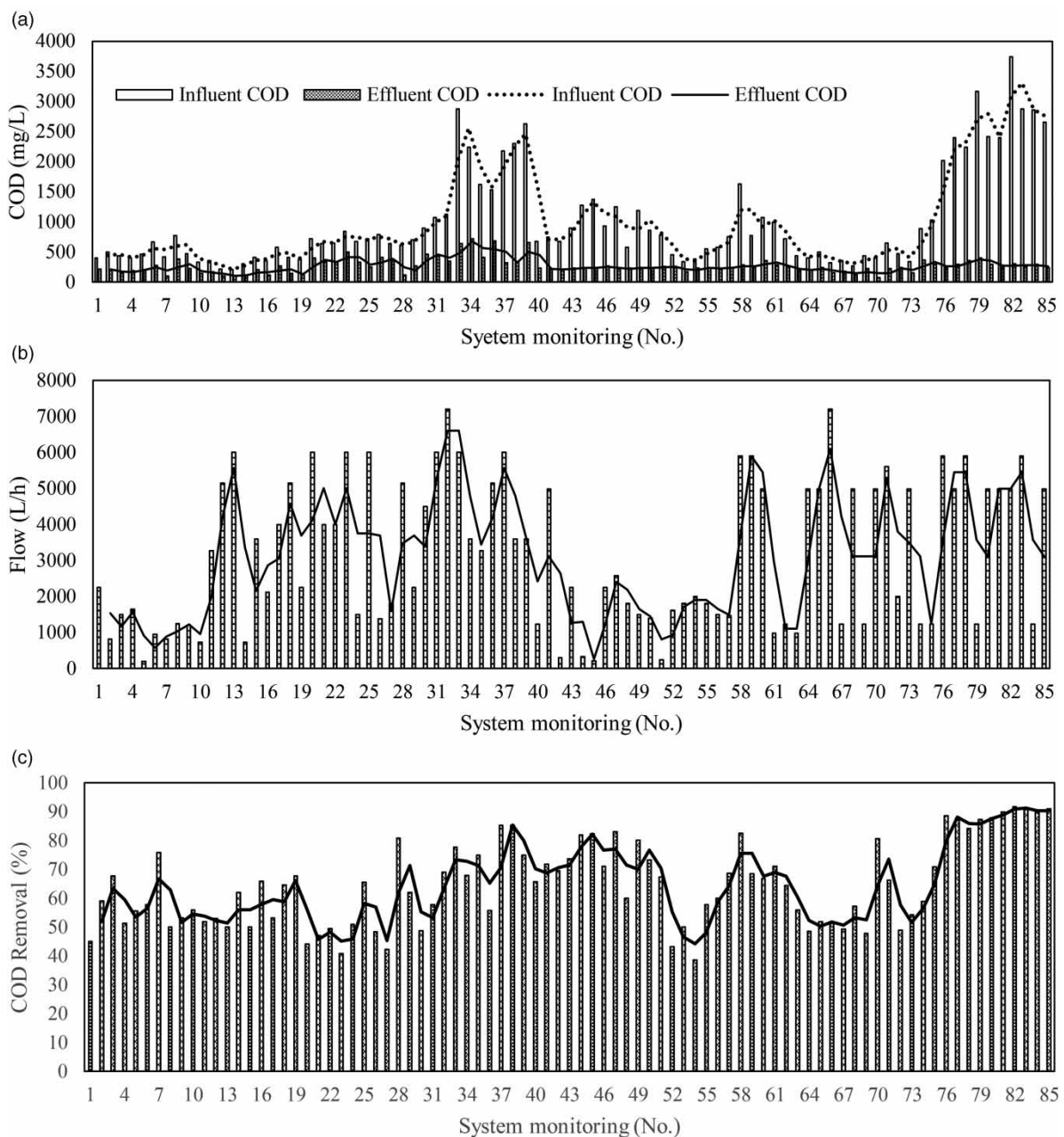

Figure 3 | (a) Operating influent and effluent COD_{Total} ; (b) operating flow conditions; and (c) COD_{Total} removal efficiency during the study period.

shown in Figure 3(a) and 3(b) indicates that ABR was operated under highly fluctuating operating conditions of influent COD_{Total} and flow. It is also significant to note that ABR was operated with different combinations (low, medium and high strength/rate) of COD_{Total} and flow. There is no definite pattern observed for these combinations acting on the system. This suggests that ABR was subjected to many minor and major shock loads in terms of strength and flow. To cite an example, major shock load and minor shock load can be noted during monitoring numbers 30 to 34, and 46 to 49 respectively. Figure 3(c) shows that the COD_{Total} removal efficiency of 45 to 90% can be obtained from ABR irrespective of such highly dynamic operating conditions. COD_{Total} removal efficiency can be correlated with earlier cited examples of minor and major shock loads. The removal efficiency of 50 to 68% (monitoring 30 to 34) and 60 to 80% (monitoring 46 to 49) were observed. The nature of variation in removal efficiency of COD_{Total} shows that the operational situations are regained repeatedly in spite of these shock loads, demonstrating the robustness of ABR for shock loads.

Further, these applied operating conditions (influent COD, flow, HLR and OLR) are analyzed to assess the performance of ABR and its compartments for COD removal. The results of COD_{Total} removal are expressed with reference to strength of wastewater and the respective applied range of HLR and OLR and are given in Table 2. The variations in COD_{Soluble}, BOD₅ of influent and effluent

Table 2 | COD removal compartment-wise for different strengths of wastewater

ABR compartment	Influent COD _{Total} (mg/L)	Effluent COD _{Total} (mg/L)	HLR (m ³ /m ² .d)	OLR (kg COD _{Total} /m ³ .d)	COD _{Total} removal (%)
Low strength (<500 mg COD _{Total} /L)					
C1	388 ± 71	318 ± 68	15.98 ± 11.08	2.38 ± 1.58	20.16 ± 10.16
C2	318 ± 68	264 ± 64	15.98 ± 11.08	1.90 ± 1.26	16.50 ± 10.90
C3	264 ± 64	236 ± 63	15.98 ± 11.08	1.69 ± 1.39	12.37 ± 4.88
C4	236 ± 63	206 ± 53	15.98 ± 11.08	1.42 ± 1.14	12.06 ± 6.70
C5	206 ± 53	185 ± 50	15.98 ± 11.08	1.38 ± 1.36	10.32 ± 6.61
C6	185 ± 50	171 ± 49	35.86 ± 24.87	2.19 ± 2.18	8.84 ± 2.25
ABR (overall)	388 ± 71 (COD _{Total}) 295 ± 90 (COD _{Soluble}) 184 ± 58 (BOD ₅)	171 ± 49 (COD _{Total}) 140 ± 52 (COD _{Soluble}) 100 ± 35 (BOD ₅)	2.97 ± 2.10	0.45 ± 0.32	55.65 ± 8.76
Medium strength (500 to 1,000 mg COD _{Total} /L)					
C1	732 ± 114	510 ± 162	15.93 ± 10.94	4.81 ± 3.39	36.05 ± 17.60
C2	510 ± 162	427 ± 144	15.93 ± 10.94	3.68 ± 3.20	24.25 ± 13.31
C3	427 ± 144	356 ± 118	15.93 ± 10.94	2.75 ± 2.20	17.01 ± 14.05
C4	356 ± 118	333 ± 108	15.93 ± 10.94	2.16 ± 1.50	11.83 ± 9.03
C5	333 ± 108	312 ± 99	15.93 ± 10.94	2.21 ± 1.73	10.66 ± 5.75
C6	312 ± 99	288 ± 82	35.75 ± 24.55	3.41 ± 2.72	10.28 ± 5.65
ABR (overall)	732 ± 114 (COD _{Total}) 341 ± 32 (COD _{Soluble}) 228 ± 30 (BOD ₅)	288 ± 82 (COD _{Total}) 154 ± 17 (COD _{Soluble}) 110 ± 12 (BOD ₅)	2.96 ± 2.03	0.87 ± 0.84	60.27 ± 10.56
High strength (>1,000 mg COD _{Total} /L)					
C1	2,045 ± 740	679 ± 178	23.56 ± 11.52	20.61 ± 12.42	61.82 ± 17.50
C2	679 ± 178	504 ± 151	23.56 ± 11.52	6.20 ± 3.96	26.31 ± 11.32
C3	504 ± 151	437 ± 130	23.56 ± 11.52	4.26 ± 2.75	13.00 ± 5.50
C4	437 ± 130	388 ± 113	23.56 ± 11.52	3.90 ± 2.43	12.88 ± 7.39
C5	388 ± 113	334 ± 94	23.56 ± 11.52	3.80 ± 2.24	12.39 ± 2.70
C6	334 ± 94	359 ± 147	52.86 ± 25.84	5.50 ± 3.22	9.41 ± 4.24
ABR (overall)	2,045 ± 740 (COD _{Total}) 559 ± 38 (COD _{Soluble}) 381 ± 42 (BOD ₅)	359 ± 147 (COD _{Total}) 225 ± 12 (COD _{Soluble}) 141 ± 14 (BOD ₅)	4.37 ± 2.18	3.42 ± 2.38	80.13 ± 10.31

of ABR are also given in the table. The result analysis pertaining to the compartments provides an insight into the variation of HLR and OLR within the ABR and contribution by each compartment for COD removal in treating different strengths of wastewater. The compartments and the ABR as a system are subjected to nearly the same HLR (approximately $16 \text{ m}^3/\text{m}^2.\text{d}$ (compartment) and $3 \text{ m}^3/\text{m}^2.\text{d}$ (ABR)) for low and medium strength wastewater. HLR values for high strength wastewater are 50% more than these respective values. The association of high strength wastewater with increase in HLR is due to peak flow rates resulting from washings of food courts and thereby contributing to more TSS and $\text{COD}_{\text{Total}}$. OLR for each compartment and the ABR is governed by influent $\text{COD}_{\text{Total}}$ for low and medium strength wastewater, whereas flow rate governs OLR for high strength wastewater. However, the overall OLR increases with strength of wastewater and is primarily governed by $\text{COD}_{\text{Total}}$ rather than flow.

$\text{COD}_{\text{Total}}$ removal is contributed significantly by the first compartment followed by the second compartment for all the strengths of wastewater. Further, this contribution for $\text{COD}_{\text{Total}}$ removal increases with increase in strength of wastewater. The percent removal decreases from C_1 to C_6 . There is no significant change in the contribution to $\text{COD}_{\text{Total}}$ removal by compartments C_3 to C_6 irrespective of the operating conditions. The rear compartments (after the third) do not contribute much in terms of $\text{COD}_{\text{Total}}$ reduction (Krishna & Kumar 2008; Peng *et al.* 2013). The highest microbial activity occurs in the first compartment of ABR under tropical conditions (Feng *et al.* 2008; Reynaud & Buckley 2016).

The increasing trend can also be observed in overall $\text{COD}_{\text{Total}}$ removal from low to high strength wastewater. It is possible to remove $\text{COD}_{\text{Total}}$ to an extent (average) of 56, 60 and 80% for low, medium and high strength wastewater respectively by ABR. The increase in TSS with increase in strength appears to be the reason for more $\text{COD}_{\text{Total}}$ removal in high strength wastewater. TSS are also removed significantly (68% (low strength); 90% (medium strength); 96% (high strength)) thereby contributing to the $\text{COD}_{\text{Total}}$ removal. The respective removal efficiencies for (i) $\text{COD}_{\text{Soluble}}$ are 53, 55, and 60%; and (ii) BOD_5 are 45, 52 and 63%.

Effect of OLR and HLR on $\text{COD}_{\text{Total}}$ removal

HLR and OLR are important design parameters that affect the performance of the ABR. Hence, the effect of variation in HLR and OLR, and their combinations needs to be assessed for the removal of $\text{COD}_{\text{Total}}$. Figure 4 shows the applied HLR and OLR along with the trend line of their variations throughout the study period. It can be seen that there were no shorter/longer durations for which the ABR was operated with both HLR and OLR were constant. The fluctuations in HLR are more pronounced than that of OLR. ABR was subjected to 0.26 and $7.72 \text{ m}^3/\text{m}^2.\text{d}$ (lowest and highest HLR), and 0.03 and $8 \text{ kg COD}/\text{m}^3.\text{d}$ (lowest and highest OLR). This is an indicative of dynamic operational conditions prevailed in ABR.

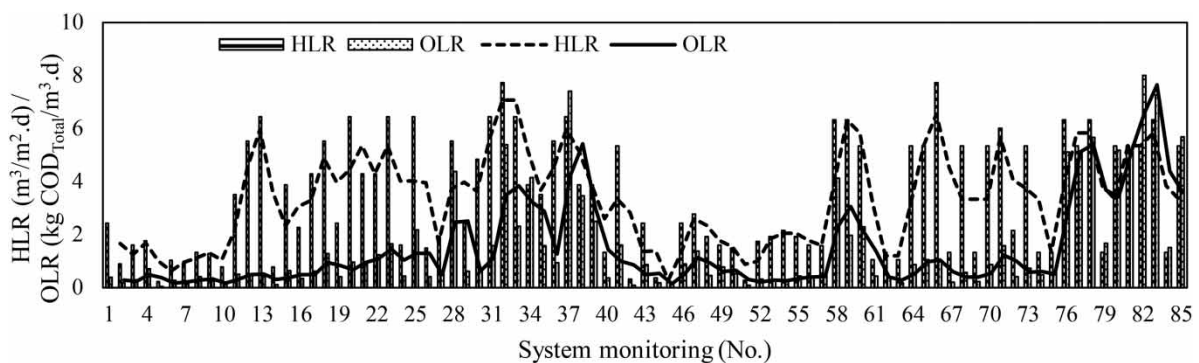

Figure 4 | Variation in HLR and OLR.

These variations in HLR and OLR are related to the respective COD_{Total} removal efficiencies shown in Figure 3(c). In order to quantify and analyze this relation, HLR and OLR are categorized into low, medium, high and very high based on their values. The defined categories are low (<2 m³/m².d (HLR) kg COD_{Total}/m³.d (OLR)), medium (2 to 4 m³/m².d (HLR) kg COD_{Total}/m³.d (OLR)), high (4 to 6 m³/m².d (HLR) kg COD_{Total}/m³.d (OLR)), and very high (> 6 m³/m².d (HLR) kg COD_{Total}/m³.d (OLR)). The summary of results analysis based on Figures 3(c) and 4 is given in Table 3. It can be seen that the ABR was operated with extreme (Low HLR-Low OLR; Very high HLR – Very high OLR) combinations of HLR and OLR. COD_{Total} removal efficiency was lower for low (HLR and OLR) when compared to high (HLR and OLR). More than 70% of COD_{Total} was removed when the ABR was subjected to medium and above categories of HLR and OLR. The consistency in COD_{Total} removal demonstrates the sturdiness of the ABR irrespective of variations in OLR and HLR. These results are in accordance with the basic hypothesis that anaerobic systems perform better for high strength wastewater.

Table 3 | COD_{Total} removal by ABR for fluctuating HLR and OLR

Range					
HLR (m ³ /m ² .d)	OLR (kg COD/m ³ .d)	HRT (h)	HLR (m ³ /m ² .d)	OLR (kg COD/m ³ .d)	COD _{Total} removal (%)
<2 (L)	<2 (L)	> 30	1.23 ± 0.51	0.39 ± 0.34	62.40 ± 12.44
2 to 4 (M)	<2 (L)	30 to 15	2.69 ± 0.59	0.68 ± 0.42	61.74 ± 12.66
4 to 6 (H)	<2 (L)	15 to 10	5.16 ± 0.53	0.95 ± 0.35	57.10 ± 10.08
> 6 (VH)	<2 (L)	10 to 7.5	6.63 ± 0.53	1.27 ± 0.54	52.19 ± 9.89
2 to 4 (M)	2 to 4 (M)	30 to 15	3.86 ± 0.01	3.36 ± 0.83	75.76 ± 8.95
4 to 6 (H)	4 to 6 (H)	15 to 10	5.38 ± 0.07	5.09 ± 0.47	87.45 ± 3.87
> 6 (VH)	2 to 4 (M)	10 to 7.5	6.43 ± 0.01	2.34 ± 0.09	71.88 ± 8.44
> 6 (VH)	4 to 6 (H)	10 to 7.5	6.32 ± 0.01	4.96 ± 0.78	85.10 ± 3.13
> 6 (VH)	> 6 (VH)	10 to 7.5	6.38 ± 0.08	7.33 ± 0.09	88.43 ± 3.45

L, Low; M, Medium; H, High; VH, Very high.

A low HLR and high OLR combination was not observed during the study. These results also demonstrate that increase in OLR has more effect than HLR on COD_{Total} removal. It can be clearly seen that an applied peak HLR of 7.72 m³/m²/d with upflow velocity of 0.32 m/h did not hamper the performance of the ABR, indicating its stability to absorb hydraulic shock loading. Also when the HLR was observed to be low, not much removal efficiency was achieved as OLR values were at their lowest peak associated with low strength influent. Thus, OLR dominated the performance of the ABR more than HLR.

Table 4 shows the literature (Barber & Stuckey 1999) reported COD_{Total} removal efficiencies for different OLRs and their comparison with the current study. COD_{Total} removal reported is 85 to 95% for OLR 1 to 6 kg COD_{Total}/m³.d and it increases with OLR. However, the lower removal efficiencies (60 to 90%) are observed in the current study for OLR of 1 to 8 kg COD_{Total}/m³.d as compared to the other studies. This is due to the fact that the other studies reported were conducted under controlled operational conditions in laboratories whereas the current study was conducted on the field-scale ABR subjected to fluctuations in OLR and HLR.

Variation of pH, alkalinity and VFA in ABR compartments

There was no significant change or sudden drop in pH observed throughout the study period. However, a slight increase in pH was noted from the first to the last compartment. Alkaline conditions prevailed in all ABR compartments as the pH value was above 7 indicating existence of suitable

Table 4 | Comparison of percent COD_{Total} removal efficiencies for varied OLR reported by other studies with current study (Source: Barber & Stuckey 1999; interpretation of graph in tabular form)

OLR (kg COD _{Total} /m ³ .d)	COD _{Total} removal (%) reported by	
	Other study	Current study
1	85 (Witthauer & Stuckey 1982)	60
2	85 (Yang & Moengangongo 1987)	65
2.5	90 (Garuti <i>et al.</i> 1992)	70
4.9	99 (Nachaiyasit & Stuckey 1995)	88
5	89 (Bachmann <i>et al.</i> 1985)	90
6	98 (Yang <i>et al.</i> 1988)	90
8	–	90

conditions for anaerobic action. Methanogens are sensitive to the changes in pH, and the optimal pH range of methanogen activity is 6.8 to 7.2. Also such stable pH values indicate good buffering capacity of wastewater. The variation in alkalinity and volatile fatty acids (VFA) in the ABR compartments is shown in Figure 5. Alkalinity increases from initial to latter compartments and vice-versa for VFA. The compartmentalized nature of ABR can be clearly observed.

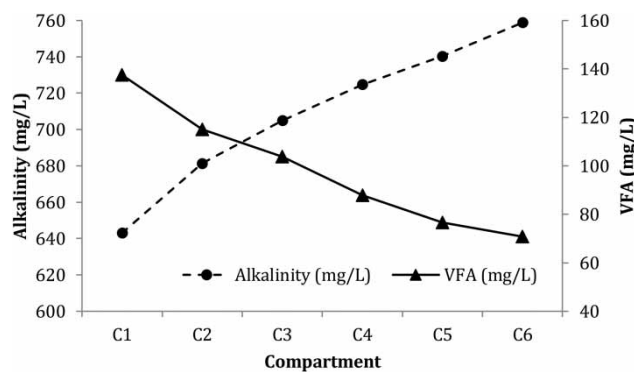
**Figure 5** | Variation of alkalinity and VFA in different ABR compartments.

The presence of more VFA and less alkalinity is suggestive of an acidogenic phase in the initial compartments and vice versa is indicative of methanogenic phase in the latter compartments. A predominance of hydrolyzing and acid-producing micro-organisms was observed using SEM in the first compartment and a large quantity of *Methanosaeta* in the second and third compartments, which gradually decreased towards the end compartments (Krishna *et al.* 2009). Spatial distribution of microbial communities in the ABR compartments treating soluble wastewater was investigated by (Peng *et al.* 2013). These studies justify the observed results of phase separation throughout the ABR compartments. Generally, the desired alkalinity for maintaining a stable anaerobic environment ranges from 2,000 to 4,000 mg CaCO₃/L for enhanced removal of COD. In the present study, alkalinity is observed to be in the range of 650 to 850 mg CaCO₃/L. The observed VFA values were acceptable as the desired VFA concentration to maintain utmost anaerobic stability ranges from 50 to 300 mg CaCO₃/L. VFA/Alkalinity ratio of 0.3 to 0.4 are typical indicators of stable anaerobic digestion with maximum biogas yield for a particular temperature. The observations showed that the highest ratio of VFA/Alkalinity (~0.25) prevailed in the first ABR compartment and decreased to 0.10 in the last compartment. However, the conditions were conducive for anaerobic process in ABR which was demonstrated through COD_{Total} removal.

Sludge characterization

The sludge characterization was carried out in terms of pH, total solids (TS), volatile solids (VS), fixed solids (FS), and moisture content (MC). The results of sludge characterization for each compartment are given in Table 5. There was no significant variation in pH. COD_{Total} varied significantly in the range of 21,000 to 32,000 mg/L across the compartments. Figure 6 shows the variation of TS, VS and FS content in compartments of the ABR. TS and VS concentration was observed to be more in the first two compartments, and further decreased gradually in the following compartments. VS content was 70 to 80% of the TS content, which indicates higher biodegradable organic content in the sludge.

Table 5 | Characteristics of sludge from different ABR compartments

ABR compartments	COD_{Total} (mg/L)	Total solids (mg/L)	Fixed solids (mg/L)	Volatile solids (mg/L)	Volatile solids (%)	Moisture content (%)
C1	21,410 ± 550	1,13,526 ± 120	21,432 ± 175	89,594 ± 200	78.16 ± 4.6	91.04 ± 1.2
C2	26,086 ± 400	1,11,072 ± 200	29,837 ± 130	81,234 ± 180	73.16 ± 5.8	91.41 ± 1.7
C3	31,332 ± 520	85,424 ± 320	28,258 ± 122	57,165 ± 185	66.98 ± 3.3	91.83 ± 1
C4	29,840 ± 580	82,063 ± 180	25,453 ± 200	56,610 ± 220	68.92 ± 4.3	90.65 ± 2.3
C5	29,861 ± 510	81,812 ± 230	28,967 ± 185	52,845 ± 160	64.45 ± 7.7	92.75 ± 1.3
C6	29,162 ± 450	80,560 ± 105	24,984 ± 132	50,437 ± 180	62.57 ± 6.8	92.03 ± 2.4

Sample size 15 in each compartment.

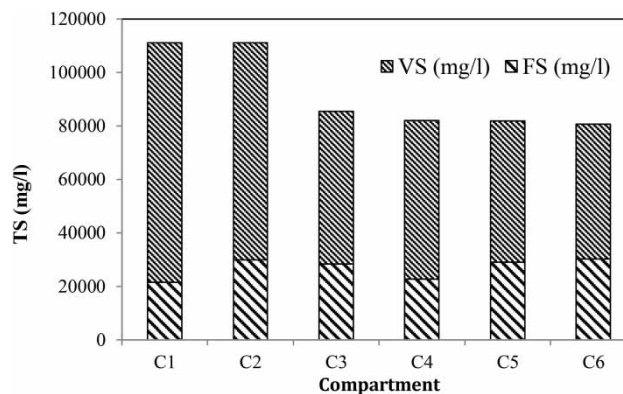

Figure 6 | Variation in TS, VS and FS content in sludge through different ABR compartments.

Figure 7(a) and 7(b) show typical photographs of the sludge depth measurement rod. The sludge solids attached to the rod in the first and last compartment are visible in this photographic view. The depth of sludge was measured with reference to the dark portion on the white background of Velcro tape. Figure 7(c) shows the depth of sludge in all ABR compartments at the end of the study period. The initial depth of sludge in all compartments was 5 cm. The depth varied linearly with more accumulation of sludge solids in the initial compartments and less in the rear compartments during the operation of the ABR. The rate of sludge accumulation varied linearly from 0.12 to 0.02 m/month for the first to last compartments. The sludge depth is also correlated to COD_{Total} removal. The higher depth provides more chance of contact between substrate and biosolids in the sludge blanket. This correlation is evident in higher COD_{Total} removal in the initial compartments.

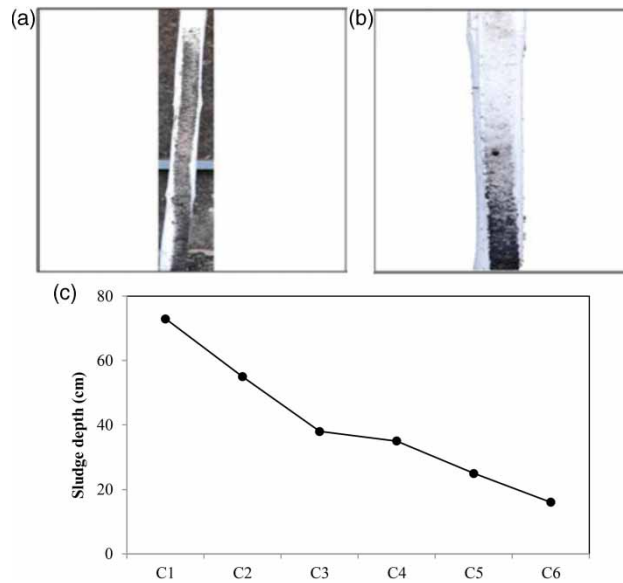

Figure 7 | Photographic view of measurement rod coated with sludge solids in (a) first ABR compartment and (b) sixth ABR compartment; (c) sludge depth and its variation in all compartments.

Sludge granulation study through scanning electron microscopy (SEM)

SEM analysis of the sludge was carried out to discover the structure of the sludge and granulation stage in the initial (first three compartments) and the rear (last three compartments) portions of the ABR. Figure 8(a) and 8(b) show SEM photographs of sludge from the initial portion of the ABR. It shows that the nature of the sludge is a dense floc type (Figure 8(a)) and initiation in granulation of sludge solids (Figure 8(b)). The size of sludge granules is less than 1 mm. Sludge granules with cavities and irregular surfaces can be observed in the initial portion (Figure 8(b)). However, the quantity of sludge granules formed is much less considering the amount of sludge in the initial compartments. SEM results of the rear portion are shown in Figure 8(c) and 8(d) and it can be seen that the type of sludge is floccular in nature and there is no indication of sludge granulation. The sludge flocs in the compartments appear to be attached with precipitated crystals inside as shown in Figure 8(d).

Development of sludge granules after application of sludge granulation technique

Sludge granulation was applied in the last compartment of the ABR by using sand and PAC. This study was conducted to assess the effectiveness of the granulation technique with sand and PAC. The last compartment was chosen as no sludge granules were observed naturally in this compartment during the initial performance study. It was also expected to minimize washout of sludge solids from the last compartment due to higher upflow velocity. Figure 9(a) and 9(b) show SEM photographs of the sludge in the last ABR compartment and actual visible sludge granules respectively. The results show that there are no sand particles visible separately. The observations indicate that sand forms nuclei and PAC (as a binding agent) enhances the adherence of sludge solids thereby aiding the sludge granulation process. The sludge characteristics after application of the sludge granulation technique showed improved biomass retention as the VS content increased to 86%. The sludge depth in the last compartment after granulation showed 20% reduction, indicating a compacted sludge layer reflecting the effect of sludge granulation by sand and PAC.

Particle size analysis of sludge solids was made in all ABR compartments at the end of the study. Maximum average size of sludge solids was observed to be 862 μm in the first compartment. The size of sludge solids decreased gradually up to the fifth compartment. The maximum size of sludge

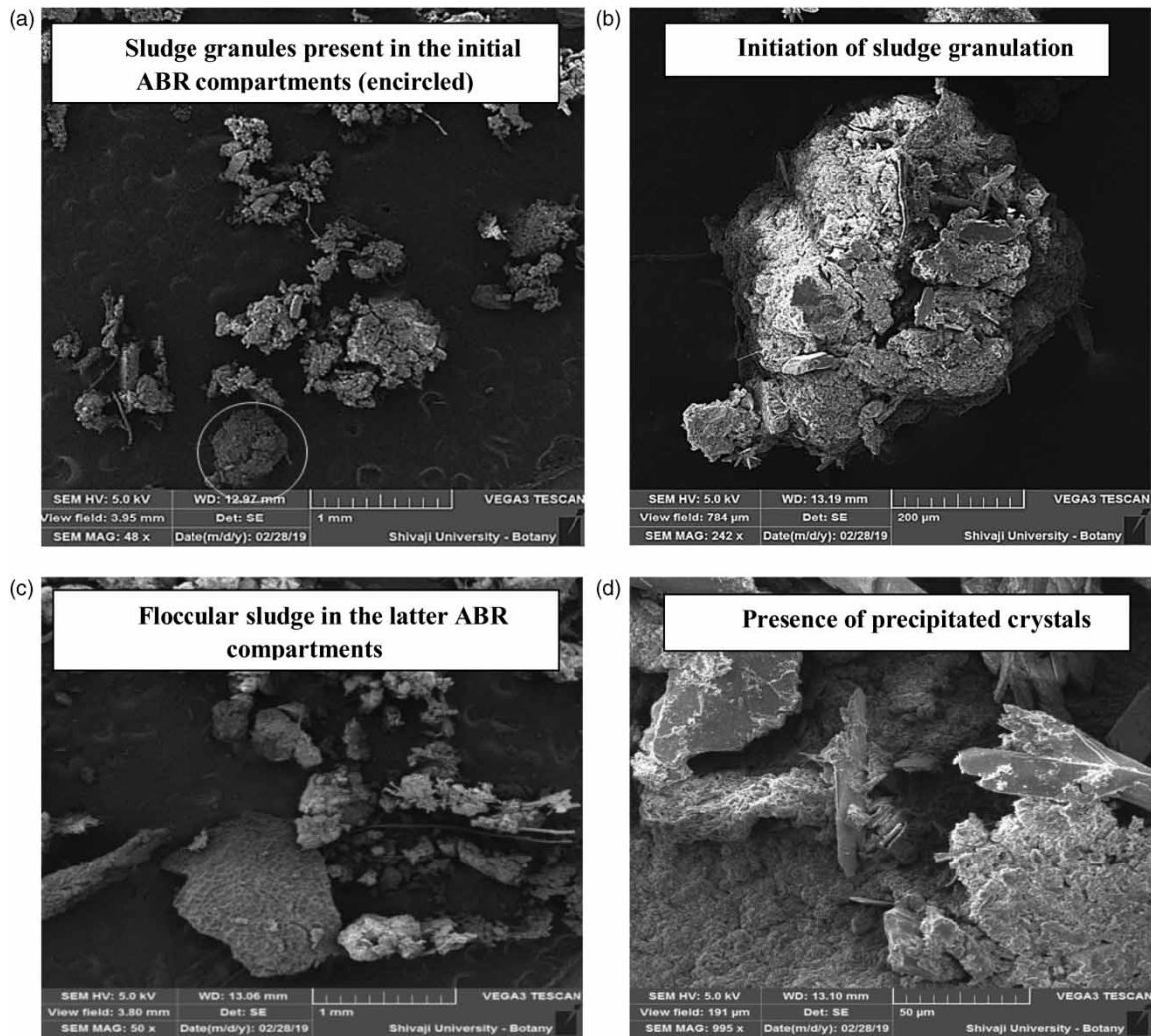

Figure 8 | Scanning electron micrographs showing (a) presence of sludge granules in the initial ABR compartments; (b) initiation of sludge granulation with cavities on the granule surface; (c) floccular sludge present in the latter compartments; (d) presence of precipitated crystal in sludge biomass.

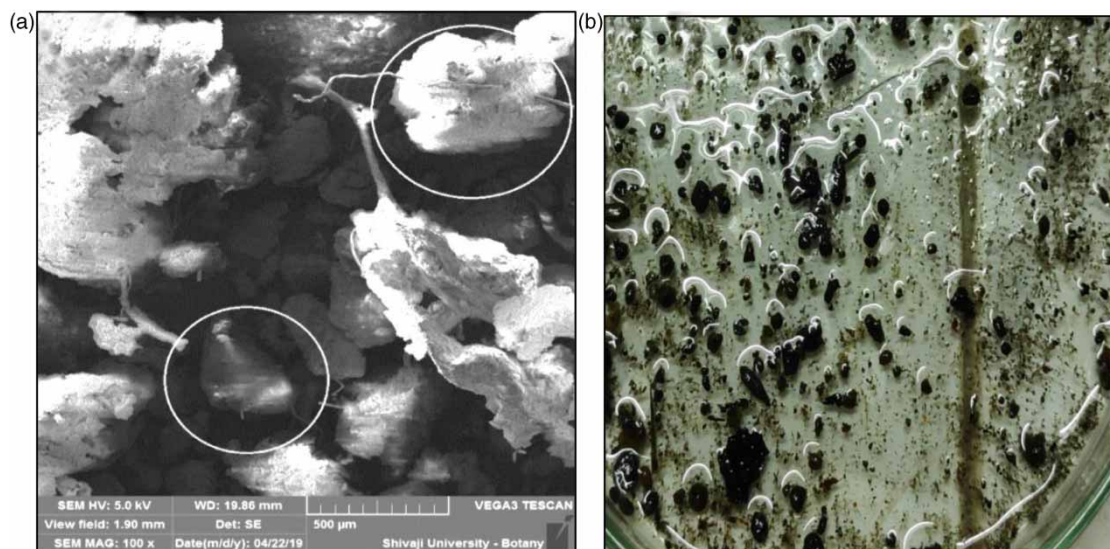

Figure 9 | Scanning electron micrograph showing (a) formation of sludge granules in the sixth compartment after addition of sand and PAC; (b) visible granules.

solid was observed to be 629 μm and 1,471 μm before and after sludge granulation in the last compartment respectively. However, there was no significant improvement (average 7 to 10%) in $\text{COD}_{\text{Total}}$ removal efficiency as sludge granulation was applied in only one compartment. The study demonstrated that sludge granulation can be effective in developing a compact mass of sludge and enhancement of biomass retention under dynamic conditions.

CONCLUSION

Extensive field-scale experimentation was carried out on an ABR under dynamic conditions induced by OLR and HLR. The characteristics of wastewater within the ABR compartments were also studied. The effect of sludge granulation with and without sand aided by PAC was assessed. The ABR has a potential to treat low (less than 500 mg $\text{COD}_{\text{Total}}/\text{L}$), medium and high (greater than 1,000 mg $\text{COD}_{\text{Total}}/\text{L}$) strength wastewater. The removal efficiency for carbonaceous organic matter and TSS increases with strength of wastewater. The initial compartments of the ABR contribute more to the removal. The performance of the ABR was governed by OLR rather than HLR. The ABR showed phase separation throughout the compartments even under dynamic conditions. TS, VS and sludge depth were greater in the initial two compartments and decreased gradually in the rear compartments. Sludge granulation occurred in the initial three compartments and the nature of the sludge was floccular. Sludge granulation with sand and PAC was effective as it enhanced sludge granule size, contributed to $\text{COD}_{\text{Total}}$ removal and formed a more compact sludge layer under dynamic conditions. In the operation of the ABR it is possible to achieve $\text{COD}_{\text{Total}}$ removal of 60 to 90% under dynamic conditions.

ACKNOWLEDGEMENT

The present study is a part of a research project sanctioned by Department of Science and Technology (DST) under Water Treatment Initiative (WTI) programme. The authors sincerely acknowledge and thank DST for providing financial support to undertake this study.

DATA AVAILABILITY STATEMENT

All relevant data are included in the paper or its Supplementary Information.

REFERENCES

- APHA/AWWA/WEF 2012 *Standard Methods for the Examination of Water and Wastewater*, 22nd edn. American Public Health Association/American Water Works Association/Water Environment Federation, Washington, DC, USA.
- Bachmann, A., Beard, V. L. & McCarty, P. L. 1985 *Performance characteristics of the anaerobic baffled reactor*. *Water Research* **19**(1), 99–106.
- Barber, W. P. & Stuckey, D. C. 1999 *The use of the anaerobic baffled reactor (ABR) for wastewater treatment: a review*. *Water Research* **33**(7), 1559–1578.
- Bernd, G., Ludwig, S., Thilo, P. & Thorsten, R. 2009 *Decentralised Wastewater Treatment Systems (DEWATS) and Sanitation in Developing Countries – A Practical Guide*. Water, Engineering and Development Centre (WEDC), Loughborough University, Loughborough, UK, in association with BORDA, Germany, p. 168.
- Feng, H. J., Hu, L. F., Shan, D., He, Y. H. & Shen, D. S. 2008 *Effects of operational factors on soluble microbial products in a carrier anaerobic baffled reactor treating dilute wastewater*. *Journal of Environmental Science* **20**(6), 690–695.
- Garuti, G., Dohanyos, M. & Tilche, A. 1992 *Anaerobic-aerobic combined process for the treatment of sewage with nutrient removal – the ANANOX(R) process*. *Water Science and Technology* **25**(7), 383–394.

- Hu, X., Li, Z. & Cai, H. 2006 Influence of shock loads on anaerobic baffled reactor treating low strength wastewater. *Environmental Science and Technology* **29**(3), 76–78.
- Krishna, G. G. V. T. & Kumar, P. 2008 Treatment of low strength complex wastewater using an anaerobic baffled reactor (ABR). *Bioresource Technology* **99**, 8193–8200.
- Krishna, G. G. V. T., Kumar, P. & Kumar, P. 2009 Treatment of low-strength soluble wastewater using an anaerobic baffled reactor (ABR). *Journal of Environmental Management* **90**, 166–176.
- Liu, S., Bao, J., Hu, X. & Xin, X. 2007 Influence of shock load on performance of anaerobic baffled reactor. *Safety and Environmental Engineering* **14**(1), 76–79.
- Nachaiyasit, S. & Stuckey, D. C. 1995 Microbial response to environmental changes in an anaerobic baffled reactor (ABR). *Antonie van Leeuwenhoek* **67**, 111–123.
- Peng, J. F., Song, Y. H., Wang, Y. L., Yuan, P. & Liu, R. 2013 Spatial succession and metabolic properties of functional microbial communities in an anaerobic baffled reactor. *International Biodeterioration and Biodegradation* **80**, 60–65.
- Pillay, S., Reynaud, N., Schoebitz, L., Pietruschka, B. & Buckley, C. A. 2009 Evaluation of the DEWATS Process for Decentralised Wastewater Treatment, Volume 2: DEWATS Performance. WRC K5/2002.
- Reynaud, N. & Buckley, C. A. 2015 Field-data on parameters relevant for design, operation and monitoring of communal decentralized wastewater treatment system (DEWATS). *Water Practice and Technology* **10**(4), 787–798.
- Reynaud, N. & Buckley, C. A. 2016 The anaerobic baffled reactor (ABR) treating communal wastewater under mesophilic conditions: a review. *Water Science and Technology* **73**(3), 463–478.
- Sathe, S. M. & Munavalli, G. R. 2019 Domestic wastewater treatment by modified bio-rack wetland system. *Journal of Water Process Engineering* **28**, 240–249.
- Schalk, T., Marx, C., Ahert, M., Krebs, P. & Kühn, V. 2019 Operational experience with a full-scale anaerobic baffled reactor treating municipal wastewater. *Water Environment and Research* **91**, 54–68.
- Singh, S., Haberl, R., Shrestha, R. R., Shresthad, P. & Shrestha, R. 2009 Performance of an anaerobic baffled reactor and hybrid constructed wetland treating high-strength wastewater in Nepal—a model for DEWATS. *Ecological Engineering* **35**(5), 654–660.
- Uyanik, S., Sallis, P. J. & Anderson, G. K. 2002a The effect of polymer addition on granulation in an anaerobic baffled reactor (ABR) part I: process performance. *Water Research* **36**, 933–943.
- Uyanik, S., Sallis, P. J. & Anderson, G. K. 2002b The effect of polymer addition on granulation in an anaerobic baffled reactor (ABR) part II: compartmentalization of bacterial populations. *Water Research* **36**, 944–955.
- Wenjie, Z., Dunqiu, W., Yasunori, K., Taichi, Y., Li, Z. & Kenji, F. 2008 PVA-gel beads enhance granule formation in a UASB reactor. *Bioresource Technology* **99**, 8400–8405.
- Witthauer, D. & Stuckey, D. 1982 Laboratory Studies on Anaerobic Processes to Treat Dilute Organic Wastewater in Developing Countries. IRCWD, EAWAG, Dubendorf, Switzerland.
- Yang, P. Y. & Moengangongo, T. H. 1987 Operational stability of a horizontally baffled anaerobic reactor for diluted Seine wastewater in the tropics. *Transactions of the ASAE* **30**(4), 1105–1110.
- Yang, X., Garuti, G., Farina, R., Parisi, V. & Tilche, A. 1988 Process differences between a sludge bed filter and an anaerobic baffled reactor treating soluble wastes. In: *5th International Symposium on Anaerobic Digestion*, Bologna, Italy, pp. 355–360.
- Zhu, G., Zou, R., Jha, A. K., Huang, X., Liu, L. & Liu, C. 2015 Recent developments and future perspectives of anaerobic baffled bioreactor for wastewater treatment and energy recovery. *Critical Reviews in Environmental Science and Technology* **45**, 1243–1276.