

Intelligent pressure management by pumps as turbines in water distribution systems: results of experimentation

S. Parra, S. Krause, F. Krönlein, F. W. Günthert and T. Klunke

ABSTRACT

Pressure reducing valves (PRVs) are used in water distribution networks (WDNs) for pressure control and water loss reduction. In this study, a system composed of a PRV and a pump as turbine (PAT) in combination with intelligent pressure management is proposed and its performance is analysed experimentally. For this, data analysis using hydraulic modelling and extensive experimentation for a case study in Germany was performed. During the laboratory tests, the pressure at the critical point of the system could be successfully maintained at the selected value at variable discharges during a characteristic day, as a result of the advanced pressure modulation. Additionally, up to 2.3 kW of electrical energy were recovered, when the applied PAT was operating under full load, with a maximum total net system efficiency of 40%. Furthermore, the proposed pressure management was found to increase the water savings by up to 16% compared to conventional PRVs. This study concludes that the PAT-PRV-system may be suitable in WDNs with high differences in altitude, high operational pressures and high demand variability. For its application, the benefits and the investment costs, as well as the seasonal flow and pressure variations in the WDN should be analysed in detail.

Key words | energy recovery, pressure management, pressure reducing valve, pump as turbine, water distribution system

S. Parra (corresponding author)

S. Krause

F. Krönlein

F. W. Günthert

Sanitary Engineering and Waste Management,
University of the Federal Armed Forces Munich,
Werner-Heisenberg-Weg 39,
85577 Neubiberg,
Germany
E-mail: salome.parra@unibw.de

T. Klunke

KSB Aktiengesellschaft,
Application & Basic Research,
Johann-Klein-Str. 9,
67227 Frankenthal,
Germany

INTRODUCTION

Water distribution networks (WDNs), as complex infrastructure systems, will face important challenges concerning their capacity, rehabilitation and maintenance in the decades to come. It is the responsibility of water supply companies to provide top quality water while operating efficiently and cost-effectively. A critical issue here might be that many WDNs were designed and built around 80–100 years ago, so that currently modified conditions (i.e. water demand), ageing and leaking pipelines are the consequence. With rehabilitation measures, water losses can be reduced by repairing or renewing damaged pipes. However, additional benefits can be achieved if the rehabilitation of the system is combined with optimization measures as well. In Germany, as an industrialized nation, technologies for a more effective and economical energy use are being considered nowadays. The optimization of the water distribution, in the pump

operation (Nowak *et al.* 2015), and utilising the surplus energy in tank filling or in transport pipelines by using turbines or pumps as turbines (Kramer & Wieprecht 2012; Haakh *et al.* 2013; Nowak *et al.* 2015; Sitzenfrey *et al.* 2015) are a few examples. Despite these new technologies, reducing the water losses, which in Germany account on average for 7.6% of the water feeding volume (Statista 2016) and comprise $0.07 \text{ m}^3/(\text{km} \cdot \text{h})$ real water losses (BDEW 2015), and the rehabilitation of water networks are still the most important challenges.

The relationship between lower pressure and lower leakage rates has been discussed intensively for more than two decades. Nowadays it is also well understood that lower pressure in the water network results in fewer pipe breaks (Fantozzi *et al.* 2009), is more energy efficient and minimizes pipe replacement costs (Jernigan 2016). As Lambert

proposed, an effective water loss strategy consists of three fundamental factors: pressure in the network is managed, repair and rehabilitation measures are in place, and there is an active leakage control (Lambert 2001). It should be emphasized that pressure and water loss strategies do not negate the need for rehabilitation and repair of the grid.

Pressure reducing valves (PRVs) are commonly used for controlling the pressure in the network, preventing water stress in pipelines and armatures and avoiding new bursts in the grid. Conventional fixed outlet PRVs reduce the inlet pressure (p_{in}) to a defined value (p_{out}) and deliver a constant operational pressure, irrespective of the water demand. For enhanced pressure management, more advanced technologies, so-called time-modulated (a), flow-modulated (b) or remote-controlled (c) pressure control devices can be installed. Advanced pressure management devices reduce the pressure depending on daytime and off-peak periods (a), water consumption (b) and actual pressure at one or multiple critical points within the supply area (c) (GIZ & VAG 2011; Hamilton & McKenzie 2014). The decision whether to apply conventional PRVs or an advanced pressure management device depends strongly on the conditions within the supply area, such as the amount of water loss, the variability of the water demand during the day, investment costs and available personnel.

The use of conventional PRVs in water systems results in energy that is 'lost' through its conversion into noise and heat. This energy dissipation can be reduced if turbines take over the function of conventional PRVs with the aim of recovering the pressure energy in the distribution network by transforming it into electricity. Further economical savings can be achieved by using pumps as turbines (PATs) instead of more expensive turbine aggregates (Giugni *et al.* 2009, 2013; Ramos *et al.* 2010; Carravetta *et al.* 2013; Samora *et al.* 2016). The research project EWID (the abbreviation in German for energy recovery in the water distribution system by intelligent pressure management) proposes a dynamic PAT-PRV-system that includes an advanced pressure management strategy for variable hydraulic situations. For this purpose, the consortium of EWID is developing an innovative system, composed of a pressure control unit (PRV) and an energy production unit (PAT + generator) located in the bypass of the main pipeline, as well as a control unit for intelligent pressure management.

The control system of the PAT-unit integrates the real time hydraulic data of the distribution network. The data are provided by measuring devices installed at one or more critical points in the supply area (e.g. the highest or deepest points in the network), as well as other model-based parameters (see Figure 1). The goal is to develop demand-based pressure management whilst maximizing energy production, hence enabling EWID to improve energy efficiency in the water sector. In addition, the intelligent pressure control contributes significantly to the reduction of material stress and real water losses in the WDN, thereby promoting the sustainable use of natural water resources.

In this paper, the results of the experimental and development phases of the EWID system for a WDN (case study) at the water utility Wasserversorgungszweckverband Perlenbach (PER) in western Germany are presented. These phases comprise detailed data acquisition and analysis for dimensioning the PAT-unit. Hydraulic modelling plays a decisive role, not only for identifying the critical nodes in the WDN, but also for understanding and predicting the hydraulics in the network, and for implementing accurate advanced pressure management driven by the PAT. Furthermore, the actual energy yield of the system was monitored at a testing stand developed exclusively for this purpose at the University of the Federal Armed Forces Munich (UniBwM), prior to its installation in the field. The system proposed in this paper provides a good example of how PRVs can be combined with PATs for energy generation and water loss reduction.

METHODOLOGY

For each stage of development of the proposed PRV-PAT-system and its additional components, extensive experimentation on a testing installation was required. In order to define the testing configuration, the hydraulic conditions of the selected pilot supply area in PER (case study) were collected and simulated using hydraulic modelling. The experimental system unit is optimised and installed in a real water network (field test) once the design and validation of the experimental system unit is complete. Hereby, the system control with installed pressure sensors at critical points will be identified, in order to test the proposed advanced pressure management.

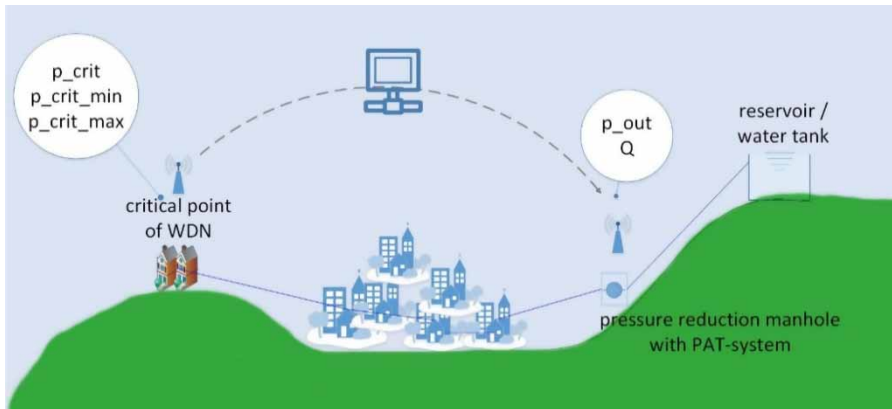

Figure 1 | Approach of research project EWID.

Data basis and hydraulic modelling

EPANET 2.0 (Rossman 2000) was used to analyse the hydraulic situation in the studied WDN. The input data required for running the dynamic model, as well as for designing the PAT for the experimentation, comprised the following:

- Water network data from the Geographic Information System, provided by the water supply company.
- The water outflow from reservoirs and tanks recorded in June 2015 during 6 days (in 5 min intervals), which was used for creating a characteristic pattern for the domestic consumption in the hydraulic model, as well as for the experimentation tests (see Figure 2). To create the characteristic pattern, the data were filtered to remove outliers due to planned flush events. Afterwards, the flow values were averaged for every hour of the day, taking into consideration work and weekend days separately. The pattern of industrial water consumption (paper factory) was considered to be extra.
- The inlet and outlet pressures at the actual PRV's manholes, where the PAT-unit will be implemented (field tests). These parameters were recorded in June 2015 during 6 days using portable pressure sensors (in 5 min intervals).
- The annual billed water consumption per village (in m^3 per year). These data were used for an estimation of the nodal demand in the model.
- The estimated amount of water losses Q_{RL} . Here, the minimum night flow Q_{MNF} was used for estimating the

water losses, as no water balance data were available. In this case, the water volume lost due to physical leakages in mains, storage tanks and service connections (defined as real water losses, Q_{RL}) was derived from the measured data, as recommended by the German Technical and Scientific Association for Gas and Water (DVGW):

$$Q_{RL} = Q_{MNF} - Q_{rest} \quad (1)$$

$$q_{RL} = \frac{Q_{RL}}{L_N} \quad (2)$$

where Q_{RL} [m^3/h] = real water losses, Q_{MNF} [m^3/h] = minimum night flow, Q_{rest} [m^3/h] = rest water consumption =

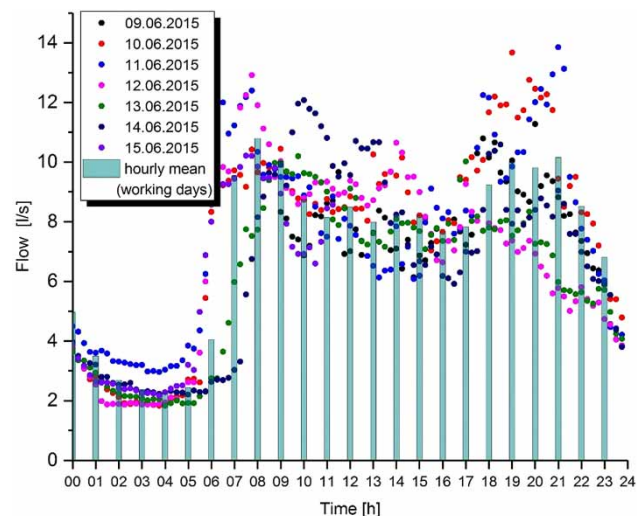

Figure 2 | Characteristic pattern of domestic demand (hourly mean, working days) used for hydraulic modelling and for the experimentation tests derived from the flow measurements in June 2015 for the case study (PER).

0.6–0.8 m³/h per 1,000 inhabitants, q_{RL} [m³/(h*km)] = specific real water losses and L_N [km] = network length without service connections (DVGW 2003). For a minimum night flow of 6.34 [m³/h] (according to the measurements on site), an assumed rest water consumption of 0.8 [m³/h], 1,200 supplied inhabitants and 27 km network length, the calculated specific real water loss q_{RL} of 0.12 m³/(h*km) correlates with the estimation provided by the water supply company and comprises 80–85% of the minimum night flow. According to German reference values (DVGW 2003), the water loss volume is high for typical rural regions.

Hydraulic modelling was carried out for evaluating the temporal and spatial changes of water pressure and flow in the studied water distribution system (network characterization), as well as for finding the critical points in the WDN. In general, depending on the topography of the supply area, the critical points are defined as:

- (a) the nodes where the operational pressure is more likely to fall below the minimal allowed value (1.5 bar in case of fire), for instance, the highest points in the network; or
- (b) the nodes where the resting pressure is more likely to exceed the maximum value of 8.0 bar, for instance, the lowest points in the network (DVGW 2004).

Both requirements are to be met in every supply area.

The identification of the critical points and the monitoring of the pressure at these nodes is crucial in order to take advantage of the excess pressure in the network, which can be used for recovering the maximum energy yield, without jeopardising water supply safety.

Water loss and leakage modelling

Hydraulic modelling was also applied for predicting the potential water loss reduction by improving the pressure management in the studied WDN (Parra & Krause 2017). In this case, the volume of water loss due to background leakage was modelled in EPANET, for a fixed outlet pressure control (conventional PRV) and advanced pressure management (critical point approach). For this purpose, the flow emitter feature in EPANET was used for modelling the

relationship between pressure and leakage, as recommended in Walski *et al.* (2007) and Karadirek *et al.* (2012). Here, the flow rate Q through an orifice is described as a function of the pressure in the node as:

$$Q = CP^\gamma \quad (3)$$

where C = leakage coefficient, P = nodal pressure and γ = pressure exponent. In EPANET the pressure exponent γ is defined with the default value of 0.5, appropriate for modelling nozzles and sprinklers. Nevertheless, for modelling background leakage, a value of 0.5–2.5 is more suitable (Ulanicki *et al.* 2000; Lambert 2001; Schwaller & van Zyl 2015). In the present study, a mean value of 1.5 was chosen. This value was estimated by taking the pipe material – mainly PVC – into account and assuming most background leakage to be uniformly distributed along the supply area. For simplifying the leak modelling, the leakage was placed at a single node located at an average elevation in the district metered areas (DMA).

Experimentation and system development

The company KSB AG, in charge of the hydraulic competence in the EWID consortium, was responsible for dimensioning and providing pumps, valves and fittings for the testing installation located at the UniBwM. Two feed pumps with frequency converters and a great number of different valves were provided to mimic the actual situation within the selected WDN. The testing facilities were designed according to the boundary conditions of the network so that the hydraulic parameters, for instance, flow velocity and pressure, could be reproduced 1:1 as in the real cases (see Figure 3).

Due to its simplicity, robustness and cost-effectiveness, a standard reverse centrifugal pump was tested for the system. The PAT is located in the bypass to the main pipeline (conventional PRV) and its size (maximum flow $Q_{max} = 50$ m³/h, maximum rotational speed $n_{max} = 4,200$ revolutions per minute [rpm], rated engine power $P_{rat} = 5.5$ kW) was selected according to the flow and pressure measurements taken in the water distribution systems in June 2015. To achieve a high hydraulic flexibility, the PAT is regulated



Figure 3 | Testing plant at the UniBwM. It comprises a combination of feeding pumps and regulating valves, for generating a wide range of flows and pressures, and different measuring devices (pressure sensors and flow meters).

electronically using a frequency converter. The full replacement of the PRV with the PAT-unit was dismissed, in order to satisfy the requests of the water suppliers of providing a secure water supply at any time (e.g. power outage). Therefore, no closing valve is located in the main pipeline. In addition to the PAT-unit, a solenoid valve (SV) with an electrical drive is located in the bypass as an opening/closing device, as shown in Figure 4. During the experiments, the recovered energy is fed back into the internal energy grid.

An experimentation series during the testing phase consists of a two-hour experiment, in which a complete characteristic day in the supply network is reproduced: a

day with 24 hours is simulated in two hours, whereby five experimental minutes represent one hour of real time. During an experimental series, the dynamic characteristic consumption pattern of the analysed WDN (Figure 2) is reproduced using calibrated automatic regulating valves. Two feed pumps, used as pressure booster systems, are needed in order to reach the required inlet pressure. For pressure reduction during low flow conditions, the conventional PRV is located in the mainline as is currently the case in the real network. The hydraulics in the testing installation are monitored using redundant measurement equipment (magnetic flow meters, pressure and temperature sensors, etc.). The recorded data are collected in a central system and can be visualized on the PC in 1 to 10 second intervals. The feed pumps and the regulating valves can be operated comfortably by the user on the PC, as the complete installation is controlled by a programmable logic controller (PLC) developed and provided by SCHRAML in collaboration with the UniBwM.

Optimised pressure control

As shown in Figure 1, the approach of EWID is to implement advanced pressure management by replacing/complementing a conventional PRV with a PAT-unit for recovering energy and, at the same time, providing intelligent pressure management within the WDN. One of the challenges here is to predict the optimal target outlet

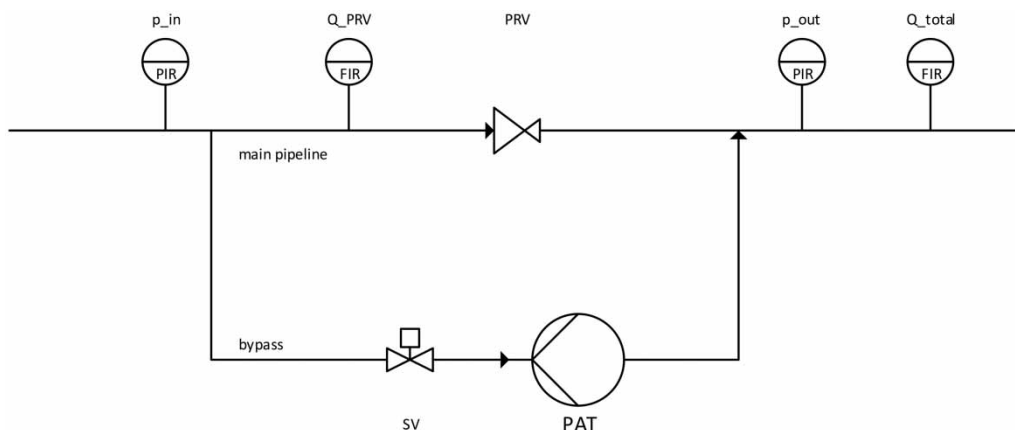

Figure 4 | Testing installation of the EWID system composed of a PRV and a PAT, located in the main pipeline and in the bypass, respectively. The volume flow and the pressure are monitored using magnetic flow meters (FIR) and pressure sensors (PIR). The recorded data are collected in a central system and can be visualized on the PC in 1 to 10 second intervals.

pressure for the pressure reducing device (PAT-unit), so that the measured pressure at one or more critical points does not exceed or fall below the limit value $p_{crit, limit}$. The proposed pressure modulation is achieved using an algorithm that takes the head loss between the PRV-PAT-manhole and the critical points, as well as the water demand, into account. A similar procedure was presented by Fantozzi for a water utility in Etnia (Fantozzi et al. 2009).

According to the Darcy Weißbach equation, the head loss h_v varies with changing demand patterns (Q) by the square. Therefore, the outlet pressure of the PAT ($p_{out, target}$) must be continually adjusted using the following equations:

$$h_v = f(Q) = aQ^2 + bQ + c \quad (4)$$

$$\frac{p_{out, target}}{\rho g} = h_{crit} - h_{PAT} + \frac{p_{crit, limit}}{\rho g} + h_v \quad (5)$$

with a , b , and c as network dependent parameters, h_{PAT} and h_{crit} [m] as the elevations at the PAT manhole and at the critical point, respectively, ρ [kg/m³] as the water density and g [m/s²] as the gravitational acceleration.

For a first approximation, the head loss (Equation (4)) was calculated using the calibrated hydraulic model for

determining a , b and c . At a later stage, during the field test, these parameters will be continuously adjusted using real-time measured data as input for the hydraulic model in EPANET.

RESULTS

Case study

In this paper, a part of the WDN of the water utility PER is presented (see Figure 5). The analysed supply area, with 1,200 inhabitants and 940 service connections, is located in a rural area in western Germany. The water consumption is mainly domestic and the unique bulk consumer is a paper factory, situated in village D. The water distribution system encompasses 27 km of water pipelines (without service connections) that are mainly manufactured from PVC and cast iron. The area shows high elevation differences, ranging from 401.0 m at the feeding tank (tank 1), down to 155.0 m at the lowest point in the supply area (in village D). To avoid too high operational pressures in the system, two PRVs are installed in villages A and B, respectively. Due to the hydraulic and geodetic situation, the system is divided into four

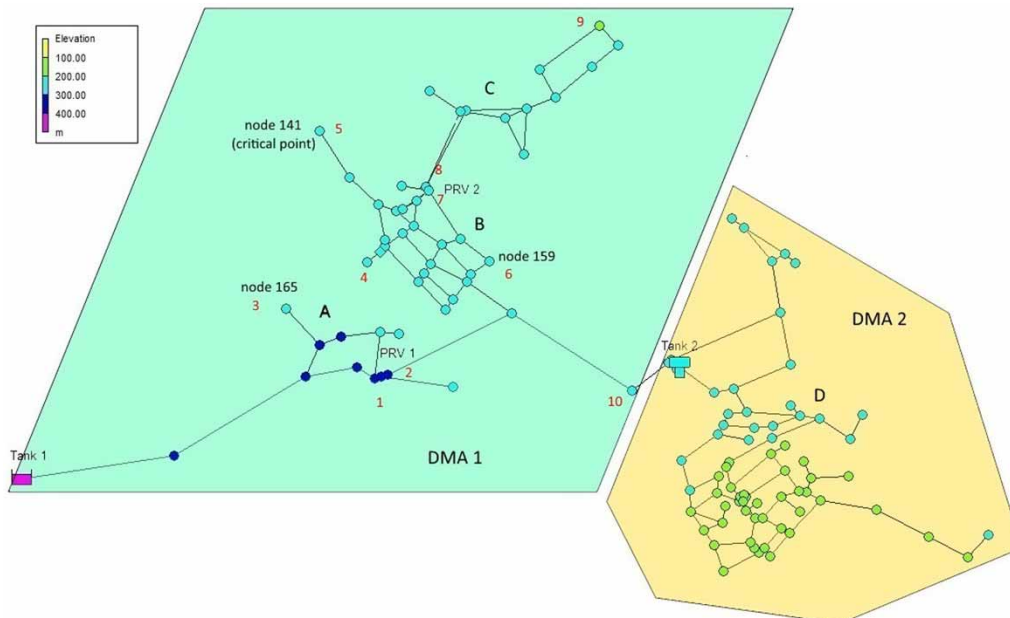

Figure 5 | Analysed WDN of the case study (PER).

pressure zones or, rather, two DMAs with storage tank 2 as the boundary between DMA 1 and DMA 2. The water supply company selected the PRV 1 to implement the PAT-system proposed by EWID, in order to improve the pressure management and the energy efficiency in the water network.

From the 9th to the 15th of June 2015 a measuring campaign was started at tank 1. Here the water outflow from tank 1 Q_{T1} and the inlet and outlet pressures at PRV 1 (p_{in} and p_{out}) were recorded simultaneously to evaluate the flow and pressure parameters in DMA 1 (see Figure 6). On average, PRV 1 reduces the inlet pressure from 9.4 to 4.0 bar with a water flow Q that varies from about 2 to 14 l/s.

Hydraulic modelling and model calibration

After the hydraulic model was established, the calibration of the model was performed by comparing the modelled and the measured data, as recommended by the DVGW (DVGW 2006). For this, the pressure head was recorded at ten second intervals using portable pressure data loggers at 10 strategic nodes in DMA 1, including possible critical points, such as the highest and lowest points in the system, during two days (7th and 8th April 2016). During this period, the water outflow from tanks and reservoirs was also recorded. The aim here was to determine the friction coefficient of the pipelines and to verify the input data. The model calibration included the performance of two artificial

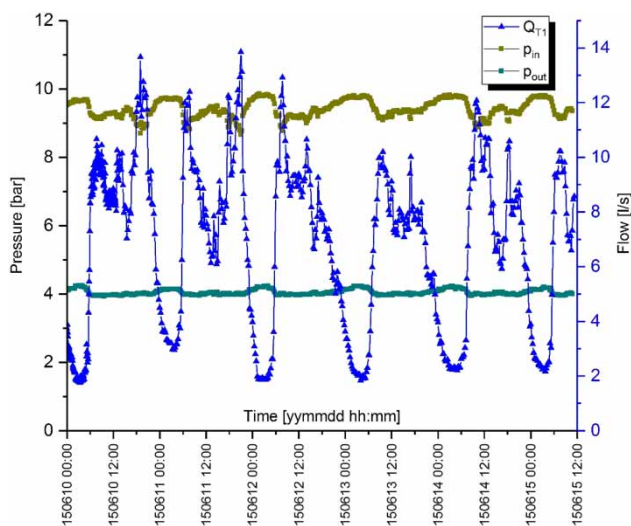

Figure 6 | Recorded outflow from tank 1 and inlet and outlet pressures at PRV 1 during the measuring campaign in June 2015.

flush events of around 25 l/s, in order to verify the head loss at the selected nodes for steady state conditions. The location of the data loggers is presented in Figure 5. During the calibration of the hydraulic model, the pipe roughness was modified by trial and error until a maximum mean error of 2 m for the pressure heads was achieved. At the end of the calibration, the pipe roughness was adjusted to the range of 1.5 to 3.5 mm depending on the pipe material (mainly PVC and cast iron). The measured and modelled data of three nodes (141, 159 and 165, corresponding to data loggers 5, 6 and 3, respectively) are shown in Supplementary Figure 1 (Figure SF1) as an example (available with the online version of this paper).

Due to the topography in the studied pilot area, the critical point was identified as the lowest point in the system, at node 141 in village B. At this point, a resting pressure of 8 bar should not be exceeded to prevent material stress and increased abrasion in the pipelines and armatures (DVGW 2004). According to the measurements performed for the calibration of the hydraulic model, the pressure at node 141 had exceeded 10 bar. To address this issue, a further pressure reduction at PRV 1 was urgently recommended. In agreement with the water supply company, the outlet pressure was not to fall below 1 bar in order to satisfy the water supply in the neighbouring areas. Table 1 presents a summary of the mean hydraulic data for the presented case study.

Water loss reduction due to advanced pressure management

To evaluate the impact of the proposed pressure management strategy at PRV 1 in terms of water loss reduction, the pressure at the critical point was simulated using EPANET for the advanced pressure management (critical point approach), and compared to the current situation ($p_{out} = 4$ bar) and to a further pressure reduction (fixed outlet, $p_{out} = 2$ bar). In this simulation, the optimal outlet pressure

Table 1 | Daily mean flow and pressure parameters for case study

	Q l/s	p_{in} bar	p_{out} bar	Δp bar	p_{crit} bar
Actual	7	9.4	4.0	5.4	10.0
Target			1.0	8.4	<8.0

Table 2 | Summary of predicted pressures and water loss savings in DMA 1 for one characteristic day determined by hydraulic modelling and leak simulation (Parra & Krause 2017)

	Current fixed outlet PRV	Enhanced fixed outlet PRV	Advanced pressure management
Outlet pressure PRV 1	4 bar	2 bar	0.8–1 bar
Mean pressure at critical point	10.9 bar	9.1 bar	8.0 bar
Real water losses Q_{RL}	0.50 l/s	0.36 l/s	0.28 l/s
Water loss reduction ΔQ_{RL}		0.14 l/s	0.22 l/s
		4,415 m ³ /year	6,938 m ³ /year
Water loss reduction in %		28%	44%

curve (p_{out_dyn}) for one day was calculated using the calibrated model so as to achieve a constant pressure of 8 bar at node 141 at every hour of the day (see Figure SF2, available online). The target outlet pressure curve was implemented using the CONTROLS feature in EPANET.

The amount of water loss reduction, simulated for one day using the flow emitter feature in EPANET and summarized in Table 2, shows that, assuming all real water losses (0.12 m³/(h*km)) were background leakages (pressure exponent of 1.5), switching from the fixed outlet to the critical point approach provides additional water savings of 16% (Parra & Krause 2017).

Potential analysis and experimentation results

For the first design of the PAT system (experimentation), the flow and the pressure data collected during the measuring campaign in June 2015 in the studied water network were taken into consideration. Nevertheless, analysis of the seasonal variations of flow rates and pressure is urgently recommended for achieving more accurate results. In Figure 7, the operating range of the selected PAT for the presented case study is shown: The points represent the measured data recorded at tank 1 (flow) and at the PRV manhole in June 2015. The dashed lines represent the differential pressure range and the allowed volume flow that was selected for the turbine. The system (SV and consequently the PAT) is controlled by the PLC and was configured as follows:

- $Q < 4.6$ l/s: PRV is in full operation, SV is closed, PAT is not in operation.
- 4.6 l/s $< Q < 8.3$ l/s: if the flow exceeds 4.6 l/s, the SV opens and the PAT starts to operate. There is no flow through the main pipeline (PRV).

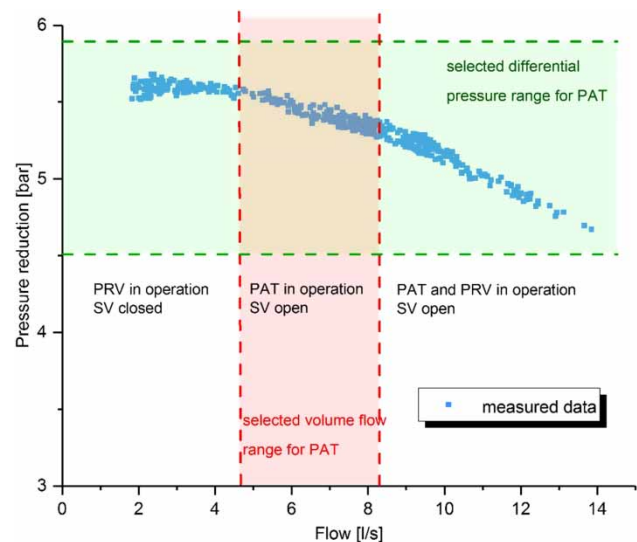
**Figure 7** | PAT operation range selected for its dimensioning, according to the recorded data in June 2015.

- $Q > 8.3$ l/s: the maximum design flow for the PAT is reached, so that both the PRV and the turbine are in operation (SV is fully open). The PAT runs at full capacity with 8.3 l/s.

The experiments on the testing installations served, on the one hand, for the monitoring of the actual energy yield and, on the other hand, for testing the interaction between the PRV and the PAT in combination with the proposed pressure management strategy (critical point approach). Nevertheless, due to the limited space capacities in the installation, the analysed case study could not be fully reproduced. During the experimentation, the pressure loss between the PAT-unit and the critical point, due to friction, was represented locally with a slide valve in an almost closed position. The critical point measurement was placed directly after the slide valve.

During the experimental series, the proposed intelligent pressure management was tested. Here, the pressure modulation was performed automatically by the PLC. The pressure value at the critical point and the flow (both monitored in real time) were both taken into account. The PLC was responsible for calculating the target rotation of the PAT in real time from a range between 2,000 and 4,200 rpm, so that the pressure at the critical point did not fall below a defined value. For this purpose, the head loss h_v was previously calculated and $Q_{out,target}$ was set according to Equations (4) and (5). During the testing phase, a pressure limit of 2.5 bar at the critical point was chosen.

In Figure 8, the recorded parameters of flow, pressure and total energy yield for a representative experimental series of two hours are shown. In the graph, the negative energy

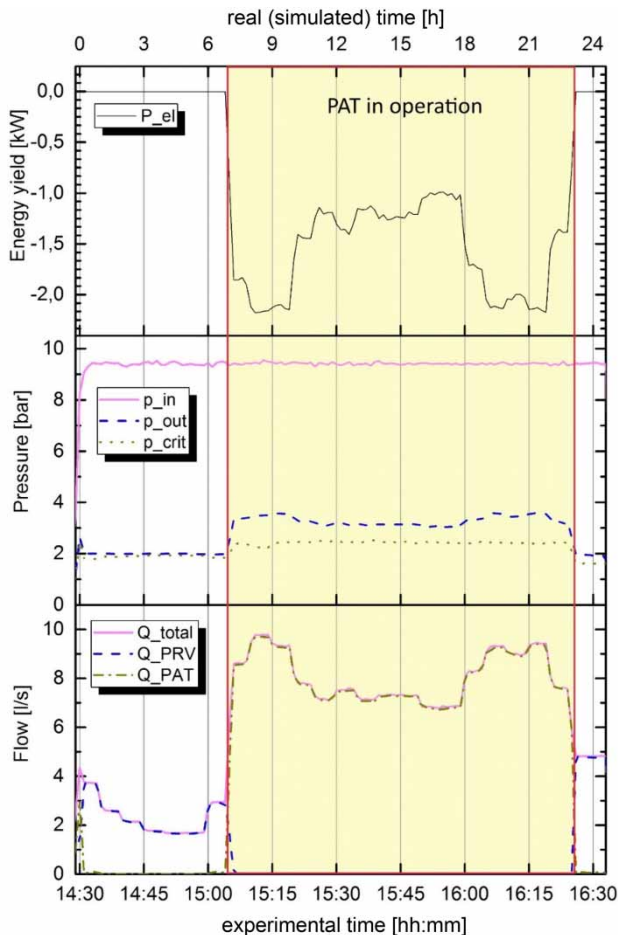

Figure 8 | Results of energy recovery and intelligent pressure management for a two-hour experiment (bottom axis) representing a characteristic day of 24 h in the case study (top axis).

yield indicates energy recovery. A day (24 hours) is simulated using the characteristic pattern in Figure 2 and reproduced in two hours, where five experimental minutes represent one hour in real time. In Figure 8, the bottom axis represents the experimental time and the top axis represents the real (simulated) time at the analysed WDN. As shown in Figure 2, the demand peaks take place at 8 am and 9 pm.

As shown in Figure 8, the PAT was in operation for 17 hours from 7 am to 11 pm, when a flow of 4.6 l/s or higher was reached. Outside of this operation range, the pressure management was performed by the PRV. During the PAT operation, the pressure at the critical point was constantly maintained at 2.5 bar, while the PAT's outlet pressure varied dynamically according to the demand. Due to a relatively low variability in the demand profile, the outlet pressure shows quite a narrow range.

Furthermore, the actual net efficiency e_{net} of the system was calculated for the presented experiment using the following equation:

$$e_{net} = \frac{P_{prod}}{Q_{PAT} * (p_{in} - p_{out}) * \rho * g} \quad (6)$$

with P_{prod} [W] as the produced energy, Q_{PAT} [m³/s] as the water flow through the PAT (or rather the entire discharge in the system) and $(p_{in} - p_{out})$ [m] as the entire piezometric difference in the system, including all hydraulic losses. The results are presented in Figure 9.

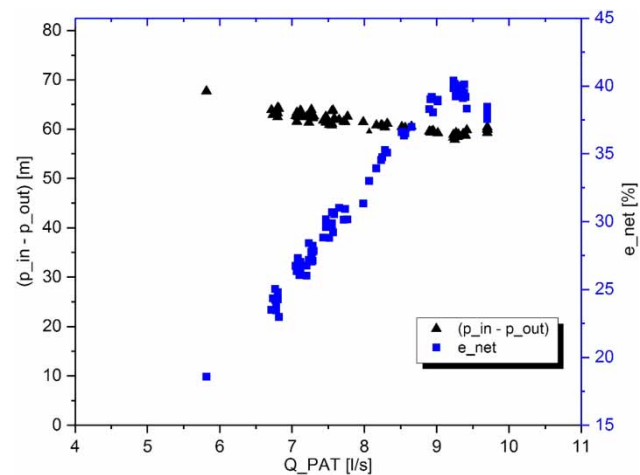

Figure 9 | Net efficiency of tested PAT system under different flow rates and pressure differences, calculated experimentally.

For the presented experimental series, a maximum of 2.3 kW electrical energy was recovered and fed back into the grid when the turbine was operating under full load ($Q_{PAT}=9.7$ l/s and $p_{out}=6.1$ bar) with a maximum total net efficiency of approximately 40%. Furthermore, 26 kW electrical energy were recovered in total during the presented characteristic day, if the PAT is in operation for 17 hours. This would represent an energy yield of approximately 9,500 kW per year. As shown in Figure 9, the total net efficiency varies from 25% to 40% depending on the flow and the pressure difference at the inlet and outlet of the system.

In general, for enhancing the performance of the system, the following factors might be taken into consideration:

- A better dimensioning of the turbine should be carried out. The PAT for the testing facility was dimensioned according to the recorded data on the analysed WDN ($\Delta p_{actual}=4.5\text{--}5.8$ bar). Nevertheless, the results of the calibrated hydraulic model confirmed that a further pressure reduction at the PRV-PAT-manhole is possible ($\Delta p_{target}=8.4$ bar). For this reason, the PAT's pressure operating range for the field tests (shown in Figure 7) will be adjusted accordingly. Additionally, the flow range for the PAT will be adjusted taking the seasonal variations during a minimum of one year into consideration.
- The efficiency of the PAT might be optimized, for example, by optimizing the PAT's geometry, such as the impeller or the housing design.
- The reduction of the electrical losses of the system can be performed by selecting a high-performance frequency convertor. Furthermore, alternatives for the electric regulation of the PAT (rotational variability) for variable operating conditions should be considered. A possible option is hydraulic regulation, such as a series-parallel hydraulic circuit as proposed by Carravetta *et al.* (2013). In this study, the hydraulic regulation was found to be more flexible, efficient and economical than the electrical system.
- The hydraulic energy losses in the installation (fittings, cross section changes, pipe bends, etc.) can be reduced to achieve better inflow conditions (uniform and, if possible, free of swirl areas).

- The selection of a micro-turbine of higher hydraulic performance should be considered. A promising option might be pressurized cross-flow turbines, as proposed in Carravetta *et al.* (2014) and Sammartano *et al.* (2016). These turbines are capable of self-adapting their inner geometry according to the actual discharge for achieving a high hydraulic performance at variable flows. Nevertheless, further studies on the verification of the system on a real WDN and a profitability analysis are needed, as well as a study of its performance in combination with a PRV.

CONCLUSIONS

In the present study, the combination of a PRV with a reverse centrifugal pump (PAT) for intelligent pressure management was analysed in terms of performance, energy recovery and potential water loss reduction. During the development of the PRV-PAT-unit, the proposed system was tested on an experimental installation, capable of simulating the hydraulic conditions of a real WDN at the same scale. During the experimentation, the system was able to successfully maintain constant pressure at the critical point of the system at variable discharges. Here, up to 2.3 kW energy were recovered with a maximum total net system efficiency of 40%. The performance of the proposed PAT-PRV-system might be enhanced by improving the dimensioning and efficiency of the PAT, reducing the electrical and hydraulic losses in the installation, or by selecting a turbine of higher efficiency. The implementation of the proposed intelligent pressure management was found to increase the water savings by up to 16% compared to the conventional pressure management strategy (fixed outlet pressure). As suggested in Carravetta *et al.* (2014), the large variability of the hydraulic parameters of flow and pressure and the limited available recovered power should be considered before the installation of an energy recovery unit in a water distribution system. For a proper design of the PAT, long-term seasonal variations of the flow rates and water pressures should be evaluated. The authors recommend at least yearly analyses, including a prognosis of future water demand and its variations.

In general, the implementation of the proposed intelligent pressure management strategy using PATs will be feasible in supply networks that have large differences between night-time and day-time water demands. In areas with low consumption differences, the additional savings might be marginal. Both the benefits and the investment costs, as well as the characteristics of the WDN, have to be weighed up. Manholes where a PRV is already placed might be especially attractive, if the size of the manhole is large enough to place a PAT, as construction costs influence the profitability analysis of PAT systems strongly (Samora *et al.* 2016). Additionally, a higher yield might be achieved by selecting the best location for the PRV-PAT-system, as proposed by Giugni *et al.* (2013) and Samora *et al.* (2016).

ACKNOWLEDGEMENTS

The EWID consortium is composed of the chair of Sanitary Engineering and Waste Management of the University of the Federal Armed Forces Munich (UniBwM) as project coordinator, KSB Aktiengesellschaft responsible for the hydraulic competence, Schraml GmbH in charge of the automation and telecommunication, Dr Krätzig Ingenieurgesellschaft mbH in charge of the controlling system, and the water utilities AWA-Ammersee Wasser- und Abwasserbetriebe gKU and Wasserversorgungszweckverband Perlenbach responsible for providing operational experience and technical assessment for the field tests. The research project is sponsored by the German Federal Ministry of Education and Research in the framework of the programme Future-oriented Technologies and Concepts for an Energy-efficient and Resource-saving Water Management – ERWAS. The project commenced in April 2014 and concluded in June 2017.

REFERENCES

- BDEW 2015 *Branchenbild der deutschen Wasserwirtschaft*. Neue Ausg. Wirtschafts- u. Verlagsges. Gas u. Wasser, Bonn.
- Carravetta, A., del Giudice, G., Fecarotta, O. & Ramos, H. 2013 *PAT design strategy for energy recovery in water distribution networks by electrical regulation*. *Energies* **6** (1), 411–424. DOI: 10.3390/en6010411.
- Carravetta, A., Fecarotta, O., Sinagra, M. & Tucciarelli, T. 2014 *Cost-benefit analysis for hydropower production in water distribution networks by a pump as turbine*. *J. Water Resour. Plann. Manage.* **140** (6), 4014002. DOI: 10.1061/(ASCE)WR.1943-5452.0000384.
- DVGW 2003 Arbeitsblatt W 392: Wasserverlust in Rohrnetzen – Ermittlung, Überwachung, Bewertung, Wasserbilanz, Kennzahlen. Wirtschafts- u. Verlagsges. Gas u. Wasser, Bonn.
- DVGW 2004 Arbeitsblatt W 400-1: Technische Regeln Wasserverteilungsanlagen (TRWV); Teil 1: Planung. Wirtschafts- u. Verlagsges. Gas u. Wasser, Bonn (October 2004).
- DVGW 2006 Arbeitsblatt GW 303-1: Berechnung von Gas- und Wasserrohrnetzen – Teil 1: Hydraulische Grundlagen, Netzmodellierung und Berechnung. Wirtschafts- u. Verlagsges. Gas u. Wasser, Bonn.
- Fantozzi, M., Calza, F. & Kingdom, A. 2009 Experience and results achieved in introducing District Metered Areas (DMA) and Pressure Management Areas (PMA) at Enia utility (Italy). In: *IWA International Specialised Conference on Water Loss*, Cape Town, South Africa, 26–29 April 2009.
- Giugni, M., Fontana, N. & Portolano, D. 2009 Energy saving policy in water distribution networks. In: *International Conference on Renewable Energies and Power Quality (ICRE PQ'09)*, Valencia, Spain, 15–17 April 2009. European Association for the Development of Renewable Energies, Environment and Power Quality.
- Giugni, M., Fontana, N. & Ranucci, A. 2013 *Optimal location of PRVs and turbines in water distribution systems*. *J. Water Resour. Plann. Manage.* **140** (9), 60140041–60140046. DOI: 10.1061/(ASCE)WR.1943-5452.0000418.
- GIZ and VAG 2011 *Guidelines for Water Loss Reduction. A Focus on Pressure Management*. Available from: <https://www.giz.de/fachexpertise/downloads/giz2011-en-guideline-water-loss-reduction.pdf>.
- Haakh, F., Holmer, F. & Nill, A. 2013 Energieeffizienz in der Fernwasserversorgung am Beispiel der Landeswasserversorgung. Beitrag 5. In: *LW-Schriftenreihe 2013*, pp. 54–66.
- Hamilton, S. & McKenzie, R. S. 2014 *Water Management and Water Loss*. IWA Publishing, London, UK.
- Jernigan, W. 2016 The 3 Trillion-Gallon Leak – Where's Our Water? Available from: <https://www.wateronline.com/doc/the-trillion-gallon-leak-where-s-our-water-0001>.
- Karadirek, I. E., Kara, S., Yilmaz, G., Muhammetoglu, A. & Muhammetoglu, H. 2012 *Implementation of hydraulic modelling for water loss reduction through pressure management*. *Water Resources Management* **26** (9), 2555–2568. DOI: 10.1007/s11269-012-0032-2.
- Kramer, M. & Wieprecht, S. 2012 Untersuchungen zum Einsatz von Kleinturbinen in der Trinkwasserversorgung. In: *Wat + gat (spezial)* Tagungsband 2.
- Lambert, A. 2001 What do we know about pressure-leakage relationships in distribution systems? In: *IWA International*

- Specialised Conference: System Approach to Leakage Control and Water Distribution Systems Management*, Brno, Czech Republic, 16–18 May 2001.
- Nowak, D., Bortz, M. & Roclawski, H. 2015 [Decision support for the design and operation of water supply systems](#). *Procedia Engineering* **119**, 442–449. DOI: 10.1016/j.proeng.2015.08.852.
- Parra, S. & Krause, S. 2017 [Pressure management by combining pressure reducing valves and pumps as turbines for water loss reduction and energy recovery](#). *International Journal of Sustainable Development and Planning* **12** (1), 89–97.
- Ramos, H. M., Mello, M. & De, P. K. 2010 [Clean power in water supply systems as a sustainable solution: from planning to practical implementation](#). *Water Science & Technology: Water Supply* **10** (1), 39–49. DOI: 10.2166/ws.2010.720.
- Rossman, L. 2000 *EPANET 2, Users Manual*.
- Sammartano, V., Sinagra, M. & Tucciarelli, T. 2016 [Banki-Michell micro-turbines for energy production and pressure regulation in water distribution networks](#). In: *Proceedings of 4th IAHR Europe Congress*, Liege, Belgium, 27–29 July 2016.
- Samora, I., Manso, P., Franca, M., Schleiss, A. & Ramos, H. 2016 [Energy recovery using micro-hydropower technology in water supply systems. The case study of the City of Fribourg](#). *Water* **8** (8), 344. DOI: 10.3390/w8080344.
- Schwaller, J. & van Zyl, J. E. 2015 [Modeling the pressure-leakage response of water distribution systems based on individual leak behavior](#). *J. Hydraul. Eng.* **141** (5), 4014089. DOI: 10.1061/(ASCE)HY.1943-7900.0000984.
- Sitzenfrei, R., Berger, D. & Rauch, W. 2015 [Design and optimization of small hydropower systems in water distribution networks under consideration of rehabilitation measures](#). *Urban Water Journal* 1–9. DOI: 10.1080/1573062X.2015.1112410.
- Statista 2016 [Wasserverluste in der öffentlichen Wasserversorgung in Deutschland von 1999 bis 2013](#). Statista. Available from: <http://de.statista.com/statistik/daten/studie/155684/umfrage/wasserverluste-in-der-oeffentlichen-wasserversorgung-seit-1991/> (accessed 20 April 2016).
- Ulanicki, B., Bounds, P. L. M., Rance, J. P. & Reynolds, L. 2000 [Open and closed loop pressure control for leakage reduction](#). *Urban Water* **2** (2), 105–114. DOI: 10.1016/S1462-0758(00)00048-0.
- Walski, T. M., Chase, D. V., Savic, D., Grayman, W., Beckwith, S. & Koelle, E. 2007 *Advanced Water Distribution Modeling and Management*. 1st edn. Bentley Institute Press, Exton, PA.

First received 23 December 2016; accepted in revised form 10 July 2017. Available online 25 July 2017