

Pilot study on nanofiltration membrane in advanced treatment of drinking water

Huiping Li, Yan Chen, Jian Zhang and Bingzhi Dong 

ABSTRACT

In this study, nanofiltration (NF) was used to further treat the water from the disinfection process of a drinking water treatment plant (DWTP). The results indicate that the NF process reduced the dissolved organic carbon (DOC) by 92.87%, UV absorbance at 254 nm (UVA_{254}) by 88.68%, conductivity by 94% and total dissolved solids by 94.49%. The removal efficiencies of trihalomethanes (THMs), 2-methylisoborneol (2-MIB) and trans-1,10-dimethyl-trans-9-decalol (geosmin) were also evaluated for both the DWTP and NF treatment processes. High-performance size-exclusion chromatography (HPSEC) analysis, three-dimensional excitation–emission matrix (3D-EEM) fluorescence spectroscopy and parallel factor (PARAFAC) analysis were applied to characterize the changes in different organic compounds in each process. A correlation analysis was carried out for samples of the raw water, feed water and permeate water to determine the correlations between the maximum fluorescence intensities (F_{\max}) of the PARAFAC components and the DOC, UVA_{254} and high specific UV absorbance (SUVA) of the samples. The results showed that a significant correlation ($p < 0.01$) existed between UVA_{254} and the F_{\max} of the three PARAFAC components as well as between DOC and F_{\max} .

Key words | high quality drinking water, nanofiltration, PARAFAC, trihalomethanes (THMs)

Huiping Li

Yan Chen (corresponding author)

Jian Zhang

School of the Environment and Municipal Administration,
Lanzhou Jiaotong University,
Lanzhou 730070,
China
E-mail: xiaojingmama@163.com

Bingzhi Dong 

State Key Laboratory of Pollution Control and Resource Reuse, College of Environmental Science and Engineering,
Tongji University,
Shanghai 200092,
China

INTRODUCTION

The life quality of the Chinese people has been improved significantly in the past few decades, and this can be related to the improvement in their drinking water quality. Drinking water is one of the essential substances in daily life; thus, its quality continues to gain increasing attention. At present the drinking water treatment plants (DWTPs) in China are usually made up by the coagulation–sedimentation–rapid sand filtration–disinfection process. However, such technologies result in poor removal efficiency for typical organic matter such as taste and odour compounds (T&O) (Bruce *et al.* 2002), disinfection by-product precursors (DBPs) (Zheng *et al.* 2018), antibiotics and endocrine disruptors (Chen *et al.* 2013). Thus, the above water treatment process cannot fulfil the increased stringency of drinking water regulations and further improve the quality of drinking water. The most common T&O compounds are nontoxic, but

they affect the taste of drinking water even at extremely low concentrations (Srinivasan & Sorial 2011). Meanwhile, the DBPs formed during the chlorination procedures of drinking water can greatly harm human health (Nazir & Khan 2006), and the presence of antibiotics and endocrine disruptors in the water also poses a severe risk to the human endocrine system (Snyder 2008; Mo *et al.* 2017). Therefore, researching and exploring more efficient drinking water treatment technologies to provide people with healthier and more sanitary drinking water is one of the main research goals at present.

Many studies have shown that including an ozone bioactive-carbon (O_3 -BAC) process after the rapid sand filtration can effectively improve the drinking water quality (Yang *et al.* 2015). Using O_3 -BAC treatment, Liao *et al.* (2013) significantly improved the reduction of COD_{Mn} , UV

absorbance at 254 nm (UVA₂₅₄) and dissolved organic carbon (DOC) in water by approximately 31%, 43.3% and 45.5%, respectively. Faruqi *et al.* (2018) and Chen *et al.* (2019) also employed O₃-BAC to remove 2-methylisoborneol (2-MIB) and geosmin occurring in water. The advanced treatment also has a significant removal effect on the DBPs in drinking water (Liao *et al.* 2019). However, the actual application of the O₃-BAC process also features some disadvantages: the problem of microorganism leak in the BAC filter affects the water quality (Lu *et al.* 2011). When higher concentrations of bromide are present in the water, the formation of bromate (BrO₃⁻) from bromide (Br⁻) oxidation during the ozonation process will introduce unwanted substances into the drinking water (Yang *et al.* 2015). The activated carbon adsorbent can become saturated, decreasing the treatment effect. In a previous study, compared with the new BAC filter, the old BAC filter was found to remove fewer typical nitrogenous DBPs (Zheng *et al.* 2018).

Membrane technology is an emerging drinking water treatment technology employed in recent years. The commonly used membrane technologies are microfiltration, ultrafiltration (UF), nanofiltration (NF) and reverse osmosis (RO), with descending order of membrane pore sizes (Gupta & Ali 2013). Compared with the traditional and advanced treatment processes, membrane technology has many advantages such as small footprints, a high degree of automation, easy management, eco-friendliness and stable quality of the treated water (Ahsan & Imteaz 2019). Nanofiltration,

featuring pore sizes between those of UF and RO membranes, is a promising technology characterized by higher removal efficiency than UF but requiring lower operating pressure than RO. Nanofiltration has also been found to exhibit a significant removal effect on typical organics in drinking water, such as odorant substances, DBPs and endocrine disruptors (Yüksel *et al.* 2013; Dubowski *et al.* 2018). Several pilot and bench-scale studies have evaluated the effect of the NF process for drinking water treatment and found that the NF system can consistently provide higher-quality water (Chon & Cho 2016; Gonzalez *et al.* 2019).

The current study mainly evaluated the removal effect of NF membranes on typical organics such as odorants and trihalomethanes (THMs) in municipal tap water. In addition, other water quality indicators, including conductivity, turbidity, the removal effects of DOC and UVA₂₅₄, were also analysed. Meanwhile, the removal effect of NF on organic matter with different characteristics was also explored through excitation–emission matrix (EEM) spectroscopy and high-performance size-exclusion chromatography (HPSEC).

MATERIALS AND METHODS

Pilot system

The pilot unit for this study was developed in the Suzhou Industry District Drinking Water Treatment Plant, China. As shown in Figure 1, the unit comprised the treatment

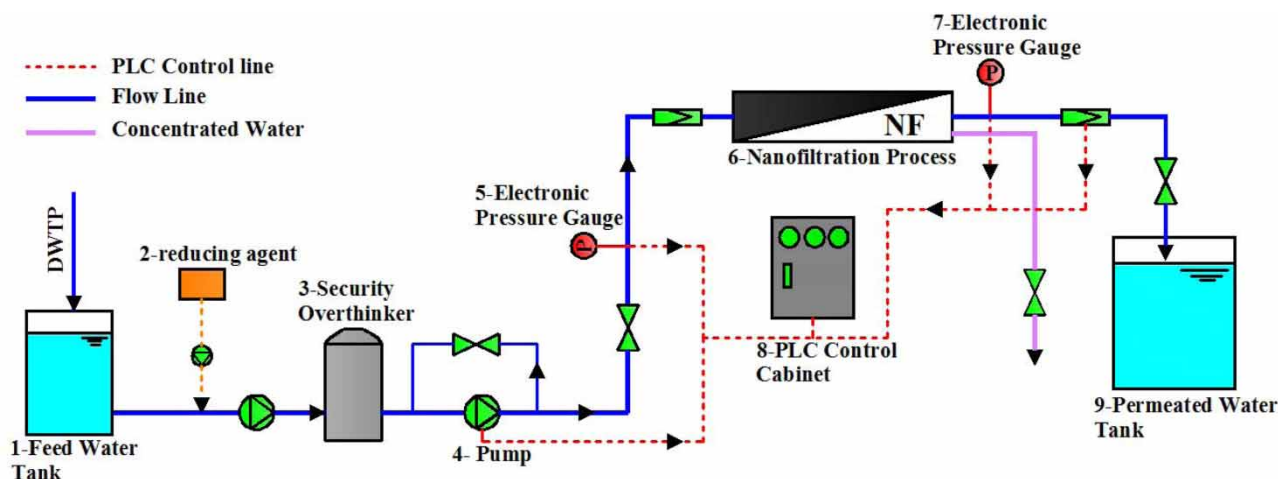

Figure 1 | A schematic diagram of the pilot-plant system.

process of the DWTP and an NF system. Surface water from Lake Tai was first treated by the coagulation–sedimentation–rapid sand filtration and disinfection process, and then, the obtained water was directly sent into an NF pilot system. A commonly used NF membrane NF 90 (DOW Filmtec, Midland, MI) was selected for this research. The properties of the virgin NF 90 membrane are summarized in Table 1 (Vatankhah *et al.* 2018). Since the feed water was disinfected by chlorine, a reducing agent was added to prevent the NF membrane from being damaged by residual chlorine in the water, and a security filter was set to remove particulates. The recovery rate was set to 29.80%, and the feed water pressure was set to 3.1 bar for continuous two months running. The initial permeate flux of water was 21.17 (L/m²·h).

Analytical methods

DOC was measured using a total organic carbon (TOC) analyzer (Aurora 1030 W, USA); UVA₂₅₄ was determined using a UV-Vis spectrophotometer (Evolution 300, Loveland, USA); conductivity and total dissolved solids (TDS) were measured using a conductivity meter (DDS-307A, INESA instrument, China). Turbidity was measured with a turbidimeter (2100N, Hach Company, Loveland, USA). The concentration of 2-MIB and geosmin were measured by gas chromatography–mass spectrometry (GC-MS, 7890-7000C, Agilent, USA); the THMs of samples were determined by gas chromatography (7890A, Agilent, USA).

Table 1 | Manufacturing properties of NF90 membrane

Parameter	NF90
NaCl removal rate	85–95%
MgSO ₄ removal rate	>97%
Material	Polyamide, TFC
Molecular weight cut-off (g/mol)	200–300
Maximum pressure (bar)	41
Maximum temperature (°C)	45
pH	3–10
Hydraulic resistance (m ⁻¹), 10 ¹³	4.0–7.7
Contact angle	63.2°
Free chlorine tolerance	<0.1 ppm

PARAFAC modelling

The 3D-EEM fluorescence spectra of samples of the raw water, feed water and permeated water were determined with a Hitachi Fluorescence Spectrophotometer-7100 (Japan) at room temperature (25 ± 2 °C), and the pH values of diluted samples were adjusted to 7.0 ± 0.1. Excitation–emission matrix scans were collected by scanning over emission (Em) wavelengths of 250–550 nm at 2 nm intervals and excitation (Ex) wavelengths of 200–400 nm at 2 nm intervals, with the scanning speed at 12,000 nm/min. The fluorescence signal of the pure water (Milli-Q water) was subtracted from the EEMs to remove Raman scatter peaks. The integrated area under the Raman scatter peak (Ex = 350 nm, Em = 381–426 nm) of the pure water was used for Raman unit (RU) normalization (Murphy *et al.* 2013). After EEM data pretreatment, a total of 66 fluorescence EEM spectra of water samples during the water pilot treatment were used for parallel factor (PARAFAC) analysis using MATLAB 7.1 based on the DOMFluor toolbox (Murphy *et al.* 2008). Only four samples were identified and removed using leverage comparison, and PARAFAC models with two to seven components were generated. Finally, a model of the four components was determined for further analysis using the split-half method.

High-performance size-exclusion chromatography analysis

The molecular weight (MW) distribution of TOC and the characteristics of UV fractions were examined using an HPSEC analysis instrument (Waters 4689, USA) connected with a Sievers900 online TOC analyser (GE, USA) and an online UV absorbance detector set at a wavelength of 254 nm (2,489 UV/VIS detector, Waters, USA).

RESULTS AND DISCUSSION

Effects of water plant and NF system on water quality improvement

A comprehensive sampling campaign was conducted from 7 April to 12 June 2019, throughout which the pilot

process was continuously operated (over two months). Table 2 presents a summary of the mean and standard deviation measurements of the UVA_{254} , DOC, specific UV absorbance (SUVA), conductivity, TDS and turbidity of the total 63 water samples. The source water was moderate in DOC (3.78 mg/L) and low in UVA_{254} (0.0525 cm^{-1}), SUVA ($1.394 \text{ L mg}^{-1} \text{ m}^{-1}$) and turbidity. During the experiment, the average conductivity and TDS of the raw water were 373.4 mS/cm and 186.7 mg/L, respectively. The UVA_{254} , DOC and turbidity of the water were apparently reduced by the DWTP treatment, but the treatment had no effect on the conductivity and TDS. The conductivity and TDS of the finished water were higher than those of the raw water due to the addition of a coagulant in the coagulation process. However, the NF process could effectively reduce not only the organic matter but also the hardness.

As shown in Figure 2, for the NF treatment, the total percentage reductions in UVA_{254} , DOC, SUVA, cond. and TDS were 95.90%, 92.06%, 65.70%, 94.59% and 94.61%, respectively. The DWTP yielded a 31.71% reduction in UVA_{254} , 20.59% for DOC, 17.05% for SUVA, -2.04% for conductivity, -2.13% for TDS and 96.54% for turbidity. The removal efficiency of UVA_{254} was higher than that of DOC. This indicates that humic substances were removed more easily than the non-humic portion for the same DOC levels. The efficient reduction in conductivity and TDS by the NF membrane means a decrease in the ion concentration of the water, which can improve the taste of drinking water. Different from the conventional process, NF features membranes of very tiny pore sizes; thus, pollutants larger than the membrane pore size can be physically removed. Therefore, the NF process was efficient in the separation of impurities in water, and its effect on the improvement of drinking water quality was unmatched by the conventional process.

Removal effect of odour substances and THMs in drinking water

During the experiment, the removal effects for two typical odorant substances, 2-MIB and geosmin, were evaluated during the algal bloom time of Lake Tai. As can be seen in Figure 3(a), after treatment by the DWTP, the concentrations of 2-MIB and geosmin were reduced to 18.66 ng/L and 0.945 ng/L, respectively, with removal efficiencies of 54.63% and 47.35%, respectively. The conventional treatment could not reduce the 2-MIB to below the odour threshold concentration (9 ng/L). However, the geosmin content in the raw water was much lower than its threshold concentration (4 ng/L) (Kim *et al.* 1997). The NF process exhibited removal rates of 75.69% and 58.20% for 2-MIB and geosmin, respectively, with the concentrations reduced to 4.54 ng/L and 0.39 ng/L, respectively. The MW of 2-MIB is 168 Da, and that of geosmin is 182 Da; they are both smaller than the maximum MW cut-off of the selected NF membrane (200 Da) in this experiment. The removal of substances smaller than the NF membrane pore size mainly relies on the Donnan and dielectric effects and relates to the characteristics of the target pollutants (Cheng *et al.* 2012). The hydrophobicity/hydrophilicity (octanol–water partition coefficient, K_{OW}) and charge (neutral or negative) of pollutants can affect the removal efficiency of the NF membrane (Amy *et al.* 2005).

As shown in Figure 3(b), after the disinfection process by the DWTP, the formation contents of CHCl_2Br , CHBr_3 , CHCl_3 and CHClBr_2 were 17.87, 13.80, 9.17 and 7.53 $\mu\text{g/L}$, respectively. Trihalomethanes are formed due to the chlorination of water-containing organic compounds, principally humic and fulvic compounds (Waniek *et al.* 2002). The DBPs could not be removed effectively by the coagulation–sedimentation–rapid sand filtration process. After the treatment by NF, the concentrations of CHCl_2Br ,

Table 2 | Water quality of raw water and treated water

Waters	$UVA_{254} (\text{cm}^{-1})$	DOC (mg/L)	SUVA ($\text{L mg}^{-1} \text{ m}^{-1}$)	Cond. (mS/cm)	TDS (mg/L)	Turb. (NTU)
Raw	0.0525 ± 0.004	3.78 ± 0.24	1.394 ± 0.12	373.4 ± 3.88	186.7 ± 2.11	9.69 ± 7.94
DWTP	0.0356 ± 0.004	2.99 ± 0.16	1.202 ± 0.16	381.3 ± 5.16	190.87 ± 2.59	0.172 ± 0.07
NF	0.0012 ± 0.002	0.21 ± 0.59	0.692 ± 0.59	20.6 ± 7.43	10.28 ± 3.77	0.049 ± 0.01

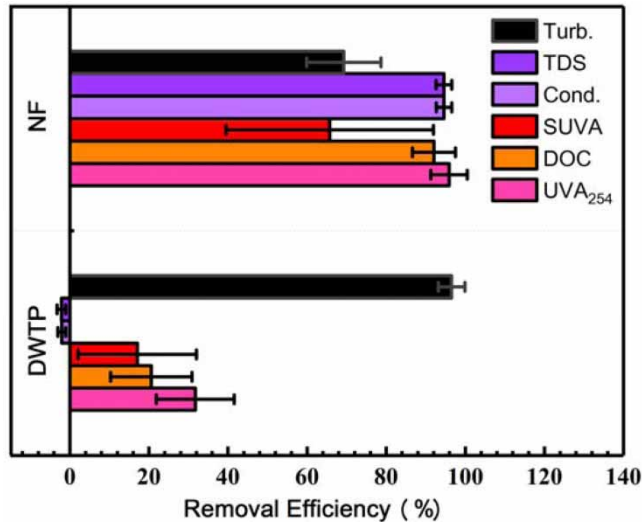

Figure 2 | Reduction in UVA₂₅₄, DOC, SUVA, Cond., TDS and Turb.

CHBr₃, CHCl₃ and CHClBr₂ were 11.79, 9.10, 5.64 and 4.77 µg/L, corresponding to removal efficiencies of 34.02%, 34.06%, 38.49% and 36.65%, respectively. The MWs of CHCl₂Br, CHBr₃, CHCl₃ and CHClBr₂ are 163.8, 252.8, 119.4 and 208.3 Da, respectively. The removal rate shows that no correlation exists between the removal effect for the four kinds of THMs and their MWs. The pore size of the NF membrane employed in this study is believed to be larger than the target THMs; therefore, the NF process could not contribute to a high reduction. The overall lower DBP rejection by the NF appears to be related

to size exclusion as well as solute–membrane affinity (Doederer *et al.* 2014).

However, the average concentrations of THMs in permeate water were substantially reduced after the NF treatment process. Disinfection is the last process in any water treatment plant. Therefore, if the DBP precursors cannot be effectively removed by the pretreatment process, they will react with chlorine. With the advantages of the flexibility of water plant design, NF can be used for the secondary improvement of drinking water at the end of the pipe network.

Changes in MW distributions of DOC and UVA₂₅₄

Figure 4 shows the MW distribution of natural organic matter (NOM) for different fractions based on DOC and UVA₂₅₄ measurements of raw water, feed water and permeate water. It can be found that the MWs of organic matter components in the raw water were mainly distributed between 200 Da and 30 kDa, and the peak positions of DOC and UVA₂₅₄ appear at 3 kDa and 10 kDa, respectively. Generally, UVA₂₅₄ represents the compounds whose molecular weights are larger than 3 kDa (Song *et al.* 2010). The water plant process could effectively remove organic matter components with MWs greater than 1 kDa, and DOC fractions of MWs less than 1 kDa were also partially removed, which can be attributed to their oxidative degradation by chlorine after chlorine

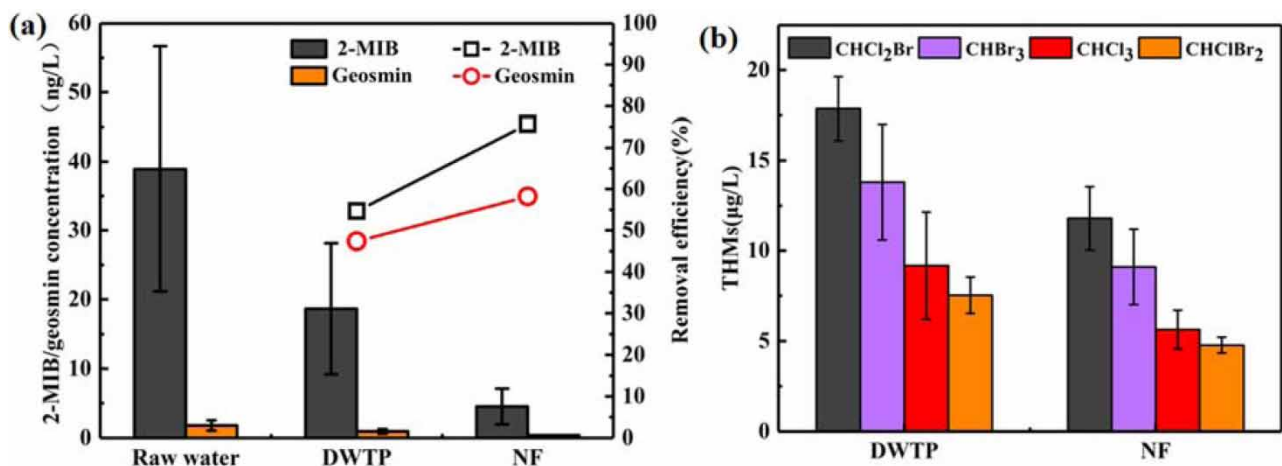

Figure 3 | Variation and removal efficiencies of (a) 2-MIB and geosmin, (b) THMs in each process.

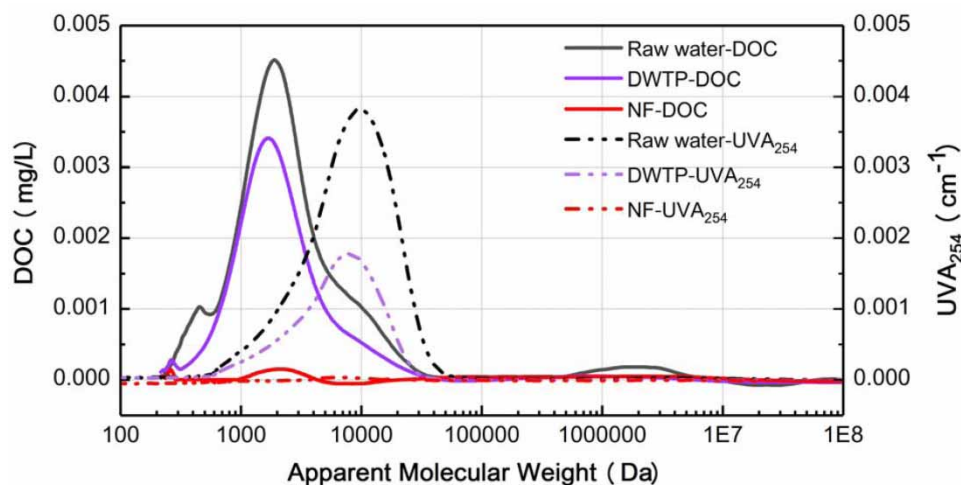

Figure 4 | Representative HPSEC chromatograms highlighting the MW distribution of DOC and UVA₂₅₄ for each sample.

addition. Organic matter components with MWs between 225 Da and 300 Da increased after the DWTP treatment. This phenomenon occurred in both DOC and UVA₂₅₄ detection, and it may be related to the degradation of larger DOC due to chlorination. Nanofiltration membranes exhibited a significant removal effect on organic compounds of all MWs. Larger-molecular-weight organics could be completely retained by the NF membrane, but [Figure 4](#) shows a smaller DOC response peak located at 1,000–1,500 kDa, and the DOC response peak of the feed water is also at this position. A higher solute concentration was present at the membrane surface due to the gradual

increase of the rejected solute near the membrane surface ([Hilal *et al.* 2008](#)).

As shown in [Figure 5](#), the area integration method was used to analyse the changes in different organic matter components according to their MWs. The MW distribution of NOM was fractionated corresponding to the fractions of <1, 1–3, 3–10 and >10 kDa ([Chen *et al.* 2007](#)). Changes in the integrated areas of DOC and UVA₂₅₄ in different MW ranges can indirectly reflect the changes in the concentration of organic matter in the corresponding MW range. The NF process removed 91.20%, 87.66%, 78.41%, 98.99% and 100% of the DOC area

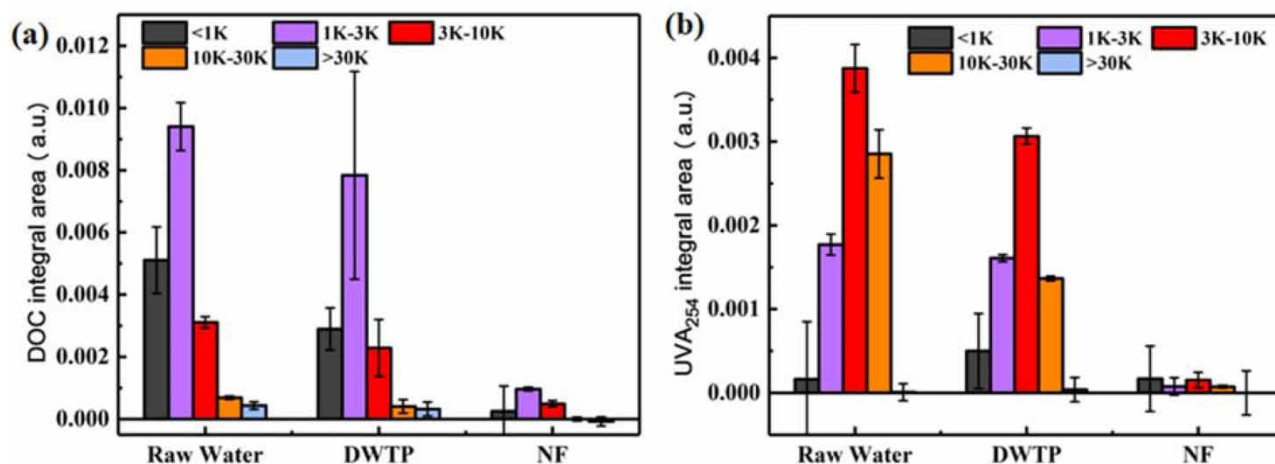

Figure 5 | (a) DOC and (b) UVA₂₅₄ integral areas of different molecular weights.

with fractions of <1, 1–3, 3–10 and >10 kDa, respectively. The corresponding removal rates of the UVA₂₅₄ area for different components were 65.82%, 95.19%, 95.01%, 94.59% and 100%, respectively. The removal effect of UVA₂₅₄ with MW <1,000 Da was much lower than those of the other four components. The removal rate increased with the increase in MW. For substances with MWs larger than the MW cut-off of the membrane, the removal mechanism of the NF membrane is mainly interception screening; however, many studies have shown that the NF membrane still has a good removal effect on organic substances smaller than its pore size. This is mainly because the surfaces of most NF membranes are negatively charged. Donnan and dielectric effects can also effectively ensure the removal of ions and partially charged small-molecular-weight organic matter.

Changes in PARAFAC fluorescence components

PARAFAC analysis (with two to seven components) was performed on the total 62 water samples. However, only three, four and five components could be validated by the split-half method. Tucker's congruence coefficients were applied to check the similarity of excitation and emission

loadings. Tucker's congruence coefficient greater than 0.95 indicates that the factors can be considered to be equal, and only the four-component model could be validated in this research. Figure 6 and Table 3 show the four-component PARAFAC model and the positions of the spectral characteristics of the 62 EEMs in this study. Component 1 (C1) showed two excitation maximums at 206 and 276 nm with a single emission maximum at 320 nm and was thus identified as tryptophan-like substances. Component 2 (C2) can be regarded as amino acids (Ex = 228, Em = 344). Component 3 (C3) belongs to terrestrial/anthropogenic humic substances (Ex = 252, Em = 450), and component 4 (C4) had a protein-like structure and was similar to tyrosine-like substances (Ex = 200, Em = 298). After validation of the four-component model, the fate of the components across the pilot study was tracked using their maximum fluorescence intensities (F_{\max}).

To analyse the effect of water treatment on the fluorescence characteristics of NOM, the mean percentage reductions of F_{\max} across the DWTP and NF treatment processes (Figure 7) were computed. For the raw water samples, mean F_{\max} was 1.36, 1.04, 0.30 and 0.62 RU for C1, C2, C3 and C4, respectively. The result indicates that the samples were dominated by tryptophan-like fluorescent compounds.

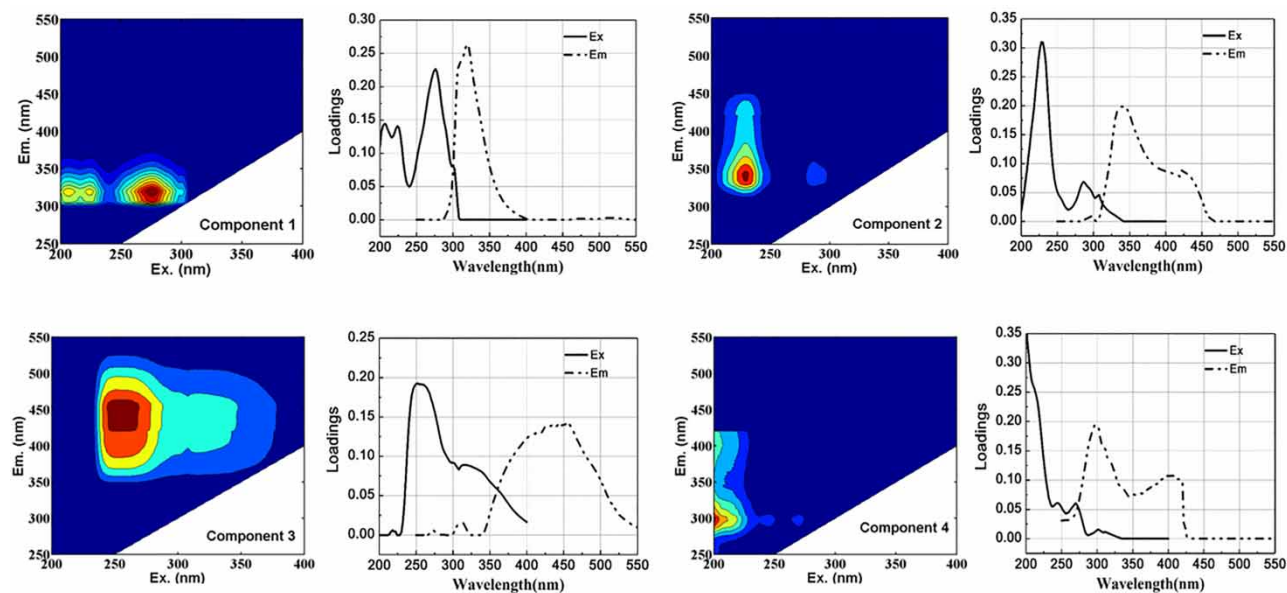
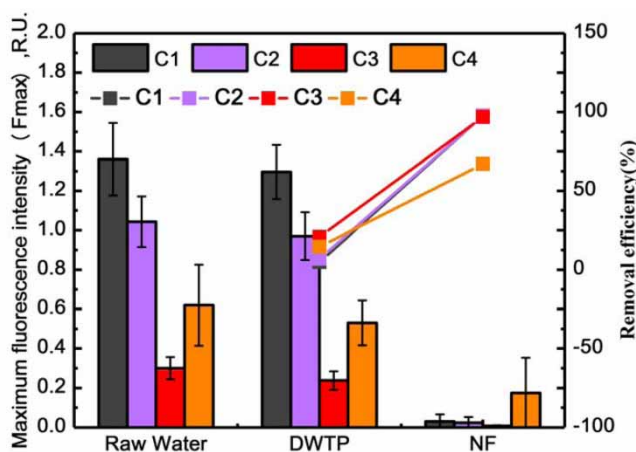

Figure 6 | EEM contours of the four fluorescent components and loadings (C1: Ex206, 276/Em320 nm; C2: Ex228/Em344 nm; C3: Ex252/Em450 nm and C4: Ex200/Em298 nm) identified by PARAFAC analysis.

Table 3 | Spectral characteristics of the four components identified by PARAFAC analysis

Component	Ex	Em	Description and probable source
Component 1	206, 276	320	tryptophan-like substances (Stedmon & Markager 2005)
Component 2	228	344	amino acids (Baghoth et al. 2011)
Component 3	252	450	terrestrial/anthropogenic humic substances (Murphy et al. 2006)
Component 4	200	298	tyrosine-like substances (Xu et al. 2013)

**Figure 7** | Maximum fluorescence intensities (F_{\max}) of PARAFAC components across drinking water plant treatment train and NF process.

The DWTP exhibited a very weak removal effect on the fluorescent organic compounds of components C1, C2, C3 and C4; the removal rates were 4.78%, 6.96%, 20.63% and 14.52%, respectively, while the corresponding removal efficiencies of the NF process reached 97.66%, 97.55%,

96.89% and 66.97%, respectively. Compared with the DWTP process, the NF process showed a significant effect on the removal of fluorescent organic matter in drinking water. The mean percentage reduction of fluorescence is comparable to that of DOC in the case of the conventional treatment (~5–20% for fluorescence and ~17% for DOC). The NF process could almost completely remove components C1, C2 and C3 and was only ineffective in removing component C4. Humic acid and fulvic acid organic matter have higher MW and firmer structure and are difficult for microorganisms to decompose (Allpike et al. 2005); therefore, they could be effectively removed. However, component C4 was mainly a tyrosine-like substance. Studies have shown that these substances are positively correlated with the content of active dissolved organic matter (DOM) components. Free-form amino acids have small MWs and can be rapidly utilized by heterotrophic microorganisms (Cory & Kaplan 2012); therefore, component C4 was not easily retained by the NF membrane.

Correlations

All water samples were included in the determination of Spearman's correlation coefficients. Table 4 presents a correlation matrix obtained with SPSS statistical software. Significant correlation ($p < 0.01$) exists between the DOC concentration and F_{\max} of three PARAFAC components (C1, C2 and C3) as well as between UVA_{254} and F_{\max} . This is because the removal rate of the C4 component by the NF process was not as high as those of the other three components. The removal rates of DOC, UVA_{254} , C1, C2

Table 4 | Correlation matrix of DOC, UVA_{254} , SUVA and fluorescence F_{\max} with the four PARAFAC components for all samples from the DWTP and NF process

	DOC	UVA_{254}	SUVA	C1	C2	C3	C4
DOC	1	0.976**	0.649*	0.935**	0.939**	0.935**	0.681
UVA_{254}		1	0.571*	0.961**	0.968**	0.948**	0.667*
SUVA			1	0.594*	0.594*	0.576*	0.447
C1				1	0.981*	0.925**	0.764
C2					1	0.965**	0.731*
C3						1	0.694*
C4							1

*At level 0.05 (two-tailed), the correlation is significant. **At level 0.01 (two-tailed), the correlation is significant.

and C3 by the NF process were 95.90%, 92.06%, 97.66%, 97.55% and 96.89%, respectively, while the removal rate of component C4 was only 66.97%. Moreover, SUVA had poor correlations with DOC, UVA_{254} and F_{max} of C1, C2, C3 and C4. This result is expected since the water treatment process presented similar removal rates of UVA_{254} and DOC. Thus, the SUVA value was not significantly changed. From the correlation analysis, it can be seen that three-dimensional fluorescence can not only characterize the changes in the organic matter concentration but also monitor abnormal components that cannot be effectively removed from the water. The higher predictive ability of F_{max} allows its use as an alternative to UVA_{254} and DOC for online monitoring of DOM concentration in DWTPs. Furthermore, the higher sensitivity of fluorescence measurements provides more reliable information for water quality analysis during the treatment and distribution of drinking water.

CONCLUSIONS

Pilot-plant studies were carried out to evaluate water quality improvement by NF, and the following conclusions can be drawn.

1. The NF membrane could effectively improve the drinking water quality; the NF treatment further removed both odour substances and THMs.
2. Organic matter components with MWs between 225 and 300 Da increased after the DWTP treatment; the NF process could remove parts of the NOM with MWs less than 200 Da. Nanofiltration exhibited a significant removal effect on organic matter components of all MWs.
3. Four fluorescent components (C1, C2, C3 and C4) were identified in all the samples by EEM-PARAFAC analysis. Compared with the DWTP process, components C1, C2 and C3 were significantly removed by the NF membrane, but component C4 reached the permeate water. Further analysis including HPSEC showed that component C4 seemed to be related to organic matter with MW between 1,000 and 1,500 Da in the membrane water.
4. The indicators DOC and UVA_{254} showed significant correlations with components C1, C2 and C3 but were less correlated with component C4.
5. Further research on the detailed characteristics of NOM in permeate water is needed, and a direct relationship between the fluorescence component and the real concentration of DOM needs to be established.

ACKNOWLEDGEMENTS

This work was supported by the International Science and Technology Cooperation Program of China (2016YFE0123700), the Major Science and Technology Program for Water Pollution Control and Treatment (2017ZX07201001), the Natural Science Foundation of China (No. 51708130), College of Environmental Science and Engineering, Tongji University, Shanghai 200092, China and School of the Environment and Municipal Administration, Lanzhou Jiaotong University, Lanzhou 730070, China. Special thanks to my supervisor, Professor YanChen.

DATA AVAILABILITY STATEMENT

Due to the cooperation between this research project and the water treatment plant, data disclosure needs to be negotiated with other units. If the cooperation units all agree to the publication of the paper data, we will submit it as soon as possible.

REFERENCES

- Ahsan, A. & Imteaz, M. 2019 [Nanofiltration membrane technology providing quality drinking water](#). In: *Nanotechnology in Water and Wastewater Treatment* (A. Ahsan & A. F. Ismail, eds), Elsevier, Amsterdam, The Netherlands, pp. 291–295.
- Allpike, B. P., Heitz, A., Joll, C. A., Kagi, R. I., Abbt-Braun, G., Frimmel, F. H., Brinkmann, T., Her, N. & Amy, G. 2005 [Size exclusion chromatography to characterize DOC removal in drinking water treatment](#). *Environmental Science & Technology* **39** (7), 2334–2342.
- Amy, G., Kim, T.-U., Yoon, J., Bellona, C., Drewes, J., Pellegrino, J. & Heberer, T. 2005 [Removal of micropollutants by NF/RO membranes](#). *Water Science and Technology: Water Supply* **5** (5), 25–33.
- Baghoth, S. A., Sharma, S. K. & Amy, G. L. 2011 [Tracking natural organic matter \(NOM\) in a drinking water treatment plant](#)

- using fluorescence excitation–emission matrices and PARAFAC. *Water Research* **45** (2), 797–809.
- Bruce, D., Westerhoff, P. & Brawley-Chesworth, A. 2002 Removal of 2-methylisoborneol and geosmin in surface water treatment plants in Arizona. *Journal of Water Supply: Research and Technology – AQUA* **51** (4), 183–198.
- Chen, Y., Dong, B. Z., Gao, N. Y. & Fan, J. C. 2007 Effect of coagulation pretreatment on fouling of an ultrafiltration membrane. *Desalination* **204** (1–3), 181–188.
- Chen, H. W., Liang, C. H., Wu, Z. M., Chang, E. E., Lin, T. F., Chiang, P. C. & Wang, G. S. 2013 Occurrence and assessment of treatment efficiency of nonylphenol, octylphenol and bisphenol-A in drinking water in Taiwan. *Science of the Total Environment* **449**, 20–28.
- Chen, S., Dong, B., Gao, K. & Li, T. 2019 Pilot study on advanced treatment of geosmin and 2-MIB with O₃/GAC. *Water Supply* **19** (4), 1253–1263.
- Cheng, S., Oatley, D. L., Williams, P. M. & Wright, C. J. 2012 Characterisation and application of a novel positively charged nanofiltration membrane for the treatment of textile industry wastewaters. *Water Research* **46** (1), 33–42.
- Chon, K. & Cho, J. 2016 Fouling behavior of dissolved organic matter in nanofiltration membranes from a pilot-scale drinking water treatment plant: an autopsy study. *Chemical Engineering Journal* **295**, 268–277.
- Cory, R. M. & Kaplan, L. A. 2012 Biological lability of streamwater fluorescent dissolved organic matter. *Limnology and Oceanography* **57** (5), 1347–1360.
- Doederer, K., Farré, M. J., Pidou, M., Weinberg, H. S. & Gernjak, W. 2014 Rejection of disinfection by-products by RO and NF membranes: influence of solute properties and operational parameters. *Journal of Membrane Science* **467**, 195–205.
- Dubowski, Y., Greenberg-Eitan, R. & Rebhun, M. 2018 Removal of trihalomethane precursors by nanofiltration in low-SUVA drinking water. *Water* **10** (10), 1370.
- Faruqi, A., Henderson, M., Henderson, R. K., Stuetz, R., Gladman, B., McDowall, B. & Zamyadi, A. 2018 Removal of algal taste and odour compounds by granular and biological activated carbon in full-scale water treatment plants. *Water Science and Technology: Water Supply* **18** (5), 1531–1544.
- Gonzalez, B., Heijman, S. G. J., Rietveld, L. C. & van Halem, D. 2019 Arsenic removal from geothermal influenced groundwater with low pressure NF pilot plant for drinking water production in Nicaraguan rural communities. *Science of the Total Environment* **667**, 297–305.
- Gupta, V. K. & Ali, I. 2013 Water treatment by membrane filtration techniques. In: *Environmental Water* (V. K. Gupta & I. Ali), Elsevier, Amsterdam, The Netherlands, pp. 135–154.
- Hilal, N., Al-Abri, M., Al-Hinai, H. & Abu-Arabi, M. 2008 Characterization and retention of NF membranes using PEG, HS and polyelectrolytes. *Desalination* **221** (1–3), 284–293.
- Kim, Y., Lee, Y., Gee, C. S. & Choi, E. 1997 Treatment of taste and odor causing substances in drinking water. *Water Science and Technology* **35** (8), 29–36.
- Liao, X. B., Zhang, X. J., Wang, J., Li, X. B., Wang, C. K. & Chen, C. 2013 Application of conventional and O₃-BAC processes to treat organic matter and antibiotic pollutants in a lake in East China. *Water Science and Technology: Water Supply* **13** (6), 1470–1477.
- Liao, X. B., Cheng, Y. S., Liu, Z. H., Shen, L. L., Zhao, L., Chen, C., Li, F. & Zhang, X. J. 2019 Performance of BAC for DBPs precursors' removal for one year with micro-polluted lake water in East-China. *Environmental Technology*, <https://doi.org/10.1080/09593330.2019.1615132>.
- Lu, S., Shao, Z., Zhong, G., Chen, J., Yang, J. & Guo, J. 2011 BAC filtration–disinfection–sand filtration combination technology for handling risk of microorganism leak in O₃-BAC process. In: *2011 International Conference on Multimedia Technology*, IEEE, Piscataway, NJ, USA, pp. 3870–3875.
- Mo, W. Y., Chen, Z., Leung, H. M. & Leung, A. O. W. 2017 Application of veterinary antibiotics in China's aquaculture industry and their potential human health risks. *Environmental Science and Pollution Research* **24** (10), 8978–8989.
- Murphy, K. R., Ruiz, G. M., Dunsmuir, W. T. M. & Waite, T. D. 2006 Optimized parameters for fluorescence-based verification of ballast water exchange by ships. *Environmental Science & Technology* **40** (7), 2357–2362.
- Murphy, K. R., Stedmon, C. A., Waite, T. D. & Ruiz, G. M. 2008 Distinguishing between terrestrial and autochthonous organic matter sources in marine environments using fluorescence spectroscopy. *Marine Chemistry* **108** (1–2), 40–58.
- Murphy, K. R., Stedmon, C. A., Graeber, D. & Bro, R. 2013 Fluorescence spectroscopy and multi-way techniques. *PARAFAC. Analytical Methods* **5** (23), 6557–6566.
- Nazir, M. & Khan, F. I. 2006 Human health risk modeling for various exposure routes of trihalomethanes (THMs) in potable water supply. *Environmental Modelling & Software* **21** (10), 1416–1429.
- Snyder, S. A. 2008 Occurrence, treatment, and toxicological relevance of EDCs and pharmaceuticals in water. *Ozone: Science & Engineering* **30** (1), 65–69.
- Song, Y., Dong, B., Gao, N. & Xia, S. 2010 Huangpu River water treatment by microfiltration with ozone pretreatment. *Desalination* **250** (1), 71–75.
- Srinivasan, R. & Sorial, G. A. 2011 Treatment of taste and odor causing compounds 2-methyl isoborneol and geosmin in drinking water: a critical review. *Journal of Environmental Sciences* **23** (1), 1–13.
- Stedmon, C. A. & Markager, S. 2005 Resolving the variability in dissolved organic matter fluorescence in a temperate estuary and its catchment using PARAFAC analysis. *Limnology and Oceanography* **50** (2), 686–697.
- Vatankhah, H., Murray, C. C., Brannum, J. W., Vanneste, J. & Bellona, C. 2018 Effect of pre-ozonation on nanofiltration membrane fouling during water reuse applications. *Separation and Purification Technology* **205**, 203–211.
- Waniek, A., Bodzek, M. & Konieczny, K. 2002 Trihalomethane removal from water using membrane processes. *Polish Journal of Environmental Studies* **11** (2), 171–178.

- Xu, H., Cai, H., Yu, G. & Jiang, H. 2013 Insights into extracellular polymeric substances of cyanobacterium *Microcystis aeruginosa* using fractionation procedure and parallel factor analysis. *Water Research* **47** (6), 2005–2014.
- Yang, H. W., Liu, W. J., Wang, X. M., Sun, L. L. & Xie, Y. F. 2015 Bromate control by dosing hydrogen peroxide and ammonia during ozonation of the Yellow River water. *Ozone: Science & Engineering* **37** (2), 127–133.
- Yüksel, S., Kabay, N. & Yüksel, M. 2013 Removal of bisphenol A (BPA) from water by various nanofiltration (NF) and reverse osmosis (RO) membranes. *Journal of Hazardous Materials* **263**, 307–310.
- Zheng, J., Lin, T., Chen, W., Tao, H., Tan, Y. & Ma, B. 2018 Removal of precursors of typical nitrogenous disinfection byproducts in ozonation integrated with biological activated carbon (O₃/BAC). *Chemosphere* **209**, 68–77.

First received 24 December 2019; accepted in revised form 27 April 2020. Available online 20 May 2020