

Monitoring of pollution factors of solidified body leachate in a drilling well site and its influence on the surface water environment

Zhikun Liu, Chaoqun Zhang and Qi Li

ABSTRACT

Aiming at the pollution of the leaching solution of the solidified body in the wellbore, a water eutrophication level evaluation algorithm based on the optimized analytic hierarchy process is proposed from the current situation of many factors affecting the eutrophication of the water body and the difficulty of evaluation. Based on this, the user-oriented PC software monitoring system was developed, which mainly includes three major modules: surface water environment monitoring, water eutrophication evaluation, water bloom prediction and warning, and system assistance. The surface water environment monitoring module can receive and display the surface water environment parameter information in real time, and has the functions of data comparison analysis and historical data search, and the eutrophication assessment and water bloom prediction and warning module can analyze the eutrophication status of water bodies in real time and provide short-term and medium-term warnings for water blooms. This research can promote the control of the leachate pollution of the wellbore in the wellbore and the optimization of the surface water environment.

Key words | drilling, pollution factor, surface water environment, well site solidified body

Zhikun Liu (corresponding author)

Chaoqun Zhang

Qi Li

Engineering Research Center of Development and Management for Low to Extra-Low Permeability Oil & Gas Reservoirs in West China, Ministry of Education, Shannxi Xi'an 710065, China

and

Institute of Petroleum Engineering, Xi'an Shiyou University, Shannxi Xi'an 710065, China

E-mail: gm201803@126.com

HIGHLIGHTS

- Propose a water eutrophication level evaluation algorithm.
- Develop a user-oriented PC software monitoring system.
- The research can promote the control of the leachate pollution of the wellbore in the wellbore.
- The research can promote the optimization of the surface water environment.
- The water bloom prediction and warning module can analyze the eutrophication status of water bodies in real time.

INTRODUCTION

In recent years, the problem of contamination of the solidified body leachate in surface water environment drilling wells, especially the eutrophication of water bodies, has seriously affected or even threatened industrial and agricultural production and people's lives. Drilling well field

solidified body leaching solutions will cause huge pollution of the well site by solidified body leaching of solution in the surface water environment, and monitoring the contamination of the well body solidified body leaching liquid is very important (Wang *et al.* 2017). Compared with the general surface water pollution, the solidified exudate has the characteristics of high salinity, heavy metal content and chemical additives. In surface water pollution monitoring, it is necessary to pay attention to the real-time changes of water salinity,

This is an Open Access article distributed under the terms of the Creative Commons Attribution Licence (CC BY 4.0), which permits copying, adaptation and redistribution, provided the original work is properly cited (<http://creativecommons.org/licenses/by/4.0/>).

doi: 10.2166/ws.2020.356

organic matter and other indicators. Therefore, a buoy-type multifunctional surface water environment monitoring system was designed and implemented, and by monitoring the surface water environment information of rivers and lakes, at the same time, the evaluation of water eutrophication and the prediction of water blooms are of great significance to the protection and treatment of the surface water environment (Furukawa *et al.* 2017).

Based on the overall structural framework of the buoy-type multifunctional surface water environment monitoring system, the hardware and software parts of the system have been designed in detail (Kusaiynov *et al.* 2017). In terms of hardware design, the rigid float ball is used as the main body, and the sensing device such as the main controller, water quality sensor, small weather station, and pan/tilt network camera is equipped to obtain water quality parameter information, meteorological parameter information and water surface real-time image (Liu *et al.* 2017). The ARM (Advanced RISC Machines) processor is a low-power microprocessor designed by Acorn Ltd. Among them, based on ARM embedded technology development, the main controller of monitoring, integrating information collection, processing and remote transmission is the focus of hardware design (Sazonov & Mokhov 2017). The program for the main controller in C language, and is a large control system integrating the water quality data collection and processing system, the meteorological data collection and processing system, the GPS (Global Positioning System) geographic information collection and processing system, the SMS alarm sending system and the ARM control system, and it has the characteristics of being able to quickly process a large amount of surface water environment monitoring data, and quickly analyze and process data and transmit data, which is innovative (Li *et al.* 2017). The research is divided into three parts. The first part is the literature review. The second part is the hardware and software development of the pollution factor monitoring of the solidified body leaching solution in the well site, and the software and hardware design. The third part is testing of the system and the proposed method verification.

RELATED WORK

According to Keller and colleagues, there are currently three methods commonly used in water quality information

monitoring methods in China: the first is that people collect water samples and then go to the laboratory for analysis, but the monitoring process is cumbersome, and the cycle from the initial collection of water samples to the results is too long (Keller *et al.* 2017). The second is a large-scale fixed water quality automatic monitoring station, Alam and colleagues proposed, its large size, difficult to move, high cost of construction and maintenance (Alam *et al.* 2018). The third is to use a conventional ship to monitor the water body using a portable instrument for the carrier. Xia and colleagues applied it, who and believes that the water quality information obtained is too simple and cannot be transmitted online (Xia *et al.* 2018). Alves and colleagues believe that these three types of monitoring methods have their own shortcomings, and it is impossible to monitor the waters in real time, dynamically and extensively, and it is not effective to carry out water eutrophication evaluation and water bloom prediction and warning (Alves *et al.* 2018). Therefore, Pavlidis & Tsihrintzis applied a buoy-type multi-purpose surface water environment monitoring system for rivers and lakes with large water area, which carries out the real-time dynamic monitoring of water bodies. The monitored surface water environment parameters are transmitted to the upper computer software monitoring system, which can monitor the surface water environment parameter information in real time, which has great ecological and social value for protecting surface water environment resources (Pavlidis & Tsihrintzis 2018). Li and co-workers evaluated the eutrophication of water bodies and believes that because of its many influencing factors, the causes are complex and there is no real standard evaluation method (Li *et al.* 2018) Zhongzhi and colleagues believe that evaluators often only pay attention to the influence of surface water environment parameters and ignore the subjective factors such as expert experience. Therefore, evaluation of water body eutrophication has always been an urgent problem to be solved in surface water environment protection work (Zhongzhi *et al.* 2018). Sobrinho and co-workers used an optimized analytic hierarchy process, as well as the surface water environment information and subjective expert experience of the customer view, assessing the degree of eutrophication of the water body, making the evaluation results convincing, thus providing an effective decision-making basis for relevant departments (Sobrinho

et al. 2018). Although the current research has been rich in the monitoring of surface water environment, there are not many studies on monitoring the pollution factor of the solidified body leachate in the well site and its impact on the surface water environment (Jing 2018). Based on this and the previous research, monitoring of the surface water environment polluted by the solidified body leachate in the well site was studied.

DRILLING WELL FIELD SOLIDIFIED BODY LEACHATE POLLUTION FACTOR MONITORING HARDWARE AND SOFTWARE DEVELOPMENT

The development of the main controller hardware

The main controller of the buoy multifunctional surface water environment monitor is a multifunction master composed of a program burning interface, an Ethernet interface, a serial port interface and the like, which is an ARM architecture, including GPRS (General Packet Radio Service) general packet wireless service module and GPS module. The main controller's CPU (Central Processing Unit) uses a powerful ARM9 series processor with low power consumption, small size and low cost. In addition, compared to the previous series, the ARM9 series selects the Harvard architecture, and its increased pipeline architecture enhances its parallel processing skills; it improved the instruction cycle, which greatly improves the performance of the processor, which can increase performance by about 30%; the main controller developed by this system is shown in Figure 1. In terms of hardware, the main controller mainly includes a central processing unit, a 2-way serial

interface, a GPS module, a memory, and a GPRS general packet wireless service module, multiple output voltage, two analog inputs, Ethernet interface, program programming interface, eight dry contact switch inputs and four dry contact switch outputs. Figure 1 shows the main structure of the main controller.

In the main controller of the buoy system, the central processor is connected to eight circuits to control the working process of all functional modules, including data acquisition, analysis, format integration and transmission. As the core of the entire buoy-type multi-purpose surface water environment monitoring system, the central processor controls other functional modules to complete their respective work. In addition to the central processor, the remaining modules in the controller complete their respective functions at the appropriate time. The ferroelectric memory and the FLASH module complement each other and are used to store water quality data information, weather parameter information, and other information. After the RS232 serial port is connected to the RS232-RS485 function chip, it is connected to each sensor, which is used to obtain water quality information and meteorological information of the monitored water body. The GPS module is used for dynamic positioning in monitoring the buoy system, and collects position information of the buoy at various time points. Using the 3G wireless network router, the water quality parameter information collected by the water quality sensor, the meteorological parameter information collected by the small weather station and the geographical location information collected by the GPS are transmitted to the upper computer software by using the 3G wireless network; the GPRS module is used to push the surface water environment information or alarm SMS to the user's mobile phone through the mobile phone network at an appropriate time. In addition to this, the master also has a watchdog circuit and a reset button. The watchdog circuit is used to protect various hardware devices to work properly. The reset button is related to two reset modes. When the reset button is pressed shortly, the hardware device is reset. When the reset button is pressed, the hardware restores the initial value. The network interface circuit is mainly embodied in the transformer circuit and is mainly used to transmit Ethernet signals. In order to ensure the quality of the network signal, the circuit also has anti-interference

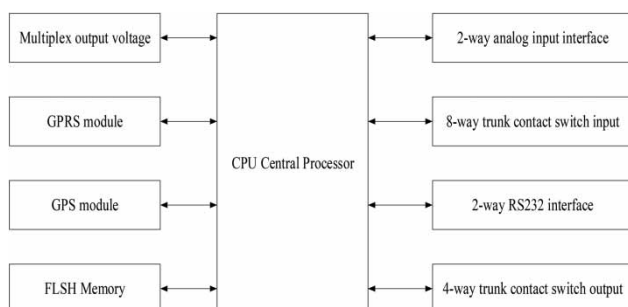

Figure 1 | Main controller structure.

functions such as signal clutter suppression and impedance matching. The network interface pins are shown in Table 1.

Software function development

The lower part of the buoy system selects the fourth generation version of Code Composer Studio as the lower platform for development. The software is slightly different from other software in that it has a single user interface that can be used to complete every step of the R&D design process. As a powerful software tool that can be used in an integrated development environment, it encapsulates a full set of tools for developing and debugging programs, which integrates editing, compiling, debugging, emulation and other functions to provide convenience for users. The software of the lower part of the buoy system applies the modular design idea, and the different functions are built into different subsystems to speed up the overall running speed of the lower computer. At the same time, it also reduces the amount of work required to upgrade software features. The GPRS general packet wireless service module and the GPS module are simultaneously integrated in the main controller, and the collection, analysis, processing and transmission of water quality information parameters, meteorological information parameters and geographical location information parameters are realized by using various interfaces to connect with various sensors (RS232 interface, analog interface, program programming interface, Ethernet interface, etc.); to send surface water environment information to the user's mobile phone and send a dangerous alarm message to the user's mobile phone; and a remote control function. The main controller applied to the buoy-type multifunctional surface water environment monitoring system can collect surface water environment parameter information (water quality information, weather information, geographical location information) in real time, which has the functions of packaging all

Table 1 | Network socket pin table

Pin number/name	Pin number/connected chip
9	6-RX -
11	3-RX +
14	2-TX -
16	1-TX +

kinds of surface water environment data collected by format, then real-time transmission through 3G wireless network, main controller status control function (3G network, temperature), SMS push function and other basic functions. The subordinate machine software part of the buoy system applies the modular design idea to make different functions into different submodules, and the water quality information collection and transmission module, the meteorological information collection and transmission module, the GPS global positioning module, the GPRS/3G wireless network transmission module, and the short message sending module are integrated. The software functional architecture is shown in Figure 2.

The main controller of the buoy-type multifunctional surface water environment monitoring system mainly includes a water quality information acquisition and transmission module, a meteorological information acquisition and transmission module, a GPS module, a wireless network transmission module, and a short message sending module. Among the above modules, the water quality information collection and transmission system module and the meteorological information collection and transmission system module are the cores of the whole software. Due to the role of the timer, according to its own crystal frequency, when the time is up to half an hour, the system will encapsulate the surface water environment data collected by various sensors and GPS into a data packet by parsing the data and arranging the transmitted data format, and finally, the data packet is transmitted to the host computer software monitoring system through the 3G wireless network. The buoy lower machine main program aims to achieve initialization and main body loop. In the main program, the system initialization part includes the central processor,

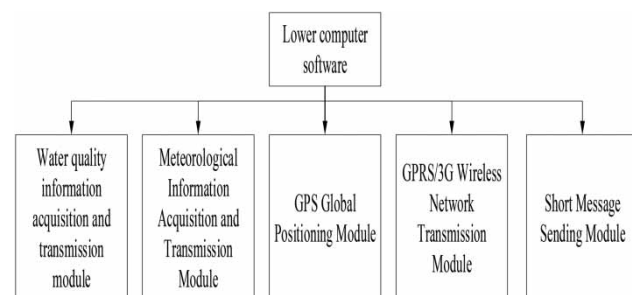

Figure 2 | Software function architecture of lower computer of buoy system master controller.

timer and peripheral chip initialization, as well as parameter configuration in the GPRS module, and obtains the IP address and port number of the upper remote server. The main loop part mainly reads the serial port data expansion around the timing loop. That is, once the number of seconds counted by the timer is reached, the corresponding program is executed. The flow chart of the lower machine main program is shown in Figure 3.

Once the buoy-type multifunctional surface water environment monitor is powered on, the system configuration is first initialized, and the corresponding parameters of the GPRS module are configured in the form of an AT command. After that, it is connected with the address and port number of the upper remote monitoring system, and establishes a TCP transmission control protocol connection with it to prepare for transmitting the surface water environment information to the upper system. After the system initialization process ends, the water quality information, weather information, and geographic location information are collected, processed, and transmitted as the timer expires. In the water quality information collection, processing and transmission module, one of the two RS232 interfaces is used to connect with the water quality sensor, and the water quality information is transmitted to the upper monitoring system by using the 3G wireless network. The flow chart of water quality information collection, processing and transmission module is shown in Figure 4.

When the timing of the timer design arrives, the water quality sensor sends the water quality information collected by the water quality sensor to the main controller, that is,

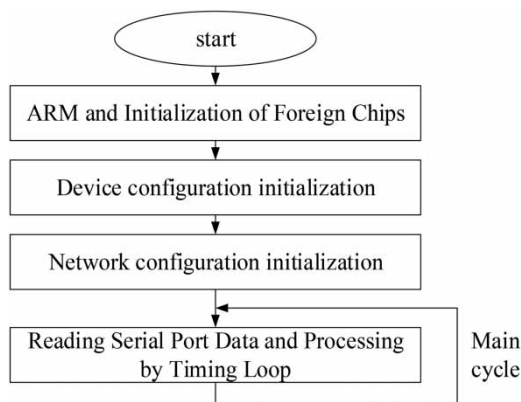

Figure 3 | The main program diagram of the lower computer.

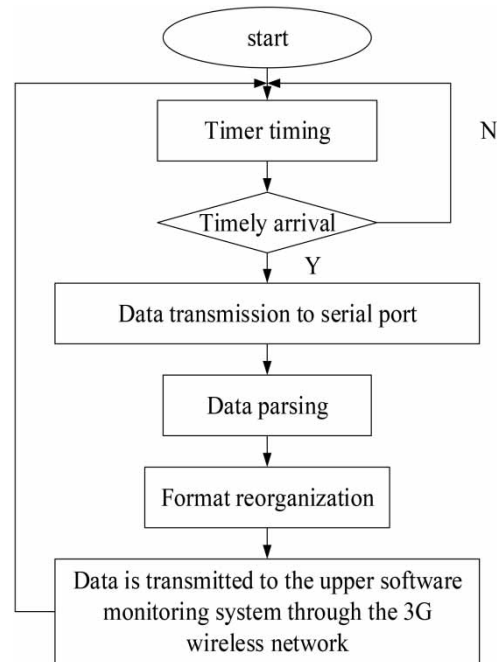

Figure 4 | Flow chart of water quality information collection, processing and transmission module.

the original water quality parameter data. After that, the original data and the recombined data format are parsed in order according to the program in the controller, and the data packet is prepared according to the communication protocol of the upper system. Finally, there is a wait for it to be transmitted to the upper software monitoring system through the 3G wireless network, and complete a cycle, and repeat the process. In this module, another pathway of two RS232 interfaces is connected with a small weather station (wind speed and direction sensor, rain sensor, and illuminance sensor), and the 3G wireless network is used to complete the weather monitoring information sent to the upper monitoring system. The flow chart of the meteorological information acquisition, processing and transmission module is shown in Figure 5.

When the timing of the timer design arrives, the small weather station (wind speed direction sensor, rainfall sensor, illuminance sensor) sends its own collected meteorological information, i.e., the original weather parameter data, to the main controller. After that, the original data and the recombined data format are parsed in order according to the program in the controller, and the data packet is prepared according to the communication protocol of the

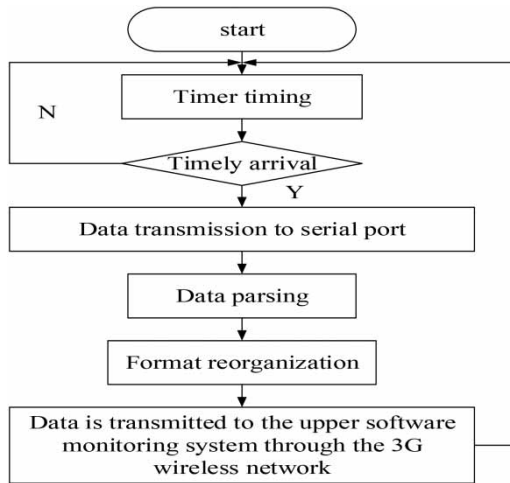

Figure 5 | Flow chart of meteorological information acquisition, processing and transmission module.

upper system. Finally, there is a wait for it to be transmitted to the upper software monitoring system through the 3G wireless network, and complete a cycle, and repeat the process. The GPS module equipped with the GPS receiving circuit and the GPS antenna is integrally packaged into the main controller, and the communication satellite is used to complete the specific positioning of the buoy. The main purpose is to acquire the satellite signal in real time, to accurately track and locate the buoy system, and then determine the geographical location information of the monitoring point, that is, the latitude and longitude coordinates. The work of the short message sending module is mainly completed by means of a GPRS module encapsulated inside the main controller. It is based on the AT command transparent transmission technology, and by inserting a SIM card into the GPRS module, functions such as transmitting information and setting a super user can be completed. The SMS module flow chart is shown in Figure 6.

EXPERIMENTAL DESIGN AND ANALYSIS

Through the software development and hardware design of the main controller, according to the set principle of the upper and lower communication protocols, the computer centralizes control and implementation of the buoy monitoring system. Through the laboratory simulation site, the 3G

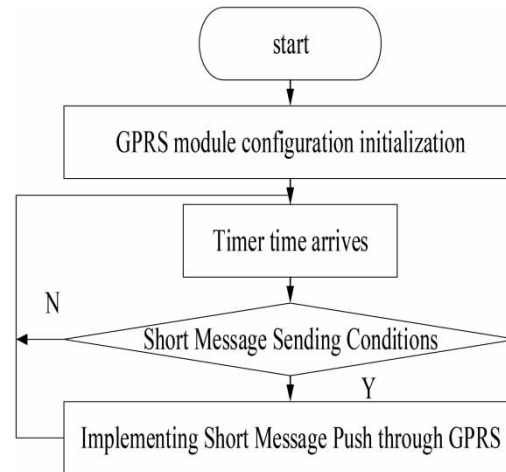

Figure 6 | Short message sending module stream.

wireless router is used to form a wireless network, and the main controller is provided to perform surface water environment information transmission to the upper software monitoring system. Through each laboratory test, any problem is continuously displayed in the results, and then the corresponding point improvement is found in the program, and then tested. This cycle is carried out, until the upper software monitoring system can stably receive the surface water environment monitoring information transmitted to the lower computer. Before the surface water environment data are sent, if the 3G wireless network transmission modules and the upper software monitoring system are successfully connected, the word 'NetOK' is displayed on the serial port debugging assistant, indicating that the network connection is completed, then the lower computer starts to transmit surface water environment data. When the upper software monitoring system receives the data packet and unpacks successfully, it will notify the lower computer by returning a status information, and the lower computer ends the thread. When the upper software monitoring system has not successfully connected to the main controller for a long time, the word 'TimeOut' is displayed on the display serial debugging assistant, indicating that the network connection fails, and the operator is reminded to check the network connection.

VC++ is an object-oriented visual integration programming environment developed by Microsoft. It is widely used because it contains auto-complete and error-removal

features. For example, it allows the user to remotely debug the program and step through, and enables the operator to compile the modified program again when debugging. In this process, it is not necessary to re-open the code for debugging at that time. These advantages greatly reduce the time it takes to edit, compile, and link, and are even more apparent on large system software. Most of the time, applications use the 'socket' to make requests to the network or to respond to network requests. There are three steps of server monitoring, client request and connection confirmation from first to last. When the server listens, the upper server and the lower computer are prepared for the connection, waiting for the connection, and in this process, the state of the network is also monitored. When the client requests, the lower computer SOCKET sends a request to connect to the upper server SOKET. Before this, it needs to know the address and port number of the server. Otherwise, the application cannot be made. When the connection confirmation is confirmed, when the upper server responds to the lower application, it will send the description of its SOCKET to the lower computer through the thread, and the lower digit confirms that the two are connected. After that, the upper server replies to the initial server listening state, waiting for other lower computers to issue an application.

GIS technology. GIS is a tool on a computer that can analyze and process the situation of space. In other words, it transforms all the conditions of the Earth, including all events produced, into the form of a graph and then parses it. GIS technology combines the visual experience of the map and the geographic analysis with the functions of some databases, such as search and management. The user can access the upper software monitoring system to observe the real-time water circulation within the different monitoring ranges of the monitored water body. The acquisition of parameter information in surface water environment monitoring and water bloom prediction software mainly includes that the monitored surface water environmental parameters are visualized and that the water quality information parameters obtained by the water quality sensor and the meteorological information parameters obtained by the small weather station (wind speed and direction sensor, rainfall sensor, and illuminance sensor) are provided, including total salt content, dissolved oxygen

saturation, temperature, chlorophyll, pH, dissolved oxygen, salinity, redox potential, electrical conductivity, blue-green algae, ammonia nitrogen and other water quality indicators; meteorological indicators such as wind speed, wind direction, rainfall, and illumination. After collecting and processing the data uploaded by each sensor, the main controller of the buoy system transmits the surface water environment information collected on the site to the upper computer software monitoring system through the 3G wireless network transmission module, and after using the network to obtain the corresponding parameters, it begins further analysis. The surface water environment information collected by various sensors is stored in the SQLSever database management system through the upper software monitoring system platform, so that the operator can perform operations such as query and report printing. Based on the communication protocol of the buoy system, the upper system adopts the following program design, and the specific implementation flow chart of data reception is shown in Figure 7.

The upper monitoring software system can receive the data packets transmitted by the lower nodes to the upper level, obtain the correct information through verification,

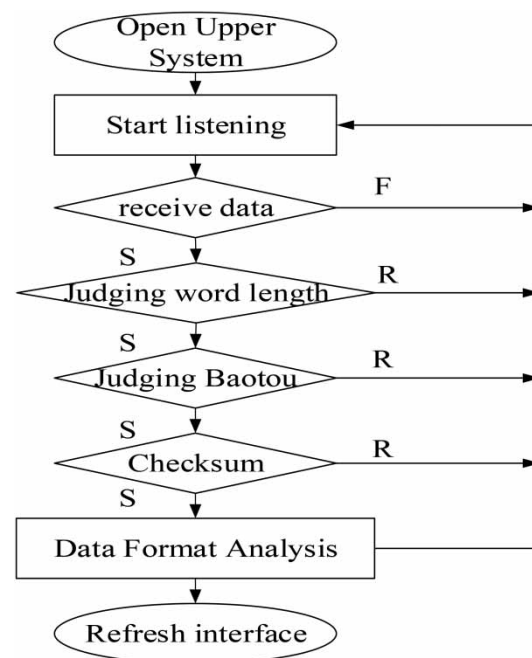

Figure 7 | Data receiving implementation flow chart.

and store the monitoring data in the database. The lower system ensures that the data format is correct, and the on-site water quality information, meteorological information and location can be transmitted to the upper position, and monitored by the upper staff. The upper monitoring software uses the 3G wireless network to receive the surface water environment information sent by the master controller. After that, it analyzes the surface water environment parameters and then starts intelligent integrated management and control, thus completing the functions of real-time information, historical information search, and water eutrophication assessment. In this way, the monitored remote water condition and data analysis processing can be better viewed by the upper remote server. The figure above shows the status of the surface water environment information transmitted by the upper software monitoring system to the lower computer. The data information is displayed in the box below the software interface. If the surface water is polluted by the solidified leaching solution of drilling well site, the organic matter content in the surface water will increase, and the corresponding water quality indexes such as cod will reflect obvious abnormality. In case of surface water pollution, when the pollution exceeds a certain range, water eutrophication will occur. Table 2 shows the monitoring results of surface water environment in the software system. According to the monitoring results in Table 2, there is no surface water pollution problem caused by solidified body leaching solution in the current monitoring sites.

The right side of the software screen shows the real-time connection status of the network. The operator can judge whether the upper software monitors whether the system is connected to the controller by whether the thread is connected or not. Through the linkage test of the upper and lower positions, it confirms that the water quality information, meteorological information and geographical location information in the buoy system are transmitted

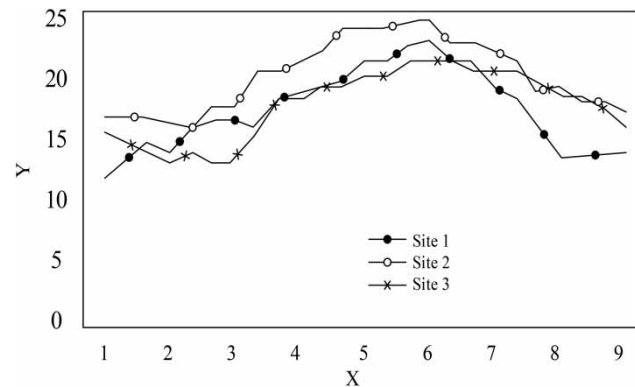

Figure 8 | Data analysis community.

stably, and the functional requirements are realized. The data analysis function is also in the toolbar above the main interface of the software, by determining the start and end dates, specific parameters, and site numbers of the information being queried, the detailed range of changes of the required parameters in the set time period can be displayed in the interface. Furthermore, by selecting the comparison site, the range of changes of the same parameters of different sites in the same time can be observed on the interface, and the monitored water body is comprehensively evaluated, as shown in Figure 8.

CONCLUSION

A buoy-type multifunctional surface water environment monitoring system based on embedded technology is designed, and an optimized analytic hierarchy process is proposed to determine the weighting algorithm for water eutrophication evaluation. The integrated design of the hardware part of the buoy system is completed, including the hierarchical construction of the buoy, the integration of various sensors and instruments, and the design of the main controller. The ARM9 series central processing unit

Table 2 | Statistics of surface water environment monitoring data

Sampling location	pH	Chemical oxygen demand	Ammonia nitrogen	Petroleum	Chloride	Hexavalent chromium
River 170 m to the east of the well pad	7.78	12	0.054	0	37.3	0
Ditch 5 m below cuttings pool	7.84	13	0.063	0	39.3	0
Standard value	6–9	≤20	≤1.0	≤0.05	/	≤0.05

is applied to the main controller, and the collection, processing and transmission functions of the surface water environment information (water quality information, weather information, geographical location information) and the SMS push function are realized according to the preset function requirements. Different from other buoys, the addition of the PTZ network camera enables the buoy to monitor the water surface in real time for 24 hours, and supports functions such as video playback and mobile phone viewing of water surface images. The application of the upper software monitoring system realizes real-time receiving and displaying the surface water environment monitoring information sent by the main controller, historical data query, data comparison analysis and other surface water environment monitoring functions. In addition, the application software can also implement system-assisted functions such as user login, report printing, and network status viewing. The study provides a theoretical reference for the monitoring of the pollution factor of the solidified body leachate in the well site and its impact on the surface water environment. In the next step, the networking mode can be increased, and other networking methods can be tried, such as receiving data using the mobile app, to further improve work efficiency.

DATA AVAILABILITY STATEMENT

All relevant data are included in the paper or its Supplementary Information.

REFERENCES

- Alam, L., Mokhtar, M. & Alam, M. M. 2018 Seasonal variation and preliminary risk assessment of trace element pollution in surface water from Langat River, Malaysia. *Social Science Electronic Publishing* **10** (1), 19–40.
- Alves, D. D., Riegel, R. P. & De, D. Q. 2018 Seasonal assessment and apportionment of surface water pollution using multivariate statistical methods: Sinos River, southern Brazil. *Environmental Monitoring & Assessment* **190** (7), 384.
- Furukawa, Y., Mukai, K. & Ohmura, K. 2017 Improved slant drilling well for in situ remediation of groundwater and soil at contaminated sites. *Environmental Science & Pollution Research* **24** (7), 1–8.
- Jing, Z. 2018 Adaptive PI control of bottom hole pressure during oil well drilling. *IFAC-PapersOnLine* **51** (4), 166–171.
- Keller, D. H., Horwitz, R. J. & Mead, J. V. 2017 Natural gas drilling in the Marcellus Shale region: well pad densities and aquatic communities. *Hydrobiologia* **795** (1), 1–16.
- Kusainyov, K., Nussupbekov, B. R. & Shuyushbayeva, N. N. 2017 On electric-pulse well drilling and breaking of solids. *Technical Physics* **62** (6), 867–870.
- Li, J., Miao, H. & Hui, Z. 2017 Numerical model for evaluating well kick and lost circulation during managed pressure drilling. *Chemistry & Technology of Fuels & Oils* **53** (4), 557–568.
- Li, G. Z., Liu, G. R. & Wei, L. 2018 Analysis and optimization of control algorithms for RSS TSP for horizontal well drilling. *Journal of Petroleum Exploration & Production Technology* **8** (4), 1–10.
- Liu, H., Wang, B. & Zhao, L. 2017 Drilling fluid technology for use in drilling well sy125 in Syl Gas field in country B. *Drilling Fluid & Completion Fluid* **34** (3), 44–48.
- Pavlidis, G. & Tsihrintzis, V. A. 2018 Environmental benefits and control of pollution to surface water and groundwater by agroforestry systems: a review. *Water Resources Management* **32** (1), 1–29.
- Sazonov, Y. A. & Mokhov, M. A. 2017 Development of hybrid equipment for well drilling and hydrocarbon production from offshore deposits. *Chemical & Petroleum Engineering* **53** (10), 1–5.
- Sobrinho, N. M. B. D. A., Ceddia, M. B. & Zonta, E. 2018 Spatial variability and solubility of barium in a petroleum well-drilling waste disposal area. *Environmental Monitoring & Assessment* **190** (4), 228.
- Wang, H., Ge, Y. & Lin, S. 2017 Technologies in deep and ultra-deep well drilling: present status, challenges and future trend in the 13th five-year plan period (2016–2020). *Natural Gas Industry* **4** (5), 319–326.
- Xia, J., Wang, L. & Yu, J. 2018 Impact of environmental factors on water quality at multiple spatial scales and its spatial variation in Huai River Basin, China. *Science China Earth Sciences* **61** (1), 1–11.
- Zhongzhi, H., Zhanghua, L. & Zaiming, W. 2018 Improving the lubricity of extended reach, well. drilling equipment using non-fluorescent extreme pressure cationic lubricants. *Chemistry and Technology of Fuels and Oils* **54** (4), 513–522.

First received 29 July 2020; accepted in revised form 15 November 2020. Available online 7 December 2020