

System for controlled distribution of non-demand-covering water availability: concept, design and modelling

David Walter and Philipp Klingel

ABSTRACT

This paper presents a novel water supply system to distribute limited water resources with varying quantity. The system enables a controlled, planned and, thus, fair distribution of the water availability independently from the consumption patterns. The system input is transported by gravitation through a branched pipe system to decentralised storage tanks. Each storage tank is allocated to a supply unit which comprises several consumers and, possibly, distribution structures connecting the consumers and the tank. At every junction the water is divided by a distribution tank with several chambers that are separated by weir overflows. Water that is not consumed is redistributed in the system automatically. The concept, the components, planning criteria and system design as well as the system modelling are described within the paper. The application of the solution in a supply area located in northern Vietnam is outlined.

Key words | appropriate technology, controlled division, equality, water distribution, water scarcity, water supply

David Walter (corresponding author)
Water Supply Consultant,
Rudolfstr. 8,
76131 Karlsruhe,
Germany
E-mail: david-walter@gmx.de

Philipp Klingel
Stadtwerke Karlsruhe Netzservice GmbH,
Daxlander Str. 72,
76127 Karlsruhe,
Germany

HIGHLIGHTS

- The hydraulically self-acting system enables a fair distribution during non-demand-covering operation and a conventional distribution during demand-covering operation.
- The low-maintenance components and the minimal effort required for operation and control supports an application where know-how and funding is limited.
- System design and system modelling are based on intelligible approaches and open-source software.

GRAPHICAL ABSTRACT

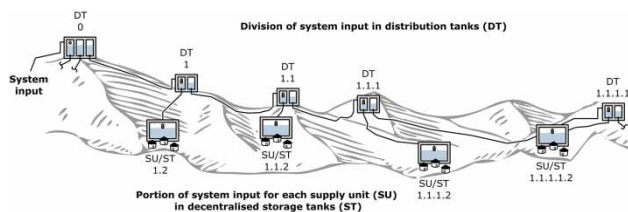

This is an Open Access article distributed under the terms of the Creative Commons Attribution Licence (CC BY 4.0), which permits copying, adaptation and redistribution, provided the original work is properly cited (<http://creativecommons.org/licenses/by/4.0/>).

doi: 10.2166/ws.2021.028

INTRODUCTION

While in industrialised countries the water supply in rural areas is realised largely via piped water supply systems, the connection rate in developing and emerging countries is only 28% (UNIFEC & WHO 2015). The portion of the population that is not connected to a water supply system has to be supplied through alternative, mostly individually implemented concepts. This could be the collection of spring or surface water, the harvesting of rainwater or the purchase of commercial drinking water. For this purpose, private installations are also used, such as cisterns, hoses or pipes (Zelenika 1991; Sutton 2004; Mara & Evans 2011).

Such alternative supplies are associated with significant difficulties for the consumers, among others, to overcome the distance to the nearest resource, and with comparatively high costs, e.g. for private installations, the purchase of water or the loss of earnings in times of collection. A heterogeneous spatial distribution and a temporal variability of the resources lead to uncertainties for consumers and, above all, inequality in terms of access, quantity and quality. The more distinct the water scarcity in a region, the more severe the deficits and inequality of the supply situation (Aleixo *et al.* 2016; Ohwo 2019).

In case of greater distances between the available water resources and the consumers, a central system for transporting the water from the resource to the supply areas can be expedient in improving the supply situation. It is known that the implementation of a central water distribution, as it is largely realised in industrialised countries and in which the system is continuously filled with water and operated under pressure, requires high standards of knowledge in construction, operation and maintenance as well as in organisation and management. According to the system concept for continuous supply, the water demand must be met at all times. If these requirements are not met, the water distribution system will sooner or later be operated intermittently. Water is fed into the distribution system only for limited time periods. Hence, water is only available for consumption during these periods, and private storage is necessary. In addition, the system hydraulics do not allow an equal distribution of the available water. The condition of the supply infrastructure is constantly deteriorating and

water losses are gradually increasing. The fed-in water quality cannot be maintained, the water has to be boiled and additional drinking water has to be purchased. Finally, consumers are supplied with different water quantities and qualities (Klingel 2012; Ameyaw Memon & Bicik 2013; Klingel & Nestmann 2014; Kumpel & Nelson 2016; Simukonda Farmani & Butler 2018).

This article presents a technical solution with the primary purpose of distributing limited and fluctuating water availability in a planned and controlled manner within a supply area. In this way, a fair distribution of non-demand-covering water quantities can be realised (e.g. a distribution proportional to the population). The requirements to the solution are low-maintenance components and low efforts for operation and control. The central element of the solution is a so-called distribution tank (DT), which consists of several chambers. The water flowing into a chamber of the DT is divided into further chambers via weir overflows with variable widths, to which lower lying DT are connected via pipes. Thus, the system input flows by means of gravity through a branched pipe network, in which a DT is arranged at each junction, to the consumers' storage tanks (ST) at the end of the network branches. If the available water at a ST is not totally withdrawn, a float valve closes the ST and thus the system branch. The water flows through the next higher DT into the parallel branch. If there is no consumption in this branch either, then the water flows through the next higher DT into the parallel branch. Regardless of the inflow, the fed-in water can be divided in a predetermined ratio by adjusting the weir widths. If the demand exceeds the availability or if the availability is (temporarily) zero, the system or individual branches can run empty.

The basic principle of dividing water by weir overflows is well known. For example, in the first century BC, the Roman engineer Vitruvius described a solution for dividing the water flowing into a city with several basins that are connected by pipes (Perrault 1684; Callebat 1973). Similar systems for dividing water were actually implemented in the Roman Empire, e.g. in Pompeii, in Thuburbo Minus in today's Tunisia and in Nemausus, today's Nîmes in France (de Montauzan 1908; Stübinger 1909; Kretschmer

1983; Ohlig 2004). The approach was also used later, e.g. in the medieval city of Heidelberg in Germany (Walter 2020). Nowadays, this drinking water or raw water supply principle is no longer applied. Applications can only be found in open channel systems for irrigation (van den Bosch et al. 1993).

This paper focuses on the explanation of the concept and the components of the solution as well as the system design and modelling. The implementation of the system in a supply area in northern Vietnam is briefly described.

CONCEPT AND COMPONENTS

The task of a DT is to divide and forward water within the distribution system. A DT consists of a pre-chamber (PC) and several sub-chambers (SCs). Inflowing water first reaches the PC and is then divided into the SCs. Via pipes connected to the SC, the resulting partial flows are forwarded to the next lower lying DT or storage tanks (STs) of the consumers.

The division of the water is archived by weir overflows, which are arranged between the PC and the SCs. The weir overflows must allow an adjustment of the weir widths. The ratio of the weir widths to each other defines which proportion of the inflow reaches the respective SC. The adjustment of the weir widths should be flexible so that the division can be adjusted during operation in order to consider long-term or short-term changes in water demand.

With exception of the highest lying central DT, which is located at the beginning of a distribution system, all DTs and all STs are equipped with float valves. Float valves allow the inflow to be throttled during demand-covering operation. If there is no demand, the flow is interrupted. Excess water is backed up and redistributed throughout the system via the higher lying DT. Hence there are three possible operating scenarios for a DT.

Figure 1 illustrates these operating scenarios with an exemplary DT that divides the inflow into three SCs. In the example, the weir widths are selected according to the consumers connected to each SC in order to achieve a fair distribution. In scenario 1 there is no coverage of the water

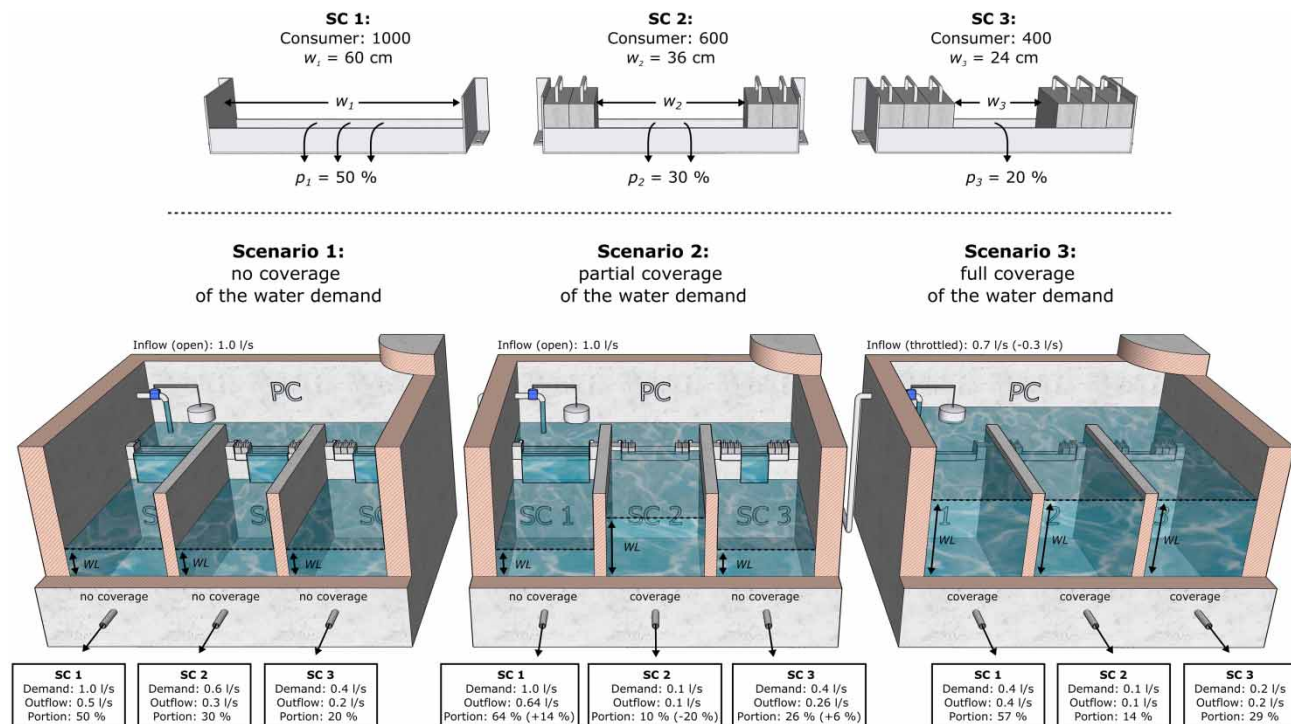

Figure 1 | Functionality of a DT comprising three SCs (p : percentage of inflow, PC: pre-chamber, SC: sub-chamber, ST: storage tank, w : weir width, WL : water level).

demand. The water flows from the SC directly to the consumers and the division is based on the set weir widths. During a non-demand-covering operation, the inflow is distributed in a controlled manner. In scenario 2, the water demand is partially covered. Since the inflow in SC 2 exceeds the demand, water is backed up and SC 2 fills up to the water level of the PC. The excess water is now redistributed proportionally to the remaining SCs according to the weir widths. With an excess amount of 20% from SC 2, 14% flows into SC 1 and 6% into SC 3. During a partial-demand-covering operation, excess water is also proportionally divided and redistributed in the system. In scenario 3, the demand is fully met. The outflow from the SC is in line with demand. The excess water backs up in all SCs and impounds the weir overflows, which lose their function. The flow into the DT is now throttled by the float valve. During a demand-covering operation, the DT behaves like a filled flow tank.

The system concept is based on a decentralised water storage near the consumers and a branched feeder system with DTs. The system input takes place at the highest lying, central DT. Here the water is divided for the first time and forwarded to lower lying DTs and STs. Further system inputs into lower-lying DTs from additional resources are possible as well. Each system branch ends in the ST of a so-called supply unit (SU), which comprises

several consumers. Between the ST and the consumers of an SU, different distribution structures can be implemented. A typical example of this would be a village with a shared village tank. The decentralised water storage creates a hydraulic separation that only allows the consumers to withdraw the water allocated to their SU.

The system concept is shown schematically in Figure 2. The notation of the SUs and the system elements results from their position in the distribution system and from the associated supply path. The division within the DT is determined as percentages p_n . Each percentage refers to the weir overflow of an SC, whereby all percentages are considered relative to each other within a DT. Thus, the absolute share of an SU is the product of all relative percentages within the supply path.

DESIGN

Pipe system

Since the distribution system is supposed to allow a demand-covering operation when there is sufficient water available, the pipe system is designed according to generally accepted codes of practice, e.g. according to DVGW W 400-I (2015)

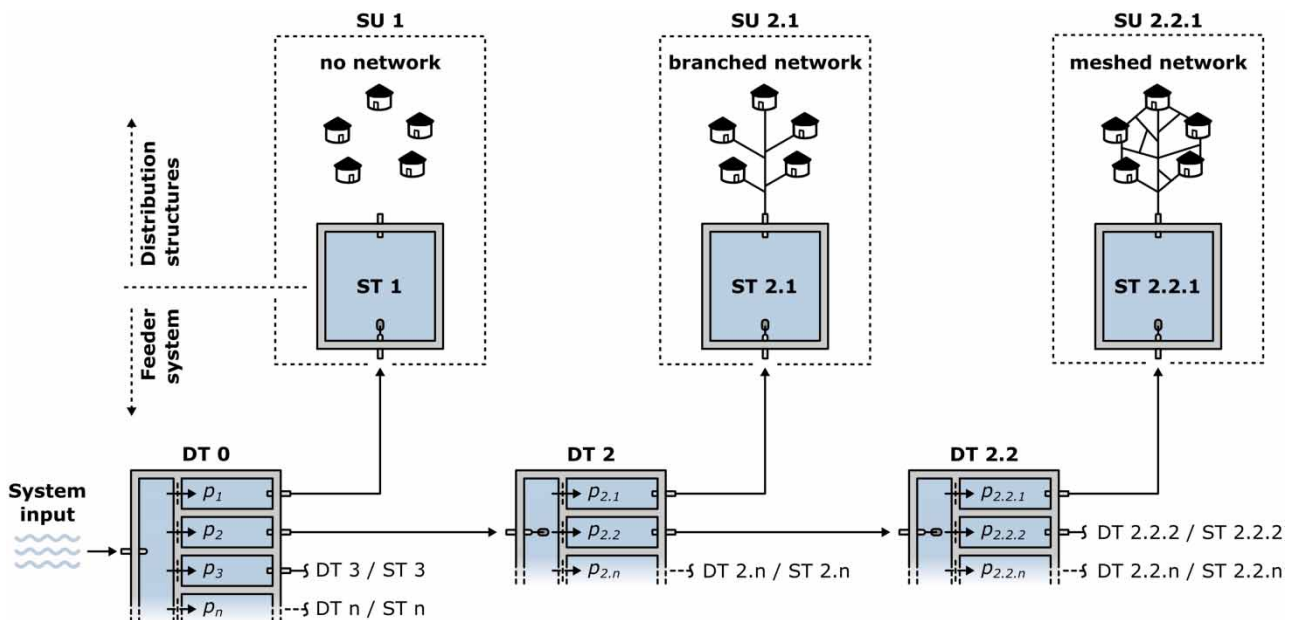

Figure 2 | System concept, components and division of the system input (DT: distribution tank, p : percentage of inflow, ST: storage tank, SU: supply unit).

and DVGW W 410 (2008). Due to the compensation of demand fluctuations in the STs, the entire feeder system can be designed economically based on the maximum daily demand. Hence, a design based on the maximum hourly demand is only necessary for the distribution structures between STs and consumers.

Due to the atmospheric pressure inside the DTs and STs, these components must therefore be arranged along a system branch at successively decreasing elevations. Since the feeder pipes always connect two components, the flow rate in a connecting pipe section depends on the elevation difference of the components, the length of the pipe section, the pipe diameter and the continuous and local energy losses. The locations of the DTs therefore have a direct influence on the system layout. Depending on the design flow rate and pipe lengths, it is important to choose elevations that allow the smallest possible pipe diameters in the overall system to attain an economic system dimensioning.

Depending on the water availability and demand situation, an emptying, filling or partial filling of the pipe system must be taken into account. However, a non-permanently filled pipe system has negative impacts on water quality and system operation. Particles can be intruded into empty pipe sections through leaks, or air pockets can arise during the filling process and cause a flow reduction. The elevation profile of the pipe routing has a significant influence on the characteristics of these negative effects.

Typical pipe routings are shown in Figure 3. In routings with a continuously decreasing elevation profile or with a pronounced low point, an even emptying and filling results. Any air present is discharged independently at the upper end of the pipe with the rise in water level. Furthermore, air is intruded into the flow and is transported to the lower end of the pipe by the turbulent interaction between gravity and pressure flow (Kalinske & Robertson 1943). While pipes with a decreasing elevation profile empty completely, a pronounced low point ensures a constantly filled

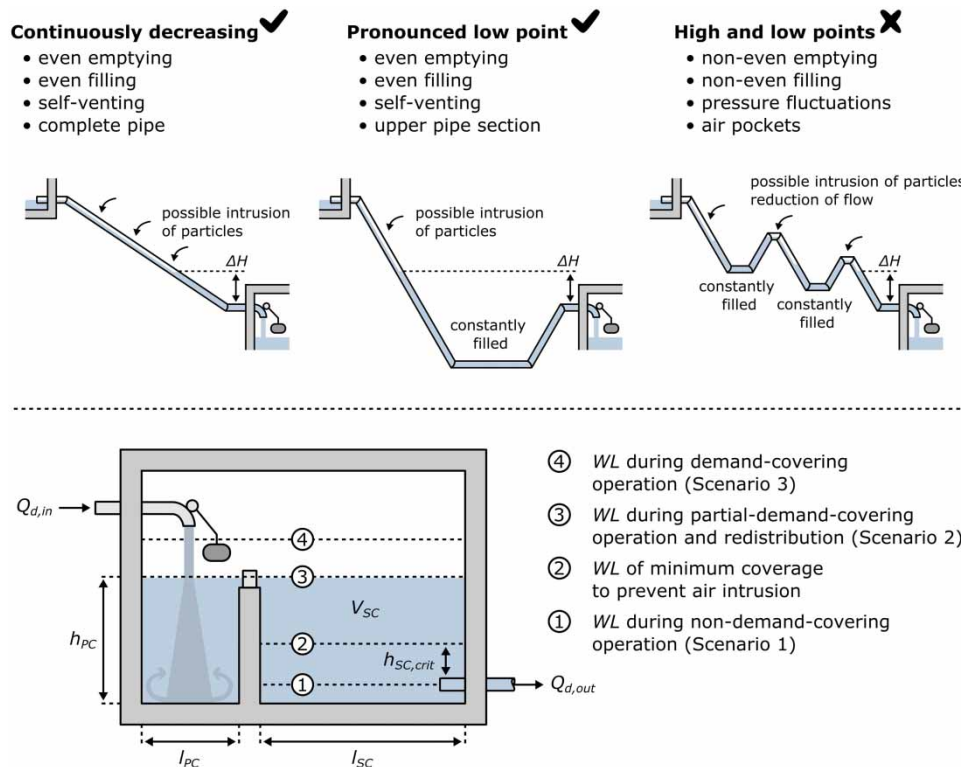

Figure 3 | Possible pipe routings with respective advantages and disadvantages (top) and schematic intersection of a DT with design parameters (bottom) (ΔH : height of filled pipe section above inflow, h_{PC} : pre-chamber height, $h_{SC,crit}$: sub-chamber minimum coverage, l_{PC} : pre-chamber length, l_{SC} : sub-chamber length, $Q_{d,in}$: design inflow, $Q_{d,out}$: design outflow, V_{SC} : fluctuating sub-chamber volume, WL: water level).

section. Hence, the negative effects are reduced to the part of the pipe with varying water level. If a certain altitude is to be maintained between the DTs, a large part of the connecting pipe can remain permanently filled if a distinct gradient can be accomplished at the beginning of the routing. In routings with several high and low points, a non-even emptying and filling results, which can lead to significant pressure fluctuations. In addition, air pockets form in the downwardly inclined sections, which lead to a reduction in the hydrostatic pressure energy. This leads to a reduction of the flow or a complete prevention of the flow movement (Aigner 2003). Therefore, such a routing should be avoided. Otherwise, a discharge of the air pockets must be guaranteed by air valves. However, in developing and emerging countries, air valves are a common cause of water losses due to deficient maintenance management. Hence, it is recommended to first check the self-venting capability of the pipe, e.g. according to Aigner (2003) or Horlacher & Helbig (2018).

Distribution tanks

Since DTs have no storage function, the hydraulic dimensioning cannot be carried out by determining the necessary storage volume. Therefore, the design aims at a sufficient volume of the PC and SCs to ensure a proper operation during the operating scenarios described in the previous section. The chamber volumes are determined as a function of the design inflow rate $Q_{d,in}$ and the design outflow rate $Q_{d,out}$. These design flows result from the hydraulic dimensioning of the pipe system, see previous section.

In order to ensure a proper operation of the float valve and the weir overflows, a sufficient energy dissipation of the inflow must occur in the PC. If the water level is too unsteady, it would result in a falsification of the division and an oscillating opening and closing of the float valve during demand-covering operations. The energy input takes place in form of a free jet, see Figure 3. The length of the free jet potential core depends on the diameter D_{in} of the inlet pipe and is approximately $5 \times D_{in}$. The major part of the kinetic energy has already been dissipated at a distance of $10 \times D_{in}$ (Schlichting & Gersten 2006). Hence, a minimum height of $h_{PC} \geq 10 \times D_{in}$ is defined for the height h_{PC} of the PC. This height corresponds to the

necessary height of the weir top edge. The jet angle of a free jet is approximately 20° . In order to achieve sufficient energy dissipation at the bottom of the PC, there must be a certain distance between the outer edge of the jet and the wall to prevent a backflow swelling upwards. This distance should be equivalent to the jet radius on the chamber floor. Depending on the jet angle and the chamber height h_{PC} or the diameter D_{in} , respectively, a minimum length of the PC of $l_{PC} \geq 40 \times \tan(10^\circ) \times D_{in}$ results. Since a DT consists of at least two SCs, the defined dimensions result in a sufficient width w_{PC} and thus a sufficiently large volume of the PC to ensure sufficient energy dissipation.

The SCs should be dimensioned in such way that a short-term withdrawal in an SU, which exceeds the inflow into the SC, does not lead directly to an emptying of the chamber and an entry of air into the system. Conservatively neglecting the inflow, the chamber volume V_{SC} is determined so that an emptying of the SC is prevented for a defined period. In a first application of the solution a duration of $t = 15$ min has proven to be effective for SCs that feed water directly into an SU (see Application). In the SU, an amount of water equivalent to the 15-min design flow can be withdrawn without emptying the system. For SCs that feed water into a DT, a duration of $t = 5$ min is advisable due to the buffer effect of the downstream DT. The fluctuating chamber volume then results from $V_{SC} = Q_{d,out} \times t$. In addition, there is the dead storage volume below the outlet pipe and a volume for realising the minimum coverage $h_{SC,crit}$ above the outlet pipe. The minimum coverage $h_{SC,crit}$ prevents air intrusion through the formation of eddies and can be determined according to Knauss (1987).

After determining h_{PC} , l_{PC} , $h_{SC,crit}$ and V_{SC} , the width w_{SC} and length l_{SC} of the SC can be selected. It is recommended that all SCs of a DT have the same dimensions. Although this can result in conservative overdimensioning of some chambers, it eases planning, construction and operation of the system. Furthermore, with the same widths of the SCs, identical weir overflow systems can be installed. This facilitates their production and leads to an easier understanding of the division of the water. It is also advisable to choose $w_{SC} \geq l_{PC}$ to allow for sufficient energy dissipation within the PC, whereby the construction

of the weir overflow system and the setting of possible weir widths should also be taken into account.

MODELLING

Numerical simulations of the water distribution and redistribution are helpful for system planning and analysis. For simulations, a pipe network model can be applied. With exception of the DTs, the components of the system can be commonly modelled as described by Klingel (2018) and Rossman *et al.* (2020). The modelling of a DT needs to consider the filling and emptying of the chambers, the division of the water input from the PC to the SCs, the backlog from the SCs to the PC and the redistribution during a backlog.

Figure 4 shows a schematic node-link-model of a DT. PC and SCs are modelled as separate tanks with the bottom elevation $h_{geo,tank}$. By assigning a short length and a low roughness to the pipes connecting the tanks, the hydraulic impact of these pipes is negligible. For the diameter of the connecting pipes, the diameter D_{in} should be chosen because the division of the water input is realised by local minor losses assigned to the pipes which depend on the flow velocity, see Equation (1). In most modelling software, tank inlets are assumed to be at the bottom elevation, hence, the input flow

depends on the water level. The tank inlet that discharges above the water level is modelled by using a pressure sustaining valve. The pressure setting of the valve should be zero and the elevation should equal the inlet elevation $h_{geo,inlet}$. The floating valve at the inlet pipe is modelled with a control rule which closes the inlet pipe when the maximum water level WL_{max} is reached and opens when the water level is below WL_{max} .

The weirs are implemented as pressure sustaining valves, with pressure settings zero and elevations equal to the geodetic elevations of the weirs $h_{geo,weir}$. As soon as the water level of the PC reaches the elevation of the weir the pressure sustaining valve opens and a discharge into the SC occurs. When the SC water level reaches the water level of the PC the hydraulic grade line is horizontal and, thus, the discharge is zero. In case the demand is fully met (demand-covering operation), the respective SC is filled and the discharge equals the demand. The excess water leads to a rising water level in the PC and, thus, to an increase of the discharges into the other SCs of the DT.

The water division is realised by local minor losses assigned to the inlet pipes of the SCs (L4 and L8 in Figure 4). By defining a short pipe length of, e.g. 0.1 m, and a small roughness of, e.g. 0.1 mm, the continuous friction losses are negligible. At the input side of the inlet pipes of the SCs, the pressure head H is the same as it

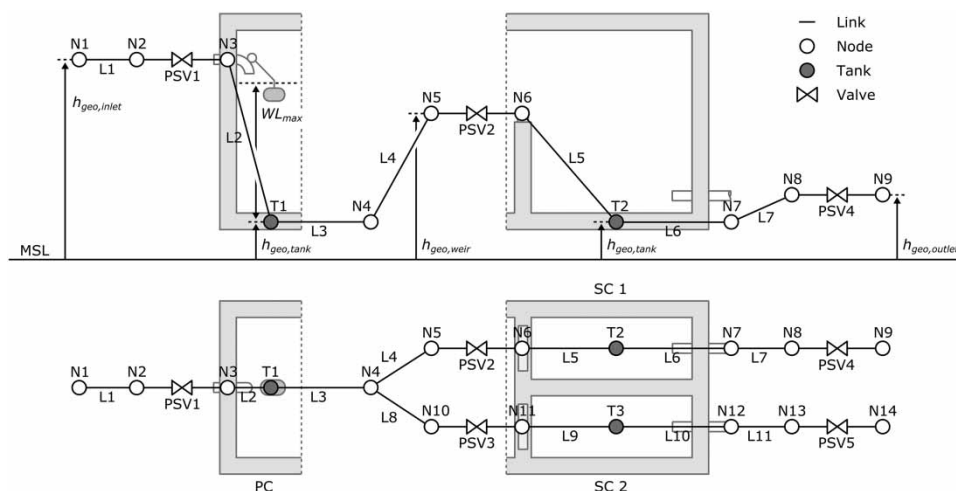

Figure 4 | Schematic sketch of a DT model (h_{geo} : geodetic elevation, L: link, MSL: mean sea level, N: node, PC: pre-chamber, PSV: pressure sustaining valve, SC: sub-chamber, T: tank, WL: water level).

equals the geodetic elevation of the PC water level. Hence, the energy losses and, thus, the discharges into the SCs solely result from the minor losses $h_{minor} = \zeta \cdot v^2 / (2g)$ where the loss coefficient is ζ , the velocity v and the gravitational acceleration constant g . Thus, the division of the tank input can be defined by the loss coefficients ζ_n of the pipes. The following proportionality law can be formulated for calculating the loss coefficients ζ_n in dependence of the tank input percentages p_n (%) of

each pipe:

$$H = \zeta \cdot \frac{v^2}{2g} \rightarrow Q \sim \sqrt{\frac{1}{\zeta}} \rightarrow \zeta_n = \frac{1}{(p_n \cdot 0.01)^2} \quad (1)$$

The discharges in the outlet pipes of the SCs are controlled by pressure sustaining valves, with pressure settings zero and elevations equal to the geodetic elevation $h_{geo,outlet}$. In case of no coverage of the demand (non-demand-covering operation), the inflow equals the outflow.

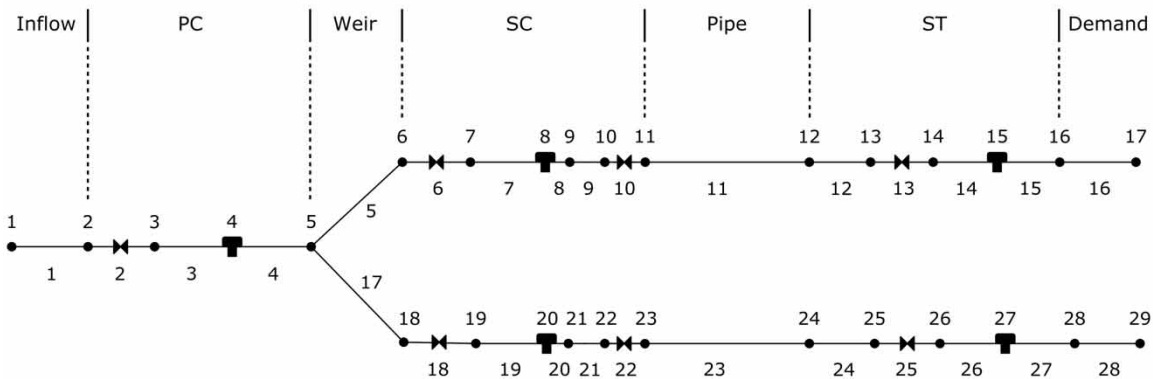
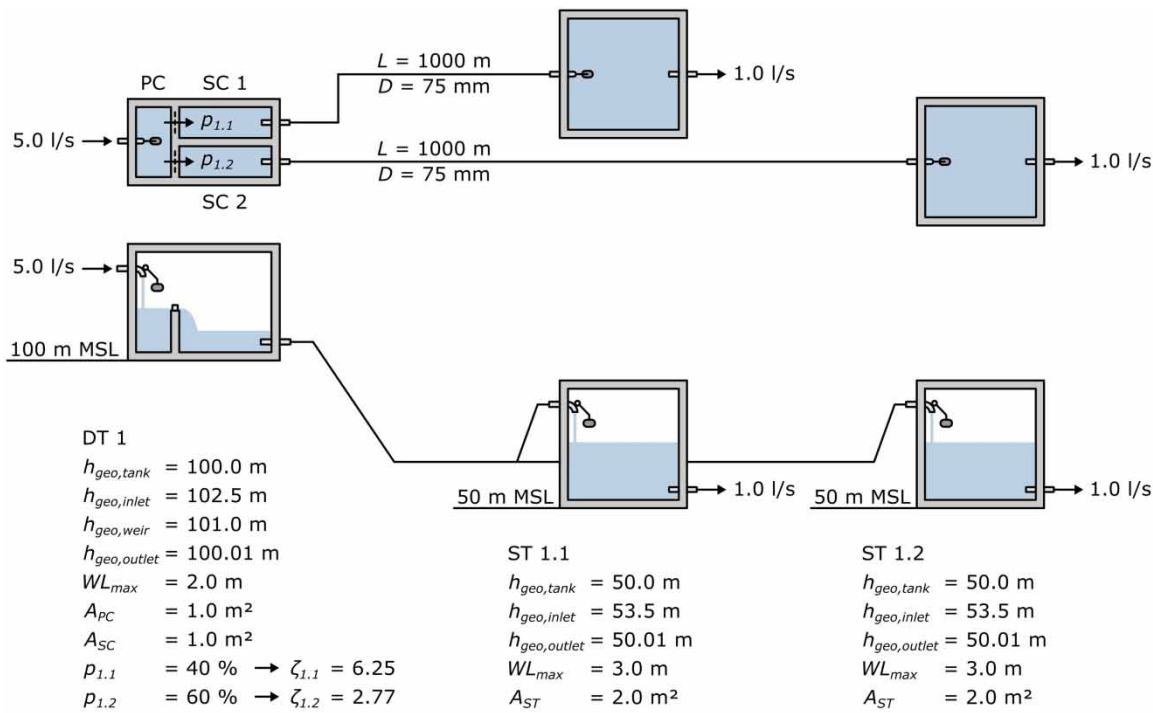

Figure 5 | Plan and profile (top) and EPANET-model (bottom) of the minimal example system (A: area, D: pipe diameter, DT: distribution tank, h_{geo} : geodetic elevation, L: pipe length, MSL: mean sea level, p: percentage of inflow, PC: pre-chamber, SC: sub-chamber, ST: storage tank, WL: water level, ζ : loss coefficient).

It has to be considered that pipes are assumed to be always totally filled and under pressure for the interpretation of the simulation results. The filling and emptying processes of the pipe system cannot be simulated using pipe network modelling tools. This leads to a time shift regarding the tank filling in the simulation results compared to the reality. However, there is no falsification of the simulation results of the water division, distribution and redistribution.

A minimal example system comprising a DT and two STs is shown in Figure 5. The simulated water levels are shown in Figure 6. In the example, the system input is 5.0 l/s and the demands are 1.0 l/s each. The water division in the DT is $p_{1.1} = 40\%$ and $p_{1.2} = 60\%$. Figure 5 also shows the model of the system implemented with the Open-Source Software EPANET (Rossman *et al.* 2020). The EPANET-model is provided in the Supplementary Material to this paper.

At the start of the simulation all tanks are empty. Then, only the PC of the DT is filled. When the PC is filled at t_1 , water discharges through the SCs to the STs. According to the division percentages, the ST 1.2 is filled faster. At t_2 ST 1.2 is filled. At the same time, SC 2 is starting to fill due to the backlog. At t_3 , SC 2 is filled and excess water flows to ST 1.1 via SC 1. This results in an increased filling of ST 1.1, which is filled at t_4 . Due to the backlog, SC 1 is filled as well until t_5 . At t_6 , both SCs and the PC are filled. The inflow is throttled by successive opening and closing of the floating valve so that it equals the demand.

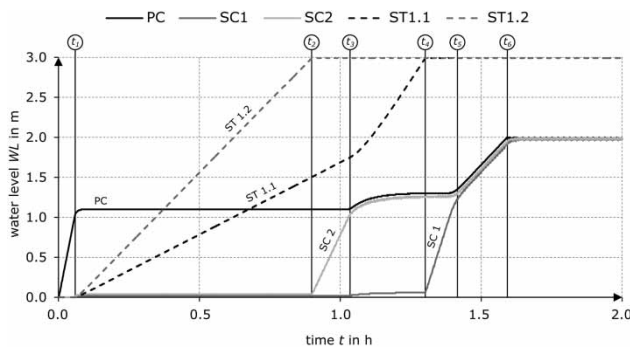

Figure 6 | Simulation results (PC: pre-chamber, SC: sub-chamber, ST: storage tank).

APPLICATION

The technical solution presented in the previous sections was implemented in the district Dong Van, Ha Giang province in northern Vietnam. The annual precipitation in the region is 1,3600 mm. However, 84% of the rain falls in the rainy season during the summer months (Climate-Date.org 2020). The supply area comprises an urban area, approximately 4,300 inhabitants of the district capital Dong Van city, and a rural area with a population of approximately 2,500 people. The rural population lives in 13 settlements with approximately 40–300 inhabitants in each settlement. The supply area is economically and technically less developed than average Vietnam. Approximately 47% of the inhabitants of Dong Van city and the total rural population live below the poverty line (Zindler & Stolpe 2018).

The water supply of 45% of the Dong Van city citizens solely depends on a deficient water distribution system which is operated intermittently. The rural population and 55% of the inhabitants of Dong Van city predominantly apply privately implemented individual water supply solutions (Klingel Oberle & Nestmann 2016; Ender 2019; Pham 2019). According to Zindler & Stolpe (2018), the water demand in Dong Van city is approximately 135 l/cap/d, including commercial water demand. Five percent of the citizens face water scarcity during the rainy season, while this is 35% during the dry season. The current water demand of the rural population is 20 l/cap/d, including the water demand of livestock. The relatively low value is mainly due to the limited water availability, the effort associated with water collection (on average it requires 60 min to collect 20 l) and the economical consumption. During the rainy season approximately 45% of the rural population faces water scarcity; in the dry season it is 97%.

The topology of the implemented water distribution system and its components is shown in Figure 7. Water from the Seo Ho River is pumped to the central distribution tank (DT 0) located approximately 550 m above the pump station in the settlement Ma U. The pump station comprising two parallel pumps is driven by hydro power. Depending on the river discharge, none, one or two of the pumps can be operated. Accordingly the pumping rate is

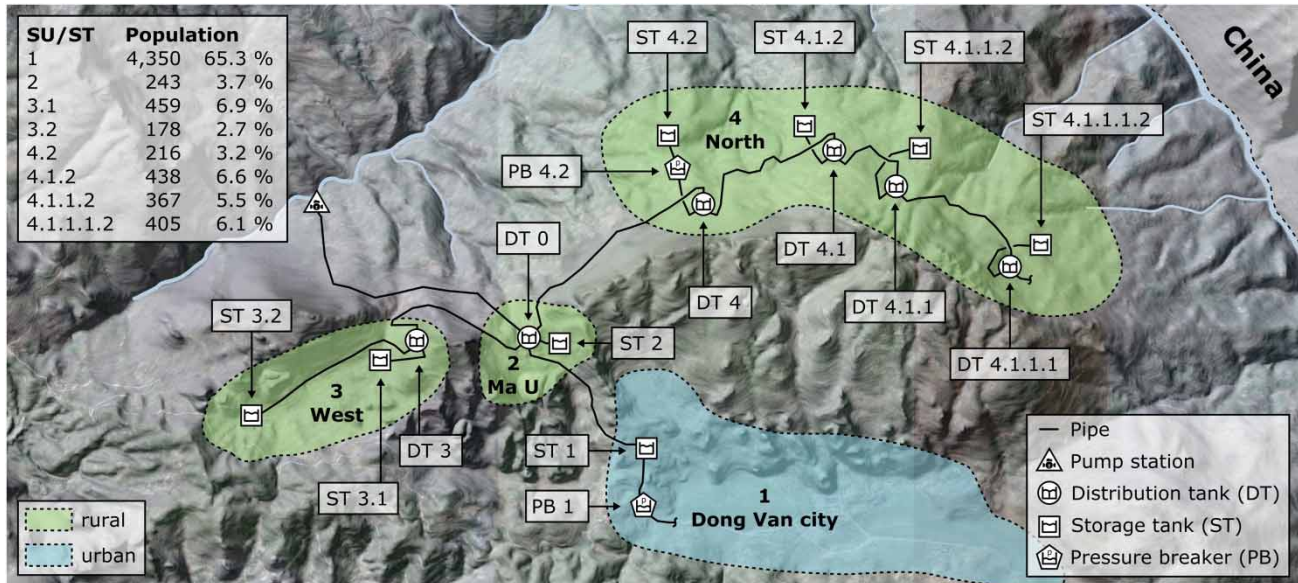

Figure 7 | Topology of the water supply system with substantial components and division of the water within the main supply areas (SU: supply unit).

0 l/s, approximately 9.5 l/s or approximately 18.4 l/s, respectively. The varying pumping rates lead to demand-covering and non-demand-covering operation scenarios within the supply area (Oberle *et al.* 2017; Walter 2020).

The first division of the system input into the four main supply areas Ma U, Dong Van city, West and North takes place at DT 0 (Figure 7). The ST of the settlement Ma U and Dong Van city are directly connected to DT 0. Due to the elevation difference, a pressure breaker is necessary between ST 1 and the distribution network of Dong Van city. Within the supply area West, the water is distributed to two STs by DT 3. The supply area North comprises four DTs and four STs. Some settlements share one ST. The varying system input is distributed to the STs proportionally to the assigned numbers of consumers.

The design flows were determined considering a demand-covering supply scenario and filled system components, as described in the Design section. In order to keep the distribution system simple and to reduce the effort for planning, construction and operation, all DTs are of the same type with similar dimensions except the central DT. To fulfil the function of distributing water, the central DT 0 requires a total volume (between bottom and ceiling) of approximately 57 m³ with a chamber volume (between bottom and weir top edge) of the PC of approximately

8.8 m³ and of the four SCs of approximately 7.2 m³ each. However, a total volume of 205 m³ was chosen to realise additional water storage. All other DTs only require two SCs. The minimum chamber volume is approximately 0.7 m³ for a PC and approximately 0.8 m³ for each SC. The total volume is approximately 6.0 m³. Figure 8 shows components of the main supply area West: DT 0 (under construction), DT 3 (under construction) and ST 3.1. The weir overflows are made of steel and concrete elements.

The pipe system comprises steel pipes with diameters from 25 mm (connections of the ST in the three rural supply areas) up to 125 mm (branch to Dong Van city). By taking advantage of the pronounced elevation differences in the supply area, the design criteria regarding the elevation profile of the pipe sections – distinct gradients at the beginning and a pronounced low point – could be met. Measurements during operation showed a deviation of 2–3% between planned and measured water division within the system. The deviation is mainly caused by the large differences of the weir widths inside the central DT, imprecise manufactured steel and concrete elements and the simple methods applied to install the weir overflows. However, the deviation is acceptable; the functionality of the DT could be demonstrated. A comparison of calculated and measured discharges showed only small deviations. For



Figure 8 | DT 0 (under construction) with inside view (top left), DT 3 (under construction) with inside view (top right) and ST 3.1 in supply area West (bottom).

example, in section DT 0 to DT 3 the calculated discharge for a specific operation scenario is 1.25 l/s while the measured discharge is 1.29 l/s. The self-venting of the system was successfully tested by analysing extreme

operation scenarios in section DT 0 to ST 1. The evaluation of simulation results and operation parameters measured in the supply area West showed that the simulation model delivers meaningful results.

CONCLUSION

The technical solution presented in this paper allows for a controlled and planned distribution of a limited and fluctuating water availability within a supply area, in which the distribution cannot be influenced by consumption patterns. In this way, the fair distribution of a non-demand-covering water supply can be realised in water-scarce areas.

The principle of the approach is the transmission of the water storage towards the consumers and the division of the system input within a branched distribution system by so-called distribution tanks. Due to the decentralised water storage, the influence of consumer behaviour on the system hydraulics is limited to the system parts after storage. In contrast to a conventional centralised water distribution, the consumer behaviour cannot influence the division of the water availability. A DT is arranged at each junction of the branched pipe network to divide the flow. Each DT consists of a PC and several SCs. SCs are connected to the pre-chamber by weir overflows with variable weir widths. The inflow into the PC is divided proportionally to the weir widths into the SCs and thus into the system branches. If the demand is covered in a system branch, the flow is backed up and redistributed within the rest of the system. If the demand exceeds the allocated portion of the available water, the system branch runs empty.

The water division by weir overflows is simple and transparent. If a system is set, no personnel are required for the standard operation and control. The proportional water distribution to the supply units is regulated automatically. The maintenance effort is low due to components of limited complexity, simple constructions and simple fittings (float valves, shut-off valves).

A crucial prerequisite limiting the application of the solution are sufficient elevation differences within the supply area, which enable gravitational water transport and pipe routing in accordance with the design criteria. The water resources do not necessarily have to be higher than all consumers. In order to use spatially distributed water resources, additional system inputs can also be connected at lower-lying DTs.

Since the system design includes the temporary emptying of the system, a deterioration of the water quality must

be accepted. However, the deterioration is probably smaller than in a 'classic' intermittent system because negative pressures are not occurring and, thus, the potential for the intrusion of contaminants is decreased. This deterioration is also deliberately tolerated, in favour of the plannable and controllable water distribution, the robust and low-maintenance system structure and the self-acting operation – aspects that are crucial for the sustainable implementation of the solution in lower developed regions. It is also possible to complement the distribution system with semi-central or decentralised solutions for water treatment.

With the theoretical planning and a first implementation in the supply area Dong Van, it has been shown that the outlined solution can achieve a planned and fair distribution of a limited and fluctuating water availability with low maintenance and operating efforts. The modelling could possibly be improved by applying storm water models to consider time-dependent filling and emptying of the pipe system.

ACKNOWLEDGEMENTS

The presented work was funded within the framework of the projects KaWaTech (FKZ: 02WCL1291A) and KaWaTech Solutions (FKZ: 02WCL1415) as part of the funding programme CLIENT of the German Federal Ministry of Education and Research (BMBF). The presented work was mainly developed while the authors were employed at the Institute for Water and River Basin Management (IWG) at the Karlsruhe Institute of Technology (KIT). The authors thank KIT and BMBF for the support.

DATA AVAILABILITY STATEMENT

All relevant data are included in the paper or its Supplementary Information.

REFERENCES

Aigner, D. 2003 *Lufttransport in (Wassergefüllten) Rohrleitungen (Air Transportation in Pipes (Filled with Water))*.

- Wasserbauliche Mitteilungen, 26, Institut für Wasserbau und Technische Hydromechanik, Dresden, Germany.
- Aleixo, B., Rezende, S., Pena, J. L., Zapata, G. & Heller, L. 2016 [Human right in perspective: inequalities in access to water in a rural community of the Brazilian northeast](#). *Ambiente & Sociedade* **19** (1), 63–84.
- Ameyaw, E. E., Memon, F. A. & Bicik, J. 2013 [Improving equity in intermittent water supply systems](#). *Journal of Water Supply: Research and Technology – AQUA* **62** (8), 552–562.
- Callebat, L. 1973 *Vitruve – De L'architecture – Livre VIII*. Les Belles Lettres, Paris.
- Climate-Data.org. 2020 [Đông Văn Climate \(Vietnam\)](https://en.climate-data.org/asia/vietnam/ha-giang-province/%c4%91ong-van-974322/). Available from: <https://en.climate-data.org/asia/vietnam/ha-giang-province/%c4%91ong-van-974322/> (accessed 1 August 2020).
- de Montauzan, C. G. 1908 *Les Aqüeducs Antiques de Lyon: Étude Comparée D'archéologie Romaine*. Ernest Leroux, Paris.
- DVGW W 400-1 (A) Technische Regeln Wasserverteilungsanlagen (TRWV); Teil 1: Planung (DVGW W 400-1 (A) Technical guideline water distribution systems; part 1: planning). 2015 DVGW Deutscher Verein des Gas- und Wasserfaches e. V., Bonn, Germany.
- DVGW W 410 (A) Wasserbedarf – Kennwerte und Einflussgrößen (DVGW W 410 (A) Water demand – specific values and influencing factors). 2008 DVGW Deutscher Verein des Gas- und Wasserfaches e. V., Bonn, Germany.
- Ender, A. F. 2019 *Evaluation of Highly Variable Water Quality as Basis for A Sustainable Water Supply in the Dong Van Karst Region, Northern Vietnam*. Dissertation, Fakultät für Bauingenieur-, Geo- und Umweltwissenschaften, Karlsruher Institut für Technologie (KIT), Karlsruhe, Germany. <https://doi.org/10.5445/IR/1000083139>.
- Horlacher, H. B. & Helbig, U. 2018 *Rohrleitungen 2: Einsatz, Verlegung, Berechnung, Rehabilitation (Pipes 2: Application, Implementation, Calculation, Rehabilitation)*. Springer, Berlin, Germany.
- Kalinske, A. A. & Robertson, J. M. 1943 [Entrainment of Air in flowing water: a symposium: closed conduit flow](#). *Transactions of the American Society of Civil Engineers ASCE* **108** (1), 1435–1447.
- Klingel, P. 2012 [Technical causes and impacts of intermittent water distribution](#). *Water Science & Technology: Water Supply* **12** (4), 504–512. <https://doi.org/10.2166/ws.2012.023>.
- Klingel, P. 2018 *Modellierung von Wasserverteilungssystemen (Modelling of Water Distribution Systems)*. Springer Vieweg, Wiesbaden, Germany. <https://doi.org/10.1007/978-3-658-21270-4>.
- Klingel, P. & Nestmann, F. 2014 [From intermittent to continuous water distribution: a proposed conceptual approach and a case study of béni abbès \(Algeria\)](#). *Urban Water Journal* **11** (3), 240–251.
- Klingel, P., Oberle, P. & Nestmann, F. 2016 [Innovative technologies for the sustainable water supply in a rural karst area of Vietnam](#). *Water Solutions* **2** (2016), 38–43.
- Knauss, J. 1987 *Swirling Flow Problems at Intakes, Hydraulic Structures Design Manual*. Balkema Publishers, Rotterdam.
- Kretschmer, F. 1983 *Bilddokumente römischer Technik (Photo Documents of Roman Technic)*. VDI-Verlag, Düsseldorf.
- Kumpel, E. & Nelson, K. L. 2016 [Intermittent water supply: prevalence, practice, and microbial water quality](#). *Environmental Science and Technology* **50** (2), 542–553.
- Mara, D. & Evans, B. 2011 *Sanitation and Water Supply in Low-Income Countries*. Ventus Publishing ApS, Frederiksberg, Germany.
- Oberle, P., Stoffel, D., Walter, D., Breiner, R., Vogel, M., Müller, H. S. & Nestmann, F. 2017 [Innovative Technologien zur Wasserförderung und -verteilung in Gebirgsregionen \(Innovative technologies for water pumping and distribution in mountain regions\)](#). *Bautechnik* **94** (8), 514–525.
- Ohlig, C. 2004 *Wasserbauten im Königreich Urartu und weitere Beiträge zur Hydrotechnik in der Antike (Water Buildings of the Urartu Kingdom and Further Contributions to Ancient Hydro Technologies)*. Schriften der Deutschen Wasserhistorischen Gesellschaft (DWhG), Band 5, Books on Demand, Norderstedt, Germany.
- Ohwo, O. 2019 [Dimensions of inequality in urban and rural water, sanitation and hygiene services in Sub-Saharan Africa](#). *European Scientific Journal* **15** (8), 144–162.
- Perrault, C. 1684 *Les dix Livres D'architecture de Vitruve*. Jean-Baptiste Coignard, Paris.
- Pham, T. T. 2019 *Technical Performance Indicators for Small-Sized Water Supply Networks – Case Study in Dong Van City, Vietnam*. Dissertation, Fakultät für Bauingenieur-, Geo- und Umweltwissenschaften, Karlsruher Institut für Technologie (KIT), Karlsruhe, Germany. <https://doi.org/10.5445/IR/1000092685>.
- Rossman, L., Woo, H., Tryby, M., Shang, F., Janke, R. & Haxton, T. 2020 *EPANET 2.2 User Manual, Report EPA/600/R-20/133*. U.S. Environmental Protection Agency, Washington, DC, USA.
- Schlichting, H. & Gersten, K. 2006 [Grenzschicht-Theorie](#). <https://doi.org/10.1007/3-540-32985-4> (*Boundary Layer Theory*). Springer, Berlin Heidelberg.
- Simukonda, K., Farmani, R. & Butler, D. 2018 [Intermittent water supply systems: causal factors, problems and solution options](#). *Urban Water Journal* **15** (5), 488–500.
- Stübinger, O. 1909 *Die römischen Wasserleitungen von Nîmes und Arles (The roman water pipes in Nîmes and Arles)*. Winter, Heidelberg.
- Sutton, S. 2004 *Self Supply: A Fresh Approach to Water for Rural Populations*. Field note, Water and Sanitation Program, Nairobi, Kenya and the Rural Water Supply Network, St. Gallen, Switzerland.
- UNICEF & WHO. 2015 *Progress on Sanitation and Drinking Water – 2015 Update and MDG Assessment*. Report, United Nations Children's Fund (UNICEF) and World Health Organization (WHO), Geneva, Switzerland.
- van den Bosch, B. E., Snellen, W. B., Brouwer, C. & Hachó, N. 1993 *Structures for Water Control and Distribution, Irrigation Water*

- Management, Training Manual No. 8.* Food and Agriculture Organization of the United Nations, Rome, Italy.
- Walter, D. 2020 *Wasserverteilungssysteme zur Umsetzung Einer Gerechten Verteilung Eines Limitierten Wasserdargebots (Water Distribution Systems to Implement an Equatable Distribution of Limited Water Supplies)*. Dissertation. Fakultät für Bauingenieur-, Geo- und Umweltwissenschaften, Karlsruher Institut für Technologie (KIT), Karlsruhe, German.
- Zelenika, M. 1991 Application of appropriate technology for rural water supply. *Rudarsko-geolosko-naftni Zbornik* **3** (1991), 85–88.
- Zindler, B. & Stolpe, H. 2018 *FuE-Verbundvorhaben KaWaTech: Vietnamesisch-Deutsche Kooperation zur Entwicklung nachhaltiger Technologien für die Karstwasserwirtschaft, Teilprojekt 7, Ländliche Entwicklung, Ressourcenschutz und soziokulturelle Aspekte (R&D-Project KaWaTech: Vietnamese-German Cooperation for the Development of Sustainable Technologies for Karst Water Management, sub Project 7, Rural Development, Resources Protection and Socio-Economic Aspects)*. Report, Umwelttechnik und Ökologie im Bauwesen, Ruhr-Universität Bochum, Bochum, Germany.

First received 31 October 2020; accepted in revised form 12 January 2021. Available online 27 January 2021