

Development of ANN model for discharge prediction and optimal design of sharp-crested triangular plan form weir for maximum discharge using linked ANN–optimization model

Md. Ayaz and Talib Mansoor

ABSTRACT

Triangular plan form weirs are advantageous over a normal weir in two ways. Within the limited channel width, use of such a weir increases the crest length and hence for a given head, increases the discharge and for a given discharge, reduces the head in comparison with a normal weir. In a previous study, researchers proposed an empirical equation to compute the discharge coefficient of a triangular plan form weir. The prediction error on the discharge coefficient was $\pm 7\%$ from the line of agreement. In the present study, an ANN model has been utilized to train randomly selected 70% data, with 15% tested and validation made for the remaining 15% data. The model predicts the discharge coefficient with a prediction error in the range of $\pm 2.5\%$ from the line of agreement, thereby decreasing the prediction error in C_d by 64%. Also, the sensitivity analysis of the developed ANN model has been performed for all the parameters (weir height, skew weir length and flow depth) involved in the study and the weir height was found to be the most sensitive parameter. Furthermore, the linked ANN–optimization model has been developed to find the optimal values of design parameters of a triangular plan form weir for maximum discharge.

Key words | artificial neural network, discharge coefficient, discharge measurement, optimization, triangular plan form weir

Md. Ayaz (corresponding author)
Civil Engineering Section, University Polytechnic,
Faculty of Engineering and Technology,
Aligarh Muslim University,
Aligarh 202002,
India
E-mail: ayaz.math@gmail.com

Talib Mansoor
Civil Engineering Department, Zakir Husain College
of Eng. & Tech., Faculty of Engineering and
Technology,
Aligarh Muslim University,
Aligarh 202002,
India

HIGHLIGHTS

- The developed ANN model shows significant improvement in the estimation of discharge coefficient and reduces the prediction error in C_d by 64%.
- The ANN model appears to be robust even for large random error levels up to 10% in the input parameters.
- Linked ANN–optimization model has been developed to find the optimal values of design parameters of weir L , w and h for which the discharge Q is maximum.

INTRODUCTION

Weirs are widely used as flow diversion and flow measuring devices particularly in irrigation engineering. The alignment

This is an Open Access article distributed under the terms of the Creative Commons Attribution Licence (CC BY 4.0), which permits copying, adaptation and redistribution, provided the original work is properly cited (<http://creativecommons.org/licenses/by/4.0/>).

doi: 10.2166/ws.2021.067

of a weir with respect to the channel axis plays an important role in influencing the discharge characteristics. Based on the alignment, weirs can be classified into three categories, namely, normal weir, side weir, and triangular plan form weir. In normal weirs, the channel axis is perpendicular to the weir axis; whereas, in side weirs, the channel axis is

parallel to the weir axis. The triangular plan form weir is the generalized form of normal weir and side weir in which the channel axis is inclined to the weir axis (Figures 1 and 2). The main advantage of using a triangular plan form weir is that it reduces the head required for higher discharge within the limited channel width. Moreover, in this weir type, the effective weir length increases beyond the channel width. Consequently, it reduces the water head and increases the efficiency of the weir. The discharge Q over a normal weir is usually expressed as:

$$Q = \frac{2}{3} C_d B h \sqrt{2gh} \quad (1)$$

where C_d = discharge coefficient; B = effective weir length; g = acceleration due to gravity; and h = head on weir.

Labyrinth weirs, which are similar to triangular plan form weirs, having one or multiple folds and of various plan forms viz., triangular, trapezoidal, rectangular etc., are also used in practice. Taylor (1968) used the same head over the crest to calculate the discharges of various types of labyrinth weirs and the corresponding normal weirs. He

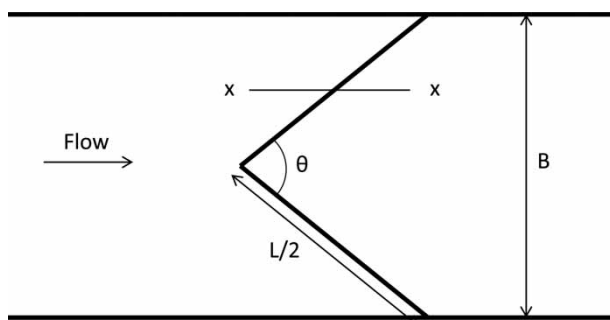

Figure 1 | Schematic representation of triangular plan form weir (plan view).

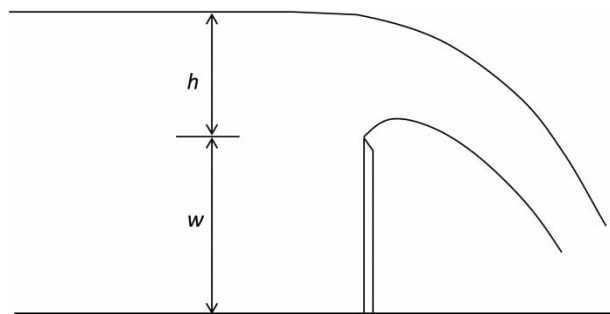

Figure 2 | Section about x-x of triangular plan form weir.

further calculated the magnification ratio, which is the ratio of discharge over a labyrinth weir to the discharge over a normal weir. Hay & Taylor (1969, 1970) developed a computer model to evaluate the performance of labyrinth weirs. They found that the efficiency of a triangular plan form weir is better than that of a trapezoidal plan form weir. Tullis *et al.* (2007) studied submerged labyrinth weirs of various geometries and developed head-discharge relationships. Wormleaton & Soufiani (1998) and Wormleaton & Tsang (2000) respectively studied the aeration performances of triangular and trapezoidal plan form labyrinth weirs. They reported that the aeration efficiency of a labyrinth weir is better than that of a normal weir of equivalent length. Similar to triangular plan form weirs, many researchers have studied the discharge characteristics of skew/oblique weirs of equivalent crest length. Some of the selected studies are reviewed below.

King *et al.* (1929) has given the following equation for discharge coefficient:

$$C_d = 0.61 + 0.08 \frac{h}{w} \quad \text{for } h/w < 5 \quad (2)$$

where w = weir height. Similar empirical formulae for calculation of discharge coefficient have been given by many researchers. Kandaswamy & Rouse (1957) conducted an experimental study on low weir height and proposed the following equation:

$$C_d = 1.06 \left(1 + \frac{w}{h}\right)^{1.5} \quad \text{for } h/w > 15 \quad (3)$$

Swamee (1988) proposed a full-range equation for discharge coefficient using the experimental data of Kandaswamy & Rouse (1957).

Aichel (1953) proposed the following equation for discharge over a sharp-crested skew weir:

$$Q = \frac{2}{3} C_d B h \sqrt{2gh} \operatorname{cosec} \theta \quad (4)$$

where θ = weir angle. In this study, Aichel related the discharge coefficient for a skew weir (C_d) to the corresponding discharge coefficient of a normal weir (C_{DN}) of identical geometry and the results were presented in tabular form

which were converted to the following equation by Swamee *et al.* (2011):

$$C_d = C_{DN} \left(1 - \frac{1}{1 + 3.7\phi^{1.17}} \frac{h}{w} \right) \quad (5)$$

where $\phi = 2\theta/(\pi - 2\theta)$. It was found that C_d increases with the increase in weir angle θ . Ganapathy *et al.* (1964) conducted an experimental study on a broad-crested skew weir and plotted curves for C_d versus h with θ as third parameter. They also found that C_d increases with θ . Borghei *et al.* (2003) conducted experiments on a sharp-crested skew weir for $26^\circ \leq \theta \leq 61^\circ$ and $0.08 \leq h/w \leq 0.2$ and proposed the following equation for discharge coefficient:

$$C_d = (0.701 - 0.121 \sin \theta) + (2.229 \sin \theta - 1.663) \frac{h}{w} \quad (6)$$

Tuyen (2006) studied the discharge characteristics of sharp-crested, broad-crested and trapezoidal skew weirs with weir angle $\theta = 45^\circ$. Based on the experimental results, it was concluded that the discharge over a skew weir is higher than that of a normal weir of identical geometry. Emiroglu *et al.* (2010) used an adaptive neuro-fuzzy technique to predict the discharge capacity of a labyrinth side weir. Ayaz & Mansoor (2018) developed an ANN model for estimation of the discharge coefficient of an oblique sharp-crested weir.

The literature reviewed above establishes the fact that a substantial amount of work has been done to develop methodologies for prediction of the discharge coefficient of weirs and efforts are still continuing to improve it. Many researchers have proposed various approaches to address this problem. Most of them have proposed empirical equations for calculation of the discharge coefficient C_d with h , w and θ as independent variables. Empirical equations generally have certain limitations in incorporating nonlinearity. On the other hand, the use of artificial neural networks (ANNs) has become popular in various areas of water resources engineering because of their capability of fitting complex nonlinear input-output relationships. ANNs are also known as universal approximators. Hornik *et al.* (1989) reported that any standard multilayer feed-forward network with a sufficient number of hidden units can approximate any measurable function to any degree of accuracy. In this study, ANNs have been used

to fit the nonlinear relation between h , w and θ or L and therefore, to predict the discharge coefficient of a sharp-crested triangular plan form weir.

Problem statement and highlights

Measurement of discharge plays an important role in the design and control of open channels and various flow diversion structures. Weirs are the most widely used discharge measuring devices in open channels. In order to measure the real-time data of discharge, first of all a weir needs to be calibrated by identifying its discharge coefficient (C_d). The problem statement of this study is to develop an ANN model to improve the predicted discharge coefficient of a sharp-crested triangular plan form weir which is already predicted by Kumar *et al.* (2011). Since the non-dimensional input and output parameters have been used in the proposed ANN model, therefore it will be applicable to all sharp-crested triangular plan form weirs which are used to measure real-time data. The discharge coefficient predicted by the proposed ANN model will work for all. A significant improvement can be observed in the prediction results. Also, a novel approach has been developed in this study by linking the developed ANN model with the optimization model to find the optimal design parameters of a weir which give the maximum discharge. The following are the highlights of this study:

1. The developed ANN model shows significant improvement in the estimation of discharge coefficient and reduces the prediction error in C_d by 64%.
2. The sensitivity analysis results show that the developed ANN model appears to be robust even for large random errors up to 10% in the input parameters.
3. A novel approach of linked ANN-optimization model has been developed to find the optimal values of design parameters (L , w and h) of a weir for which the discharge Q is maximum.

DATA COLLECTION

The experimental data collected by Kumar *et al.* (2011) has been used in this study. They conducted experiments in a

horizontal rectangular channel of length 12.0 m, depth 0.41 m and width 0.28 m. The plan view of the sharp-crested triangular plan form weir is shown in Figure 1 and the sectional elevation about the section $x-x$ is shown in Figure 2. The channel was constructed of concrete material. A triangular plan form weir made up of mild steel plates was installed at a distance of 11.0 m from the head of the weir at a desired angle θ and weir height w . Discharge Q was allowed into the channel with the help of a supply valve and the depth of flow was measured, when the condition became steady. A point gauge of accuracy ± 0.1 mm was used to measure the depth of flow. In order to minimize free surface disturbances, wave suppressors and grid walls were provided at the upstream end of the channel. The experiments were conducted on various sharp-crested triangular plan form weirs having vertex angles = 30° , 60° , 90° , 120° , 150° and 180° . For each vertex angle, many sets of experimental data were recorded by varying the discharge. A total number of 123 sets of experimental data were recorded corresponding to 123 different combinations of weir height, flow depth and weir angle. Ranges of experimental parameters of the triangular plan form weir are summarized in Table 1.

ARTIFICIAL NEURAL NETWORKS

Artificial neural networks (ANNs) are computational models inspired by the central nervous system: particularly, the brain. ANNs are used as nonlinear statistical data modeling tools to fit the complex relationship between inputs and outputs. The artificial neuron is the basic processing unit of an ANN model. ANNs usually comprise two or

more layers of processing units. Each neuron of a layer is connected to all the neurons of the next adjacent layer with associated weights. Input layer neurons receive the information and transmit it in the forward direction to the next layers through weighted connections. The hidden layer transforms the inputs with the help of nonlinear activation functions, such as the sigmoid function, into an alternative bounded space. This process continues until the output layer is reached. Such networks are known as feed-forward neural networks (FFNN). A detailed description of the origin and basic concepts of ANN and neural computing can be found in Zurada (1990) and Schalkoff (1997). The typical structure of a feed-forward neural network comprises an input layer, an output layer, and a hidden layer, as shown in Figure 3. The number of neurons in the input and output layers depends upon the problem being trained. The number of hidden layers in the network depends on the complexity of the problem, and it may be increased for complex problems to fit the input-output

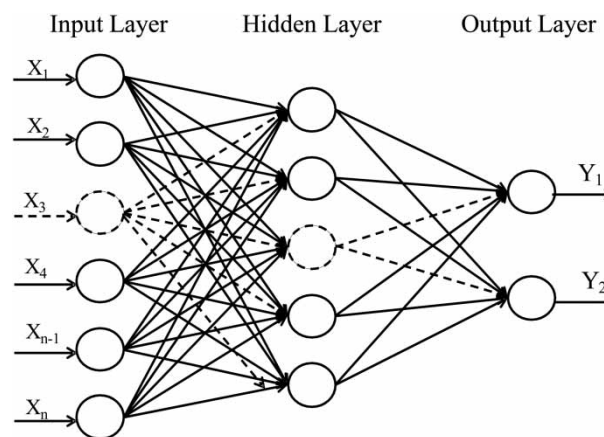

Figure 3 | Typical structure of ANN model.

Table 1 | Ranges of experimental data collected by Kumar et al. (2011)

S. no.	θ (degree)	w (m)	h (m)	Q (m ³ /s)	Number of runs
1	30	0.0924	0.0079–0.0346	0.0020–0.0125	20
2	60	0.1005	0.0129–0.0565	0.0021–0.0120	23
3	90	0.1029	0.0136–0.0689	0.0015–0.0121	22
4	120	0.1062	0.0197–0.0725	0.0021–0.0124	20
5	150	0.1075	0.0142–0.0710	0.0012–0.0113	20
6	180	0.1000	0.0242–0.0724	0.0022–0.0109	18

pattern. Nørgaard *et al.* (2000) reported in their study that the performance of complex problems can be improved by using a greater number of hidden layers. ANNs with at least one hidden layer are also known as universal function approximators. Hornik *et al.* (1989) reported that any standard multilayer feed-forward network with a sufficient number of hidden units can approximate any measurable function to any degree of accuracy.

The process of fixing the appropriate weights associated with the connections is known as training (Rumelhart *et al.* 1986) and it is necessary for accurate prediction with ANN models. The training of ANNs is comprised of two steps, namely, the feed-forward step and the back-propagation step.

Feed-forward step

In this step, received information from the input layer is transmitted in the forward direction to the next layer (i.e., the hidden layer). The summation of all incoming inputs at each neuron in the hidden layer can be mathematically expressed as:

$$Net_j = \sum_{i=1}^{n_1} W_{ij}x_i + b_0 \quad (7)$$

where Net_j = input received by the j^{th} neuron of the hidden layer, W_{ij} = associated weight for the connection from the i^{th} neuron of the input layer to the j^{th} neuron of the hidden layer, n_1 = number of neurons in the input layer, b_0 = bias weight and x_i = value of the i^{th} neuron in the input layer.

The input received by the j^{th} neuron of the hidden layer (Net_j) is then transformed using the nonlinear sigmoid activation function to get the output, y_j . The sigmoid function is a widely used activation function for hydrological modeling (Dawson & Wilby 2001). Mathematically, it can be expressed as:

$$y_j = f(Net_j) = \frac{1}{1 + \exp(-\alpha Net_j)} \quad (8)$$

where α is the slope parameter of the sigmoid activation function.

Back-propagation step

In this step, the weights are initialized to start the training and a back-propagation algorithm is used to minimize the total error function. In the minimization process, the total error computed for the training data set at the output layer is back-propagated through the network and, consequently, the associated weights between the connections of the artificial neurons are suitably adjusted. The Levenberg–Marquardt back-propagation algorithm is the most effective and widely used learning technique in the training of artificial neural networks (Hagan & Menhaj 1994). A short description of the working principle of the Levenberg–Marquardt algorithm is given below.

LEVENBERG–MARQUARDT ALGORITHM

The Levenberg–Marquardt algorithm (LM) is used to solve nonlinear least square problems without computing the Hessian matrix (\mathbf{H}). In nonlinear least square problems, \mathbf{H} can be approximated in terms of the Jacobian matrix (\mathbf{J}):

$$\mathbf{H} = \mathbf{J}^T \mathbf{J} \quad (9)$$

$$\mathbf{g} = \mathbf{J}^T \mathbf{e} \quad (10)$$

where \mathbf{e} is the vector of network errors at the output layer and \mathbf{g} is the gradient. \mathbf{J} is the Jacobian matrix which contains the first derivatives of the network errors with respect to the weights and biases. If $e_1, e_2, e_3, \dots, e_N$ are the network errors = $e_i = (C_{d(\text{Actual})} - C_{d(\text{Predicted})})^2$, $w_1, w_2, w_3, \dots, w_n$ are the network weights and $b_1, b_2, b_3, \dots, b_m$ are the network biases then the Jacobian matrix \mathbf{J} can be represented as:

$$\mathbf{J} = \begin{bmatrix} \frac{\partial e_1}{\partial w_1} & \frac{\partial e_1}{\partial w_2} & \dots & \frac{\partial e_1}{\partial w_n} & \frac{\partial e_1}{\partial b_1} & \frac{\partial e_1}{\partial b_2} & \dots & \frac{\partial e_1}{\partial b_m} \\ \frac{\partial e_2}{\partial w_1} & \frac{\partial e_2}{\partial w_2} & \dots & \frac{\partial e_2}{\partial w_n} & \frac{\partial e_2}{\partial b_1} & \frac{\partial e_2}{\partial b_2} & \dots & \frac{\partial e_2}{\partial b_m} \\ \vdots & \vdots & \ddots & \vdots & \vdots & \vdots & \ddots & \vdots \\ \frac{\partial e_N}{\partial w_1} & \frac{\partial e_N}{\partial w_2} & \dots & \frac{\partial e_N}{\partial w_n} & \frac{\partial e_N}{\partial b_1} & \frac{\partial e_N}{\partial b_2} & \dots & \frac{\partial e_N}{\partial b_m} \end{bmatrix}$$

The Levenberg–Marquardt algorithm is a combination of the Gauss–Newton algorithm and gradient descent algorithm. The iterative updating of LM is similar to a Newton-like updating and can be expressed as:

$$\mathbf{x}_{k+1} = \mathbf{x}_k - [\mathbf{J}^T \mathbf{J} + \mu \mathbf{I}]^{-1} \mathbf{g} \quad (11)$$

Equation (11) can be rewritten as:

$$\begin{bmatrix} w_1 \\ w_2 \\ \vdots \\ w_n \\ b_1 \\ b_2 \\ \vdots \\ b_m \end{bmatrix}^{k+1} = \begin{bmatrix} w_1 \\ w_2 \\ \vdots \\ w_n \\ b_1 \\ b_2 \\ \vdots \\ b_m \end{bmatrix}^k - [\mathbf{J}^T \mathbf{J} + \mu \mathbf{I}]^{-1} \mathbf{g}$$

where \mathbf{I} is the identity matrix, μ is a scalar, \mathbf{x}_k and \mathbf{x}_{k+1} are the vectors of independent variables at the k^{th} and $(k+1)^{\text{th}}$ iterations, respectively. Depending upon the values of μ , the LM algorithm interpolates between the Gauss–Newton algorithm and the gradient descent algorithm. The gradient descent algorithm is very good in global convergence while the Gauss–Newton algorithm is excellent in faster local convergence near the minimum. For smaller values of μ , the LM algorithm behaves like the Gauss–Newton algorithm with approximated Hessian matrix. When $\mu = 0$, Equation (11) becomes:

$$\mathbf{x}_{k+1} = \mathbf{x}_k - [\mathbf{J}^T \mathbf{J}]^{-1} \mathbf{g} \quad (12)$$

For larger values of μ , the LM algorithm behaves like the gradient descent algorithm. In the training of ANN models, the LM algorithm starts with larger μ value to ensure global convergence and then quickly shifts towards the Gauss–Newton algorithm for faster local convergence by reducing the μ value after each successful step. The LM algorithm is considered as robust and the fastest converging algorithm for the training of ANN models. A detailed description of the applications of the LM algorithm in neural networks can be found in Hagan *et al.* (1996) and Hagan & Menhaj (1994).

ANN MODEL DEVELOPMENT

The literature suggests that the relationship of discharge as a function of weir height (w), weir length (L) and flow depth (h) is nonlinear in nature. ANN models with one hidden layer are known as universal approximators as they can fit any nonlinear relationship. The universal approximating capability of ANN models has been utilized in this study to estimate the discharge coefficient of a sharp-crested triangular plan form weir. A feed-forward back-propagation ANN model has been developed to estimate the C_d value. Different values of weir heights (w), weir lengths (L) and flow depths (h) are used as input while the corresponding discharge coefficients (C_d) are used as output of the ANN model. This model consists of three neurons in the input layer and one neuron in the output layer. All the input parameters of the ANN model have been non-dimensionalized by dividing them by the channel width (B). A schematic representation of the ANN model is shown in Figure 4.

The performance of the ANN model was evaluated by training this model. Experimental data have been used to train the input–output pattern of the ANN model. The Levenberg–Marquardt algorithm has been used as a back-propagation step in the training of the ANN model. Mean squared error (MSE) has been used as a statistical parameter to quantify the errors in the training of the ANN model. The correlation coefficient (R) has been used to measure the linear dependence between the actual values and their corresponding values predicted by the ANN model. MSE and

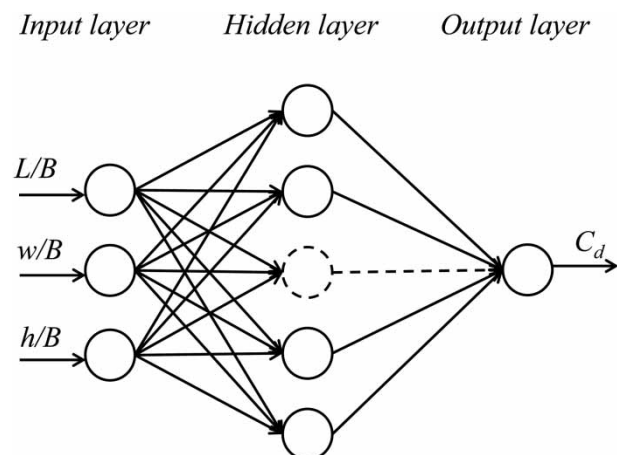

Figure 4 | ANN model.

R can be defined as follows:

$$MSE = \frac{1}{N} \sum_{i=1}^N (C_{dA,i} - C_{dP,i})^2 \quad (13)$$

$$R = \frac{\sum_{i=1}^N (C_{dA,i} - \overline{C_{dA}})(C_{dP,i} - \overline{C_{dP}})}{\sqrt{\sum_{i=1}^N (C_{dA,i} - \overline{C_{dA}})^2} \sqrt{\sum_{i=1}^N (C_{dP,i} - \overline{C_{dP}})^2}} \quad (14)$$

$$W_1 = \begin{bmatrix} -2.1011 & 1.2575 & -2.6393 \\ -0.3742 & 1.3069 & 3.5689 \\ -2.1021 & -2.9915 & -1.6688 \\ -1.8497 & -1.5950 & -2.8382 \\ -1.2195 & -3.3985 & -0.3109 \\ -2.5744 & -2.2070 & -1.6173 \\ -1.1877 & 2.9104 & -2.3817 \\ 3.7593 & -0.5515 & -0.0343 \\ 2.3644 & 0.6359 & 2.5709 \\ 2.6135 & -1.2950 & 2.3480 \\ -1.4122 & 2.1504 & -2.8123 \\ 1.2747 & -2.5318 & -2.5211 \\ 2.5653 & -2.7430 & -1.2904 \\ 0.6904 & 0.5871 & 3.5683 \\ -2.4477 & 1.9316 & -1.5401 \\ 3.3917 & 0.1292 & -1.2823 \\ 2.0768 & 2.5933 & -1.1627 \\ -3.0790 & 0.9411 & -1.3054 \\ -2.3974 & -1.1859 & -2.4963 \\ 1.0346 & 1.4776 & 3.5329 \end{bmatrix} \quad W_2 = \begin{bmatrix} 0.0666 \\ 0.3414 \\ 0.8559 \\ -0.9396 \\ 0.0326 \\ -0.3442 \\ -0.8442 \\ -0.1108 \\ -0.5364 \\ -0.7095 \\ -0.0786 \\ -0.1408 \\ 0.3548 \\ -0.2688 \\ 0.2387 \\ 0.0683 \\ 0.2408 \\ 0.2195 \\ -0.6139 \\ -0.8726 \end{bmatrix} \quad B_1 = \begin{bmatrix} 3.9952 \\ 3.4486 \\ 2.9406 \\ 2.5624 \\ 2.5223 \\ 1.8045 \\ 0.9477 \\ -0.9989 \\ -0.7902 \\ 0.0026 \\ 0.1757 \\ 0.3767 \\ 0.7483 \\ 0.0225 \\ -1.9312 \\ 2.4190 \\ 3.0516 \\ -3.4683 \\ -3.1424 \\ 3.5031 \end{bmatrix}$$

where N = total number of patterns; $C_{dA,i}$ = actual value of i^{th} discharge coefficient; $\overline{C_{dA}}$ = sample mean of actual discharge coefficients; $C_{dP,i}$ = predicted value of i^{th} discharge coefficient; $\overline{C_{dP}}$ = sample mean of predicted discharge coefficients. The MSE obtained after training should be close to 0 and R should be close to 1. In order to evaluate the performance of the ANN model, randomly selected 70%, 15%, and 15% of the total available data have been used respectively in training, testing, and validation of the ANN model. The trial-and-error method has been used to find the optimal number of neurons in the hidden layer of the ANN model. In this method, the mean squared errors (MSE) obtained after training are plotted against the number of hidden neurons which were used in the training.

The number of hidden neurons that gives the minimum mean squared errors (MSE) is chosen as the optimal number of hidden neurons. Using the trial-and-error method, the optimal architecture for the ANN model was found to be 3–20–1.

The weight matrices (W_1 , W_2 , B_1 and B_2) obtained after the training for connections between different layers are given below:

$$B_2 = [0.0272]$$

where B_1 = vector of weights of bias neurons at the hidden layer, W_1 = weight matrix of connections between the neurons of the input and hidden layer, W_2 = weight matrix of connections between the hidden and output layer, B_2 = vector of weights of bias neurons at the output layer.

RESULTS AND DISCUSSION

The performance results of the developed ANN model are shown in Figures 5–10. Values of performance parameters for training, validation and testing of the ANN model are summarized in Table 2. Figures 5–7 represent the regression

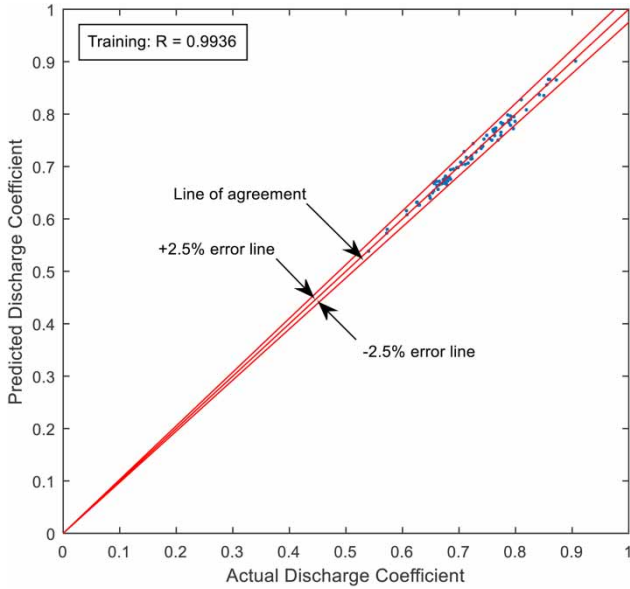

Figure 5 | Regression plot for training of ANN model.

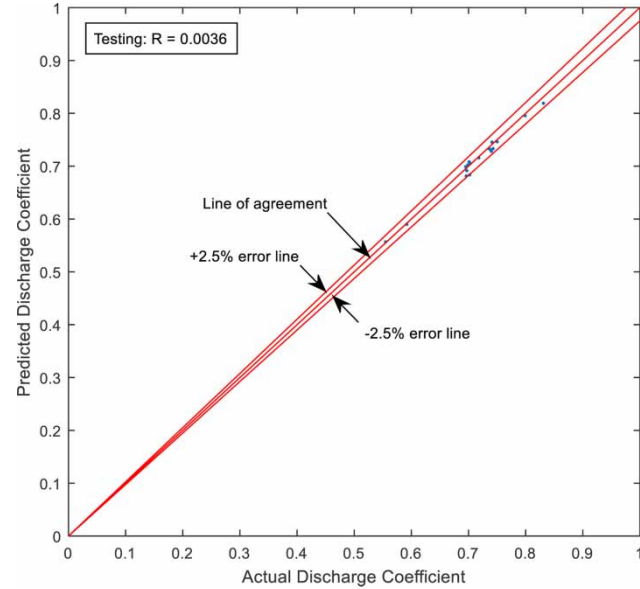

Figure 7 | Regression plot for testing of ANN model.

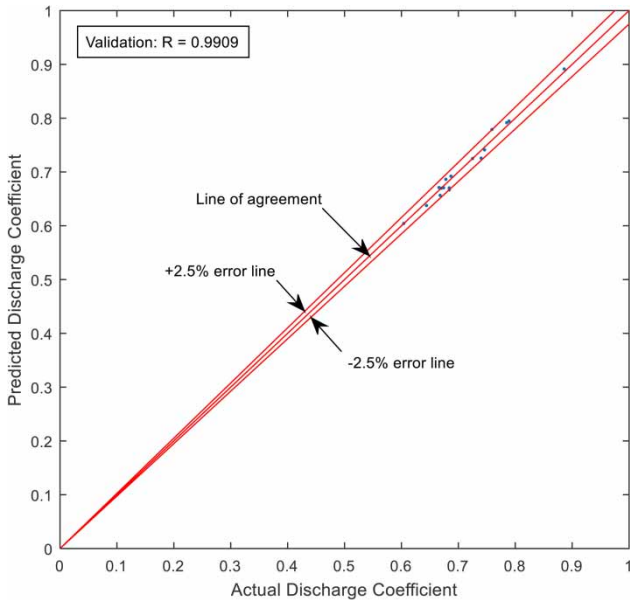

Figure 6 | Regression plot for validation of ANN model.

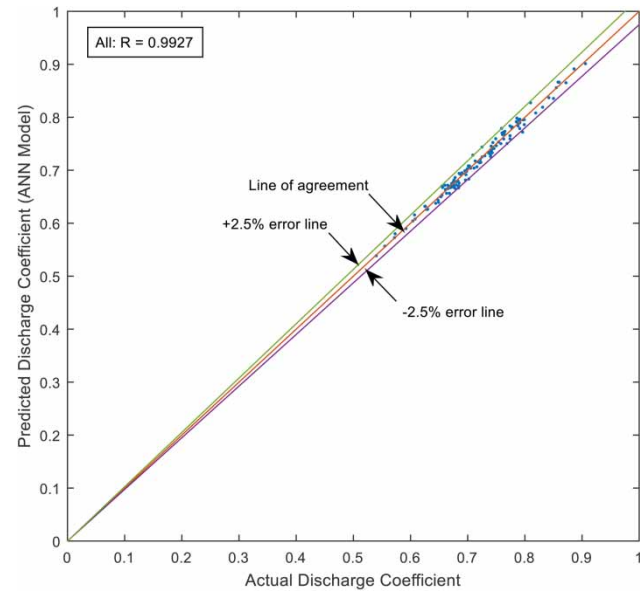

Figure 8 | Regression plot all together (training, validation and testing).

plots for training, validation, and testing of the ANN model. Figure 8 shows the regression plots all together. In these plots, the values of predicted discharge coefficients are plotted against the actual discharge coefficients along with a line of agreement or line of fit. It was observed that the predicted discharge coefficients are quite close to the actual values. Values of the correlation coefficient R for these

regression plots are close to 1. The prediction error in C_d of the ANN model stays within the range of $\pm 2.5\%$. Kumar *et al.* (2011) reported the prediction error for the same experimental data set within the range of $\pm 7\%$. The proposed ANN model reduces the prediction error in C_d by 64%.

Statistical parameters like mean squared error (MSE) and correlation coefficient (R) give only the average values and do

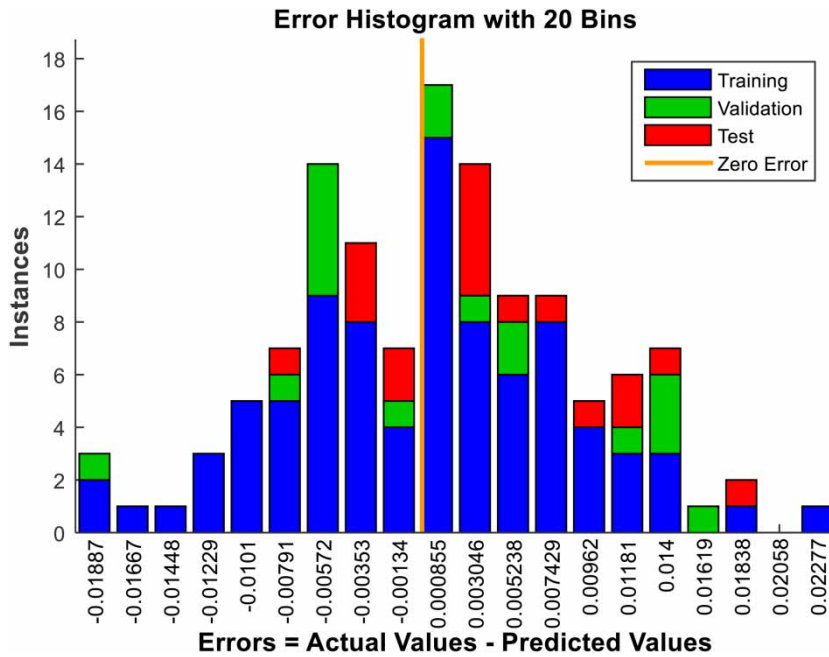

Figure 9 | Plot of error histogram with 20 bins.

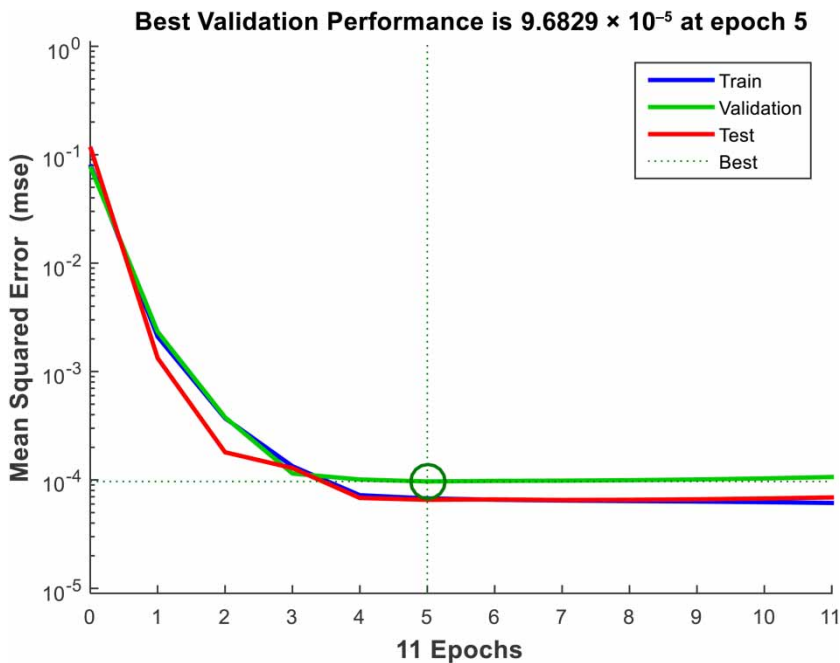

Figure 10 | Plot of MSE with number of epochs.

not provide any information about error distribution. In order to show the error distribution, an error histogram has been used. An error histogram with 20 bins is depicted in Figure 9 to show the error distribution in the predicted discharge

coefficients of the ANN model. From the error histogram, it is quite clear that most of the data points fall into the bins of lesser error ranges. A bell-shape error distribution can be observed in this plot. Mean squared error (MSE) with the

Table 2 | Results of performance parameters for ANN model

Parameters	MSE	R	Data used
Training	6.754×10^{-5}	0.9936	87
Validation	9.682×10^{-5}	0.9909	18
Testing	6.564×10^{-5}	0.9936	18

number of epochs for the ANN model is shown in Figure 10. The best validation performance was obtained at epoch 5 and the corresponding MSE value was found to be equal to 9.6829×10^{-5} . The performance results presented above demonstrate the capability and practical applicability of the proposed ANN model. Furthermore, it can be concluded that the performance of the developed ANN model is reasonably good and therefore can be efficiently utilized to predict the discharge coefficient of the sharp-crested triangular plan form weir.

COMPARISON WITH KUMAR *ET AL.*'S MODEL

Kumar *et al.* (2011) studied the behavior of a sharp-crested triangular plan form weir and proposed the following equation for the coefficient of discharge (C_d):

$$C_d = (-0.065 \theta^3 + 0.318 \theta^2 - 0.537 \theta + 1.190) + (0.090 \theta^3 - 0.570 \theta^2 + 1.460 \theta - 1.670) \frac{h}{w} \quad (15)$$

The above equation is valid only for θ ranging from 30° to 180° and h/w ranging from 0 to 0.7. The scatter plot of actual and predicted discharge coefficients using Kumar *et al.*'s model is shown in Figure 11. It is observed that the prediction error in the discharge coefficient stays within the range of $\pm 7\%$ from the line of agreement. The proposed ANN model reduces the prediction error in C_d by 64%. The results of the ANN model and Kumar *et al.*'s model are compared in Figure 12. The R value using Equation (14) was found to be equal to 0.9617, whereas using the ANN model it is equal to 0.9927. Also, the MSE between the actual and the predicted discharge coefficients using Kumar *et al.*'s approach was found to be equal to 3.695×10^{-4} whereas using the ANN model it is equal to 7.155×10^{-5} . A comparison between the statistical parameters of both the models is summarized in Table 3. Based on the comparison data, it can be concluded

**Figure 11** | Actual versus predicted discharge using the Kumar *et al.* (2011) model.**Figure 12** | Comparison of discharges predicted by the ANN model and Kumar *et al.* (2011) model.

Table 3 | Comparison between Kumar *et al.*'s model and ANN model

Parameters/Model	Kumar <i>et al.</i> (2011)	ANN model
R-value	0.9617	0.9927
MSE	3.695×10^{-4}	7.155×10^{-5}
Prediction error in C_d from the line of agreement	$\pm 7\%$	$\pm 2.5\%$

that the performance of the ANN model is much better than that proposed by Kumar *et al.* (2011).

SENSITIVITY ANALYSIS OF ANN MODEL

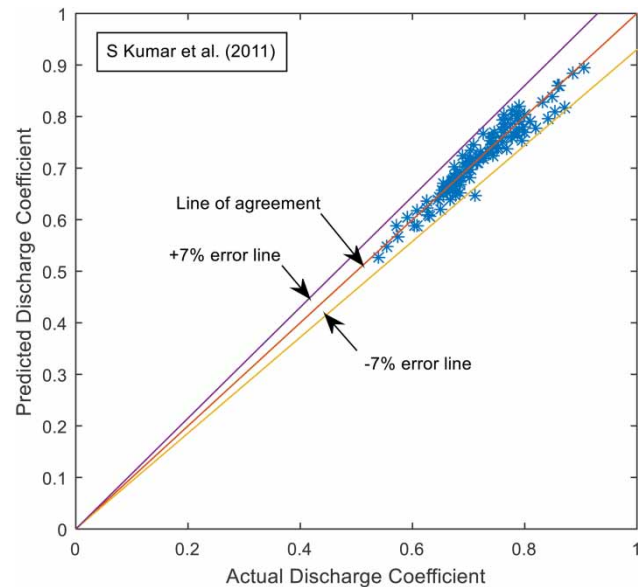
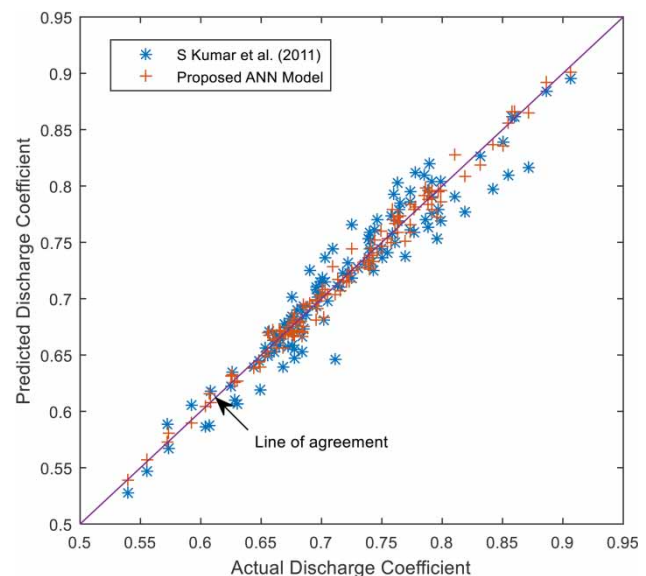
Sensitivity refers to how the output of a neural network is influenced by perturbations in its input parameters. In addition to this, sensitivity is also important in assessing the robustness of an ANN model against noise in the input parameters. In order to know the relative influence of each of the input parameters as well as the robustness of ANN models, sensitivity analysis has been conducted in this study. Perturbations in input parameters are carried out by embedding uniformly

distributed random noise within the range of $\pm 10\%$ of the actual values. The ANN model comprises three input parameters, namely, L , w , and h . In this analysis, only one input parameter has been perturbed at a time. Regression plots of the ANN model for perturbation in the values of weir length (L), weir height (w) and flow depth (h) are shown in Figures 13–15 respectively. The prediction errors in discharge coefficients stay within the ranges of $\pm 9\%$, $\pm 5\%$ and $\pm 3\%$ for perturbations within the range of $\pm 10\%$ in the weir height, flow depth and weir length respectively. Values of performance parameters R and MSE for perturbed responses of the ANN model are summarized in Table 4. Based on these results, it can be concluded that weir height (w) is the most and weir length (L) is the least sensitive

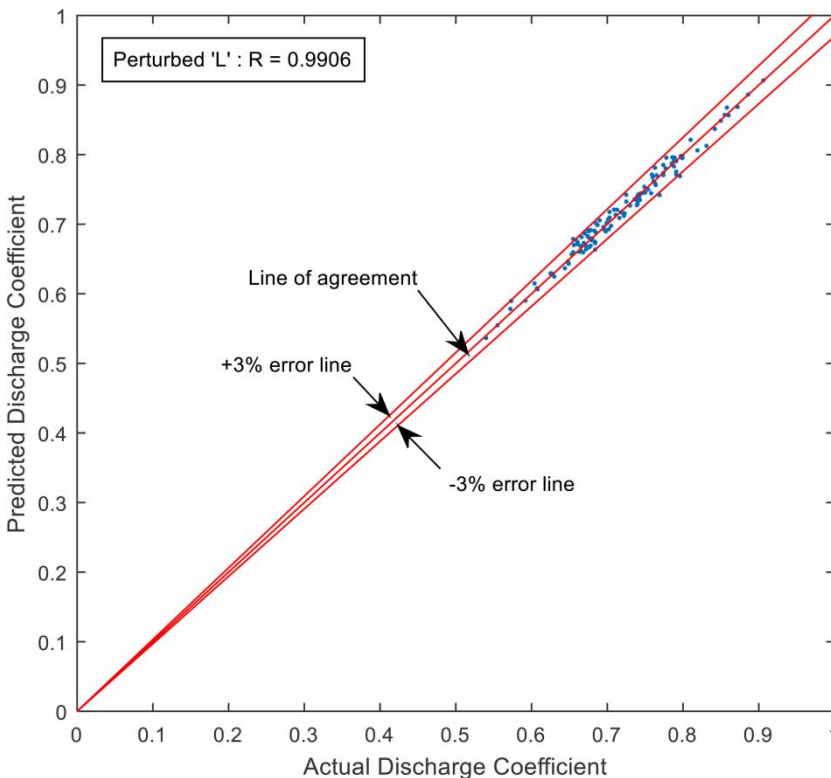
**Figure 13** | Regression plot for perturbed weir length (L).

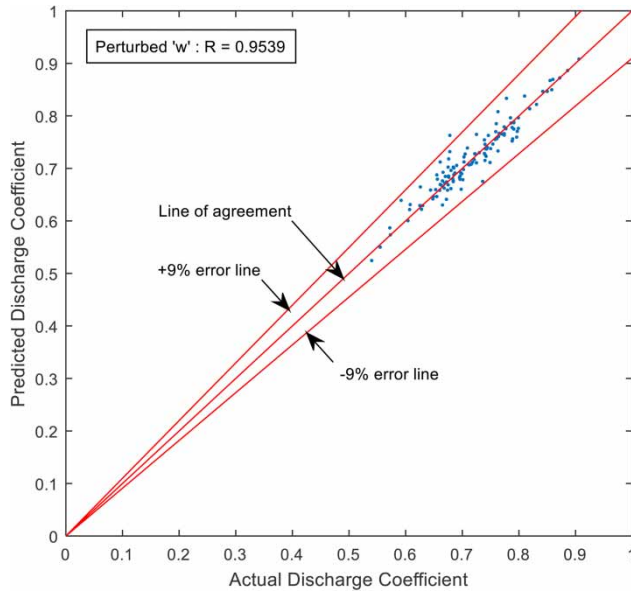

Figure 14 | Regression plot for perturbed weir height (*w*).

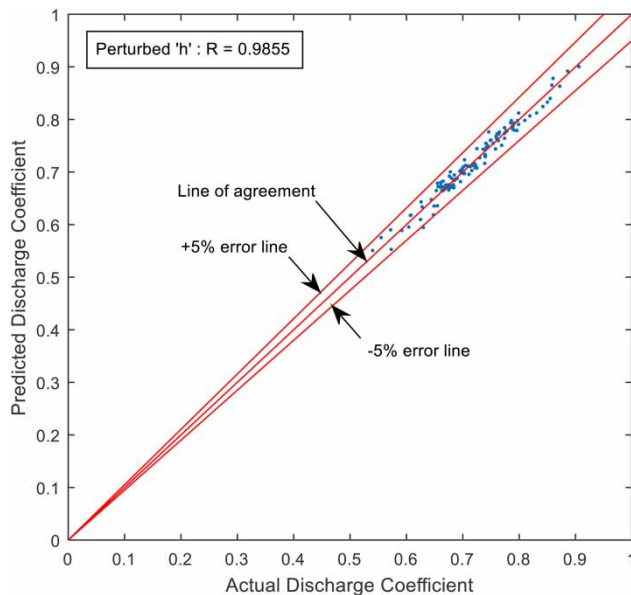

Figure 15 | Regression plot for perturbed flow depth (*h*).

Table 4 | Results of sensitivity analysis for perturbed input parameters (ANN model)

Perturbed parameter	Performance parameter	Training	Validation	Testing
<i>L</i>	MSE	6.371×10^{-5}	1.575×10^{-4}	1.643×10^{-4}
	R	0.9933	0.9862	0.9823
<i>w</i>	MSE	4.242×10^{-4}	4.866×10^{-4}	5.200×10^{-4}
	R	0.9542	0.9665	0.9369
<i>h</i>	MSE	1.267×10^{-4}	1.588×10^{-4}	1.860×10^{-4}
	R	0.9847	0.9871	0.9867

parameter in the developed ANN model. Also, the ANN model appears to be robust even for significantly large perturbations of $\pm 10\%$ in input parameters.

LINKED ANN–OPTIMIZATION MODEL FOR OPTIMAL DESIGN

In this study, a linked ANN–optimization model has been developed to find the optimal values of design parameters of a weir, namely, weir length (*L*), weir height (*w*) and flow depth (*h*) for which the discharge *Q* is maximum. The developed linked ANN–optimization framework is comprised of two models – an optimization model and an ANN model. In the optimization model, an objective function is formulated and then minimized using a constrained nonlinear minimization algorithm. The objective function is formulated in such a way that the minimum of this function will correspond to the maximum discharge. Mathematically, the objective function for the optimization model can be represented as:

$$\text{Minimize: } f = \frac{1}{1 + Q^2} \tag{16}$$

Subject to:

$$q^l \leq q \leq q^u \tag{17}$$

where,

q = vector of weir parameters (*L*, *w* and *h*)

q^l = lower bound on vector *q*

q^u = upper bound on vector *q*.

The discharge *Q* in Equation (16) is a function of *L*, *w*, *h* and *C_d*. In order to calculate *C_d*, the optimization model is

linked externally with the ANN model developed in this study. The ANN model is trained to find the discharge coefficient C_d . The linked ANN–optimization model starts with an initial guess of decision variables L , w and h . This initial guess then serves as an input to the ANN model, which is externally linked with the optimization model. The output of the ANN model is C_d , which then serves as an input to the optimization model along with the other input parameters L , w and h . These input parameters are then used to calculate the discharge Q in order to minimize the objective function mentioned in Equation (16). The optimal values of design parameters L , w and h corresponding to maximum discharge Q are then determined. The flow chart of the linked ANN–optimization model is shown in Figure 16. The plot of objective function with iteration and the resulting optimal values of the design parameters of

weir are shown in Figure 17. The linked ANN–optimization terminates after 23 iterations and the minimum value of the objective function obtained is equal to 0.996504. The corresponding optimal values of design parameters obtained are $L = 1.082$, $w = 0.095$ and $h = 0.073$ with h/w ratio equal to 0.7684. The optimal value of weir length $L = 1.082$ for which the discharge Q is maximum corresponds to the weir angle of 30° . This optimal value of weir length L corresponding to maximum discharge is in agreement with the findings of Kumar *et al.* (2011) in which they reported that the discharge carrying capacity of a triangular plan form weir is increased by increased weir length L .

CONCLUSIONS

The ANN model has been developed in this study to estimate the discharge coefficient of a sharp-crested triangular plan form weir. The performance of the developed ANN model has been evaluated using the Levenberg–Marquardt algorithm and the results were compared with Kumar *et al.*'s model. The developed ANN model shows significant improvement in the estimation of discharge coefficient and reduces the prediction error in C_d by 64%. Also, the sensitivity analysis of the developed ANN model has been carried out by perturbing the input parameters and the weir height was found to be the most sensitive parameter. The ANN model appears to be robust even for a large random error level up to 10% in the input parameters. Furthermore, the linked ANN–optimization model has been developed to find the optimal design parameters of a weir for maximum discharge. Based on the performance results and sensitivity analysis of the developed ANN model, it can be concluded that the ANN model can be efficiently utilized to predict the discharge coefficient of a sharp-crested triangular plan form weir. Also, the linked ANN–optimization model can be utilized for optimal design of a weir for maximum discharge.

CONFLICT OF INTEREST

On behalf of all the authors, the corresponding author states that there is no conflict of interest.

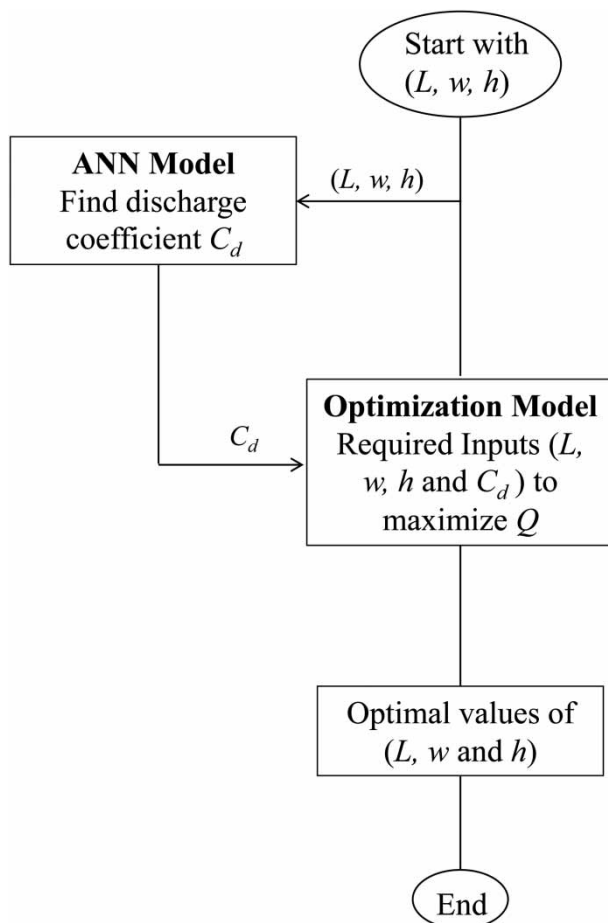

Figure 16 | Flow chart of linked ANN–optimization model.

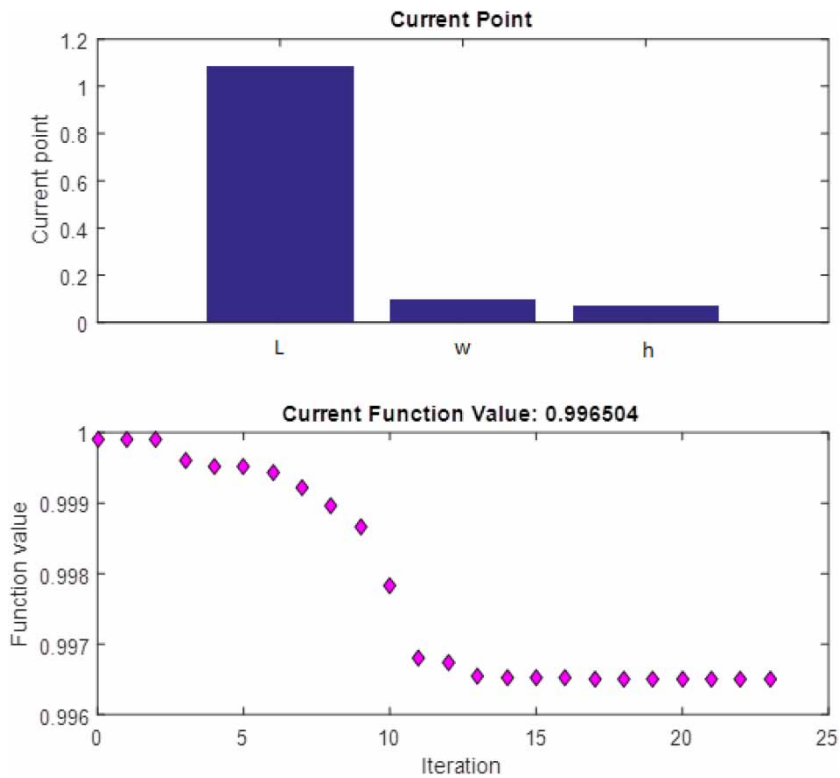

Figure 17 | Plot of objective function with iteration and the optimal values of weir parameters.

DATA AVAILABILITY STATEMENT

All relevant data are included in the paper or its Supplementary Information.

REFERENCES

- Aichel, O. G. 1953 Discharge ratio for oblique weirs. *Zeitschrift des Vereines Deutscher Ingenieure* **95** (1), 26–27 (in German).
- Ayaz, M. & Mansoor, T. 2018 Discharge coefficient of oblique sharp crested weir for free and submerged flow using trained ANN model. *Water Science* **32** (2), 192–212.
- Borghei, S. M., Vatannia, Z., Ghodsian, M. & Jalili, M. R. 2003 Oblique rectangular sharp-crested weir. *Water and Maritime Engineering* **156** (2), 185–191.
- Dawson, C. W. & Wilby, R. L. 2001 Hydrologic modelling using artificial neural networks. *Progress in Physical Geography: Earth and Environment* **25** (1), 80–108.
- Emiroglu, M. E., Kisi, O. & Bilhan, O. 2010 Predicting discharge capacity of triangular labyrinth side weir located on a straight channel by using an adaptive neuro-fuzzy technique. *Advances in Engineering Software* **41** (2), 154–160.
- Ganapathy, K. T., Raj, A. N. & Ramanathan, V. 1964 Discharge characteristics of oblique anicuts. *The New Irrigation Era* **9** (1), 7–12.
- Hagan, M. T. & Menhaj, M. B. 1994 Training feedforward networks with the Marquardt algorithm. *IEEE Transactions on Neural Networks* **5** (6), 989–993.
- Hagan, M. T., Demuth, H. B. & Beale, M. H. 1996 *Neural Network Design*. PWS Publishing, Boston, MA, USA.
- Hay, N. & Taylor, G. 1969 A computer model for the determination of the performance of labyrinth weirs. In: *13th Congress of IAHR*, Kyoto, Japan, pp. 361–378.
- Hay, N. & Taylor, G. 1970 Performance and design of labyrinth weirs. *Journal of the Hydraulics Division* **96** (11), 2337–2357.
- Hornik, K., Stinchcombe, M. & White, H. 1989 Multilayer feed-forward networks are universal approximators. *Neural Networks* **2**, 359–366.
- Kandaswamy, P. K. & Rouse, H. 1957 Characteristics of flow over terminal weirs and sills. *Journal of the Hydraulics Division* **83** (4), 1345.
- King, H. W., Nagler, F. A., Streiff, A., Parshall, R. L., Pardoe, W. S., Ballester, R. E., Williams, G. S., Rehbock, T., Lindquist, E. G. W. & Herschel, C. 1929 Discussion of 'Precise weir

- measurements' by Schoder, E. W. and Turner, K. B. *Trans. ASCE* **95** (1), 1143–1162.
- Kumar, S., Ahmad, Z. & Mansoor, T. 2011 [A new approach to improve the discharging capacity of sharp-crested triangular plan form weirs](#). *Flow Measurement and Instrumentation* **22**, 175–180.
- Nørgaard, M., Ravn, O., Poulsen, N. K. & Hansen, L. K. 2000 *Neural Networks for Modelling and Control of Dynamic Systems*. Springer-Verlag, London, UK.
- Rumelhart, D. E., Hinton, G. E. & Williams, R. J. 1986 Learning internal representations by error propagation. In: *Parallel Distributed Processing, Volume 1* (D. E. Rumelhart, J. L. McClelland & PDP Research Group, eds). MIT Press, Cambridge, MA, USA, pp. 318–362.
- Schalkoff, R. J. 1997 *Artificial Neural Networks*. McGraw-Hill, New York, USA.
- Swamee, P. K. 1988 [Generalized rectangular weir equations](#). *Journal of Hydraulic Engineering* **114** (8), 945–949.
- Swamee, P. K., Ojha, C. S. P. & Mansoor, T. 2011 [Discharge characteristics of skew weirs](#). *Journal of Hydraulic Research* **49** (6), 818–820.
- Taylor, G. 1968 *The Performance of Labyrinth Weirs*. PhD thesis, University of Nottingham, Nottingham, UK.
- Tullis, B. P., Young, J. C. & Chandler, M. A. 2007 [Head-discharge relationships for submerged labyrinth weirs](#). *ASCE Journal of Hydraulic Engineering* **133** (5), 248–254.
- Tuyen, N. B. 2006 *Flow over Oblique Weirs*. MSc thesis, Delft University of Technology, Delft, The Netherlands.
- Wormleaton, P. R. & Soufiani, E. 1998 [Aeration performance of triangular planform labyrinth weirs](#). *ASCE Journal of Environmental Engineering* **124** (8), 709–719.
- Wormleaton, P. R. & Tsang, C. C. 2000 [Aeration performance of rectangular planform labyrinth weirs](#). *ASCE Journal of Environmental Engineering* **126** (5), 456–465.
- Zurada, J. M. 1990 *Introduction to Artificial Neural Systems*. Jaico Publishing House, Mumbai, India.

First received 1 December 2020; accepted in revised form 28 February 2021. Available online 12 March 2021