

Sequence Variation in the Herpes Simplex Virus U_S1 Ocular Virulence Determinant

Aaron W. Kolb,¹ Timothy R. Schmidt,^{2,3,4} David W. Dyer,^{2,3} and Curtis R. Brandt^{1,5}

PURPOSE. The herpes simplex virus type 1 (HSV-1) U_S1 gene encodes host-range and ocular virulence determinants. Mutations in U_S1 affecting virulence are known in strain OD4, but the genomic variation across several strains is not known. The goal was to determine the degree of sequence variation in the gene from several ocular HSV isolates.

METHODS. The U_S1 gene from six ocular HSV-1 isolates, as well as strains KOS and F, were sequenced, and bioinformatics analyses were applied to the data.

RESULTS. Strains 17, F, CJ394, and CJ311 had identical amino acid sequences. With the other strains, most of the variability was concentrated in the amino-terminal third of the protein. MEME analysis identified a 63-residue core sequence (motif 1) present in all α -herpesvirus U_S1 homologs that were located in a region identified as structured. Ten amino acids were absolutely conserved in all the α -herpesvirus U_S1 homologs and were all located in the central core. Consensus-binding motifs for cyclin-dependent kinases and pocket proteins were also identified.

CONCLUSIONS. These results suggest that significant sequence variation exists in the U_S1 gene, that the α 22 protein contains a conserved central core region with structurally variable regions at the amino- and carboxyl termini, that 10 amino acids are conserved in α -herpes U_S1 homologs, and that additional host proteins may interact with the HSV-1 U_S1 and U_S1.5 proteins. This information will be valuable in designing further studies on structure-function relationships and on the role these play in host-range determination and keratitis. (*Invest Ophthalmol Vis Sci.* 2011;52:4630–4638) DOI:10.1167/iovs.10-7032

Herpes simplex virus type 1 (HSV-1) is a significant human pathogen causing diseases such as mucocutaneous ulcers, keratitis, and encephalitis. In the United States, HSV-1 is the

leading cause of blindness from infection and the leading cause of sporadic encephalitis.^{1,2} Studies in animal models have shown that the severity of an HSV-1 infection depends on three factors. The first is the innate resistance of the host. Strains of mice vary widely in their susceptibility, and some host genes involved in this innate immune resistance have been identified.^{3–8} The second factor is the host's acquired immune response. Animals with various defects in acquired immunity have difficulty in controlling viruses, resulting in lethal infections.^{9–14} The host immune response is crucial because corneal damage results from an immunopathological response.^{15–17}

The third factor is the genetic makeup of the virus. Strains of HSV-1 display virulence patterns ranging from no disease to lethal encephalitis (see Refs. 18, 19 for review). The severity of keratitis also varies widely between strains. Although the sequence of one complete HSV-1 genome has been available for some time^{20–23} and two more genomes were recently sequenced,²⁴ little is known about the total sequence divergence and the role most HSV-1 genes play in the severity of an infection. Deletion of certain genes from the virus can have significant effects on virulence, but in nature it is more likely that virulence differences are due to effects of multiple genes and the combination of alleles carried by a given strain of virus. This is supported by a study showing that transferring different combinations of genes from a moderately virulent strain (CJ394) into a highly attenuated strain of virus (OD4)^{25,26} resulted in different virulence patterns in mice. At least seven genes were shown to be involved in the virulence differences. One gene that, when transferred from CJ394 into OD4, increased ocular virulence but not neurovirulence was U_S1, and two sequence changes, S34A and Y116C, that must occur together, were suggested to play a role in the difference in virulence.^{25,26}

The HSV-1 U_S1 protein (α 22) is an immediate early (α) gene that regulates several processes in infected cells. In concert with the U_S3 and U_L13 kinases, it alters the phosphorylation of RNA polymerase II, and this is thought to target Pol II to the viral genome.^{27–31} The α 22 protein is also responsible for the efficient expression of some late genes, including U_L41, U_S11, U_L47, U_L49, U_L13, and U_L4.^{32–36} In addition, it plays a role in determining the composition of virions, possibly through effects on late gene expression,³⁷ and negatively regulates α -gene expression.^{38,39} The α 22 protein has also been reported to block B-cell activation of CD4⁺ T cells.⁴⁰ The activities of the α 22 protein are mediated by interactions with both viral and host proteins.^{27,32,41–46} The α 22 protein is also heavily posttranslationally modified by serine and tyrosine phosphorylation, guanylylation, and adenylation, and multiple isoforms (at least seven or eight) are found in infected cells.^{25,36,47–52} The functions of each of the isoforms in infection and virulence are not understood.

In addition to the 420-amino acid α 22 protein, a second protein, U_S1.5, is expressed from the U_S1 gene.⁵³ The U_S1.5

From the Department of ¹Ophthalmology and Visual Sciences and ⁵Medical Microbiology and Immunology, University of Wisconsin School of Medicine and Public Health, Madison, Wisconsin; and the ²Department of Microbiology and Immunology and ³Laboratory for Genomics and Bioinformatics, Oklahoma University Health Sciences Center, Oklahoma City, Oklahoma.

⁴Deceased February 11, 2011.

Supported by National Institutes of Health Grants EY07336 (CRB), P30 EY016665, and P2PRR016478 (DWD); National Center for Research Resources Grant P20 RR-015564 (DWD); a Research to Prevent Blindness Senior Scientist Award (CRB); and an unrestricted grant from Research to Prevent Blindness, Inc. to the Department of Ophthalmology and Visual Sciences.

Submitted for publication December 10, 2010; revised March 10 and 31, 2011; accepted April 14, 2011.

Disclosure: **A.W. Kolb**, None; **T.R. Schmidt**, None; **D.W. Dyer**, None; **C.R. Brandt**, None

Corresponding author: Curtis R. Brandt, Departments of Ophthalmology and Visual Sciences, University of Wisconsin School of Medicine and Public Health, 3395A Medical Sciences Center, 1300 University Avenue, Madison, WI 53706; crbrandt@wisc.edu.

TABLE 1. Herpesvirus Species Names, Gene Designations, and Accession Numbers

Virus Species	Virus Name Abbreviation	Strain	U _s 1 Gene Homolog Designation	Accession No. (reference)
<i>Alphaherpesvirinae</i>				
<i>Simplexvirus</i>				
HSV-1	HSV-1	OD4	U _s 1	JF511471
HSV-1	HSV-1	994	U _s 1	JF511474
HSV-1	HSV-1	CJ394	U _s 1	JF511469
HSV-1	HSV-1	TFT401	U _s 1	JF511475
HSV-1	HSV-1	CJ311	U _s 1	JF511470
HSV-1	HSV-1	CJ970	U _s 1	JF511472
HSV-1	HSV-1	KOS	U _s 1	JF511473
HSV-1	HSV-1	Strain F	U _s 1	GU734771.1*
HSV-1	HSV-1	Strain 17	U _s 1	2703435†
HSV-1	HSV-1	HF10	U _s 1	DQ889502*
HSV-1	HSV-1	R-15	ORF_07R	AY344654*
HSV-2	HSV-2	HG52	U _s 1	1487350†
Cercopithecine herpesvirus 2	SAS	B264	U _s 1	3190318†
<i>Mardivirus</i>				
Gallid herpesvirus 2	GaHV-2	Md5	MDV088	4811543†
<i>Varicellovirus</i>				
Human herpesvirus 3	VZV	03-500	ORF63	ABF21862
Independent branch				
Duck enteritis virus	DEV	DEV Clone-03	U _s 1	EF524095

* Gene ID not available.

† Gene ID references.

protein is translated in the same reading frame as the α 22 protein but is truncated at the *n*-terminus. Translation start sites for U_s1.5 have been reported at residues 171,⁵² 147,⁵³ and 90.⁵⁴ The reason for the difference is not clear but may be due to the use of different strains of virus (F and KOS) in these studies. The U_s1.5 protein is found only at late times, and the levels are upregulated by the U_s3 kinase and downregulated by the U_L13 kinase.⁵⁵ The distinct or shared functions of α 22 and U_s1.5 are not completely understood, but the U_s1.5 protein appears to downregulate cyclin expression in infected cells.⁴⁶ The U_s1.5 protein has a diffuse cytoplasmic location whereas the α 22 protein appears as punctate nuclear spots,^{32,44,56-58} but how this correlates with the functions of the two proteins is not clear.

Studies on the role of the HSV-1 U_s1 gene in virulence are hampered by a lack of knowledge of the degree of sequence variability between strains. To address these deficiencies, we sequenced the U_s1 gene from eight HSV-1 strains and applied a bioinformatics analysis of the sequence data. The results show that there is significant sequence heterogeneity between the U_s1 genes concentrated primarily in the amino-terminal third of the protein. In addition, we identified a 63-amino acid motif in the center of the protein, determined that 10 amino acid residues are absolutely conserved in all α -herpesvirus U_s1 homologs, and identified putative binding motifs for host proteins. These data provide information critical for designing mutagenesis strategies that can be used to study the structure and function of the α 22 protein and the role it plays in virulence and host range.

MATERIALS AND METHODS

Cell Culture and Viruses

Vero cells were cultured in Dulbecco's modified Eagle's medium with 5% serum and antibiotics, as described previously.⁵⁹ The viral sequences analyzed in this study are listed in Table 1. The ocular virulence characteristics of HSV-1 strains OD4, CJ311, CJ394, 994, 970, TFT401, and KOS were described previously.^{59,60} Briefly, HSV-1 strain

OD4 is avirulent with multiple attenuating mutations.^{25,59,60} Strain CJ994 causes mild stromal keratitis. Viral strains CJ394 and TFT401 cause moderate stromal keratitis. HSV-1 KOS produces moderately severe keratitis, with <20% mortality in 5- to 6-week-old mice. Mice infected with strain CJ311 exhibit severe blepharitis, and 70% of the mice die of encephalitis before stromal keratitis develops. Strain CJ970 causes severe stromal disease and 50% mortality. Strain F is a commonly used laboratory strain and is neurovirulent after peripheral inoculation.⁶¹

Viral DNA Isolation

Viral DNA was isolated using a modification of a previously described large-scale preparation.⁶² Briefly, 10 confluent 10-cm plates of Vero cells were infected at a multiplicity of infection of 1.0. The plates were scraped 24 hours after they reached 100% cytopathic effect, and the cells were pelleted at 2000g for 10 minutes at 4°C. The cell pellet was resuspended in 5 mL of medium, subjected to three freeze-thaw cycles (-80°C/37°C), and centrifuged at 2000g to remove debris. The supernatants were then combined, layered onto a 36% sucrose cushion in reticulocyte standard buffer (RSB; 10 mM Tris, pH 7.4, 10 mM NaCl, 3 mM MgCl₂), and then centrifuged for 80 minutes at 13,500 rpm in a rotor (Beckman SW28; Beckman-Coulter Inc., Brea, CA). The viral pellet was resuspended in 5 mL TE buffer (10 mM Tris, pH 7.4, 1 mM EDTA) with 0.15 M sodium acetate and 50 μ g/mL RNase A and was incubated 30 minutes at 37°C. Proteinase

TABLE 2. Catalog of Primers Used for Direct Sequencing of the U_s1 Gene Amplicons

Forward or Reverse Primer	Genome Nucleotide Location	Primer Sequence
Forward	132, 363	5' TTTTGCACGGGTAAGCAC 3'
Forward	132, 782	5' CAGCCTTGGAGTCTCGAGGTCG 3'
Forward	133, 141	5' AAGCCCAATGCAATGCTAC 3'
Forward	133, 464	5' GCAAGCTTCCTTGTGGAG 3'
Reverse	133, 006	5' TGGGGGAATGTCGTATAAGA 3'
Reverse	133, 245	5' ACCCGAAACAGCTGATTGAT 3'
Reverse	133, 716	5' GTCCAGTCAAACCTCCGAAA 3'
Reverse	133, 992	5' CCGACTTCCTCACATCTGCT 3'

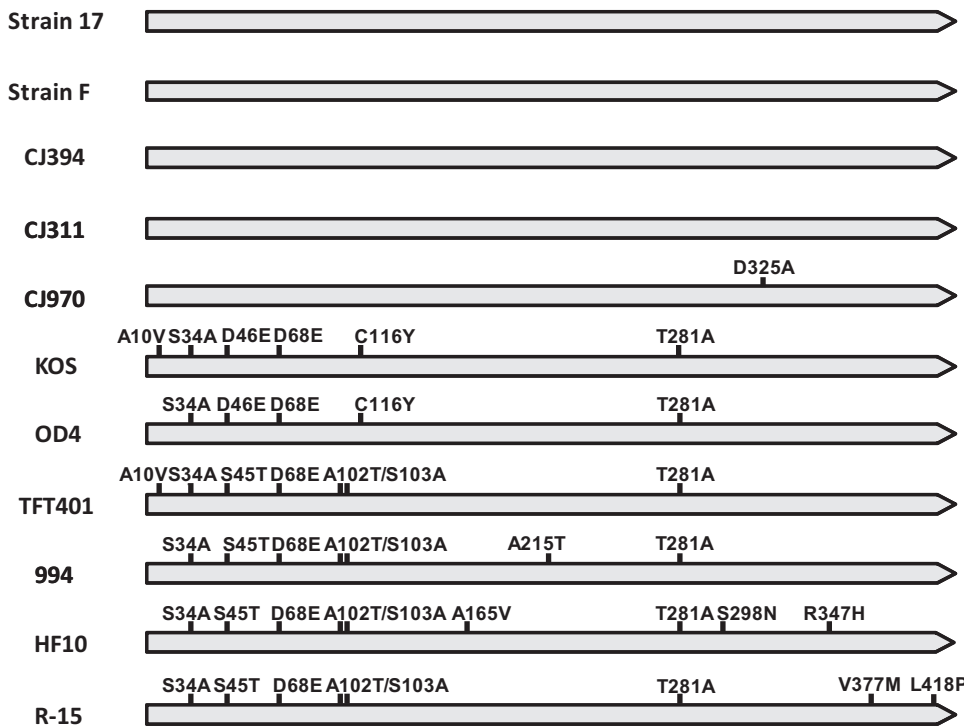

FIGURE 1. Sequence variability in the HSV-1 U_s1 (α 22) protein. *Filled arrows*: U_s1 protein for each strain of virus, with amino acid differences indicated by *vertical bars* with the sequence differences noted. Only the amino acids different from the strain 17 sequence are shown.

K and SDS (50 μ g/mL and 0.1% respectively) were then added, and the solution was incubated for 30 minutes at 37°C. The viral DNA was then purified by phenol/chloroform extraction and ethanol precipitation, re-suspended in deionized water, and stored at -20°C.

Sequencing the U_s1 Gene from Multiple Strains

To obtain the U_s1 sequence from strains F, KOS, OD4, CJ394, TFT401, CJ311, 970, and 994, the U_s1 gene was amplified from purified viral genomic DNA and then directly sequenced. To amplify the U_s1 gene, we performed a PCR reaction consisting of 2.5 μ g viral DNA, 1 \times reaction buffer, 1 \times enhancer buffer, 1 mM MgSO₄, 4 mM dNTP, 0.1 μ g each primer, and 1 μ L Pfx high-fidelity polymerase (Invitrogen Inc., Carlsbad, CA) in a total volume of 50 μ L. The cycling conditions were 1 cycle of 94°C for 5 minutes, 30 cycles of 94°C for 15 seconds, 50°C for 30 seconds, 68°C for 2 minutes, and a final cycle of 58°C for 7 minutes. The U_s1 gene extends between genome nucleotides 132,363 and 133,906. The forward primer annealed at nucleotide 132,363 (5'-TTTGCACGGGTAAGCAC-3'), and the reverse primer annealed at nucleotide 133,992 (5'-CCGACTTCCTCACATCTGCT-3'). The PCR products were directly sequenced using multiple primers (Table 2). The sequencing mixture consisted of 200 μ g amplification product, 1 \times reaction buffer, 0.1 μ g primer, and 2 μ L dye terminator (Big Dye, v3.1; Applied Biosystems, Foster City, CA) in a total volume of 20 μ L. The cycling conditions were 1 cycle of 95°C for 3 minutes, 45 cycles of 95°C for 20 seconds, 45°C for 30 seconds, and 60°C for 4 minutes followed by a final cycle of 72°C for 7 minutes. Sequences were determined at the University of Wisconsin-Madison Biotechnology Cen-

ter sequencing facility. To reconcile discrepancies in the sequence, chromatograms were visually inspected or sequencing reactions were repeated. The constructs were sequenced and found to match the sequences of the original strains.

Sequence Analysis

The sequences used for analysis were derived from this work and from sequences available in GenBank, as shown in Table 1. The nucleotide and amino acid sequences were aligned with ClustalW⁶³ assuming no gaps. Phylogenetic analyses were performed with the Molecular Evolutionary Genetics Analysis package (MEGA4⁶⁴). The nucleotide-based bootstrap consensus tree was constructed using the neighbor-joining algorithm⁶⁵ and the Kimura 2-parameter method⁶⁶ and was derived from 1000 replicates.⁶⁷ The bootstrap consensus tree constructed with amino acid sequence data was generated using the neighbor-joining algorithm and the JTT matrix-based method⁶⁸ derived from 1000 replicates. Analysis with minimum evolution (ME) and maximum-parsimony methods produced similar results. Multiple EM for Motif Elicitation (MEME,⁶⁹) analysis used the zoops (zero or one motif) algorithm to determine the presence and absence of motifs in the target sequences. The number of motifs ($n = 10$) reported was limited to motifs that had the potential to be phylogenetically informative. The optimum motif width specified in analysis ranged from 35 to 80, and the optimum number of sites for each motif varied from 2 to 50. Motifs revealed in the summary MEME analysis were conservatively excluded to limit the number of false-positive motif placements. The ratio of synonymous to non-synonymous substitutions for the HSV-1 U_s1 sequences was per-

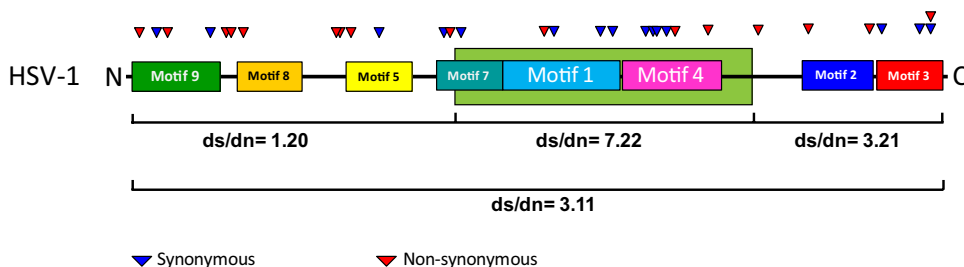

FIGURE 2. Diagram plotting both synonymous and non-synonymous substitutions along the length of the HSV-1 α 22 protein. The ratio of synonymous to non-synonymous substitutions was determined for both the whole protein and the major segments.

formed using SNAP (<http://www.hiv.lanl.gov/content/sequence/SNAP/SNAP.html>⁷⁰).

Protein Folding and Structural Feature Prediction

Identification of putative folded globular regions of the α 22 protein was performed using Globplot2 (<http://globplot.embl.de>⁷¹). Short functional site prediction using the Strain 17 sequence was performed using ELM (<http://elm.eu.org>⁷²).

RESULTS

The U_s1 genes from six independent low-passage ocular isolates of HSV-1 and the laboratory strains KOS and F were

sequenced. The U_s1 sequence from our strain F matched the recently deposited strain F, and we refer to that accession number. This information was combined for analysis with available sequence data for strain 17 and other α -herpesvirus U_s1 homologs, as shown in Table 1.

Sequence Divergence between HSV-1 U_s1 Genes

A schematic diagram summarizing the amino acid sequence differences between all of the 11 HSV-1 U_s1 genes available for analysis is shown in Figure 1. Four strains—17, F, CJ394, and CJ311—had identical U_s1 sequences. Strain CJ970 differed from the strain 17 group by only one amino acid

A Amino Acid Based N-J Tree

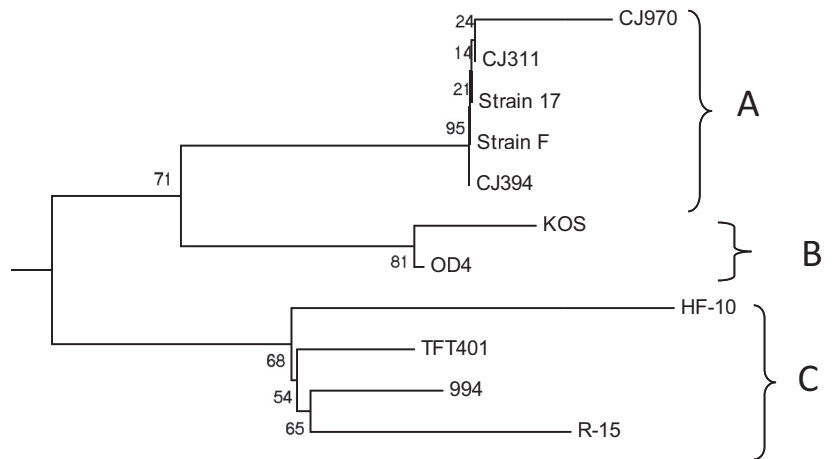

B Nucleotide Based N-J Tree

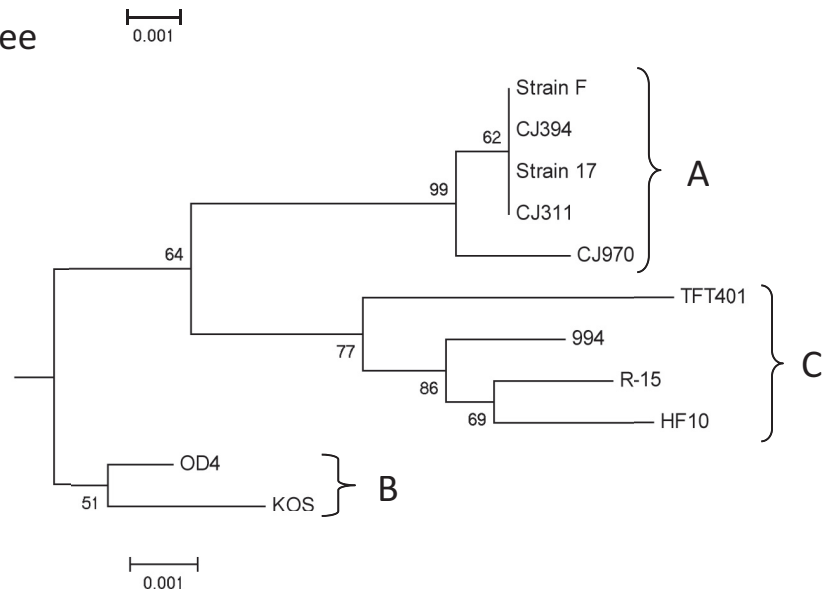

FIGURE 3. Phylogenetic relationships among U_s1 sequences of HSV strains. (A) Neighbor-joining tree based on amino acid sequence data. (B) Neighbor-joining tree generated with nucleotide sequence data. Each tree was generated using 1000 bootstrap replicates. The sequence of the HSV-2 strain HG52 U_s1 gene was used as the outgroup, but only the HSV-1 strains are shown. The three clades are denoted A, B, and C. The branch lengths are proportionate to the amount of evolutionary change and the scale to either nucleotide or amino acid replacement per position, respectively. The sequences of strains CJ970, CJ311, CJ394, F, KOS, OD4, TFT401, and 994 were generated for this study. All the HSV-1 strains, except F and KOS, are low-passage clinical isolates obtained from the Seattle, Washington, area. All other sequences were obtained from the NCBI GenBank database (Table 1).

(D325A). The remainder of the strains had between 5 and 9 amino acid differences compared with strain 17. These results and others shown suggest that U_s1 has a central conserved core and that most of the variability occurs in the amino-terminal third of the protein. To confirm this, we compared the ratio of synonymous to non-synonymous mutations. As shown in Figure 2, the central core clearly had the highest ratio ($ds/dn = 7.22$), the carboxyl-terminal third was conserved but less so ($ds/dn = 3.21$), and the amino-terminal third had a ratio near 1 ($ds/dn = 1.2$).

Phylogenetic Analysis of U_s1 Genes

Figure 3A shows the neighbor-joining tree for the HSV-1 U_s1 amino acid sequences using HSV-2 strain HG52 as the out group. Similar results were obtained using maximum-parsimony and maximum-likelihood methods, indicating the tree was robust. The maximum sequence divergence between the HSV-1 strains was 1.2%, and the HSV-1 strains clearly separated into three distinct groups or clades. The three-clade structure was seen previously, but the clades based on the U_s1 gene differ.^{73,74} Group A included strains 17, CJ970, CJ394, CJ311, and F. Only two strains (KOS and OD4) were in group B, and four strains (HF10, TFT401, 994, and R-15) were in group C. As shown in Figure 3B, the phylogenetic analysis based on the nucleotide sequences yielded the same three clade structures of amino acid sequences, although the topology of the tree was slightly different.

MEME Analysis for Conserved Motifs

MEME analysis, which identifies statistically significant motifs in a data set, was used to identify 10 phylogenetically informative amino acid sequence motifs (Figs. 4, 5). A core motif (motif 1) was identified in all α -herpesvirus U_s1 genes and their homologs and is, thus, distinctive for all α -herpesviruses. This motif had the lowest expectation value (2×10^{-56}) and was, therefore, highly statistically significant. The three reported start sites for the U_s1.5 protein lie in motifs 5, 7, and 8.⁵²⁻⁵⁴ Motifs 5 and 9 each contain one of the nuclear localization signals, and motif 8 contains a putative nucleotidylation site.⁴⁹ The consensus tyrosine phosphorylation site⁵¹ (Y193) mapped to motif 1. In the Old World simian virus group (e.g., SA8), only motifs 1, 2, 3, 5, and 8 were conserved; thus, MEME analysis can clearly be used to distinguish simian α -herpesviruses from human viruses. The avian and varicellovirus groups are characterized by the presence of motif 6. The presence of motif 10 was variable; it was present in GaHV-2 and VZV but not in the duck enteritis virus.

When the GlobPlot2 program was used to examine potential folding of the HSV-1 strain 17 U_s1 protein (Fig. 5), we found that only the central portion of the protein could be folded into a putative globular domain. This region overlapped motif 1 in all the α -herpesvirus α 22 proteins. These results are consistent with the central portion of the α 22 protein as a core conserved region.

DISCUSSION

The HSV-1 U_s1 gene encodes an immediate early (α) protein that carries out a number of functions in infected cells and is clearly a host range virulence determinant.^{25,26,34,75-77} We previously identified two sequence changes in the α 22 protein of the avirulent strains OD4, S34A, and Y116C^{25,26,59} that, when reverted to wild type, conferred the ability to cause severe keratitis in a mouse model. At that time, only the strain 17 sequence was available for comparison. In this study, we sequenced the U_s1 gene from six low-passage ocular HSV-1 isolates as well as KOS and F and used these new sequence data

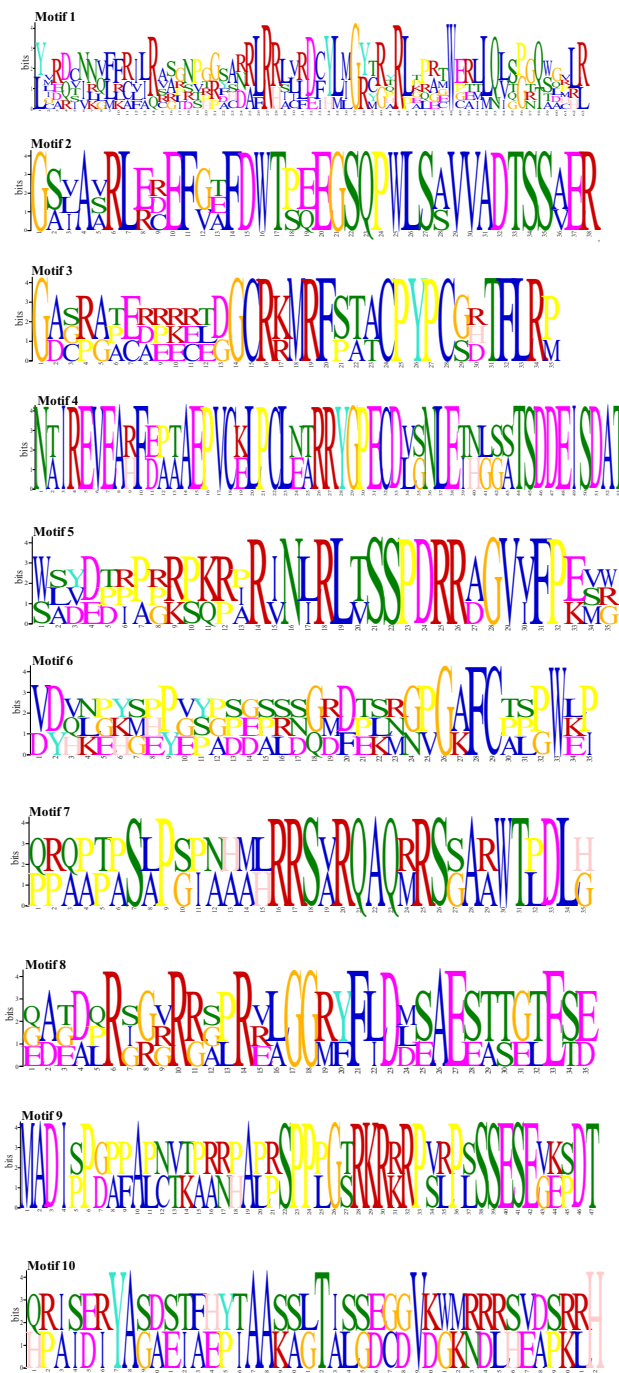

FIGURE 4. MEME analysis for conserved motifs within the α -herpesvirus α 22 protein. Motif detection was limited to a phylogenetically relevant $n = 10$. The sequence of each of the motifs is presented; the larger the letter, the greater the conservation.

to carry out a bioinformatic analysis and to determine the sequence variability in the α -herpesvirus U_s1 homologs. When we analyzed the amino acid sequence variability in the HSV-1 α 22 protein, we found several differences between the strains. Sequence variability was highest in the amino-terminal third of the protein. Multiple functions have been mapped to the carboxyl-terminal portion, including modification of Pol II.^{46,57} Thus, the clustering of several functions in the carboxyl-terminal half of the protein may account for the sequence conservation in this region.

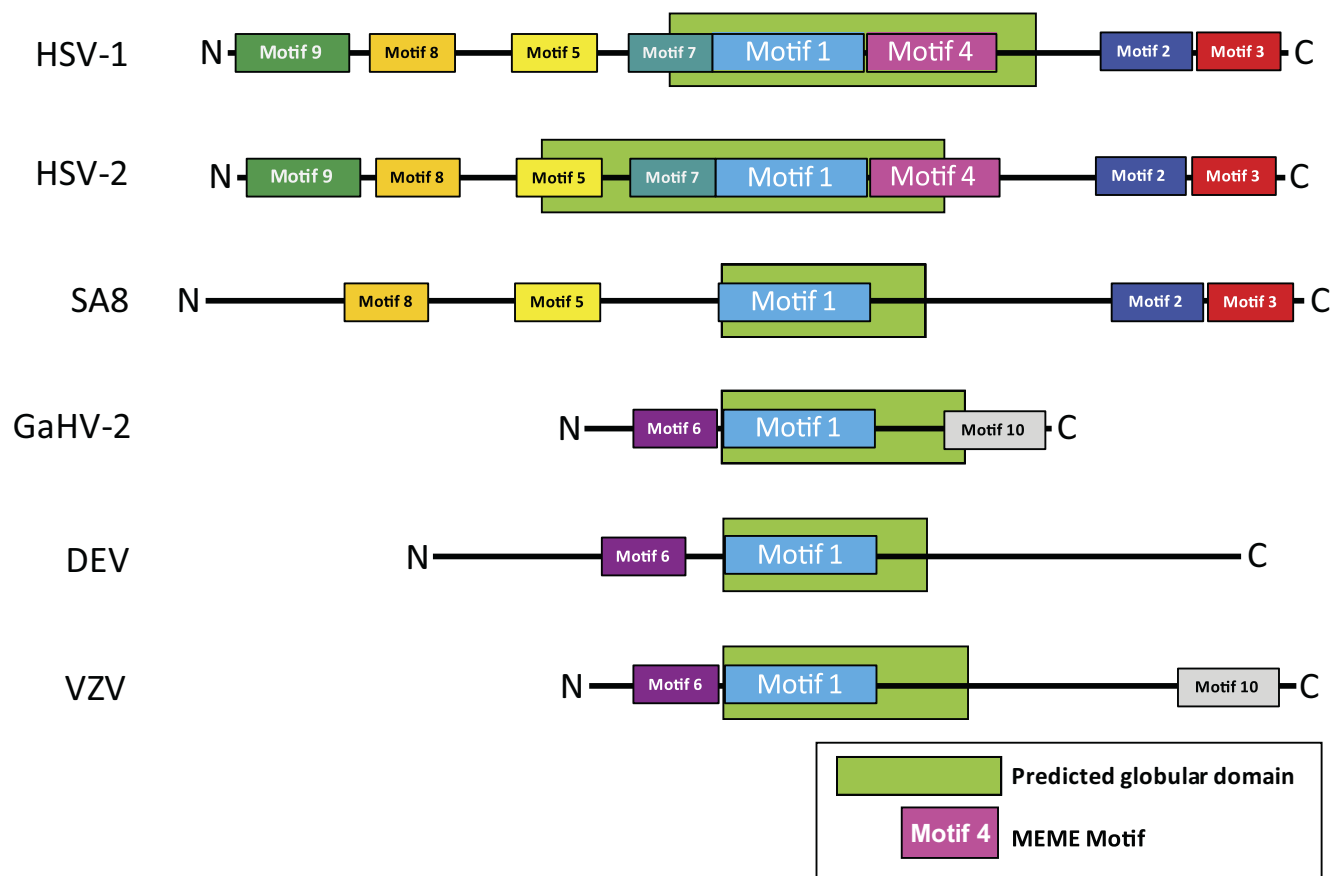

FIGURE 5. Map of MEME analysis for conserved motifs in the α -herpesvirus $\alpha 22$ protein. The motifs are numbered 1 through 10 and are color coded for visualization. Motifs discovered in the summary MEME analysis were conservatively excluded to limit the number of false-positive motif placements. The location of the predicted globular domain of the protein is denoted by the *green hatched bars*. Note that motif 1 is located in the putative globular domain in all the groups.

A second protein, $U_s1.5$, which plays a role in the host range of the virus, is involved in optimal expression of ICP0 and γ -genes and is distributed differently in infected cells compared with $\alpha 22$.^{56,78} It is encoded within the U_s1 gene, and is identical with the carboxyl terminus of the $\alpha 22$ protein.^{54,78} Thus, the clustering of multiple functions in the C-terminal half of the protein and the presence of an overlapping protein could also explain the higher sequence conservation in this part of the $\alpha 22$ protein compared with the amino-terminal third. The potential effects of sequence variability on the function, or functions, of the $U_s1.5$ protein depend on the start site. Currently, three start sites—M90, M147, and M171—have been reported for the $U_s1.5$ protein, and it is unclear whether all three sites are used or whether the start site differs between strains.^{52–54} Based on the reduced variability in the C-terminal half of the sequence, if $U_s1.5$ begins at residue 147 or 171,^{52,53} the variability would have less effect. However, if translation of $U_s1.5$ begins as residue 90,⁵⁴ then the sequence variability would be greater and may affect the function of the $U_s1.5$ protein. Additional studies are clearly required.

The S34A and Y116C changes in OD4 had previously been shown to be partially responsible for the attenuation of strain OD4 in ocular infections.^{25,26} Six of the strains—KOS, OD4, TFT401, CJ994, R-15, and HF-10—had the S34A sequence change. However, both changes were required for the loss of virulence in strain OD4; thus, the presence of only S34A would not be expected to change ocular virulence. However, KOS had both changes and causes keratitis.⁵⁹ There are several possible explanations for this apparent discrepancy. One we

currently favor is related to observations that the $\alpha 22$ protein interacts with multiple viral and cellular proteins (see Introduction) and that its role in virulence very likely depends on at least some of these interactions. This may be an example of epistasis or, more specifically, sign epistasis, in which the phenotype of a particular mutation depends on the context in which it is expressed.⁷⁹ Sequence changes in other KOS proteins could compensate for the U_s1 changes and maintain virulence. The KOS U_s1 protein also has an additional sequence difference compared to OD4 (A10V), and this could be compensatory. Additional studies with KOS and OD4 are needed to address this issue.

The HSV-1 strains could be separated into three groups or clades. Previous phylogenetic analyses using the HSV-1 gC, gG, gE, and gI genes also indicated that there were three clades.^{73,74} However, the clades identified using the gC, gG, gE, and gI genes were not the same as those identified using the U_s1 gene. For example, strains F and 17 were in the same clade based on U_s1 sequences, but they sorted in different clades based on the gE/gI sequences. The differences in clade structure seen when analyzing single genes or a small subset of genes point to a weakness with this approach because it may bias the actual genetic relationships between the strains. The most likely explanation is that this is the result of recombination events between strains, but further work is needed to confirm this.

The MEME analysis, which identifies phylogenetically useful motifs, revealed a number of interesting structural features in the $\alpha 22$ protein. First, unique patterns of motifs were identified

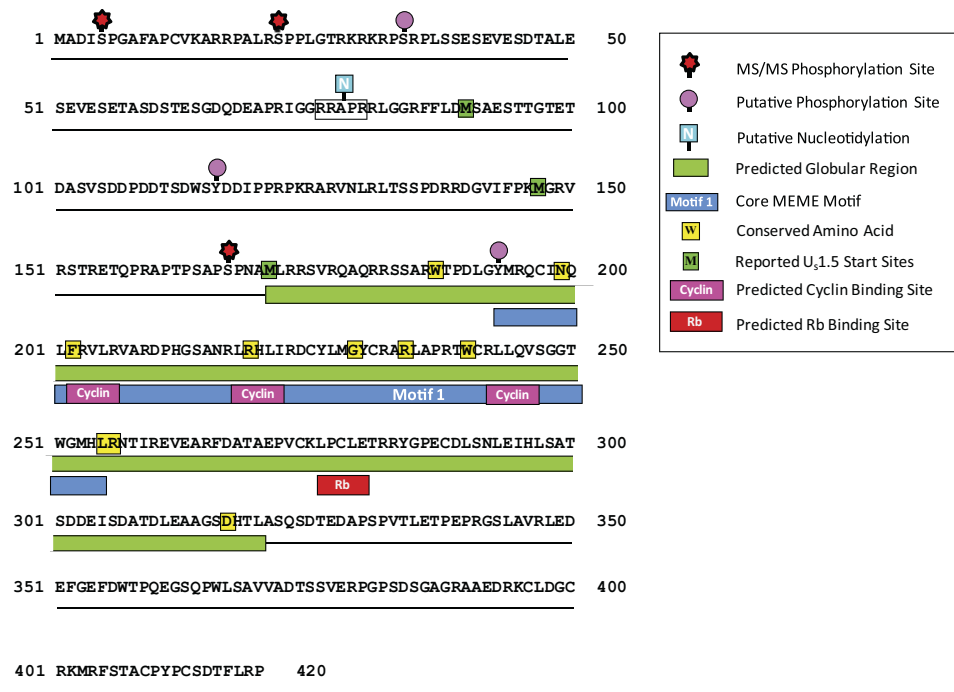

FIGURE 6. Schematic diagram of the HSV-1 α 22 protein showing predicted and confirmed phosphorylation sites (unpublished data, 2010), the location of MEME motif 1, structural features and consensus sequence motifs, predicted functional regions, and amino acid residues that are conserved in all the strains analyzed. Note that we have shown all three of the reported start sites for the U_s1.5 protein. The legend denotes features that have been experimentally confirmed versus those that are predicted.

for the human viruses, Old World monkey viruses, and the varicella viruses. For example, motifs 4, 7, and 9 were unique to HSV-1 and HSV-HG52, which would be expected given their close evolutionary relationship. Some motifs are predominantly cationic whereas others are primarily anionic. Several of the motifs were hydrophobic. Hydrophobic residues tend to be conserved in regions involved in folding and the maintenance of the tertiary structure, suggesting that these motifs might be important for stabilizing the α 22 protein structure. As revealed in Figure 4, each of the motifs has several highly conserved residues, and these motifs can now serve as the focus of mutational studies to determine structure-function relationships in the α 22 protein.

The analysis also identified a motif (motif 1) that was conserved in all α -herpesvirus U_s1 homologs. Motif 1, which has 63 residues, was contained within a larger region previously identified as conserved across the α -herpesvirus subfamily.^{57,80} Thus, our analysis more precisely defines this core conserved sequence. We identified several residues using the ClustalW alignment program (Supplementary Fig. S1, <http://www.iovs.org/lookup/suppl/doi:10.1167/iovs.10-7032/-/DCSupplemental>) that are absolutely conserved in the U_s1 homologs analyzed, including W187, N198, F202, R219, G229, R234, W240, L255, R256, and D317, which were located in the predicted globular domain (Fig. 6). The conservation of residues within this region would be consistent with it functioning as a conserved core or scaffold for variable amino- and carboxyl-terminal domains.

When we applied the protein folding program GlobPlot2 to the HSV-1 α 22 sequence, we found that only the very central region was predicted to fold into a globular domain and that motif 1 was centered in this region. This behavior is characteristic of proteins that can adopt alternative conformations that are regulated by posttranslational modification such as phosphorylation.⁸¹ The fact that the α 22 protein has multiple functions, is present in at least seven or eight isoforms in infected cells, and is phosphorylated would be consistent with such behavior. We propose that the U_s1 protein consists of a central core scaffold region centered on motif 1 that has amino- and carboxyl-terminal domains that can adopt different conformations,

depending on specific posttranslational modifications. These different conformers would then carry out specific functions.

As shown in Figure 6, we compiled the available data on the structural features of the HSV-1 α 22 protein. This analysis reveals a number of important features and serves as a guide for site-directed mutagenesis studies. We included both predicted and confirmed modification sites, recognizing that additional studies using physical methods are needed to confirm modification sites. Note that the phosphorylation of serines 5, 22, and 167 have been confirmed using ms/ms (Hermann Bultmann and Curtis Brandt, unpublished data, 2010). Predicted cyclin and Rb protein binding sites were identified and reside in the central globular region. The presence of cyclin binding sites is consistent with previous reports that α 22 interacts with CDK9.^{27,82}

In summary, for the first time, we show that there is significant sequence variability in the HSV-1 α 22 protein and that most of the variability lies in the amino-terminal third of the protein. We have also identified 10 conserved residues in the protein and that a core 63 amino acid sequence is located in the central part of the α 22 protein. This information is critical for designing targeted mutational studies of the structure and function of the α 22 protein and its role in virulence.

Acknowledgments

The authors thank John Chandler for providing the ocular viral isolates.

References

- Liesegang TJ. Herpes simplex virus epidemiology and ocular importance. *Cornea*. 2001;20:1-13.
- Whitley RJ. Herpes simplex viruses. In: Fields BN, Knipe DM, Howley PM, eds. *Fields Virology*. Philadelphia: Lippincott-Raven; 1996:2297-2342.
- Bhattacharjee PS, Neumann DM, Foster TP, et al. Effect of human apolipoprotein E genotype on the pathogenesis of experimental ocular HSV-1. *Exp Eye Res*. 2008;87:122-130.
- Burgos JS, Ramirez C, Sastre I, Valdivieso F. Effect of apolipoprotein E on the cerebral load of latent herpes simplex virus type 1 DNA. *J Virol*. 2006;80:5383-5387.

5. Han X, Lundberg P, Tanamachi B, Openshaw H, Longmate J, Cantin E. Gender influences herpes simplex virus type 1 infection in normal and gamma interferon-mutant mice. *J Virol.* 2001;75:3048–3052.
6. Kastrukoff LF, Lau AS, Puterman ML. Genetics of natural resistance to herpes simplex virus type 1 latent infection of the peripheral nervous system in mice. *J Gen Virol.* 1986;67(pt 4):613–621.
7. Lopez C. Genetics of natural resistance to herpesvirus infections in mice. *Nature.* 1975;258:152–153.
8. Lundberg P, Welander P, Openshaw H, et al. A locus on mouse chromosome 6 that determines resistance to herpes simplex virus also influences reactivation, while an unlinked locus augments resistance of female mice. *J Virol.* 2003;77:11661–11673.
9. Snyder A, Polcicova K, Johnson DC. Herpes simplex virus gE/gI and US9 proteins promote transport of both capsids and virion glycoproteins in neuronal axons. *J Virol.* 2008;82:10613–10624.
10. Stulting RD, Kindle JC, Nahmias AJ. Patterns of herpes simplex keratitis in inbred mice. *Invest Ophthalmol Vis Sci.* 1985;26:1360–1367.
11. Zhang SY, Jouanguy E, Ugolini S, et al. TLR3 deficiency in patients with herpes simplex encephalitis. *Science.* 2007;317:1522–1527.
12. Koelle DM, Corey L. Recent progress in herpes simplex virus immunobiology and vaccine research. *Clin Microbiol Rev.* 2003;16:96–113.
13. Pollara G, Katz DR, Chain BM. The host response to herpes simplex virus infection. *Curr Opin Infect Dis.* 2004;17:199–203.
14. Sørensen LN, Reinert LS, Malmgaard L, Bartholdy C, Thomsen AR, Paludan SR. TLR2 and TLR9 synergistically control herpes simplex virus infection in the brain. *J Immunol.* 2008;181:8604–8612.
15. Doymaz MZ, Rouse BT. Immunopathology of herpes simplex virus infections. *Curr Top Microbiol Immunol.* 1992;179:121–136.
16. Streilein JW, Dana MR, Ksander BR. Immunity causing blindness: five different paths to herpes stromal keratitis. *Immunol Today.* 1997;18:443–449.
17. Thomas J, Rouse BT. Immunopathogenesis of herpetic ocular disease. *Immunol Res.* 1997;16:375–386.
18. Brandt CR. Virulence genes in herpes simplex virus type 1 corneal infection. *Curr Eye Res.* 2004;29:103–117.
19. Brandt CR. The role of viral and host genes in corneal infection with herpes simplex virus type 1. *Exp Eye Res.* 2005;80:607–621.
20. McGeoch DJ, Dalrymple MA, Davison AJ, et al. The complete DNA sequence of the long unique region in the genome of herpes simplex virus type 1. *J Gen Virol.* 1988;69(pt 7):1531–1574.
21. McGeoch DJ, Dolan A, Donald S, Brauer DH. Complete DNA sequence of the short repeat region in the genome of herpes simplex virus type 1. *Nucleic Acids Res.* 1986;14:1727–1745.
22. McGeoch DJ, Dolan A, Donald S, Rixon FJ. Sequence determination and genetic content of the short unique region in the genome of herpes simplex virus type 1. *J Mol Biol.* 1985;181:1–13.
23. Perry IJ, McGeoch DJ. The DNA sequences of the long repeat region and adjoining parts of the long unique region in the genome of herpes-simplex virus type-1. *J Gen Virol.* 1988;69:2831–2846.
24. Szpara ML, Parsons L, Enquist LW. Sequence variability in clinical and laboratory isolates of herpes simplex virus 1 reveals new mutations. *J Virol.* 2010;84:5303–5313.
25. Brandt CR, Kolb AW. Tyrosine 116 of the herpes simplex virus type 1 IE α 22 protein is an ocular virulence determinant and potential phosphorylation site. *Invest Ophthalmol Vis Sci.* 2003;44:4601–4607.
26. Brandt CR, Kolb AW, Shah DD, et al. Multiple determinants contribute to the virulence of HSV ocular and CNS infection and identification of serine 34 of the US1 gene as an ocular disease determinant. *Invest Ophthalmol Vis Sci.* 2003;44:2657–2668.
27. Durand LO, Advani SJ, Poon AP, Roizman B. The carboxyl-terminal domain of RNA polymerase II is phosphorylated by a complex containing cdk9 and infected-cell protein 22 of herpes simplex virus 1. *J Virol.* 2005;79:6757–6762.
28. Fraser KA, Rice SA. Herpes simplex virus immediate-early protein ICP22 triggers loss of serine 2-phosphorylated RNA polymerase II. *J Virol.* 2007;81:5091–5101.
29. Jenkins HL, Spencer CA. RNA polymerase II holoenzyme modifications accompany transcription reprogramming in herpes simplex virus type 1-infected cells. *J Virol.* 2001;75:9872–9884.
30. Long MC, Leong V, Schaffer PA, Spencer CA, Rice SA. ICP22 and the UL13 protein kinase are both required for herpes simplex virus-induced modification of the large subunit of RNA polymerase II. *J Virol.* 1999;73:5593–5604.
31. Rice SA, Long MC, Lam V, Schaffer PA, Spencer CA. Herpes-simplex virus immediate-early protein ICP22 is required for viral modification of host RNA-polymerase-II and establishment of the normal viral transcription program. *J Virol.* 1995;69:5550–5559.
32. Markovitz NS, Roizman B. Small dense nuclear bodies are the site of localization of herpes simplex virus 1 U(L)3 and U(L)4 proteins and of ICP22 only when the latter protein is present. *J Virol.* 2000;74:523–528.
33. Ng TI, Chang YE, Roizman B. Infected cell protein 22 of herpes simplex virus 1 regulates the expression of virion host shutoff gene U(L)41. *Virology.* 1997;234:226–234.
34. Poffenberger KL, Raichlen PE, Herman RC. In vitro characterization of a herpes simplex virus type 1 ICP22 deletion mutant. *Virus Genes.* 1993;7:171–186.
35. Poon APW, Roizman B. Herpes simplex virus 1 ICP22 regulates the accumulation of a shorter mRNA and of a truncated U(S)3 protein kinase that exhibits altered functions. *J Virol.* 2005;79:8470–8479.
36. Purves FC, Ogle WO, Roizman B. Processing of the herpes simplex virus regulatory protein alpha 22 mediated by the UL13 protein kinase determines the accumulation of a subset of alpha and gamma mRNAs and proteins in infected cells. *Proc Natl Acad Sci U S A.* 1993;90:6701–6705.
37. Orlando JS, Balliet JW, Kushnir AS, et al. ICP22 is required for wild-type composition and infectivity of herpes simplex virus type 1 virions. *J Virol.* 2006b;80:9381–9390.
38. Bowman JJ, Orlando JS, Davido DJ, Kushnir AS, Schaffer PA. Transient expression of herpes simplex virus type 1 ICP22 represses viral promoter activity and complements the replication of an ICP22 null virus. *J Virol.* 2009a;83:8733–8743.
39. Prod'hon C, Machuca I, Berthomme H, Epstein A, Jacquemont B. Characterization of regulatory functions of the HSV-1 immediate-early protein ICP22. *Virology.* 1996;226:393–402.
40. Barcy S, Corey L. Herpes simplex inhibits the capacity of lymphoblastoid B cell lines to stimulate CD4+ T cells. *J Immunol.* 2001;166:6242–6249.
41. Bruni R, Fineschi B, Ogle WO, Roizman B. A novel cellular protein, p60, interacting with both herpes simplex virus 1 regulatory proteins ICP22 and ICP0 is modified in a cell-type-specific manner and is recruited to the nucleus after infection. *J Virol.* 1999;73:3810–3817.
42. Bruni R, Roizman B. Herpes simplex virus 1 regulatory protein ICP22 interacts with a new cell cycle-regulated factor and accumulates in a cell cycle-dependent fashion in infected cells. *J Virol.* 1998;72:8525–8531.
43. Jahedi S, Markovitz NS, Filatov F, Roizman B. Colocalization of the herpes simplex virus 1 UL4 protein with infected cell protein 22 in small, dense nuclear structures formed prior to onset of DNA synthesis. *J Virol.* 1999;73:5132–5138.
44. Leopardi R, Ward PL, Ogle WO, Roizman B. Association of herpes simplex virus regulatory protein ICP22 with transcriptional complexes containing EAP, ICP4, RNA polymerase II, and viral DNA requires posttranslational modification by the U(L)13 protein kinase. *J Virol.* 1997;71:1133–1139.
45. Smith-Donald BA, Roizman B. The interaction of herpes simplex virus 1 regulatory protein ICP22 with the cdc25C phosphatase is enabled in vitro by viral protein kinases US3 and UL13. *J Virol.* 2008;82:4533–4543.
46. Orlando JS, Astor TL, Rundle SA, Schaffer PA. The products of the herpes simplex virus type 1 immediate-early US1/US1.5 genes downregulate levels of S-phase-specific cyclins and facilitate virus replication in S-phase Vero cells. *J Virol.* 2006a;80:4005–4016.
47. Blaho JA, Mitchell C, Roizman B. Guanylation and adenylation of the alpha regulatory proteins of herpes simplex virus require a viral beta or gamma function. *J Virol.* 1993;67:3891–3900.
48. Blaho JA, Zong CS, Mortimer KA. Tyrosine phosphorylation of the herpes simplex virus type 1 regulatory protein ICP22 and a cellular

- protein which shares antigenic determinants with ICP22. *J Virol.* 1997;71:9828-9832.
49. Mitchell C, Blaho JA, McCormick AL, Roizman B. The nucleotidylation of herpes simplex virus 1 regulatory protein alpha22 by human casein kinase II. *J Biol Chem.* 1997;272:25394-25400.
 50. Mitchell C, Blaho JA, Roizman B. Casein kinase II specifically nucleotidylates in vitro the amino acid sequence of the protein encoded by the alpha 22 gene of herpes simplex virus 1. *Proc Natl Acad Sci U S A.* 1994;91:11864-11868.
 51. O'Toole JM, Aubert M, Kotsakis A, Blaho JA. Mutation of the protein tyrosine kinase consensus site in the herpes simplex virus 1 alpha22 gene alters ICP22 posttranslational modification. *Virology.* 2003;305:153-167.
 52. Poon APW, Ogle WO, Roizman B. Posttranslational processing of infected cell protein 22 mediated by viral protein kinases is sensitive to amino acid substitutions at distant sites and can be cell-type specific. *J Virol.* 2000;74:11210-11214.
 53. Ogle WO, Roizman B. Functional anatomy of herpes simplex virus 1 overlapping genes encoding infected-cell protein 22 and US1.5 protein. *J Virol.* 1999;73:4305-4315.
 54. Bowman JJ, Schaffer PA. Origin of expression of the herpes simplex virus type 1 protein U(S)1.5. *J Virol.* 2009b;83:9183-9194.
 55. Hagglund R, Munger J, Poon APW, Roizman B. US3 protein kinase of herpes simplex virus 1 blocks caspase 3 activation induced by the products of US1.5 and UL13 genes and modulates expression of transduced US1.5 open reading frame in a cell type-specific manner. *J Virol.* 2002;76:743-754.
 56. Cun W, Hong M, Liu LD, Dong CH, Luo J, Li QH. Structural and functional characterization of herpes simplex virus 1 immediate-early protein infected-cell protein 22. *J Biochem.* 2006;140:67-73.
 57. Bastian TW, Rice SA. Identification of sequences in herpes simplex virus type 1 ICP22 that influence RNA polymerase II modification and viral late gene expression. *J Virol.* 2009;83:128-139.
 58. Bastian TW, Livingston CM, Weller SK, Rice SA. Herpes simplex virus type 1 immediate-early protein ICP22 is required for VICE domain formation during productive viral infection. *J Virol.* 2010;84:2384-2394.
 59. Grau DR, Visalli RJ, Brandt CR. Herpes simplex virus stromal keratitis is not titer-dependent and does not correlate with neurovirulence. *Invest Ophthalmol Vis Sci.* 1989;30:2474-2480.
 60. Brandt CR, Grau DR. Mixed infection with herpes simplex virus type 1 generates recombinants with increased ocular and neurovirulence. *Invest Ophthalmol Vis Sci.* 1990;31:2214-2223.
 61. Sedarati F, Stevens JG. Biological basis for virulence of three strains of herpes simplex virus type 1. *J Gen Virol.* 1987;68(pt 9):2389-2395.
 62. Kintner RL, Brandt CR. Rapid small-scale isolation of herpes simplex virus DNA. *J Virol Methods.* 1994;48:189-196.
 63. Larkin MA, Blackshields G, Brown NP, et al. Clustal W and Clustal X version 2.0. *Bioinformatics.* 2007;23:2947-2948.
 64. Tamura K, Dudley J, Nei M, Kumar S. MEGA4: molecular evolutionary genetics analysis (MEGA) software version 4.0. *Mol Biol Evol.* 2007;24:1596-1599.
 65. Saitou N, Nei M. The neighbor-joining method: a new method for reconstructing phylogenetic trees. *Mol Biol Evol.* 1987;4:406-425.
 66. Kimura M. A simple method for estimating evolutionary rates of base substitutions through comparative studies of nucleotide sequences. *J Mol Evol.* 1980;16:111-120.
 67. Felsenstein J. Confidence limits on phylogenies—an approach using the bootstrap. *Evolution.* 1985;39:783-791.
 68. Jones DT, Taylor WR, Thornton JM. The rapid generation of mutation data matrices from protein sequences. *Comput Appl Biosci.* 1992;8:275-282.
 69. Bailey TL, Elkan C. Unsupervised learning of multiple motifs in biopolymers using expectation maximization. *Machine Learning.* 1995;21:51-80.
 70. Korber B. Computational analysis of HIV molecular sequences. In: Rodrigo AG, Learn GH, eds. *HIV Signature and Sequence Variation Analysis.* Dordrecht, Netherlands: Kluwer Academic Publishers. 2000;55-72.
 71. Linding R, Russell RB, Neduva V, Gibson TJ. GlobPlot: exploring protein sequences for globularity and disorder. *Nucleic Acids Res.* 2003;31:3701-3708.
 72. Puntervoll P, Linding R, Gemund C, et al. ELM server: a new resource for investigating short functional sites in modular eukaryotic proteins. *Nucleic Acids Res.* 2003;31:3625-3630.
 73. Trybala E, Roth A, Johansson M, et al. Glycosaminoglycan-binding ability is a feature of wild-type strains of herpes simplex virus type 1. *Virology.* 2002;302:413-419.
 74. Norberg P, Bergstrom T, Rekabdar E, Lindh M, Lijeqvist J. Phylogenetic analysis of clinical herpes simplex virus type 1 isolates identified three genetic groups and recombinant viruses. *J Virol.* 2004;78:10755-10764.
 75. Poffenberger KL, Idowu AD, Fraser-Smith EB, Raichlen PE, Herman RC. A herpes simplex virus type 1 ICP22 deletion mutant is altered for virulence and latency in vivo. *Arch Virol.* 1994;139:111-119.
 76. Sears AE, Halliburton IW, Meignier B, Silver S, Roizman B. Herpes simplex virus 1 mutant deleted in the alpha 22 gene: growth and gene expression in permissive and restrictive cells and establishment of latency in mice. *J Virol.* 1985a;55:338-346.
 77. Sears AE, Roizman B. Cell-specific selection of mutants of a herpes simplex virus recombinant carrying deletions. *Virology.* 1985b;145:176-180.
 78. Carter KL, Roizman B. The promoter and transcriptional unit of a novel herpes simplex virus 1 alpha gene are contained in, and encode a protein in frame with, the open reading frame of the alpha 22 gene. *J Virol.* 1996;70:172-178.
 79. Phillips PC. Epistasis—the essential role of gene interactions in the structure and evolution of genetic systems. *Nat Rev Genet.* 2008;9:855-867.
 80. Schwyzer M, Wirth UV, Vogt B, Fraefel C. BICP22 of bovine herpesvirus 1 is encoded by a spliced 1.7 kb RNA which exhibits immediate early and late transcription kinetics. *J Gen Virol.* 1994;75(pt 7):1703-1711.
 81. Redfield C. Using nuclear magnetic resonance spectroscopy to study molten globule states of proteins. *Methods.* 2004;34:121-132.
 82. Durand LO, Roizman B. Role of cdk9 in the optimization of expression of the genes regulated by ICP22 of Herpes simplex virus 1. *J Virol.* 2008;82:10591-10599.